

NOT MEASUREMENT
SENSITIVE

MIL-STD-810F
1 January 2000
SUPERSEDING
MIL-STD-810E
14 JULY 1989

DEPARTMENT OF DEFENSE
TEST METHOD STANDARD
FOR



ENVIRONMENTAL ENGINEERING CONSIDERATIONS
AND LABORATORY TESTS

AMSC N/A

AREA ENVR

DISTRIBUTION STATEMENT A: Approved for public release; distribution is unlimited.

MIL-STD-810F
1 January 2000

FOREWORD

This test method standard is approved for use by all Departments and Agencies of the Department of Defense (DoD). Although prepared specifically for DoD applications, this standard may be tailored for commercial applications as well. MIL-STD-810F is a significant revision of MIL-STD-810E. Much of the standard is rewritten completely to provide clearer direction. The primary emphases are still the same -- tailoring a materiel item's environmental design and test limits to the conditions that the specific materiel will experience throughout its service life, and establishing laboratory test methods that replicate the effects of environments on materiel rather than trying to reproduce the environments themselves. However, the "F" revision has been expanded significantly up front to explain how to implement the environmental tailoring process throughout the materiel acquisition cycle.

This revision recognizes that the environmental design and test tailoring process has expanded to involve a wide range of managerial and technical interests. Accordingly, this revision orients environmental design and test direction toward three basic types of users who have distinctly different, although closely associated, interests: program managers who, among other responsibilities, ensure proposed concepts and systems are valid and functional in intended operational environments; environmental engineering specialists (EES), who enter the acquisition process early to assist combat and materiel developer tailoring efforts by preparing life cycle environmental profiles and drafting tailored design criteria and test programs, and the design, test, and evaluation community, whose analysts, engineers, and facility operators use tailored designs and tests to meet user needs.

The most visible difference in the "F" revision is that the overall document is in two parts.

Part One describes management, engineering, and technical roles in the environmental design and test tailoring process. It focuses on the process of tailoring materiel design and test criteria to the specific environmental conditions a materiel item is likely to encounter during its service life. New appendices support the succinctly presented text of Part One. Appendix A contains complete descriptions of environmental engineering tasks. These tasks, along with management information in Appendix B and EES guidance in Appendix C, will help to ensure the environmental design and test tailoring process is implemented and documented according to the disciplined, but flexible approach to materiel acquisition called for in Department of Defense (DoD) 5000-series documents (DoD 5000.1, A.4). Terms used in this standard relating to the materiel acquisition process are limited to terms used in the DoD 5000-series documents; to avoid confusion and promote simplicity, service-specific terms/processes are not used.

Part Two contains environmental laboratory test methods to be applied according to the general and specific test tailoring guidelines described in Part One. It is important to emphasize that these methods are not to be called out in blanket fashion nor applied as unalterable routines, but are to be selected and tailored to generate the most relevant test data possible.

To support the tailoring process described in Part One, each test method in Part Two contains some environmental data and references, and identifies tailoring opportunities for the particular method. Some methods afford a wide latitude for tailoring; some can be tailored up to established limits, and some have relatively few tailoring options. Whenever possible, each method contains background rationale to help determine the appropriate level of tailoring. Each test method supports the test engineer and test facility operator by describing preferred laboratory test facilities and methodologies. Any specific tailoring information and values contained in these test methods should be supplanted by more up-to-date or program-specific information when available.

When applied properly, the environmental management and engineering processes described in this standard can be of enormous value in generating confidence in the environmental worthiness and overall durability of materiel system design. However, it is important to recognize that there are limitations inherent in laboratory testing that make it imperative to use proper caution and engineering judgement when extrapolating these laboratory results to results that may be obtained under actual service conditions. In many cases, real-world environmental stresses (singularly or in combination) cannot be duplicated practically or reliably in test laboratories. Therefore, users

should not assume that a system or component that passes laboratory tests of this standard also would pass field/fleet verification trials.

The US Department of Defense would like to thank the following individuals for their contributions toward the development and publication of MIL-STD-810F:

| | |
|---|---|
| Anderson, Andy – United Defense | Merritt, Ron – US Navy, Naval Air Warfare Center |
| Bair, Jim – US Air Force, Wright-Patterson AFB | Moriceau, Jacques – LRBA, France |
| Bell, Dwayne – US Air Force, Eglin AFB | Moss, Ron – Ordnance Board, United Kingdom |
| Caruso, Hank – G's and Degrees | Sullivan, Jamie – US Army, Redstone Technical Test Center |
| Connon, Skip – US Army, Aberdeen Test Center | Tanner, Steve – US Navy, Naval Air Warfare Center |
| Egbert, Herb – US Army Developmental Test Command | Walton, Scott – US Army, Aberdeen Test Center |
| Galloway, Judy – US Army, Aberdeen Test Center | Weaver, Earl – US Air Force, Wright-Patterson AFB |
| Henry, Connie – US Air Force, Wright-Patterson AFB | Williamson, Roger – US Army Test and Evaluation Command |
| MacMartin, Dave – National Defence Headquarters, Canada | |

Also, a special thank you to Herb Egbert, Chairman of the MIL-STD-810 revision committee for his leadership, dedication, and perseverance in revising this document.

This standard is intended to be a "living document" that will be updated as new concepts, technologies, and methodologies evolve. Address beneficial comments (recommended changes, additions, deletions) along with clear, supporting rationale and any pertinent data that may improve this document to: ASC/ENOI, Bldg. 560, 2530 Loop Road West, Wright-Patterson AFB OH 45433-7101. Use the Standardization Document Improvement Proposal (DD Form 1426) appearing at the end of this document or send a letter detailing the paragraph/page number, recommended wording, and reason/rationale for the recommendation.

Address technical questions to the following offices:

Aeronautical Systems Center, ATTN: ASC/ENFS, 2530 Loop Road West, Wright-Patterson AFB OH 45433-7101; Commercial Tel: (937) 255-8357/8596; DSN 785-8357/8596; Fax: (937) 476-4546.

Naval Air Warfare Center, Weapons Division, ATTN: Code 476400D, China Lake CA 93555-6100; Commercial Tel: (619) 939-4667; DSN 437-4667; Fax: (619) 939-1065.

US Army Developmental Test Command, 314 Longs Corner Road, ATTN: CSTE-DTC-TT-M, Aberdeen Proving Ground MD 21005-5055; Commercial Tel: (410) 278-1476; DSN 298-1476; Fax: (410) 278-4243/1475.

MIL-STD-810F
1 January 2000

THIS PAGE INTENTIONALLY BLANK

PART ONE -- ENVIRONMENTAL ENGINEERING PROGRAM GUIDELINES**TABLE OF CONTENTS**

| Paragraph | Page |
|--|-----------|
| 1. SCOPE..... | 1 |
| 1.1 Purpose..... | 1 |
| 1.2 Application..... | 1 |
| 1.3 Limitations..... | 2 |
| 2. APPLICABLE DOCUMENTS..... | 3 |
| 2.1 General..... | 3 |
| 2.2 Government Documents..... | 3 |
| 2.2.1 Standards..... | 3 |
| 2.2.2 Other government documents..... | 3 |
| 2.3 Non-government Documents..... | 3 |
| 2.4 Order of Precedence..... | 4 |
| 3. TERMINOLOGY..... | 4 |
| 4. GENERAL PROGRAM GUIDELINES..... | 7 |
| 4.1 Program Managers..... | 7 |
| 4.1.1 Roles of the program manager..... | 7 |
| 4.1.2 Guidance for program managers..... | 7 |
| 4.1.2.1 Mission Need Statement (MNS)..... | 8 |
| 4.1.2.2 Operational Requirements Document (ORD)..... | 8 |
| 4.1.2.3 Systems Engineering Management Plan (SEMP)..... | 9 |
| 4.1.2.4 Test and Evaluation Master Plan (TEMP)..... | 9 |
| 4.1.2.5 Cost and Operational Effectiveness Analysis (COEA)..... | 9 |
| 4.2 Environmental Engineering Specialists (EES)..... | 9 |
| 4.2.1 Roles of environmental engineering specialists..... | 9 |
| 4.2.2 Environmental engineering tailoring tasks..... | 10 |
| 4.2.2.1 General..... | 10 |
| 4.2.2.2 Preparing an Environmental Engineering Management Plan (EEMP), Task 401..... | 10 |
| 4.2.2.3 Developing an Environmental Test and Evaluation Master Plan (ETEMP)..... | 10 |
| 4.2.2.3.1 Defining a Life Cycle Environmental Profile (LCEP), Task 402..... | 10 |
| 4.2.2.3.2 Developing Operational Environment Documentation (OED), Task 403..... | 10 |
| 4.2.2.3.3 Developing an Environmental Issues/Criteria List (EICL), Task 404..... | 11 |
| 4.2.2.4 Preparing a Detailed Environmental Test Plan (DETP), Task 405..... | 11 |
| 4.2.2.5 Preparing an Environmental Test Report (ETR), Task 406..... | 11 |
| 4.3 Design and Test Engineers and Facility Operators..... | 11 |
| 4.3.1 Roles of design engineers..... | 11 |
| 4.3.2 Roles of test engineers/facility operators..... | 11 |
| 4.3.3 Guidance for design and test engineers and test facility operators..... | 12 |
| 4.3.3.1 Natural environment (field/fleet) testing..... | 12 |
| 4.3.3.2 Laboratory testing..... | 12 |
| 5. GENERAL LABORATORY TEST METHOD GUIDELINES..... | 15 |
| 5.1 Standard Ambient Test Conditions..... | 15 |
| 5.2 Tolerances for Test Conditions..... | 15 |

MIL-STD-810F
1 January 2000

TABLE OF CONTENTS (CONT'D).

| Paragraph | Page |
|-----------|--|
| 5.3 | Test Instrumentation. 16 |
| 5.3.1 | Suitability for environment. 16 |
| 5.3.2 | Calibration. 16 |
| 5.4 | Stabilizing Test Temperature. 16 |
| 5.4.1 | Test item operating. 16 |
| 5.4.2 | Test item non-operating. 16 |
| 5.5 | Test Sequence. 16 |
| 5.6 | Test Level Derivation. 17 |
| 5.7 | Pretest Information for Facility Operators. 17 |
| 5.8 | Test Setup. 17 |
| 5.8.1 | Installing the test item in test facility. 17 |
| 5.8.2 | Test item operation. 17 |
| 5.9 | Pretest Baseline Data. 18 |
| 5.10 | Information During Test. 18 |
| 5.11 | Interrupted Tests. 18 |
| 5.11.1 | In-tolerance interruptions. 18 |
| 5.11.2 | Out-of-tolerance interruptions for methods 503, 506, 510, 511, 514, 515, 516, 517, 519, 522, and 523. 18 |
| 5.11.3 | Out-of-tolerance interruptions for methods 500, 501, 502, 504, 505, 507, 508, 509, 512, 513, 518, 520, and 521. 19 |
| 5.12 | Combined Tests. 19 |
| 5.13 | Post-test Data. 19 |
| 5.14 | Environmental Effects and Failure Criteria. 21 |
| 5.15 | Environmental Test Reports. 21 |
| 5.16 | Water Purity. 21 |
| 5.17 | Analysis of Results. 21 |
| 5.18 | Monitoring. 22 |
| 5.18.1 | Monitoring test chamber parameters. 22 |
| 5.18.2 | Monitoring the item under test. 22 |
| 6. | NOTES..... 23 |
| 6.1 | Intended Use. 23 |
| 6.2 | Issue of DoDISS. 23 |
| 6.3 | Subject Term (key word) Listing (Also see, Subject Index, page Index -1). 23 |
| 6.4 | International Standardization Agreement. 23 |
| 6.5 | Changes from Previous Issue. 24 |

FIGURES

| | |
|------|--|
| 1-1 | Environmental engineering program guide viii |
| 1-2 | Roles of acquisition personnel in environmental design/test tailoring process 2 |
| 4-1 | Environmental test program tailoring process. 8 |
| 4-2a | Generalized life cycle histories for military hardware 13 |
| 4-2b | Generalized life cycle histories for military hardware 14 |
| 5-1 | Interrupted test cycle logic, Method 503, 506, 510, 511, 514, 516, 517, 519, 522, and 523 20 |

TABLE OF CONTENTS – Continued

| | | |
|--|---|---------------------|
| APPENDIX | | Page |
| A | Environmental Management and Engineering Tasks | A-1 |
| B | Detailed Program Management Guidance | B-1 |
| C | Environmental Tailoring Guidelines for Environmental Engineering Specialists (EES) | C-1 |
| D | Terminology for Dynamic (Mechanical) Test Methods..... | D-1 |
| APPENDIX FIGURE | | |
| C-1 | Areas of occurrence of climatic categories | C-5 |
| APPENDIX TABLE | | |
| C-1 | Summary of climatic conditions and daily cycles of temperature, solar radiation, and relative humidity | C-6 |
| Subject Index (for Part One) | | Index -1 |
| PART TWO -- LABORATORY TEST METHODS | | Part Two-1 |
| 500.4 | Low Pressure (Altitude) | 500.4-1 - 500.4-8 |
| 501.4 | High Temperature | 501.4-1 - 501.4-12 |
| 502.4 | Low Temperature | 502.4-1 - 502.4-10 |
| 503.4 | Temperature Shock | 503.4-1 - 503.4-10 |
| 504 | Contamination by Fluids | 504-1- 504A-2 |
| 505.4 | Solar Radiation (Sunshine) | 505.4-1 - 505.4A-8 |
| 506.4 | Rain | 506.4-1 - 506.4-12 |
| 507.4 | Humidity | 507.4-1 - 507.4A-2 |
| 508.5 | Fungus | 508.5-1 - 508.5-12 |
| 509.4 | Salt Fog | 509.4-1 - 509.4-10 |
| 510.4 | Sand and Dust | 510.4-1 - 510.4-12 |
| 511.4 | Explosive Atmosphere | 511.4-1 - 511.4-6 |
| 512.4 | Immersion | 512.4-1 - 512.4-8 |
| 513.5 | Acceleration | 513.5-1 - 513.5-14 |
| 514.5 | Vibration | 514.5-i - 514.5C-16 |
| 515.5 | Acoustic Noise | 515.5-i - 515.5B-2 |
| 516.5 | Shock | 516.5-i - 516.5C-4 |
| 517 | Pyroshock | 517-1 - 517-24 |
| 518 | Acidic Atmosphere | 518-1 - 518-6 |
| 519.5 | Gunfire Vibration..... | 519.5-i - 519.5D-10 |
| 520.2 | Temperature, Humidity, Vibration, and Altitude | 520.2-1 - 520.2A-10 |
| 521.2 | Icing/Freezing Rain | 521.2-1 - 521.2-8 |
| 522 | Ballistic Shock | 522-1 - 522-14 |
| 523.2 | Vibro-Acoustic/Temperature | 523.2-1 - 523.2A-8 |

MIL-STD-810F
1 January 2000

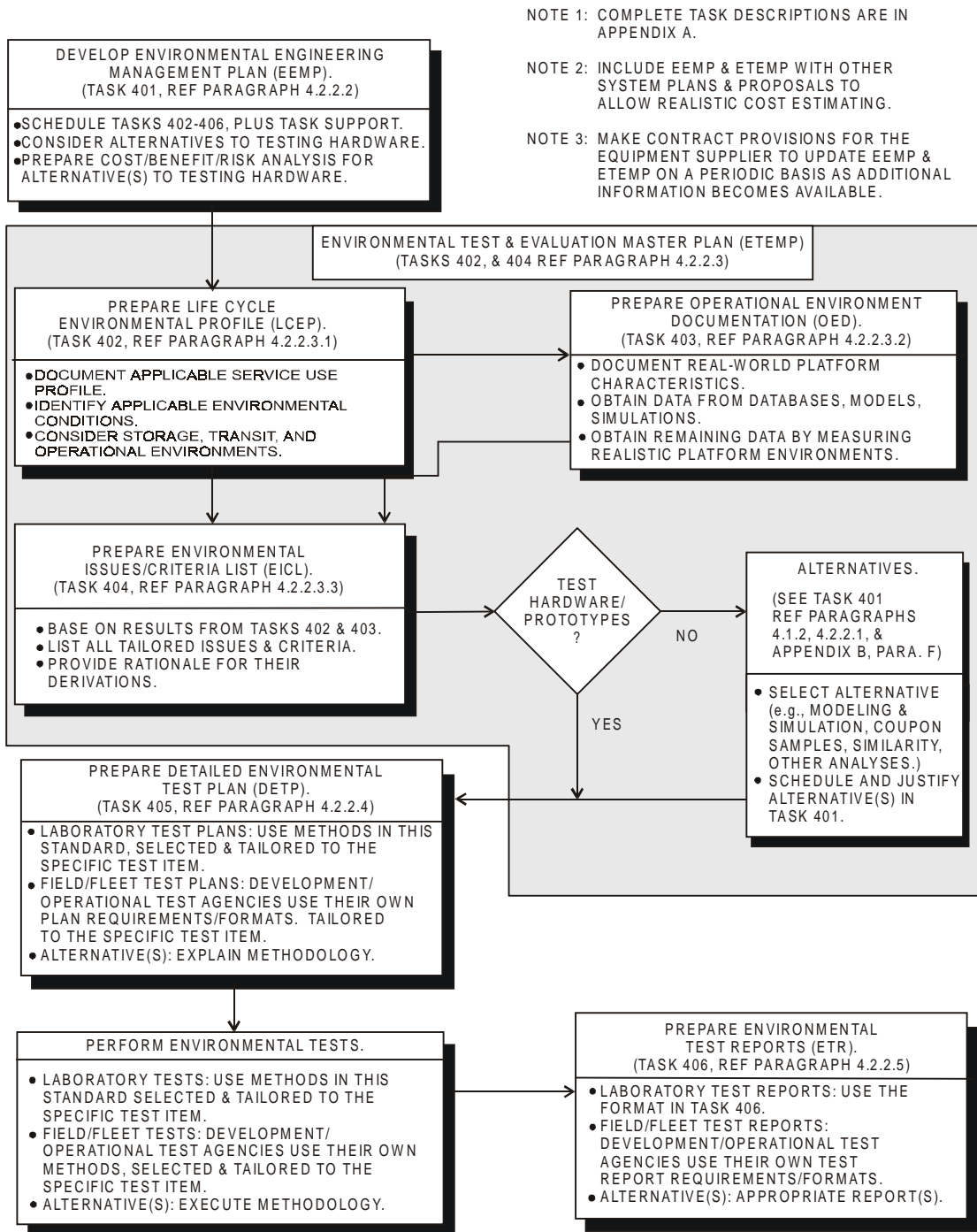

FIGURE 1-1. Environmental engineering program guide.

PART ONE -- ENVIRONMENTAL ENGINEERING PROGRAM GUIDELINES

1. SCOPE.

1.1 Purpose.

- a. This standard contains materiel acquisition program planning and engineering direction for considering the influences that environmental stresses have on materiel throughout all phases of its service life. It is important to note that this document does not impose design or test specifications. Rather, it describes the environmental tailoring process that results in realistic materiel designs and test methods based on materiel system performance requirements. Figure 1-1 summarizes this direction.
- b. This document supports the functions of three different groups of personnel involved in the materiel acquisition process. Each of these groups is critical to the goal of successfully incorporating environmental considerations into materiel design, test, and evaluation. Although each group has different tasks to perform, none of these tasks can be isolated from the others in a successful acquisition program. As shown on figure 1-2, this information is intended for the following:
 - (1) Materiel acquisition program managers among whose responsibilities is ensuring materiel will function as required in intended operational environments. (See paragraph 4.1 below.)
 - (2) Environmental engineering specialists (EES) who assist combat and materiel developers throughout the acquisition process to tailor their materiel designs and test designs to environmental stresses/constraints expected during the materiel's service life. (See paragraph 4.2 below.)
 - (3) Design, test, and evaluation community analysts, engineers, and facility operators who meet user needs by focusing on tailored designs and tests. (See paragraph 4.3 below, and Part Two of this standard.)

1.2 Application.

The tailoring process described in this standard (i.e., systematically considering detrimental effects that various environmental factors may have on a specific materiel system throughout its service life) applies throughout the materiel acquisition cycle to all materiel developed for military or commercial applications, including foreign and nondevelopment item (NDI) procurements.

- a. Part One lays out a disciplined, tailored approach for acquiring systems that will withstand the stresses of climatic, shock and vibration environments that they expect to see in their service lives. The basic process for acquiring materiel that satisfies users' needs from this environmental engineering viewpoint is at figure 1-1.
- b. Part Two also is an integral part of the environmental tailoring process. It contains tailoring information, environmental stress data, and laboratory test methods. The environmental data contained in the methods may help, but should not be used exclusively, to define environmental stresses that materiel will encounter throughout its service life. This will help engineers to tailor analyses and tests to specific materiel and its defined life cycle. It is not valid to call out all of the methods in this standard in a blanket fashion for a materiel system; nor is it valid, once a method is determined appropriate, to regard the environmental stress data, test criteria, and procedures in the method as unalterable.
- c. Guidance and test methods of this standard are intended to:
 - (1) Define environmental stress sequences, durations, and levels of materiel life cycles.
 - (2) Be used to develop analysis and test criteria tailored to the materiel and its environmental life cycle.
 - (3) Evaluate materiel performance when exposed to a life cycle of environmental stresses.
 - (4) Identify deficiencies, shortcomings, and defects in materiel design, materials, manufacturing processes, packaging techniques, and maintenance methods.

MIL-STD-810F
1 January 2000

(5) Demonstrate compliance with contractual requirements.

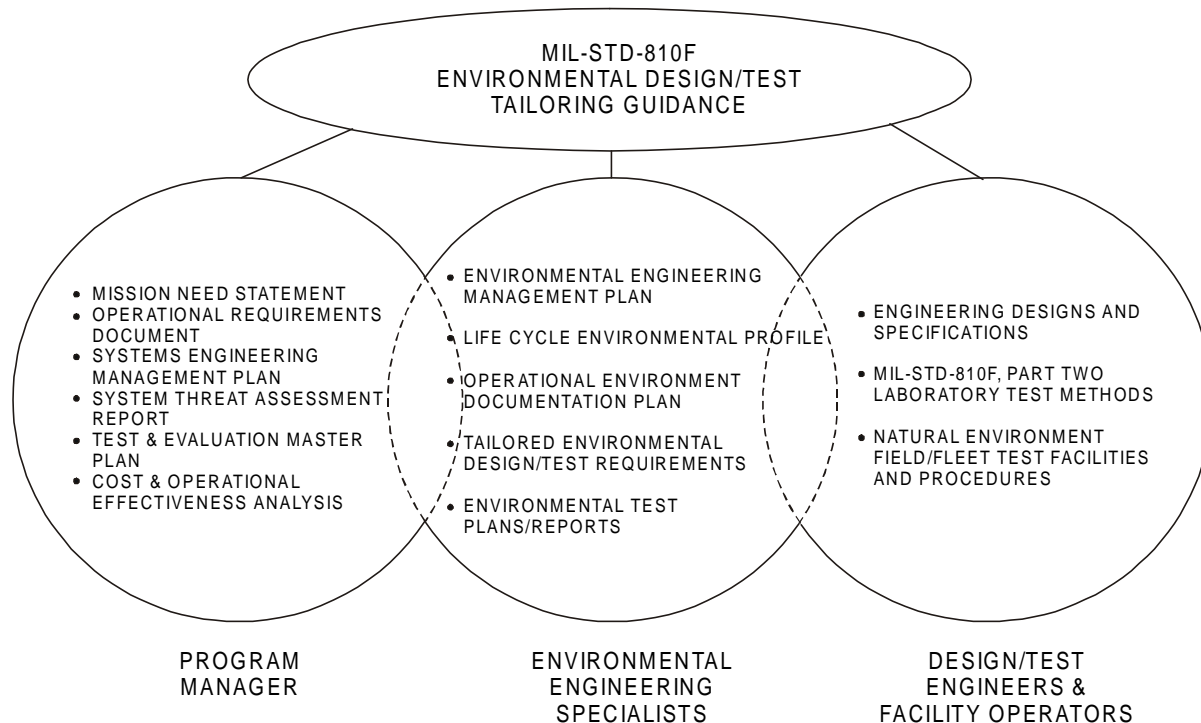

FIGURE 1-2. Roles of acquisition personnel in environmental design/test tailoring process.

1.3 Limitations.

Although environmental analysis, design analysis, and laboratory testing are valuable tools in the materiel acquisition process, there are inherent limitations in analysis and laboratory testing techniques that must be recognized. The methods in Part Two of this standard do not include many of the naturally-occurring forcing functions that may affect materiel performance or integrity in service use. Further, analytic and laboratory test methods are limited in their abilities to simulate synergistic or antagonistic stress combinations, dynamic (time sequence) stress applications, aging, and other potentially significant stress combinations present in natural field/fleet service environments. Use caution when defining and extrapolating analyses, test criteria, and results. Part Two test methods purposely do not address the following but may, in some cases, be applied:

- a. Electromagnetic interference (EMI).
- b. Lightning and magnetic effects.
- c. Nuclear, biological, chemical weapons or their effects.
- d. Certain aspects of munitions and pyrotechnics safety testing.
- e. Piece parts such as bolts, wires, transistors and integrated circuits.
- f. Packaging performance or design.
- g. Suitability of clothing or fabric items that are described in specific specifications.
- h. Environmental stress screening (ESS) methods and procedures.
- i. Reliability testing.
- j. Safety testing.

2. APPLICABLE DOCUMENTS.**2.1 General.**

The documents listed in this paragraph are referenced in Part TWO of this standard. There are other documents cited in Part TWO of this standard that are recommended for additional information or as examples. While every effort has been made to ensure the completeness of this list, document users are cautioned that they should consider all specified requirements documents and tasks cited in paragraph 4 of this standard.

2.2 Government Documents.**2.2.1 Standards.**

The following standard forms a part of this document to the extent specified herein. When applying a portion of this standard that contains one of these references, cite the particular edition of the document that is listed in the current Department of Defense Index of Specifications and Standards (DoDISS), or in the DoDISS that was in effect at the time of solicitation. Unless otherwise specified, the issues of these documents are those listed in the issue of the DoDISS and supplement thereto, cited in the solicitation (see paragraph 6.2).

STANDARD

MIL-STD-882 System Safety Program Requirements

HANDBOOKS

MIL-HDBK-310 Global Climatic Data for Developing Military Products

(Copies of the above documents are available from the Defense Automated Printing Service, Building 4/Section D, 700 Robbins Avenue, Philadelphia PA 19111-5098.)

2.2.2 Other government documents.

The following other Government documents and publications form a part of this document to the extent specified herein. Unless otherwise specified, the issues are those cited in the solicitation.

DIRECTIVES, INSTRUCTIONS, AND MANUALS.

DODD 5000.1 Defense Acquisition

DODD 5000.2 Mandatory Procedures for Major Defense Acquisition Programs (MDAP's) and Major Automated Information System (MAIS) Acquisition Programs

DOD 5000.2M Defense Acquisition Management Documentation and Reports

(Copies of the above documents may be downloaded from the Washington HQ Services web site "<http://web7.whs.osd.mil/corres.htm>".)

PUBLICATIONS

AR 70-38 Research, Development, Test and Evaluation of Materiel for Extreme Climatic Conditions

(Copies of the above document are available from the U.S. Army Publications Distribution Center, 1655 Woodson Rd., St Louis, MO 65104.)

2.3 Non-government Documents.

The following documents form a part of this document to the extent specified herein. Unless otherwise specified, the issues of the documents that are DoD adopted are those listed in the issue of the DoDISS cited in the solicitation. Unless otherwise specified, the issues of documents not listed in the DoDISS are the issues of the documents cited in the solicitation (see 6.2).

MIL-STD-810F
1 January 2000

| | |
|-------------|---|
| STANAG 2895 | Extreme Climatic Conditions and Derived Conditions for Use in Defining Design Test Criteria for NATO Forces Materiel |
| STANAG 4242 | Vibration Tests for Munitions Carried in Tracked Vehicles |
| STANAG 4370 | Environmental Testing |
| QSTAG 360 | Climatic Environmental Conditions Affecting the Design of Military Materiel |
| AECTP 100 | Allied Environmental Conditions and Test Publication (AECTP) 100, Environmental Guidelines for Defence Materiel (under STANAG 4370) |
| AECTP 200 | Allied Environmental Conditions and Test Publication (AECTP) 200, Environmental Conditions (under STANAG 4370) |
| AECTP 300 | Allied Environmental Conditions and Test Publication (AECTP) 300, Climatic Environmental Tests (under STANAG 4370) |
| AECTP 400 | Allied Environmental Conditions and Test Publication (AECTP) 400, Mechanical Environmental Tests (under STANAG 4370) |

(Copies of the above documents are available from the Defense Automated Printing Service, Building 4 / Section D, 700 Robbins Avenue, Philadelphia PA 19111-5098.)

AMERICAN NATIONAL STANDARDS INSTITUTE (ANSI)

ANSI NCSL Z540-1 General Requirements for Calibration Laboratories and Measuring and Test Equipment

INTERNATIONAL ORGANIZATION FOR STANDARDIZATION (ISO) STANDARDS

ISO 10012-1 Quality Assurance Requirements for Measuring Equipment - Part I: Meteorological Confirmation System for Measuring Equipment First Edition

(Copies of the above documents are available from American National Standards Institute (ANSI), 11 West 42nd Street, New York NY 10036-8002.)

2.4 Order of Precedence.

In the event of a conflict between the text of this document and the references cited herein, the text of this document takes precedence. Nothing in this document, however, supersedes applicable laws and regulations unless a specific exemption has been obtained.

3. TERMINOLOGY.

This terminology section is meant to define the general terminology as it is used in this standard. In certain cases the terminology use may be somewhat different from its use in the general engineering community. No attempt has been made to be complete, therefore limiting the glossary to such terms as are found in the standard and that are important to the application of the standard. Terminology unique to a particular method is defined, as appropriate, in that method.

NOTE: A continuation of this terminology section that contains terminology more closely related to the dynamic (mechanical) test methods such as vibration, shock, gunfire vibration, etc., is in Appendix D.

- a. Accelerated test. A test designed to shorten the controlled environmental test time with respect to the service use time by increasing the frequency of occurrence, amplitude, duration, or any combination of these of environmental stresses that would be expected to occur during service use.
- b. Aggravated test. A test in which one or more conditions are set at a more stressful level than the materiel will encounter during service use.

- c. Ambient environment. The conditions, either outdoor or confined (e.g., temperature and humidity), that characterize the air or other medium that surrounds materiel.
- d. Climatic categories. Specific types of world climates which materiel is designed to withstand during operation, storage, and transit. See Part One, Appendix C, table C-I and figure C-1.
- e. Combat developer. Military specialist concerned with training, doctrine, and materiel needs documentation.
- f. Critical threshold value. The level of an environment forcing function that degrades the capability of materiel significantly or requires degradation prevention measures be taken.
- g. Cumulative effects. The collective consequences of environmental stresses during the life cycle of materiel.
- h. Engineering judgement. Expert opinion based on engineering education and experience, especially in the area in which the judgement is made.
- i. Environmental analysis. Technical activity covering an analytical description of the effects that various environments have on materiel, subsystems, and component effectiveness.
- j. Environmental conditions. (See Forcing function (environment).)
- k. Environmental engineering. The discipline of applying engineering practices to the effects that various environments have on materiel effectiveness.
- l. Environmental engineering specialist (EES). A person or group of people skilled in one or more environmental engineering areas. Areas include, but are not necessarily limited to: natural and induced environments and their effects on materiel; expertise in measuring and analyzing in-service environmental conditions; formulating environmental test criteria; determining when environmental laboratory tests are appropriate/valid substitutes for natural in-service environmental tests; and evaluating the effects of specific environments on materiel. (See paragraph 4.2.)
- m. Environmental test. A structured procedure to help determine the effects of natural or induced environments on materiel.
- n. Environmental worthiness. The capability of materiel, subsystem, or component to perform its full array of intended functions in intended environments.
- o. Equipment. For purposes of this standard, equipment includes the instrumentation, facilities, and support apparatus used to conduct or monitor tests. This does not include the test item itself or the materiel of which the test item is a sample or a part.
- p. Forcing function (environment). A natural or induced physical environmental stress condition on materiel that may affect its ability to function as intended or to withstand transit or storage during its service life. (Also referred to as an environmental condition or an environmental stress.)
- q. Hermetic seal. A permanent, air-tight seal.
- r. Induced environment. An environmental condition that is predominantly man-made or generated by the materiel platform. Also, refers to any condition internal to materiel that results from the combination of natural environmental forcing functions and the physical/chemical characteristics of the materiel itself.
- s. In-service use. The anticipated use of materiel during its intended service use life.
- t. Integrated Product Team (IPT). A group of individuals from different professional disciplines and organizations (government and industry) who work together on a product from concept through production stages. Individuals who cover a discipline may change from stage to stage, but the discipline is covered, and the information pertinent to that discipline is passed to the succeeding team member(s) in that discipline.
- u. Life cycle profile. A time history of events and conditions associated with materiel from its release from manufacturing to its removal from service, including demilitarization. The life cycle should include the

MIL-STD-810F
1 January 2000

- various phases materiel will encounter in its life, such as: packaging, handling, shipping, and storage prior to use; mission profiles while in use; phases between missions such as stand-by or storage, transfer to and from repair sites and alternate locations; and geographical locations of expected deployment.
- v. Materiel. A commodity or set of commodities. A generic class of hardware designed to perform a specific function.
 - w. Materiel developer. An agency or group of individuals involved in designing, testing, or evaluating materiel to meet developer performance requirements.
 - x. Mission profile. That portion of the life cycle profile associated with a specific operational mission.
 - y. Operational worthiness. The capability of materiel, a subsystem, or component to perform its full array of intended functions.
 - z. Parameter. Any quantity that represents a descriptive generalization of a certain characteristic physical property of a system that has a certain value at a particular time.
 - aa. Parameter level. The value of a physical property that documents the degree, extent, or level at which a parameter exists at a given location at a given point in time, or the value to which a variable test control is set (see test level).
 - bb. Platform. Any vehicle, surface, or medium that carries the materiel. For example, an aircraft is the carrying platform for installed avionics items or transported or externally mounted stores. The land is the platform for a ground radar set, for example, and a person for a man-portable radio.
 - cc. Platform environment. The environmental conditions materiel experiences as a result of being attached to or loaded onto a platform. The platform environment is influenced by forcing functions induced or modified by the platform and any platform environmental control systems.
 - dd. Program manager. The (Government) official who is in charge of the acquisition process for the materiel.
 - ee. Service life. Period of time from the release of materiel from the manufacturer through retirement and final disposition.
 - ff. Tailoring. The process of choosing design characteristics/tolerances and test environments, methods, procedures, sequences and conditions, and altering critical design and test values, conditions of failure, etc., to take into account the effects of the particular environmental forcing functions to which materiel normally would be subjected during its life cycle. The tailoring process also includes preparing or reviewing engineering task, planning, test, and evaluation documents to help ensure realistic weather, climate, and other physical environmental conditions are given proper consideration throughout the acquisition cycle.
 - gg. Test item. Specific materiel, a subsystem, or component being tested, including its container and packaging materials, that is representative of the materiel being developed. A representative sample of materiel that is used for test purposes.
 - hh. Test level. The value at which a test condition is set or recorded. (Also, see parameter level.)
 - ii. Test method. The criteria and procedures used to formulate an environmental test. Laboratory test methods are identified by the environment (or combinations of environments) in Part Two of this document.
 - jj. Test plan. A document that may include test procedures and test levels, failure criteria, test schedules, and operational and storage requirements.
 - kk. Test procedure. A sequence of actions that prescribes the exposure of a test item to a particular environmental forcing function or combination of environmental forcing functions, as well as inspections, possible operational checks, etc.

- II. Virtual proving ground. Suite of tools, techniques, and procedures by which the tester will verify, validate, test, and evaluate systems, simulators, and models by exposing them to a synthetic rendition of the ground truth. "Ground truth data" are data collected from real-world tests or experiences.

4. GENERAL PROGRAM GUIDELINES.

4.1 Program Managers.

4.1.1 Roles of the program manager.

In the context of this standard, the program manager's primary role is to ensure environmental engineering considerations are addressed systematically, thoroughly, and effectively at appropriate times throughout the materiel acquisition process. The process for accomplishing this integration is diagrammed on figure 1-1. An associated role is to ensure environmental effects information is documented, available, and communicated from one program phase to another.

4.1.2 Guidance for program managers.

- a. DoD 5000-series documents call for a systems engineering process that considers all life cycle needs, including storage, transport, and operation in natural environments, considering for example climatic, terrain, and oceanographic factors (DoDD 5000.2-R, paragraph 4.3). The environmental tailoring process shown on figure 4-1 occurs throughout the materiel acquisition cycle, helping to ensure system design and test criteria are tailored to environmental conditions within which materiel is to operate.
- b. As indicated on figure 1-1, there may be times that the program manager has valid alternatives to testing actual hardware or hardware prototypes when conducting laboratory, development, or operational tests. These alternatives include, but are not necessarily limited to, using simulation to reduce the costs involved in producing and testing hardware prototypes, using coupon samples instead of entire systems when specific materials are the central acquisition issue, and using analytical procedures such as verification by similarity to systems already tested and approved. An environmental engineering specialist (EES) can aid program managers to establish an engineering basis for selecting such alternatives. When these alternatives are selected, Task 401, Environmental Engineering Management Plan, must contain the rationale for their selection, including an explanation of expected cost savings, other benefits and risks to system effectiveness/safety. (See Part One, Appendix A, Task 401, and Appendix B, paragraph F.)
- c. The following paragraphs, organized by major acquisition documents, capsulize environmental effects information for program managers and serve as background information for design engineers, test engineers, and environmental engineering specialists. Appendix B provides detailed direction for program managers.

MIL-STD-810F
1 January 2000

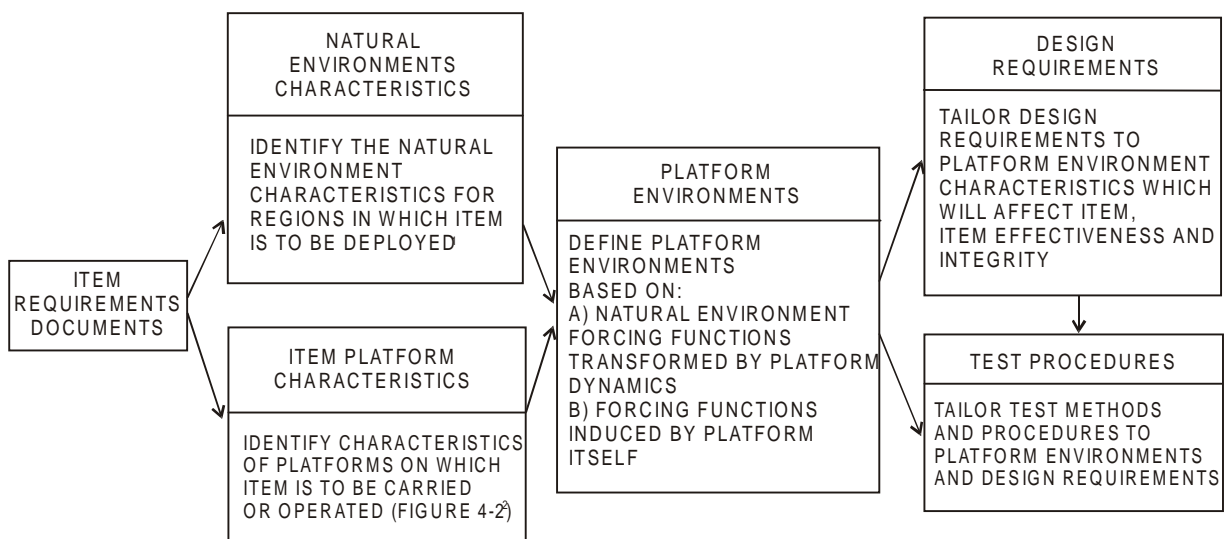

1. CONVENTIONAL METEOROLOGICAL DATA ARE NOT COLLECTED WITH MILITARY HARDWARE IN MIND. GREAT CARE MUST BE TAKEN TO ENSURE THAT THE METEOROLOGICAL DATA USED ARE RELEVANT TO THE SPECIFIC MATERIEL BEING TESTED.

2. IN THIS CONTEXT, A PLATFORM IS ANY VEHICLE, SURFACE, OR MEDIUM THAT CARRIES THE MATERIEL. FOR EXAMPLE, AN AIRCRAFT IS THE CARRYING PLATFORM FOR AN AVIONICS POD, THE LAND ITSELF FOR A GROUND RADAR, AND A MAN FOR A MAN-PORTABLE RADIO.

FIGURE 4-1. Environmental test program tailoring process.

4.1.2.1 Mission Need Statement (MNS).

The MNS identifies environments that may constrain the operation or survivability of materiel, including natural, induced (e.g., temperature and vibration during transportation), and special operational threat environments (e.g., electronic emissions during battle) in which the mission is to be accomplished. The MNS defines the desired levels of mission capability in these environments. An EES can assist the program manager in formulating this environmental effects input to the MNS.

4.1.2.2 Operational Requirements Document (ORD).

The ORD identifies materiel performance parameters that will meet the need described in the MNS. In identifying required capabilities and critical system characteristics, the ORD describes mission, storage, handling, and transport scenarios that the materiel will experience throughout its service life as shown on figure 4-2. In so doing, broad performance requirements (e.g., design for worldwide deployment) that may conflict with tailored issues can be avoided. This input to the ORD, covering natural and man-made environments and expected mission capabilities in those environments, is derived from the fundamental aspects of a Life Cycle Environmental Profile (LCEP). The LCEP, prepared through the assistance of an EES as described in Task 402 in Appendix A, supports development of not only the ORD, but also the Test and Evaluation Master Plan (TEMP) and the Cost and Operational Effectiveness Analysis (COEA) as described below, and the System Threat Analysis Report (STAR).

4.1.2.3 Systems Engineering Management Plan (SEMP).

Program managers integrate environmental technical considerations (effects of various environments on system performance and reliability) into the SEMP. The mechanism for accomplishing this integration is provided in Task 401 in the form of an Environmental Engineering Management Plan (EEMP) prepared through the assistance of an EES. The EEMP basically lays out a schedule for implementing the remaining environmental engineering tasks, Tasks 402 through 406.

4.1.2.4 Test and Evaluation Master Plan (TEMP).

The TEMP includes plans for testing in natural (field/fleet) environments, simulated (laboratory) environments and virtual proving ground (synthetic) environments. An EES assists the program manager in preparing the TEMP by developing an Environmental Test and Evaluation Master Plan (ETEMP), the preparation of which may be merged into the Integrated Test Program Schedule. Appendix C provides information on the balance of field/fleet tests, laboratory tests, and modeling/simulation, and on the values chosen as design criteria or test criteria. Part Two of this standard provides details for developing laboratory test procedures. Component parts of the ETEMP are Tasks 402 through 404. Thus, the ETEMP contains the following:

- a. Life Cycle Environmental Profile (LCEP) displaying the series of events, and environmental conditions derived from those events that materiel is expected to experience from manufacturing release to the end of its useful life. Include in TEMP the system description. (See Task 402.)
- b. Operational Environment Documentation Plan (OEDP) outlining plans for obtaining specific natural or platform environment data to be used in developing tailored environmental test criteria. The OEDP does not have to be included in the TEMP, but is a necessary subtask within the ETEMP for creating a valid basis for environmental test criteria. (See Task 403.)
- c. Environmental Issues and Criteria List (EICL) containing fundamental environmental design and test criteria derived from the tailoring process. Include criteria in the required technical and operational characteristics of the TEMP. Include related critical issues in the TT&E or OT&E outline of the TEMP. (See Task 404.)

4.1.2.5 Cost and Operational Effectiveness Analysis (COEA).

Operational environmental evaluations are integral parts of COEA's. Natural and threat environmental factors are critical in evaluating how well materiel will operate in regions where it is expected to be employed. Therefore, it is important to identify appropriate values for materiel design and test criteria related to environmental factors. An EES supports COEA preparation by preparing an LCEP and identifying realistic environmental parameters and materiel-specific parameter levels associated with environment-related issues and criteria.

4.2 Environmental Engineering Specialists (EES).

EES are government or industry professionals in the acquisition process whose experience allows them to support program managers by helping to perform the tasks in Appendix A. Their backgrounds may span many scientific/engineering disciplines. They already exist in Government and contractor agencies involved in the acquisition process (e.g., serving as design, test, and reliability engineers/scientists). Several EES of different backgrounds may work on an integrated product team (IPT) at one time or in sequence throughout the program, employed by or on contract to agencies of the services as appropriate at the time. Their work is documented and passed on through the products of each successive task.

4.2.1 Roles of environmental engineering specialists.

EES from agencies within and on contract to government agencies support program managers throughout the acquisition cycle. EES are assigned by agencies that are responsible for performing the tasks outlined on figure 1-1 and explained in detail in Part One, Appendix A. EES should be involved early in the acquisition process, serving as critical sources of environmental effects expertise and as technical facilitators throughout the entire acquisition process as part of an IPT. As shown on figure 1-2, EES form facilitating bridges among design and test needs of program managers and technical procedures used by testers. The primary mechanisms for accomplishing environmental engineering goals are the tailoring tasks described below.

MIL-STD-810F
1 January 2000

4.2.2 Environmental engineering tailoring tasks.

4.2.2.1 General.

- a. Environmental engineering tailoring tasks are the basic strategy and structure for integrating environmental considerations into acquisition programs. The task sequence outlined on figure 1-1 is designed to meet the environmental effects integration called for in the DoD 5000-series documents. To accomplish this integration, EES personnel working for government or contractor staffs throughout the acquisition process help to perform these environmental engineering tasks to help create a scientifically sound, cost effective design and test program in the area of environmental effects. This process, including the hardware test alternatives indicated on figure 1-1, applies to all materiel developed for or intended to be used by the military or industry. Detailed task descriptions are in Appendix A.
- b. As indicated in paragraph 4.1 above, the primary benefits of performing these tasks come from the technical information and structure they provide for the MNS, ORD, SEMP, TEMP, and COEA. This information covers natural and induced environmental conditions. The structure provides an orderly means of uncovering potentially significant environmentally related storage, transit, and operational effects on fielded materiel.

4.2.2.2 Preparing an Environmental Engineering Management Plan (EEMP), Task 401.

The EEMP is the basic management schedule used to integrate environmental effects considerations into the SEMP. This integration helps to ensure materiel will be prepared for all environmental conditions to which it will be subjected during its life cycle. The EEMP identifies manpower, dollar estimates, timing and points of contact necessary to complete the remaining tasks (402 through 406). As indicated on figure 1-1, paragraph 4.1.2 and Appendix B, paragraph F, there may be times that the program manager has valid alternatives, such as modeling and simulation or other analytic techniques, to testing actual materiel or working prototypes. These alternatives are scheduled and justified in the EEMP. The EEMP is described in Part One, Appendix A, Task 401.

4.2.2.3 Developing an Environmental Test and Evaluation Master Plan (ETEMP).

This plan is not a formal document, but is comprised of the products from three separate tasks (Tasks 402, 403, and 404). Early in the acquisition process, initial work on these tasks helps build materiel need and performance requirements documents by identifying basic environments in which the materiel will operate, and fundamental issues to be addressed during the remainder of the acquisition process. These three tasks contribute to the TEMP when they are completed. See figure 1-1. The ETEMP contains basic guidance/background information not to be confused with detailed test planning documents explained in Task 405.

4.2.2.3.1 Defining a Life Cycle Environmental Profile (LCEP), Task 402.

The LCEP describes service-related events and environmental conditions that materiel will experience from its release from manufacturing to the end of its useful life. The scope and structure are shown on figure 4-2. Fundamental progress is required on this task early in the acquisition process to influence the MNS and the ORD. The completed LCEP is needed later in the process to help system designers and evaluators build the TEMP. It is important to note that the LCEP does not specify design or test requirements. Rather, it serves as a tailored guide for deriving materiel designs and test parameters through Tasks 403 and 404, based on performance requirements.

4.2.2.3.2 Developing Operational Environment Documentation (OED), Task 403.

The OED task entails producing two documents. One is a plan for obtaining data that will serve as the basis for design and test criteria development. The other is a report that contains those plans and the resulting data. The plan, the Operational Environment Documentation Plan (OEDP), provides for two types of data. First, it contains plans for securing data that have been collected previously and are still valid for developing the materiel's design and test criteria. Second, it contains plans for collecting data not available currently, describing how to obtain those environmental data under realistic operating or field conditions using actual or closely related systems/platforms.

The OEDP and the resulting data (existing and new data) form the Operational Environment Documentation Report (OEDR).

4.2.2.3.3 Developing an Environmental Issues/Criteria List (EICL), Task 404.

The EICL is developed from the LCEP and OEDR. It contains a list of tailored issues and criteria, complete with appropriate criterion levels for the materiel being acquired. Also, it includes rationale and assumptions for how environmental effects issues and criteria were derived. This rationale aids designers, developers, and assessors as they revise criteria when materiel deployment concepts and designs change.

4.2.2.4 Preparing a Detailed Environmental Test Plan (DETP), Task 405.

Developers, evaluators, assessors, and testers prepare detailed environmental test and evaluation plans in various levels of detail (e.g., Independent Evaluation Plans through Detailed Test Plans), consulting with on-board EES as necessary. These detailed plans serve as the primary means for calling out specific laboratory and field tests, test sites, instrumentation, procedures, and criterion levels for environmental tests. The DETP may stand alone as an environmental test planning document or may appear as a subset of a larger test plan. Quite often, the highest level of detail in these plans appears in standard test procedures referenced in those plans. For environmental laboratory tests, detailed methods are in Part Two of this standard.

4.2.2.5 Preparing an Environmental Test Report (ETR), Task 406.

Environmental test reports are produced at various points in the acquisition process. Specifications for conducting development and operational tests and formats for resulting reports are provided by development and operational test agencies. This task pertains mainly to the results of materiel tests performed in environmental testing laboratories. The ETR defines the test purpose, lists test issues/criteria, lists or describes test equipment/facilities/instrumentation, explains the test design/set-up, contains detailed test data/logs, provides failure analyses, and interprets test results. The laboratory ETR is appropriate for design evaluation tests, operational worthiness tests, and qualification tests. Data from these laboratory tests serve as early warnings of unanticipated deviations from performance requirements. They support failure analyses and corrective actions related to the ability of materiel to withstand specific environmental conditions. These laboratory test data do not serve as substitutes for development or operational tests conducted in natural field/fleet environments.

4.3 Design and Test Engineers and Facility Operators.

4.3.1 Roles of design engineers.

Design engineers conduct engineering analyses that predict responses of materiel to the stresses of the environmental life cycle. These analyses are used to prepare materiel designs that incorporate necessary resistances to environmental stresses, to modify test criteria to account for factors that cannot be fully accounted for in laboratory testing, and to interpret test results during failure analyses and redesign.

4.3.2 Roles of test engineers/facility operators.

Test engineers develop test implementation plans/instructions that are carried out by other engineers or facility operators. Facility operators conduct tests according to direction established in system test planning and assessment documents and specific instructions prepared by test engineers/scientists who base their procedures on the environmental tailoring process. As a result of the tailoring process, laboratory testers will conduct only those tests that are appropriate, using exposure levels that will be neither too high nor too low because they will have been established according to the environments and levels that the materiel would be expected to see throughout its service life. In the same manner, field/fleet testers will conduct tests in those natural environments in which the materiel is expected to operate.

MIL-STD-810F
1 January 2000

4.3.3 Guidance for design and test engineers and test facility operators.

4.3.3.1 Natural environment (field/fleet) testing.

Plan for and conduct natural environmental field/fleet tests, incorporating the principles of environmental tailoring information into established field/fleet procedures and facilities.

4.3.3.2 Laboratory testing.

Plan for and conduct laboratory tests according to the tailoring information above and specific guidelines below in Part One, plus specific guidelines in each method of Part Two of this standard.

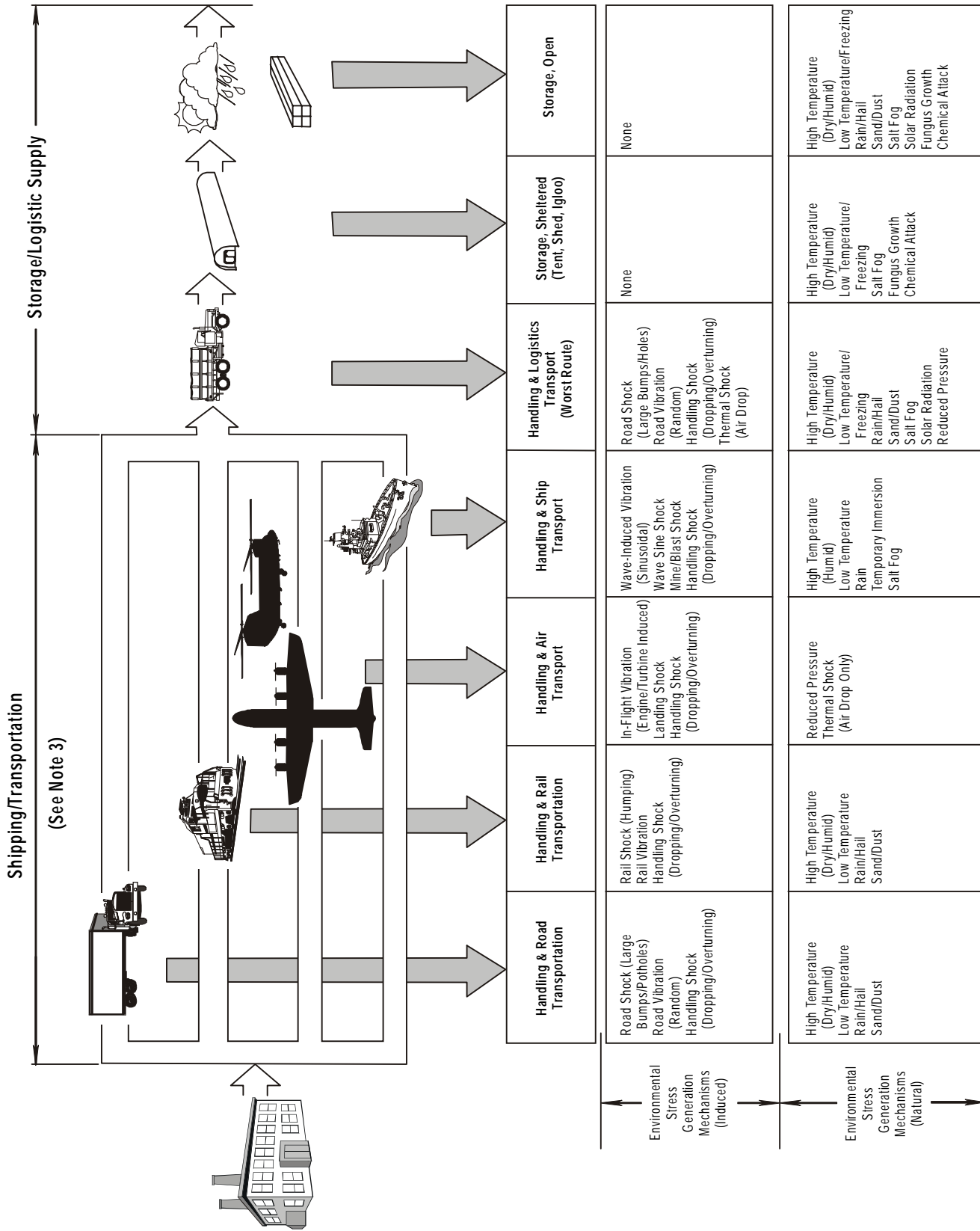

FIGURE 4-2a. Generalized life cycle histories for military hardware.

(See Note 5)

MIL-STD-810F
1 January 2000

Note 1: The environmental stress events experienced by actual hardware may not always occur in the sequence shown in this profile. The generalized profile is intended to be used as a starting point for a tailored life cycle stress analysis and to provide confidence that all potentially significant environmental conditions have been considered.

Note 2: The generalized profile provides only representative decision-making information. It does not impose or imply a specific test order although it can aid in suggesting potentially useful environmental test stress combinations or sequences.

Note 3: Hardware may be subjected to any or all of the shipping/transportation modes shown. Therefore, in any life cycle stress analysis, the anticipated stresses experienced by the hardware in each mode should be evaluated and the most significant of these incorporated in the test program.

Note 4: The generalized profile shows only areas of environmental concern and does not attempt to show operational use patterns. The relative frequency and duration of storage, shipping, and mission events must be considered in determining life cycle environmental test parameters. It should also be remembered that even one-shot devices (rockets, shells, etc.) must endure combinations and repetitions of all these events before they are ultimately fired.

Note 5: In the interest of completeness, some environmental stress generating mechanisms have been included for which corresponding tests are not included in this document. Their absence from this document does not imply a lack of importance; they should be given equal consideration in the life cycle stress analysis.

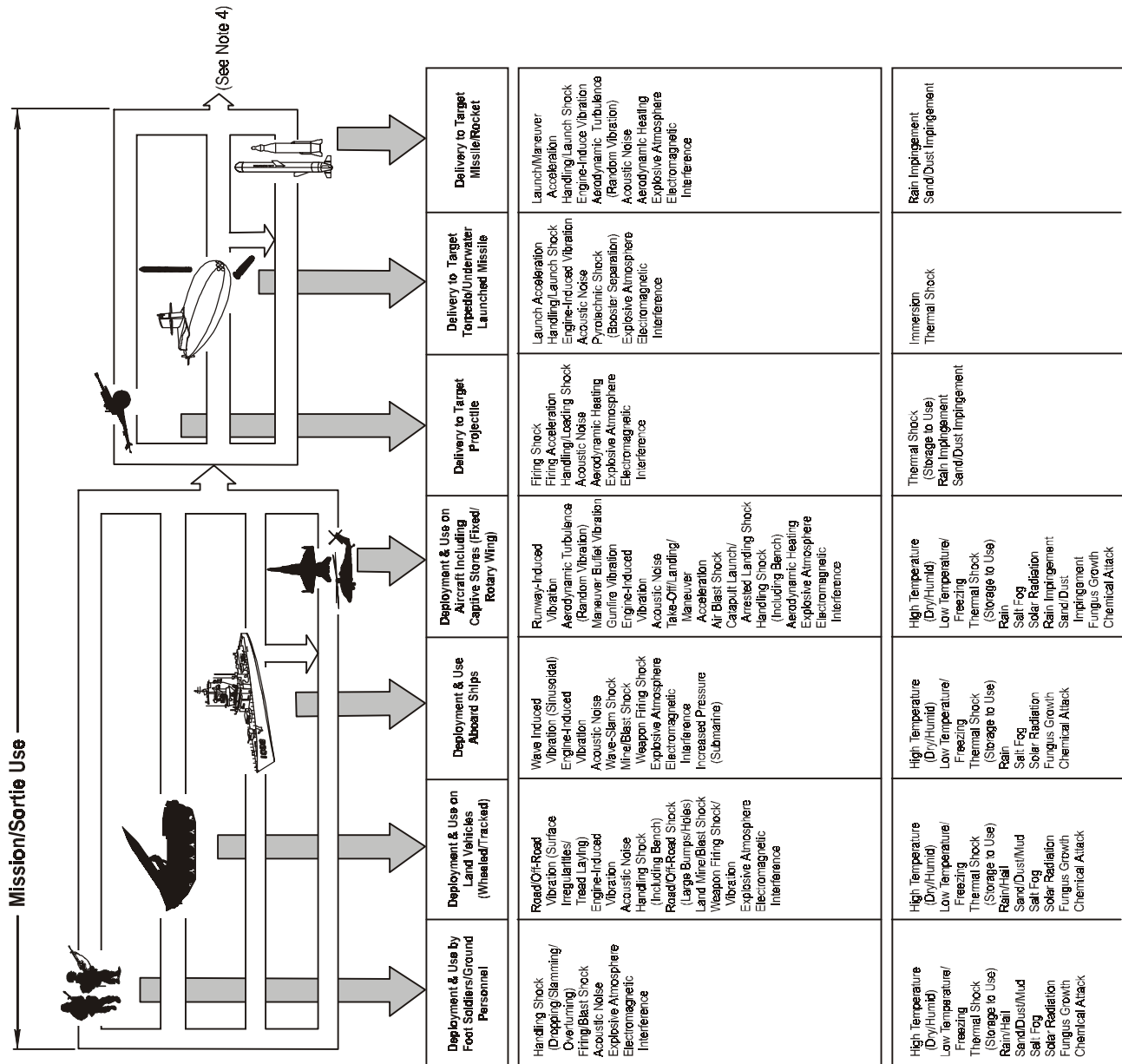

FIGURE 4-2b. Generalized life cycle histories for military hardware.

5. GENERAL LABORATORY TEST METHOD GUIDELINES.

NOTE: Safety is an inherent concern in all test programs. Specific concerns are addressed in appropriate test methods. Guidelines for establishing a materiel safety program are in MIL-STD-882.

5.1 Standard Ambient Test Conditions.

When the term "standard ambient" is specified in the methods of this standard, use the values shown below. If the term is not used and no specific values are called for in the test method or the materiel specification, conduct item tests (e.g., pre-, during, and post-test) at standard ambient conditions.

| | |
|-----------------------|---------------------------|
| Temperature: | 25°C ± 10°C (77°F ± 18°F) |
| Relative humidity: | 20 to 80% |
| Atmospheric pressure: | Site pressure |

NOTE: Every effort has been made to use metric units throughout this document. The initial figures are followed by U.S. units in parentheses, but these conversions are not usually repeated throughout this document.

5.2 Tolerances for Test Conditions.

Unless otherwise specified, adhere to the test condition tolerances shown below for the following parameters. Any tolerance shown as ±X following a specified value is intended to mean the specified value is what is intended but, because of instrumentation or measurement inaccuracies, a slight deviation is acceptable but not outside of the tolerance.

- a. Test section air temperature. Surround the test item totally by an envelope of air (except at necessary support points), considering boundary effects. Keep the air temperature uniform in the immediate vicinity of the item. To ensure that the test item is bathed in the required air temperature, place verification sensors at representative points around the entire item and as close to the test item as possible but not so the airstream temperature is affected by the test item temperature. Keep these temperatures within ± 2°C (3.6°F) of the required test temperature. Ensure the air temperature gradient across the item does not exceed 1°C (2°F) per meter or a maximum of 2.2°C (4°F) total (test item nonoperating). Wider temperature tolerances are acceptable in situations such as:
 - (1) For large items with a volume greater than 5 m³, the temperature tolerance can be ± 3°C. Justify any larger tolerance and obtain approval for its use from the procuring activity.
 - (6) For required temperatures greater than 100°C, the temperature tolerance can be ± 5°C. Specify the actual tolerance achieved.
- b. Pressure. ±5 percent of the value or ±200 Pa, whichever is greater.
- c. Humidity. Keep relative humidity at the chamber control sensor to ±5 percent RH of the specified value.
- d. Vibration amplitude.

| | |
|------------|------------------|
| Sinusoidal | ±10 percent |
| Random | See method 514.5 |
- e. Vibration frequency. Measure vibration frequency of 25 Hz and above to an accuracy of ±2 percent. Below 25 Hz, use ±½ Hz.
- f. Acceleration. Measure acceleration (g's) within 10 percent of the specified value.
- g. Time. Control time (e.g., test durations and data gathering intervals) within 5 minutes for total test durations greater than 8 hours, and within 1 percent of the specified value for durations or intervals of 8 hours or less, unless the nature of the test requires greater accuracy.

MIL-STD-810F
1 January 2000

- h. Air velocity. Maintain within 10 percent of specified value.
- i. Water purity. See paragraph 5.16.

5.3 Test Instrumentation.

5.3.1 Suitability for environment.

Ensure the sensors and instrumentation to be used for recording environmental conditions and responses are suitable for the intended environments. (For example, accelerometers used in a combined high temperature/vibration test could give erroneous readings if not designed for high temperature use.)

5.3.2 Calibration.

Prior to and following each test, verify the accuracy of instruments and test equipment used to control or monitor the test parameters. Calibration intervals must meet the guidelines of ANSI NCSL Z540-1 or ISO 10012-1 to the satisfaction of the procuring activity. All instruments and test equipment used in conducting the tests in this document should:

- a. Be calibrated to laboratory standards, traceable to the National Standards via primary standards.
- b. Have an accuracy at least equal to 1/3 the tolerance of the variable to be measured. In the event of conflict between this accuracy and guidelines for accuracy in any one of the test methods of this standard, the latter governs.

5.4 Stabilizing Test Temperature.

Temperature stabilization is generally important to ensure reproducible test conditions. Stabilizing test item elements critical for operational requirement (i.e., components, subassemblies, etc.) normally is more important than stabilizing temperatures of structural members. The following information is based on this intent.

5.4.1 Test item operating.

Unless otherwise specified, operating temperature stabilization is attained when the temperature of the functioning part(s) of the test item considered to have the longest thermal lag is changing at a rate of no more than 2.0°C (3.6°F) per hour.

5.4.2 Test item non-operating.

Unless otherwise specified, non-operating temperature stabilization is attained when the temperature of the functional part(s) of the test item considered to have the longest thermal lag reaches a temperature that is within the temperature tolerance of the air surrounding the test item. Structural or passive members are not normally considered for stabilization purposes. When adjusting temperatures, the temperature of the chamber air may be adjusted beyond the test condition limits to reduce stabilization time, provided the extended temperature does not induce a response temperature beyond the test item's temperature limits.

5.5 Test Sequence.

Base the specific sequence on the item, its intended situation-dependent use, available program assets, and anticipated synergetic effects of the individual test environments. In defining a life cycle sequence of exposures, consider recurring exposure(s) that might reasonably occur during service use. In most cases there is no single defined sequence. See Appendix C of Part One for additional information.

- a. Use the anticipated life cycle sequence of events as a general sequence guide. However, experience has shown definite advantages to performing certain tests immediately before, in combination with, or immediately following other tests. Where these advantages have been identified in the information in the test methods, follow the test sequence. Use other sequences and combinations consistent with good

tailoring practices with the permission of the acquisition agency. With the exception of information provided in the individual methods, do not alter test sequences to ease the effects of the tests.

- b. Relate cumulative effects on performance and durability of a materiel item to a test sequence that stresses materiel in the proper order according to its mission profile (see Part One, figure 4-2 as an example). Developing such a test sequence requires communication among the test sponsor, the tester, the evaluator, and the end user early and often to ensure a trackable, reliable, and realistic test effort.

5.6 Test Level Derivation.

Derive specific test levels, ranges, rates, and durations from data that occur on identical or appropriately similar materiel that is situated on platforms under similar natural environmental conditions (see Appendix A, Task 403, paragraph 403.2.1). When data from actual situations are not available or cannot be obtained nor estimated easily, tailor the test characteristics using the information found in specific methods.

5.7 Pretest Information for Facility Operators.

Provide the following (in addition to any information required in the individual test methods):

- a. Test facilities and instrumentation.
- b. Required test procedure(s).
- c. Critical components, if applicable.
- d. Test duration.
- e. Test item configuration.
- f. Test level, duration, and method of stress application.
- g. Location of instrumentation/sensors, e.g., thermocouples, transducers.
- h. Test item installation details (including mounting provisions, orientation, interconnections, etc.).
- i. Cooling provisions, if appropriate.

5.8 Test Setup.

5.8.1 Installing the test item in test facility.

Unless otherwise specified, install the test item in the test facility in a manner that will simulate service use to the maximum extent practical, with test connections made and instrumentation attached as necessary.

- a. To test the effectiveness of protective devices, ensure plugs, covers, and inspection plates used in servicing are in whatever position is appropriate for the test and in their normal (protected or unprotected) mode during operation.
- b. Make electrical and mechanical connections normally used in service, but not required for the test being performed (e.g., tests of items not running) with dummy connectors installed (connected and protected as in field/fleet use) so that all portions of the test item will receive a realistic test.
- c. If the item to be tested consists of several separate units, these units may be tested separately, provided the functional aspects are maintained as defined in the requirement's document. If units are being tested together and the mechanical, electrical, and RF interfaces permit, position units at least 15 cm (6 inches) from each other or from the test chamber surfaces to allow for realistic air circulation.
- d. Protect test items from unrelated environmental contaminants.

5.8.2 Test item operation.

Operate the test item in the most representative operating modes (from performance and thermal standpoints) using duty cycles and durations that represent service use.

MIL-STD-810F
1 January 2000

5.9 Pretest Baseline Data.

Before environmental exposure, operate the test item under standard ambient conditions (see paragraph 5.1) to ensure the test item is operating properly and to obtain baseline performance data. Include the following information in the pretest documentation:

- a. Background data of each item:
 - (1) Item nomenclature, model, serial number, manufacturer, etc.
 - (2) General appearance/condition.
 - (3) Specific physical anomalies.
 - (4) Environmental test history of the specific item.
- b. Collect pretest data on the functional parameters that will be monitored during and after each environmental test. Use functional parameters and operational limits specified in the materiel specification or requirements document. If such specifications are not provided, establish and apply appropriate parameters/limits for the pretest, the main test, and the post test.

5.10 Information During Test.

- a. Performance check. When there is a reason to operate the test item during the exposure, perform suitable tests/analyses to determine if the test exposure produces changes in performance when compared with pretest data.
- b. Test facility. Maintain a record of environmental conditions applied to the test item.
- c. Test item response. Maintain a record of test item response to applied environmental forcing functions.

5.11 Interrupted Tests.

For the purpose of standardization and valid testing, and unless otherwise specified in the individual methods, apply the following procedures when a test is interrupted. Explain test interruptions in the test report, and any deviation from the following information.

5.11.1 In-tolerance interruptions.

Interruption periods during which the prescribed test conditions remain in tolerance (e.g., power interruptions that do not affect chamber temperature) do not constitute a test interruption. Therefore, do not modify the test duration if exposure to proper test levels was maintained during the ancillary interruption.

5.11.2 Out-of-tolerance interruptions for methods 503, 506, 510, 511, 514, 515, 516, 517, 519, 522, and 523.

A logic diagram for these methods is on figure 5-1.

- a. Undertest. If test condition tolerances fall below the minimum tolerance value (i.e., environmental stress less severe than specified) resulting in an undertest condition, the test may be resumed (after reestablishing prescribed conditions, except as noted in the individual methods) from the point at which the test condition fell below the lower tolerance level. Extend the test to achieve the prescribed test cycle duration.
- b. Overtest. If an overtest condition occurs, the preferable course of action is to stop the test and start over with a new test item. But, as shown on figure 5-1, if there is no damage to the test item, continue the test, realizing that if the item fails the test from this point on or fails subsequent tests, you have a "NO TEST" unless it can be shown that the overtest condition had no effect on the test item. Overtest conditions can damage the test item and cause subsequent failures that may not have occurred otherwise, thus failing a test item because of an invalid test. However, if damage resulting directly from an overtest occurs to a test item component that has absolutely no impact on the data being collected, and it is known that such damage is the only damage caused by the overtest (e.g., rubber feet on bottom of a test item melted by high temperature where those feet have no impact on the performance of the test item), the test item can

be repaired and the test resumed and extended as in the undertest condition. Coordinate with the customer before repairing and continuing to test an item after it has been overtested. This coordination is aimed at preventing customer objections if the test item fails during the remainder of the test program (claims that the test was invalid past the point of the overtest because the overtest caused undiscovered damage to a critical component).

5.11.3 Out-of-tolerance interruptions for methods 500, 501, 502, 504, 505, 507, 508, 509, 512, 513, 518, 520, and 521.

Each of these methods contains information for handling out-of-tolerance test of interruptions. Analyze any such interruption carefully. If the decision is made to continue testing from the point of interruption, to restart the last successfully completed test cycle, or to restart the entire test with the same test item, and a failure occurs, it is essential to determine the effects of having interrupted or extended the test.

5.12 Combined Tests.

Combinations of tests may represent the effects of the environment more realistically than a series of single tests. Combined environment testing is encouraged when these conditions may be expected in operational environments.

5.13 Post-test Data.

After completing each environmental test, examine the test item in accordance with the materiel specifications. Operate the test item when appropriate for obtaining post-test data. Compare the results with the pretest data obtained in accordance with paragraphs 5.8 and 5.10. Include the following information in the post test record:

- a. Test item identification (manufacturer, model/serial number, etc.).
- b. Test equipment identification, including accessories.
- c. The actual test sequence (program) used.
- d. Deviation from the planned test program (including explanation).
- e. Performance data collected on the same parameters at the same operational levels as those of the pretest (including visual examination results and photographs, if applicable).
- f. Test item identification (manufacturer, model/serial number, etc.).
- g. Room ambient test conditions recorded periodically during test period.
- h. Other data specified in individual methods or requirements document(s).
- i. Initial failure analyses, if applicable.
- j. A signature and date block for the test engineer/technician to certify the test data.

MIL-STD-810F
1 January 2000

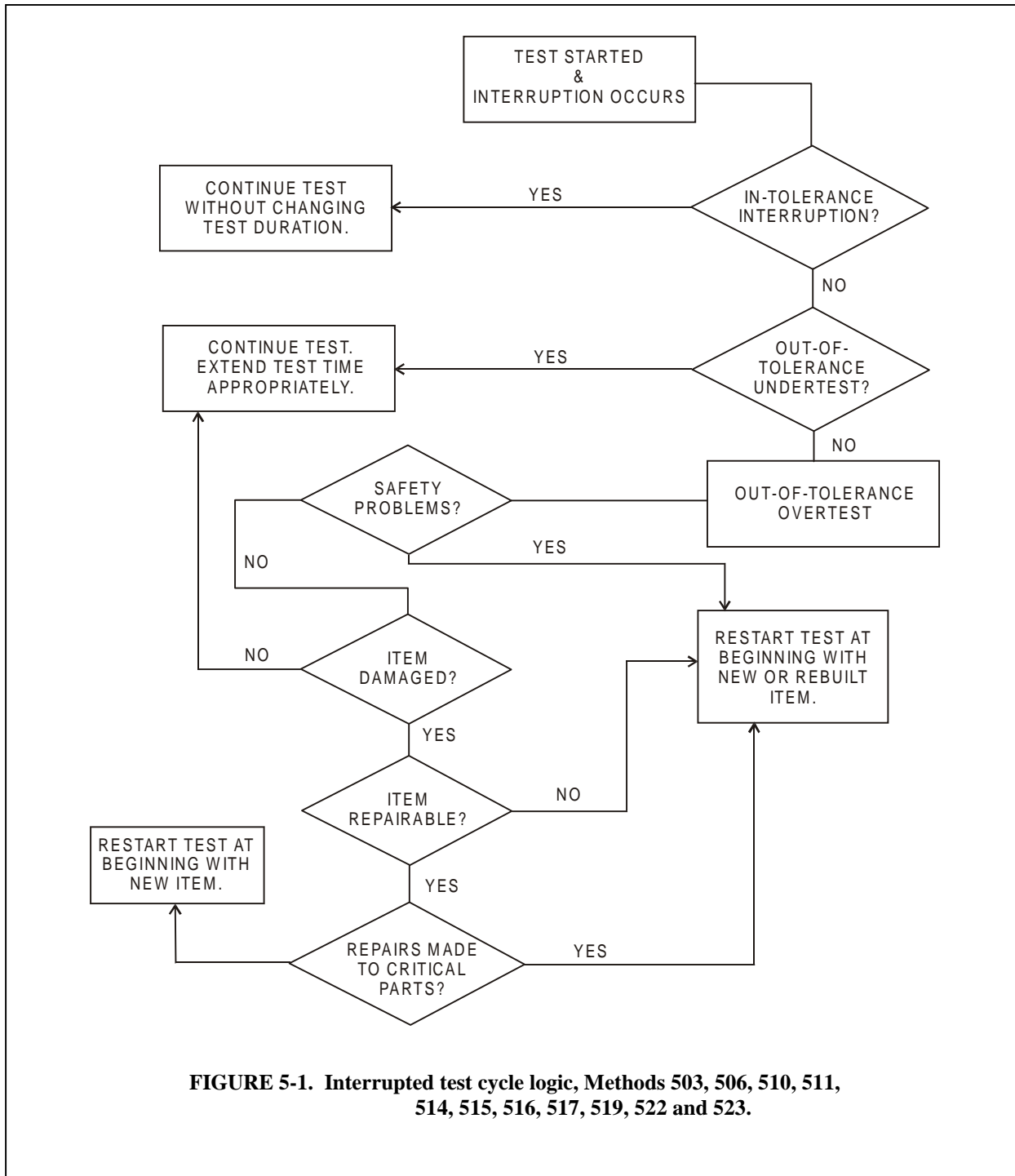

FIGURE 5-1. Interrupted test cycle logic, Methods 503, 506, 510, 511, 514, 515, 516, 517, 519, 522 and 523.

5.14 Environmental Effects and Failure Criteria.

Interpretation of the effects of an environmental test depends on the purpose of the test in the context of a specific acquisition program. Structural degradation and performance anomalies may be considered as useful information during engineering development tests, but as failures during formal tests for contractual compliance. The following are some of the most common conditions that could constitute a materiel failure, depending on specific contract requirements.

- a. Deviation of monitored functional parameter levels beyond acceptable limits established in the pretest performance record and specified in the requirements document. NOTE: Certain types of materiel (e.g., propellants and electrically driven devices) often are expected to demonstrate decreased performance at an environmental extreme, particularly low temperature. A failure would occur only if degradation is more than permissible, or remains degraded after removal of the environmental stress.
- b. Not fulfilling safety requirements or developing safety hazards.
- c. Not fulfilling specific materiel requirements.
- d. Test item changes that could prevent the materiel from meeting its intended service life or maintenance requirements. (For example: Corroded oil drain plug cannot be removed with specified tools.)
- e. Deviation from established environmental impact requirements. (For example: Exhaust emission levels beyond established limits or seal failures that allow oil spills.)
- f. Additional failure criteria as specified in the materiel specification.

5.15 Environmental Test Reports.

Complete environmental test reports according to Part One, Appendix A, Task 406.

5.16 Water Purity.

It is essential that water used for humidity (water vapor and wet bulb socks), salt fog and fungus growth (all aspects) tests not unfairly impose contaminants or unintended products on test items, or affect fungus germination. Chemicals commonly found in commercial water supplies such as chlorine can cause unintended corrosive effects. Solubles such as calcium carbonate (lime) or insolubles can cause nozzles to clog or leave deposits. Water with a non-neutral pH could cause unintended effects on materiel. Accordingly, rather than impose unrealistic water purity requirements on test establishments, recommend water used for these tests be relatively clean of impurities and chemicals, and have a pH in the range of 6.5 to 7.2 at 25°C at the time of the test. NOTE: A water resistivity in the range of 150,000 ohm cm (open tank humidity generators that act as additional distillers, greatly increasing the purity of the water actually arriving at the test item), to 250,000 ohm cm is recommended. This can be produced using distillation, demineralization, reverse osmosis, or deionization.

5.17 Analysis of Results.

- a. The analysis of test results is to be consistent with the guidance provided in paragraph 5.14 above, as well as Part One, Appendix A, Tasks 405 and 406. Additionally, the analysis of results will, in general, consist of presentation in some appropriate format as called out by the DETP, the (1) measured input environment to the test item; (2) the measured response environment of the test item, and (3) the functional or operational performance of the test item under the environmental stress. With regard to (1) and (2), these may include temperature, humidity, pressure, acoustic, acceleration, velocity, displacement, vibration or shock. With regard to (3), this may include the mechanical, electrical, overall functional or safety performance while under environmental stress.
- b. The goal of the “analysis of results” paragraph in each test method is an attempt to correlate the measured response environments and the functional or operational performance of the test item with the measured input environment considering any synergistic effects. Performance of this correlation may

MIL-STD-810F
1 January 2000

require an understanding of an idealized model of the test item, a careful study of the physics of failure, and some rudimentary understanding of the synergistic effects of combined environments. In extended duration environmental tests, an understanding of the general “fatigue” stress receptivity of the test item is required. Underlying all of this is the purpose of the test and the relationship of the test to the goals of the test, i.e., environmental qualification, test-analyze-and-fix, developmental testing, etc. In some cases the test will be designed to simulate the in-service environment. In other cases it will be designed to envelope the environment in hope of providing a conservative margin to a design and, in other cases, the test may be exploratory in nature to examine the “fragility” of the test materiel.

5.18 Monitoring.

5.18.1 Monitoring test chamber parameters.

It is good scientific and engineering practice to monitor chamber conditions to ensure that the chamber settings are correct and that the desired environmental conditions within the chamber are being maintained within specified tolerances throughout the duration of the test. An environmental engineering specialist should work with the customer to tailor monitoring requirements to the customer's needs. Considerations include:

- a. The frequency of monitoring may vary depending on the data requirements and how the data are to be used. Monitor test parameter levels throughout the test at intervals that are meaningful for the item under test such that a failure to maintain prescribed parameter levels may be corrected without jeopardizing the validity of the test.
- b. Establish an alarm system to be triggered by parameter levels that stray out of tolerance beyond acceptable limits.
- c. To provide proof of parameter level maintenance, keep a manually- or electronically-produced log of parameter levels. Exact parameter monitoring intervals and exact methods of recording parameter levels may vary for different methods and for different items being tested using a specific method. In some instances, monitoring chamber parameters may be required only at long intervals (15-minutes or even several hours). In others, continual, non-stop recording may be necessary.
- d. The technology involved in recording parameter levels may involve visual checks at prescribed intervals, real time continuous recording such as a circular chart, periodic recording on a device such as a data logger, or other techniques established in a contract or agreed upon by the tester and the customer.
- e. From a quality assurance standpoint, the intervals at which monitoring should occur depend on how meaningful the interval length is to the customer, who should be provided with monitoring records that are no longer nor shorter in interval than the customer needs.

5.18.2 Monitoring the item under test.

It is equally important to monitor the test item itself to record the effects of the chamber environment on the physical condition or performance of the item under test. The reason for such monitoring is to ensure that pertinent changes in the condition of the item under test are captured at relevant intervals throughout the duration of the test so that meaningful test item failure analyses may be performed. Consider the following:

- a. The tester must meet contractual or other monitoring requirements established by the customer to fulfill test data needs.
- b. The frequency of monitoring will vary depending on the data requirements and how the data are to be used. For example, during conditioning, it may be desirable to monitor the condition of the test item infrequently because the information gathered during this period of testing, though important, may not be highly critical. However, during cycled static testing or system performance testing, the frequency of monitoring the test item may be higher at the beginning of a test to capture initial, fast-occurring

degradation. Other minimum intervals may be set to capture transient events that may occur at any time during the test.

6. NOTES

(This paragraph contains information of a general or explanatory nature that may be helpful.)

6.1 Intended Use.

This standard is intended to organize and standardize the approach within the materiel acquisition process for considering how environmental stresses affect materiel design, test, and evaluation. It emphasizes tailoring materiel to withstand the stresses it is intended to see during its life cycle, and testing such materiel accordingly. The intended result is to eliminate over- and under-designed/tested materiel with respect to environmental stresses; to ensure environmental considerations are addressed systematically; to ensure test plans are tailored realistically as well as thoroughly; to ensure test execution adheres to tailored test plans, and to ensure test reports are complete and meaningful.

6.2 Issue of DoDISS.

When this standard is used in acquisition, the applicable issue of the DoDISS must be cited in the solicitation (see paragraphs 2.2.1 and 2.3).

6.3 Subject Term (key word) Listing. (Also see Subject Index, page 63.)

- Acceleration
- Acoustic Noise
- Climatic Environment
- Dust
- Environmental Engineering
- Environmental Life Cycle
- Environmental Test Procedures
- Environmental Test Report
- Explosive Atmosphere
- Fungus
- Gunfire Vibration
- Humidity
- Induced Environment
- Low Pressure (Altitude)
- Natural Environment
- Rain
- Salt Fog
- Sand
- Shock, Mechanical
- Solar Radiation
- Temperature
- Temperature Shock
- Vibration

6.4 International Standardization Agreement.

Certain provisions of this standard are the subject of international standardization agreements STANAG's 2895 and 4370. When proposed amendments, revisions, or cancellation of this standard will modify the international agreement concerned, the preparing activity will take appropriate action through international standardization channels, including departmental standardization offices, to change the agreement or make other appropriate accommodations.

MIL-STD-810F
1 January 2000

6.5 Changes from Previous Issue.

This document is a complete rewrite of MIL-STD-810E. Due to the extensive modifications, asterisks or vertical lines are not used to identify changes from the previous issue. Changes to MIL-STD-810F will be published in Change Notices.

Custodians:

Army - TE
Navy - AS
Air Force - 11

Preparing activity

Air Force - 11

Project No.

ENVR-0045

Review activities:

Army - AR, AT, AV, CE, CR, GL, HD, MT, SM
Navy - CH, EC, MC, OS, SH, YD
Air Force - 10, 13, 19, 69

International interest (see paragraph 6.4)

APPENDIX A

ENVIRONMENTAL MANAGEMENT AND ENGINEERING TASKS

| <u>Task</u> | <u>Page</u> |
|---|-------------|
| Task 401 - Environmental Engineering Management Plan (EEMP) | A-3 |
| Task 402 - Life Cycle Environmental Profile (LCEP) | A-5 |
| Task 403 - Operational Environment Documentation (OED)..... | A-7 |
| Task 404 - Environmental Issues/Criteria List (EICL)..... | A-9 |
| Task 405 - Detailed Environmental Test Plans (DETP) | A-11 |
| Task 406 - Environmental Test Reports (ETR)..... | A-15 |

MIL-STD-810F
1 January 2000
APPENDIX A

THIS PAGE INTENTIONALLY BLANK

TASK 401**ENVIRONMENTAL ENGINEERING MANAGEMENT PLAN (EEMP)**

401.1 Purpose. The EEMP is basically an administrative document prepared by the program manager's staff or contract personnel responsible to the program manager. It provides a schedule for integrating Tasks 402 through 406 into the Systems Engineering Management Plan (SEMP). By so doing, the EEMP lays out a viable and cost effective environmental effects program to help ensure that materiel will be designed and tested for all pertinent environmental conditions to which it will be subjected during its life cycle. The EEMP also outlines critical environmental engineering technical and communications interfaces between the materiel developer and the procuring agency.

401.2 Task description. As a minimum, perform the following subtasks and include subtask products in the EEMP:

- a. Identify Government agencies and contracts that will include EES personnel to assist in organizing and executing environmental engineering tasks. Include list in EEMP.
- b. Include in the EEMP the environmental engineering tasks listed below. Note that Tasks 402, 403, and 404 comprise the Environmental Test and Evaluation Master Plan (ETEMP) which provides fundamental input to the MNS and ORD and detailed input to the TEMP (see Part One, figure 1-1 and paragraph 4.1.2.4).
 - (1) Task 402 - Life Cycle Environmental Profile (LCEP)
 - (2) Task 403 - Operational Environment Documentation (OED)
 - (3) Task 404 - Environmental Issues/Criteria List (EICL)
 - (4) Task 405 - Detailed Environmental Test Plans (DETP)
 - (5) Task 406 - Environmental Test Report (ETR)
 - (6) Other program-specific tasks as appropriate
- c. Provide risk assessments for any tasks that are eliminated or curtailed, and for alternatives to testing actual hardware or prototypes. For example, if an analytical procedure, acceptance by similarity to another system, coupon samples, or simulations are used in lieu of testing actual systems or prototypes, explain the cost savings, other benefits, and risks to system effectiveness/safety. Because the EEMP is a living document, it may be changed at any time to accommodate such alternatives.
- d. Develop schedules, milestones, and personnel requirements needed to accomplish these tasks.
- e. Identify lines of communication among the specific developer and acquisition agency organizational elements responsible for environmental engineering.
- f. Develop methods/schedules for monitoring, assessing, reporting government and contractor progress on tasks; updating task products (e.g., profiles and plans), and for implementing corrective actions for problems in developing and executing the EEMP, and include them in EEMP.

401.3 Details to be provided by the acquisition agency.

- a. Complete description of the materiel to be developed and the scenarios associated with its intended service application(s).
- b. Schedule and procedures for EEMP submittal.
- c. Identification as a contract task or submittal.
- d. Special conditions or restrictions.

MIL-STD-810F
1 January 2000
APPENDIX A

THIS PAGE INTENTIONALLY BLANK

TASK 402**LIFE CYCLE ENVIRONMENTAL PROFILE (LCEP)**

402.1 Purpose. The LCEP, prepared by an environmental engineering specialist (combat/materiel developer staff or contractor), identifies and characterizes environments or combinations of environments to which the materiel could be exposed throughout its service life. Use the LCEP as the baseline document to support design and test activities throughout the materiel development process.

402.2 Task description. This is one of three tasks (Task 402, 403, and 404) that make up the Environmental Test and Evaluation Master Plan (ETEMP). The LCEP accurately describes real-world environmental conditions that are relevant to the materiel being developed. It provides a consistent baseline for design and test decisions regarding materiel performance and survival under realistically outlined operational environmental conditions. As such, it should not contain conservatism factors, parameter exaggeration, or test procedures that will be covered by other tasks. The LCEP is a living document that should be reviewed and updated periodically as new information regarding operational environmental conditions becomes available.

402.2.1 Contents of LCEP. As a minimum, perform the following subtasks and include subtask products in the LCEP:

- a. Describe the anticipated logistical and operational events associated with the materiel from the time of final factory acceptance until the end of its useful life. Include description in the LCEP.
- b. Develop a list of significant natural and induced environments or combinations of environments associated with each of the events described in "a" above, and include the list in the LCEP.
- c. Prepare narrative, tabular, graphic, and statistical characterizations, to the extent practical, of the environmental stress conditions identified in "b" above. These characterizations may be a combination of analytical calculations, test results, and measurements on materiel systems in service. Include characterizations in LCEP.

402.2.2 Special considerations. When appropriate in developing the LCEP, describe the following special considerations along with any others that may apply, and include the descriptions in the LCEP:

- a. Anticipated materiel configuration(s) during manufacturing, handling, repair/rework, environmental stress screening (ESS), and transport.
- b. Environments to be encountered and their associated geographical and physical locations.
- c. Packaging/container designs/configurations.
- d. Platform on which the materiel is mounted, stored, or transported.
- e. Structural, operating, and other interfaces with adjacent materiel.
- f. Absolute and relative durations of exposure to environmental conditions in each life cycle phase, as well as any other circumstances of occurrence.
- g. Number of times each life cycle phase is expected to occur and its frequency or likelihood of occurrence.
- h. Anticipated limitations and critical values that the environment may have on the materiel because of materiel design or natural laws (e.g., fog or other precipitation may inhibit the effectiveness of infrared sensors).

MIL-STD-810F
1 January 2000
APPENDIX A

402.3 Details to be provided by the acquisition agency. The LCEP must be the product of the shared knowledge of both the materiel supplier and the acquisition agency. The acquisition agency must provide, as a minimum:

- a. A thorough description of all anticipated logistical and operational events associated with the materiel from the time of final factory acceptance until its terminal expenditure, removal from the inventory, and demilitarization. Include:
 - (1) Geographical areas of service or deployment.
 - (2) Platforms on which the materiel will be mounted, stored, or transported.
 - (3) Actual measurements of environmental conditions related to the same or similar materiel and platforms.
- b. Schedule and procedures for LCEP submittal.
- c. Identification as a contract task or submittal.
- d. Special conditions or restrictions.

TASK 403**OPERATIONAL ENVIRONMENT DOCUMENTATION (OED)**

403.1 Purpose. This is one of three tasks (Task 402, 403, and 404) completed by one or more environmental engineering specialists (combat/materiel developer staff or contractor) whose products comprise the Environmental Test and Evaluation Master Plan (ETEMP). To develop the Environmental Issues/Criteria List called for in Task 404, it may be necessary to obtain specific data that describe the environmental conditions laid out in the Life Cycle Environmental Profile established through Task 402. These data, the OED, are produced by preparing a plan and a report: the Operational Environment Documentation Plan (OEDP), to obtain data that will serve as the basis for design and test criteria development; and the Operational Environment Documentation Report (OEDR), that contains the OEDP and the data called for in that plan.

403.2 OEDP subtask description. The Operational Environment Documentation Plan (OEDP) provides for two types of data. First, it contains plans for obtaining data that already exist and are valid for developing the materiel design and test criteria. Second, it contains plans for collecting data not available currently, describing how to obtain those environmental data under realistic operating or field conditions using actual or closely related systems/platforms. As a minimum, perform the following subtasks and include subtask products in the OEDP:

403.2.1 Obtain available field/fleet data. Prepare a list of field/fleet data descriptions of materiel or platform environment conditions that can be used to develop environmental issues and criteria. Include the list in the OEDP. Adhere to all of the following guidelines:

- a. Materiel similarity. Whenever practical, obtain data on the same type of materiel on the same platform type that will carry the materiel to be tested. This ideal situation is often unattainable early in the development of new materiel. Therefore, it is sometimes necessary to derive data from appropriately similar materiel or carrying platforms. Under such circumstances, exact equivalence would not be expected nor required. It is important to note that materiel may be functionally dissimilar but still be considered comparable for documenting environmental stress conditions.
- b. Data quality. Satisfy the following minimum standards before considering field data suitable for use as criterion values in laboratory test procedures. Obtain, analyze, and format field data to be compatible with the specific test procedure for which those data are being considered as criteria. Include the following supporting information:
 - (1) A description of the materiel or the carrying platform.
 - (2) The location on the materiel or carrying platform at which the measurements were made.
 - (3) The ambient environmental and operating conditions under which the measurements were made.
 - (4) The type and calibration status of data recording and analysis equipment and instrumentation.
- c. Data quantity. Sufficient data are needed to adequately describe the conditions being evaluated, but the definition of sufficiency will vary with the environmental conditions, physical and performance characteristics of the hardware type, and program needs. Some engineering judgment may be required to assess the applicability of data when constraints limit the number and location of measurement points. As a minimum, consider:
 - (1) The number and nature of data points.
 - (2) The number and scope of test trials.

MIL-STD-810F
1 January 2000
APPENDIX A

403.2.2 Develop plans for new data. When field/fleet data are not available (in data bases or other data sources) to describe specific environmental conditions, develop plans to acquire these needed data under actual service conditions. Prepare a list of new data requirements that can be used to develop environmental issues and criteria. Prepare plans for obtaining these new data. Include the list and the plans in the OEDP. In addition to following the guidelines and providing the information required in paragraph 403.2.1 above for available data, include the following in the OEDP:

- a. A description of precisely what data are to be collected and to what degrees of accuracy.
- b. A description of the materiel locations at which measurements are to be made.
- c. Identify the instrumentation to be used to make these measurements.
- d. Provide mission profile time histories, durations, and the number of tests for which environmental measurements are to be made.
- e. Describe the assets and personnel to be provided by the procuring activity to obtain the required data, including vehicles, facilities, and information collection and processing equipment.
- f. Provide schedules for acquiring data.
- g. Identify the geographic locations at which measurements are to be made.
- h. Identify points of contact and lines of communication between the procuring activity and the contractor environmental engineering organizations.

403.2.3 Details to be provided by the acquisition agency.

- a. Platforms and personnel availability for acquiring data.
- b. Geographic locations available for data acquisition.
- c. Data acquisition instrumentation and analysis equipment available at test sites.

403.3 Operational Environment Documentation Report. The OEDP, along with the data resulting from its implementation, form the Operational Environment Documentation Report (OEDR).

TASK 404**ENVIRONMENTAL ISSUES/CRITERIA LIST (EICL)**

404.1 Purpose. This task, completed by one or more environmental engineering specialists (combat/materiel developer staff or contractor), provides a list of issues and criteria that cover the effects that various environments have on materiel performance and reliability. It includes design and test criteria and issues, and their supporting rationale and assumptions. This is one of three tasks (Task 402, 403, and 404) that make up the Environmental Test and Evaluation Master Plan (ETEMP). Critical issues and basic criteria may appear in the MNS, ORD, and TEMP. Environmental design and test issues/criteria are derived from the LCEP and OED data.

404.2 Task description. For each environmental stress type or combination of stress types to be considered in materiel design/testing, include the following information, as a minimum, in the EICL. Note that design and test criteria may not be the same in all cases because some form of time compression, stress exaggeration, or other simplifying assumptions may be needed to perform tests, particularly laboratory tests, in a practical schedule with available facilities. However, test criteria must always be tailored realistically.

- a. Develop specific design and test criteria (including specific criterion values) and their associated critical issues. Include these issues and criteria in the EICL.
- b. Develop rationale and assumptions used to select the specific criteria, including the significance of the criteria with respect to materiel performance and durability, and including factors of conservatism. Include these in the EICL.
- c. Explain differences between design and test criteria, including test compression algorithms, fatigue acceleration models, and test facility limitations.
- d. Estimate expected degree of correlation between laboratory test results and anticipated service experiences.

404.3 Details. Details to be provided by the acquisition agency.

- a. Service scenarios of greatest concern for performance and durability.
- b. Data analysis methodologies (optional).
- c. Test time compression algorithms or stress models (optional).

MIL-STD-810F
1 January 2000
APPENDIX A

THIS PAGE INTENTIONALLY BLANK

TASK 405**DETAILED ENVIRONMENTAL TEST PLANS (DETP)**

405.1 Purpose. This task calls for detailed plans for conducting environmental tests required to determine if the environmental criteria developed in Task 404 are met and their associated critical issues are satisfied, and to identify critical environmental threshold values for system effectiveness that may be evident during testing. Environmental test plans are prepared by materiel developers, evaluators, assessors, and testers in various levels of detail during the acquisition cycle. Development and operational testers prepare plans for testing in laboratory and natural field/fleet environments.

- a. Laboratory test plans. This task pertains mainly to plans for materiel tests performed in environmental laboratories. The laboratory DETP provides the acquisition activity with plans for environmental laboratory tests early in the development cycle.
- b. Natural environment field/fleet tests. The information in paragraph 405.2 and following may be used as examples of some of the types of environmental testing procedures that are useful guidelines for some development and operational test plans. These plans are influenced automatically by previous environmental engineering tasks. Agency EES normally assist in preparing these plans.

405.2 Approach. Use decisions and data obtained through the tailoring process to determine the need for laboratory tests, specific criterion values (settings) for the individual environmental test methods in Part Two of this document, and the types and timing of development or operational tests in natural environments. Early coordination with the development and operational test community is essential to facilitate preparation of DETP's and to avoid costly omissions or duplications in environmental test planning. Consider the following:

- a. Probability of occurrence of specific environmental forcing functions, alone or in combination.
- b. Occurrence of similar environmental stresses in more than one life profile phase.
- c. Experience from other materiel similarly deployed/tested.
- d. Expected environmental effects and materiel failure modes.
- e. Expected effects on hardware performance and mission success.
- f. Likelihood of problem disclosure by a specific laboratory test method using a specific chamber test sequence/setting or natural environment test location/method.

405.3 Contents. Include the following in DETP's:

405.3.1 Pretest information. Include the following in the test plan as information that is required prior to conducting an environmental test.

- a. Background data of each item:
 - (1) Item nomenclature, model, serial number, manufacturer, etc.
 - (2) General appearance/condition.
 - (3) Specific physical anomalies.
 - (4) Environmental test history of the specific test item.
- b. Pretest data on the functional parameters that will be monitored during and after the main test. Use functional parameters and operational limits specified in the materiel specification or requirements document. If such specifications are not provided, establish and apply appropriate parameters/limits for the pretest, during the test, and the post test.
- c. Pretest information for facility operators. (Additional information may be required in specific methods in Part Two of MIL-STD-810F.)

MIL-STD-810F
1 January 2000
APPENDIX A

- (1) Test facilities (if applicable) including instrumentation.
 - (a) apparatus
 - (b) fixture(s)
 - (c) heating or cooling provisions
 - (d) requirements for combined environment
- (2) Test item installation details.
 - (a) procedures for installation including test item configuration relative to ant fixture
 - (b) orientation
 - (c) interconnections
- (3) Test instrumentation, monitoring, and recording.
 - (a) schedule
 - (b) individual test duration of exposure
 - (c) axes of orientation
 - (d) level criteria and tolerances
 - (e) method of test stress application
 - (f) shutdown procedures
 - (g) completion criteria
 - (h) test item functional and operational requirements for pretest, during test, and post test
- (4) Test procedure:
 - (a) schedule
 - (b) individual test duration of exposure
 - (c) axes of orientation
 - (d) level criteria and tolerances
 - (e) method of test stress application
 - (f) shutdown procedures
 - (g) completion criteria
 - (h) test item functional and operational requirements for pretest, during test, and post test

405.3.2 During test information. Include the following in the test plan as data to be collected during the test.

- a. Environmental design parameters and test criteria.
- b. Test configuration and quantity of items to be tested.
- c. Description of the testing to be performed, including specific climatic categories in which tests are conducted, subtests (e.g., initial examination (including packaging adequacy), pretest data (see paragraph 405.3.1, above), storage, performance, operational modes, human factors, safety, etc.), and failure criteria.
- d. Test procedure criteria, limits and tolerances.
- e. Test sequence and schedule.
- f. Test instrumentation, including, but not necessarily limited to:
 - (1) Specific instrumentation, calibration criteria, and procedures.
 - (2) Data to be collected and accuracies to be achieved.
 - (3) Description of all filtering performed on data.
- g. Descriptions of test installations, facilities, and equipment currently available to the contractor or available for procurement for the specific test program.
- h. Facilities/equipment required from the Government and dates required.

- i. Data reduction/analysis techniques and statistical criteria.

405.3.3 Post test information. Include the following in the test plan as information that is required after conducting the main test.

- a. Test item identification (manufacturer, model/serial number, etc.).
- b. Test equipment identification, including accessories.
- c. The actual test sequence (program) used or procedural anomalies.
- d. Deviation from the planned test program (including explanation).
- e. Performance data collected on the same parameters at the same operational levels as those of the pretest (including visual examination results and photographs, if applicable).
- f. If not tested in a chamber (e.g., vibration test), room ambient test conditions recorded periodically during test period.
- g. Other data as specified in the individual methods or materiel requirements document(s).
- h. Initial failure analyses.
- i. A signature and date block for the test engineer/technician to certify the test data.
- j. Photographic record of the test item, test fixture, and test apparatus, as appropriate.

MIL-STD-810F
1 January 2000
APPENDIX A

THIS PAGE INTENTIONALLY BLANK

TASK 406**ENVIRONMENTAL TEST REPORT (ETR)**406.1 Purposes.

- a. Environmental test reports are produced at various points in the acquisition process by development and operational testers. Specifications for reports of development and operational tests in specific environments are provided by development and operational test agencies, and therefore do not appear here. However, the information in paragraph 406.2 may be used as examples of some of the types of information that could appear in development and operational test reports.
- b. This task pertains mainly to the results of materiel tests performed in environmental laboratories. The ETR provides the acquisition activity with environmental laboratory test data early in the development cycle. The laboratory ETR is appropriate for design evaluation tests, operational worthiness tests, and qualification tests. Data from these laboratory tests serve as early warnings of unanticipated deviations from performance requirements. They support failure analyses and corrective actions related to the ability of materiel items to survive specific environmental conditions. These laboratory test reports (neither singularly nor in aggregate) are not substitutes for reports of development or operational tests conducted in natural field/fleet environments.

406.2 Task description. For each laboratory test conducted, provide the following:406.2.1 General information.406.2.1.1 Main body. Include the following in the main body of the report:

- a. Test item identification.
- b. Functional description of the failed or affected parts of the materiel.
- c. Causes of failures, if known.
- d. Proposed corrective actions if determinable.
- e. Test conditions (quantitative and qualitative data on environmental parameters of test).

406.2.1.2 Attachments. Include the following as attachments:

- a. Incremental test log (including time and events between failures).
- b. Laboratory failure analysis reports (which identify the physics-of-failure to the extent possible).
- c. A list of all other development and production activities where the same part failed, for example:
 - (1) Environmental tests
 - (2) Reliability tests
 - (3) Screening tests
 - (4) Bench checks
 - (5) Acceptance test procedures

406.2.2 Content requirements.406.2.2.1 Interim test reporting. Unless otherwise specified, accomplish this reporting by letter.

- a. Quick look. Report accomplishment of an environmental test by way of a quick look letter. Identify the specific test accomplished, salient test parameters and conditions, important test results, failures that occurred, and proposed corrective actions.

MIL-STD-810F
1 January 2000
APPENDIX A

- b. Test anomaly notification. When a test anomaly occurs, prepare a test anomaly letter to the procuring activity. Briefly summarize the test anomaly and include the following information:
- (1) Materiel serial numbers.
 - (2) Description of the anomaly (test interruption caused by test facility or test equipment failure, or materiel item failure).
 - (3) Environmental conditions surrounding the anomaly.
 - (4) Materiel failed part identification, if known at the time the anomaly letter is written.
 - (5) Test anomaly analysis and corrective action. Include an analysis of the causes of a test anomaly and the corrective action taken to prevent its recurrence. Prepare a short letter for one or more test anomalies that are simple in nature and have simple correction actions. For a materiel failure, prepare a more detailed notification letter.

406.2.2.2 Final test report. Document engineering development or qualification testing for each test (single environment or combined environmental test) for which testing was accomplished. Include in the final report for each test:

- a. The purpose of the test (i.e., engineering development, qualification, environmental worthiness, etc.).
- b. A list of criteria and issues pertaining to the test.
- c. Description of test item, including configuration identification of test hardware and photographs as appropriate.
- d. Description of test parameter, test duration, and any special conditions involved in the test.
- e. Description of test method, facility, and test procedure. Include a detailed description of how the test item was operated during each test and any controlled conditions.
- f. Test set-up diagram/photos. Show arrangements of test item relative to test equipment used.
- g. A list of all test equipment used in the test. Identify manufacturer, model, calibration status, and serial number for each item of test equipment listed.
- h. Location of environmental sensors such as accelerometers, microphones, thermocouples, etc., relative to test item. Use diagrams and photographs as appropriate.
- i. Description of test instrumentation system with particular emphasis given to any sensor averaging.
- j. Test results. Insert conversion tables (metric).
- k. Analysis of results relating data to criteria, including data reduction techniques and procedures showing how the data were related to the criteria, and a met/not met statement for each criterion.
- l. Record of critical values. In situations when environmental conditions limit or significantly degrade system performance (e.g., fog limiting infrared sensor system effectiveness, etc.), describe the limitation and designate it in the final test report as a critical threshold value.

APPENDIX B**DETAILED PROGRAM MANAGEMENT GUIDANCE**

A. General. Materiel must perform adequately under all environmental conditions associated with its service life; withstand those conditions in transit and storage, and maintain the desired level of reliability after environmentally harsh operation, storage, and transit. In order for this to happen, the effects that environmental conditions have on materiel effectiveness and safety must be determined, considered, analyzed, and integrated into all aspects of the acquisition process as indicated in Part One, figures 4-1 and 4-2. The guidance provided here and throughout this entire standard applies to the effects of environments on systems rather than the effects of systems on environmental quality. Therefore, the thrust of this standard should not be confused with Environmental Impact programs that focus on how to preserve and protect flora and fauna from service personnel, their materiel, and their activities. Conversely, this standard pertains to the effects that environments have on materiel system effectiveness.

B. Environments of intended use.

1. Several sections of the DoD 5000-series on Defense Acquisition address environmental considerations, stressing that systems must perform well in all environments of intended use (DoDD 5000.2-R, Appendix III, Parts III and IV. Unlike other technical areas (e.g., Reliability, Electromagnetic Environmental Effects, Human Factors, and environmental quality), no single section of that series is devoted to addressing natural or induced environmental factors. Therefore, this Part One of MIL-STD-810F provides basic program procedures for integrating environmental factors into the materiel acquisition process. This integration is accomplished through input to acquisition planning documents from the Mission Need Statement through the Test and Evaluation Master Plan to detailed test and evaluation plans and reports.
2. Environmental factors, working separately and in various combinations, are known to affect operation, transit, and storage of materiel. The DoD 5000-series documents point out that these factors include climate (temperature, humidity, solar radiation, rain, snow, icing phenomena, wind, blowing sand, dust and snow, ozone, freeze-thaw occurrences, fog, cloud ceiling height, and visibility); weather-related atmospheric obscuration (rain, snow, fog, cloud cover); terrain elements (slope, soil, and vegetation); induced elements (shock and vibration); and field/fleet conditions (obscuration, debris, emissions). Environmental Engineering Specialists (EES) are trained to assist acquisition personnel throughout the acquisition cycle to integrate these environmental concerns into requirements, design, test and evaluation documents, and procedures. See Appendix A of this document.

C. Balancing cost, schedule, and performance considerations. One of the basic policies governing defense acquisition covers the need to translate operational needs into stable, affordable programs. The key to this is using a concurrent systems engineering approach to help ensure reliable performance in all operational environments, when required. This entails designing a product to perform its assigned mission over time in intended operational environments and, at the same time, designing the system to survive non-operational environments (e.g., storage).

D. Trade-off considerations. Evaluate the need to operate in extreme environments against other factors such as cost, technical feasibility, tactics, doctrine, and materiel platforms. Higher costs, logistical problems, and operational difficulties associated with these environmentally rigorous areas could lead to selecting one of the following:

1. Special materiel capable of operation in extreme environmental areas.
2. Special materiel solely for extreme environments.
3. Modification kits that adapt new standard materiel or previously type-classified materiel to such use.
4. Special design values that are more extreme than normal tailoring would suggest for materiel whose failure to operate would be life-threatening.
5. Special design for materiel that would be useless or dangerous after one-time exposure.

E. Testing materiel for environmental effects. Developmental and evaluation plans must consider environmental effects outlined in the life cycle environmental profile. Both chamber tests and field/fleet tests serve useful purposes.

MIL-STD-810F
1 January 2000
APPENDIX B

Apply them at appropriate times during the acquisition cycle. Except for reasons of safety, chamber tests cannot be substituted for field/fleet development tests because unknown synergistic/antagonistic effects from combined/induced environments cannot be built into chamber/laboratory test methods. An example where chamber testing may be substituted for field/fleet testing is ammunition conditioning prior to test firing. Following are some guidelines for laboratory testing, natural field/fleet development testing and operational testing.

1. Laboratory testing. Conduct laboratory tests early in the development stage to screen materiel for environmentally caused problems that may degrade materials, performance, or reliability. Conduct laboratory tests according to the general tailoring guidance in Part One and the specific testing guidelines in Part Two of this standard.
2. Natural field/fleet development testing. Conduct natural environmental field/fleet development tests to determine the true effects of the real environment. This will allow system assessment of synergistic/antagonistic effects of natural environmental factors combined with human factors and induced factors such as shock/vibration, smoke/obscurants and electromagnetic interference. Use established natural climatic test centers and standard test procedures to obtain data that may be compared to previous/following test data and to develop data bases that may be used for simulations.
3. Operational testing. Conduct operational testing in natural environments that are as realistic as possible. When operational testing cannot subject materiel to the desired ranges of environmental stresses and deterioration that may be encountered during actual operation, storage, and transit, development test environmental effects data may be substituted for operational test environmental effects data.

F. Analytic alternatives to testing actual hardware. In some instances, there may be analytic alternatives to testing actual systems or hardware prototypes in laboratories or in field/fleet environments. An EES can help to establish an engineering basis for selecting and implementing such alternatives. When alternatives to testing actual hardware or prototypes are chosen, Task 401, Environmental Engineering Master Plan, must contain the rationale for their selection including an explanation of the cost savings, other benefits and risks to system effectiveness/safety. (See Part One, paragraph 4.1.2.b; Appendix A, Task 401; and Appendix B, paragraph F.) Analytic alternatives include, but are not necessarily limited to the following.

1. Modeling and simulation. To the extent that data bases are available and the predictive validity of simulation techniques has been verified, use environmental effects data/knowledge bases, warfighter simulation techniques, and virtual proving grounds, rather than hardware test techniques, to predict performance and reliability characteristics of competing concepts and designs. Simulation can reduce high costs involved in producing and testing hardware prototypes. Although artificial intelligence and software simulations may be integral parts of models, neither these types of data nor data from chamber tests should be used to validate models. The most sound criteria for developing and validating models and simulations come from real world, field/fleet data or knowledge bases. To that end, all fields of science and engineering can help to save costs through simulation by developing or contributing to data bases or knowledge bases that cover the entire domain of environmental effects. (See Appendix C, paragraph B.)
2. Testing coupon samples. In some instances, particularly in laboratory tests and natural field/fleet exposure/surveillance tests, there may be significant savings by using coupon samples instead of entire systems when specific materials are the central acquisition issue.
3. Acceptance by similarity. In cases where materiel considered for testing is nearly identical to materiel already tested, and there is no reason to believe that the differences between them would pose an environmentally induced problem, the program manager may consider accepting the materiel by virtue of its similarity to the similar materiel already accepted.

G. Type classification process. Environmental considerations influence the type classification process. For materiel that is designated by the combat developer to be critical to combat success, type classification or fielding may be barred if environmental testing reveals that environmental effects were not considered adequately and incorporated in the design of the system. Additionally, successful system performance and reliability in natural environments are listed as critical issues in Milestone III (production) decisions.

APPENDIX C**ENVIRONMENTAL TAILORING GUIDELINES FOR ENVIRONMENTAL
ENGINEERING SPECIALISTS (EES)**

A. General. Environmental tailoring is the process of choosing or altering materiel designs and tests so that a given materiel will be manufactured and tested to operate reliably when influenced by the various environmental factors and levels it is expected to experience throughout its service life. The tailoring process, broadly speaking, also includes preparing or reviewing engineering task and planning documents to help ensure realistic environments are given proper consideration throughout the acquisition cycle.

1. Objective of tailoring. Tailoring helps to ensure that materiel will be neither under- nor over-designed, nor under- nor over-tested with respect to specific environments it is expected to see during its service life. The tailoring process outlined in Part One, figure 4-1 shows that it is important not to take design and test criteria directly from natural environment data (descriptions of natural environmental factors or forcing functions found in STANAG 2895, MIL-HDBK-310 AND AR 70-38 or elsewhere), but rather from the transformations that such forcing functions create as they interact with a platform environment (static or dynamic materiel platforms, including induced environmental changes that result from operating the materiel itself).
2. Tailoring process. Fundamental to the tailoring process is the ability to apply common scientific/engineering sense to environmental life cycle "homework," focusing on realistic materiel design and test criteria. To execute a quality tailoring process, it is necessary to give proper consideration to environments that occur throughout the materiel's life cycle. Completing Tasks 401 through 406 in Appendix A will help program managers and environmental engineering specialists to apply proper environmental considerations throughout the materiel acquisition cycle. Part One, figure 1-1 explains the tailoring process in terms of the environmental engineering tasks (Appendix A) required by this standard, thereby serving as a guide for program managers, design engineers, environmental engineering specialists, test engineers, and facility operators. Use Task 401, Environmental Engineering Management Plan (EEMP), and Task 402, Life Cycle Environmental Profile (LCEP) as the main guides for tailoring. Careful completion of each of these tasks will help ensure correct environments are identified for tests, that engineering development as well as qualification tests are phased properly into the materiel's acquisition program, and that environmental test conditions are appropriate and traceable to realistically encountered life cycle conditions.

B. Environmental testing domain.

1. Acquisition personnel. Acquisition personnel, with the assistance of an EES, should derive environmental development and operational test plans according to the environmental tailoring process shown in Part One, figures 1-1 and 4-1. All types of environments need to be addressed. In the broader sense, environmental considerations go beyond basic climatic factors (such as temperature and humidity) to complex combinations and sequences of factors (such as rapid heating and cooling in high humidity, intermittent rainfall, high microbial activity, and vibration conditions) that can combine synergistically or antagonistically to influence materiel effectiveness. Therefore, the domain of environmental testing goes beyond the laboratory test methods appearing in Part Two of this standard. The broader objective of environmental effects tailoring is to determine optimum design and test specifications for the expected environmental classes such as:
 - a. Natural
 - Climate
 - Terrain
 - b. Induced

MIL-STD-810F
1 January 2000
APPENDIX C

Shock/vibration
Noise
Light
Electromagnetic radiation

c. Constructed

Built up areas
Transportation facilities
Communication facilities
Energy sources

d. Conflict

Permanent fortifications
Persistent debris/emissions
Transitory obscurants/emissions

2. Performance of laboratory tests. Conduct the laboratory tests in Part Two early in the acquisition cycle to the extent that they can reveal environmentally caused materiel problems early in the acquisition process before the problems become costly to solve. It is important to note that these laboratory test methods cannot be used as substitutes for field/fleet test methods that measure materiel performance, reliability, safety, and other important aspects of materiel evaluation in natural field/fleet environments. The reason is inherent in the many combined effects that can occur in nature and on materiel platforms in field/fleet operations. By performing the tasks in Appendix A, EES from government and industry can assist combat developers, materiel developers, program managers, etc., to select factors within each of the environmental classes, tailoring them to the specific materiel application. Different EES may be used in different phases of the acquisition cycle (e.g., system design and system assessment) to maintain independence of those functions.

C. Climatic categories. One of the vital challenges of the tailoring process is to design materiel to operate in climates of the world in which the materiel is expected to be deployed. Five Climatic Categories may be called out in mission need, materiel requirement, design, and test documents for tailoring purposes: Basic, Hot, Cold, Severe Cold, and Coastal/Ocean. The Basic Climatic Category covers a broad range of climatic conditions in which most materiel should operate and survive storage and transportation. Coastal/Ocean is a relatively new category that may not appear in other documents that describe climates. All categories are described below. Within each category there are one or more "daily cycles" primarily based on variations in temperature and relative humidity levels. All Climatic Categories, except for Coastal/Ocean, are defined in table C-1 and mapped on figure C-1. For further details on the Coastal/Ocean Climatic Category and other outdoor ambient worldwide and regional climates, see STANAG 2895, MIL-HDBK-310, and AR 70-38.

1. Hot Climatic Category. This Climatic Category includes most of the hot-dry low-latitude deserts of the world. During summer in these areas, outdoor ambient air temperatures above 43°C (110°F) occur frequently. However, except for a few specific places, outdoor ambient air temperatures will seldom be above 49°C (120°F). These approximate temperatures of the free air in the shade approximately 1.5 to 2 meters (about 5 or 6 feet) above the ground (in an instrument shelter). The thermal effects of solar loading can be significant for materiel exposed to direct sunlight, but will vary significantly with the exposure situation. The ground surface can attain temperatures of 17 to 33°C (30 to 60°F) higher than that of the free air, depending on the type/color of the ground surface, radiation, conduction, wind, and turbulence. Air layers very close to the surface will be only slightly cooler than the ground, but the decrease in temperature with height above the surface is exponential. Temperatures at approximately 0.5 to 1 meter (about 2 to 3

feet) will be only slightly warmer than that observed in an instrument shelter at about twice that height.¹ In winter, such temperatures are likely to be in the same range as for the Basic Climatic Category. If materiel is designed only for the hot climate, seek a specially tailored low outdoor ambient air temperature design value. Small portions of this area are sometimes subject to very high absolute humidity. However, in these hot-wet areas, the highest outdoor ambient air temperatures and highest dew points do not occur at the same time.

2. Basic Climatic Category. This includes the most densely populated and heavily industrialized parts of the world as well as the humid tropics. The entire range of basic design conditions does not necessarily occur in any one place. Each single condition (high temperature, low temperature, high humidity) occurs in a wide area. When taken together, the design values should be valid for materiel used throughout the area.
 - a. Humid tropic zone. Humid tropic areas are included in the Basic Climatic Category rather than being considered an extreme category because humid tropic temperatures are moderate and their humidity levels are equaled at times in some of the other mid-latitude areas. The feature of the humid tropics most important for materiel system design is the persistence of high humidity coupled with moderately high temperatures throughout the year. This combined environmental condition not only promotes corrosion, but also greatly increases insect and microbiological damage.
 - b. Intermediate zone. These are mid-latitude areas that do not combine higher temperatures with higher humidities throughout the year, and at the same time are not climatically extreme enough to meet the conditions for Hot nor Cold Climatic Categories. This zone includes the daily cycles shown in table C-I, plus a condition known as "cold-wet" which can occur within the mild cold daily cycle at or near the freezing point (2 to -4°C (35 to 25°F)) with relative humidity tending toward saturation (100 to 95% RH) and negligible solar radiation.
3. Cold and Severe Cold Climatic Categories. These areas include northern North America, Greenland, northern Asia, and Tibet. In the Cold Climatic Category, the temperature during the coldest month in a normal year may be colder than the Basic Climatic Category cold extreme of -32°C (-25°F). In the Severe Cold areas, the temperature during the coldest month in a normal year may be colder than the Cold Climatic Category extreme of -46°C (-50°F). Temperatures colder than -51°C (-60°F) occur no more than 20 percent of the hours in the coldest month of the coldest part of the area (northern Siberia) where temperatures as low as -68°C (-90°F) have been recorded. Because extremely low temperatures are not controlled by a daily solar cycle, they persist for a long enough period of time to cause materiel to reach equilibrium at extremely low temperatures.
4. Coastal/Ocean Climatic Category. These areas include open seas and coastal ports north of 60°S. The area south of 60°S, the Antarctic Circle area, is excluded because of extremely harsh conditions that would call for special, case-by-case designs outside of the scope of the conditions/procedures covered in this standard, and because military conflicts are highly unlikely in this international area. In general, materiel should be designed to operate in the Coastal/Ocean Climatic Category during all but a small percentage of the time when routes may be closed to navigation because of sea ice. See STANAG 2895, MIL-HDBK-310, and AR 70-38 for details.

D. Considerations for determining climatic categories for materiel systems.

1. Normal environment considerations. All combat and combat support systems should be designed for at least the Basic Climatic Category, meaning that design temperatures will include the outdoor ambient air temperatures range of -32°C through +43°C. See figure C-1 and table C-I.
2. Extreme environment considerations. Materiel intended to be deployed or used in extreme climates (hot, cold, and severe cold), in areas with extreme non-thermal weather conditions (such as blowing sand and dust), or in areas with mobility-restricting terrain conditions (such as tundra soil and heavily forested areas)

¹ Synopsis of Background Material for MIL-STD-210B, Climatic Extremes for Military Equipment, Norman Sissenwine & Rene' V. Cormier, 24 January 1974.

MIL-STD-810F
1 January 2000
APPENDIX C

will require additional planning, design, and testing considerations. In addition to being prepared for the Basic Climatic Category, most materiel will need to be designed, developed, tested, and evaluated for operation, storage, and transit conditions in areas of the world that experience extreme temperatures. According to STANAG 2895, MIL-HDBK-310, and AR 70-38, to qualify as an area of extreme temperature, the area must meet one of the following two conditions: (1) have one percent or more of the hours in the hottest month equal to or exceeding 43°C; (2) have one percent or more of the hours in its coldest month equal to or lower than -32°C. The areas that have more extreme temperatures than these are the Hot, Cold, and Severe Cold Climatic Categories shown on figure C-1 and table C-I.

3. Special considerations for materiel categories/modes.
 - a. Storage and transit. When preparing a materiel's mission profile, life cycle environmental profile, or an ORD, identify storage and transport environments and environmental limits that the materiel is required or desired to withstand (e.g., temperature, humidity, vibration levels, etc.). For severe storage/transport conditions that would generate high materiel costs to withstand, consider modifying storage/transit/platform conditions/designs as tradeoffs to materiel design requirements. Environmental conditions for storage and transit modes may be more severe than those of operational modes because of the possibility of induced/combined environments (e.g., heat, humidity, shock, vibration, etc.), higher levels of some factors (e.g., high temperature in temporary open storage or during delays between transit modes), or greater materiel exposure times.
 - b. Design of sheltered materiel. This paragraph pertains to materiel that is intended to be deployed/operated within shelters. In this case, the shelter becomes the materiel platform, and the environmental characteristics that the sheltered materiel will see depend upon the location and design of the shelter. Not only design sheltered materiel to be transported (as part of a shelter assembly) to its use location, but also design it to be used under the conditions that exist within the shelter when the shelter is operated in the areas stipulated in its requirements documents. This includes storage conditions within shelters that are not controlled environmentally as well as operational conditions where environments are controlled. Also, design sheltered materiel to withstand environmental effects that occur during materiel relocation when the shelter is not available. The materiel developer should:
 - (1) Develop or supply protective devices or modification kits, if required, that will permit shipment, storage, and operational use of such materiel in the environmental conditions for which it is intended.
 - (2) Indicate by distinct marking at appropriate places on the materiel (where size makes this feasible), and by warning statements in technical manuals, the actual climatic stress limits that should not be exceeded in operational and non-operational modes.
 - c. Effects of environments on soldier/system interfaces. As part of each materiel analysis conducted during the materiel acquisition cycle, the developmental and operational evaluators must consider environmental effects on the soldier/system interface. These considerations are also applicable to nondevelopmental items (NDI) and to foreign materiel acquired for military use.
 - d. Environmental considerations for potentially dangerous materiel. Design potentially dangerous materiel (e.g., ammunition and explosive materials/materiel, etc.) to include safety requirements based on the long-term, worldwide temperature extremes detailed in STANAG 2895, MIL-HDBK-310, and AR 70-38, even though the materiel may not be intended for operational use at these extremes. This will prevent situations where explosive or other dangerous materiel that is developed for less than worldwide deployments is transported, stored, or used inadvertently in areas of unexpected extreme conditions, thus possibly resulting in critical or catastrophic failure.

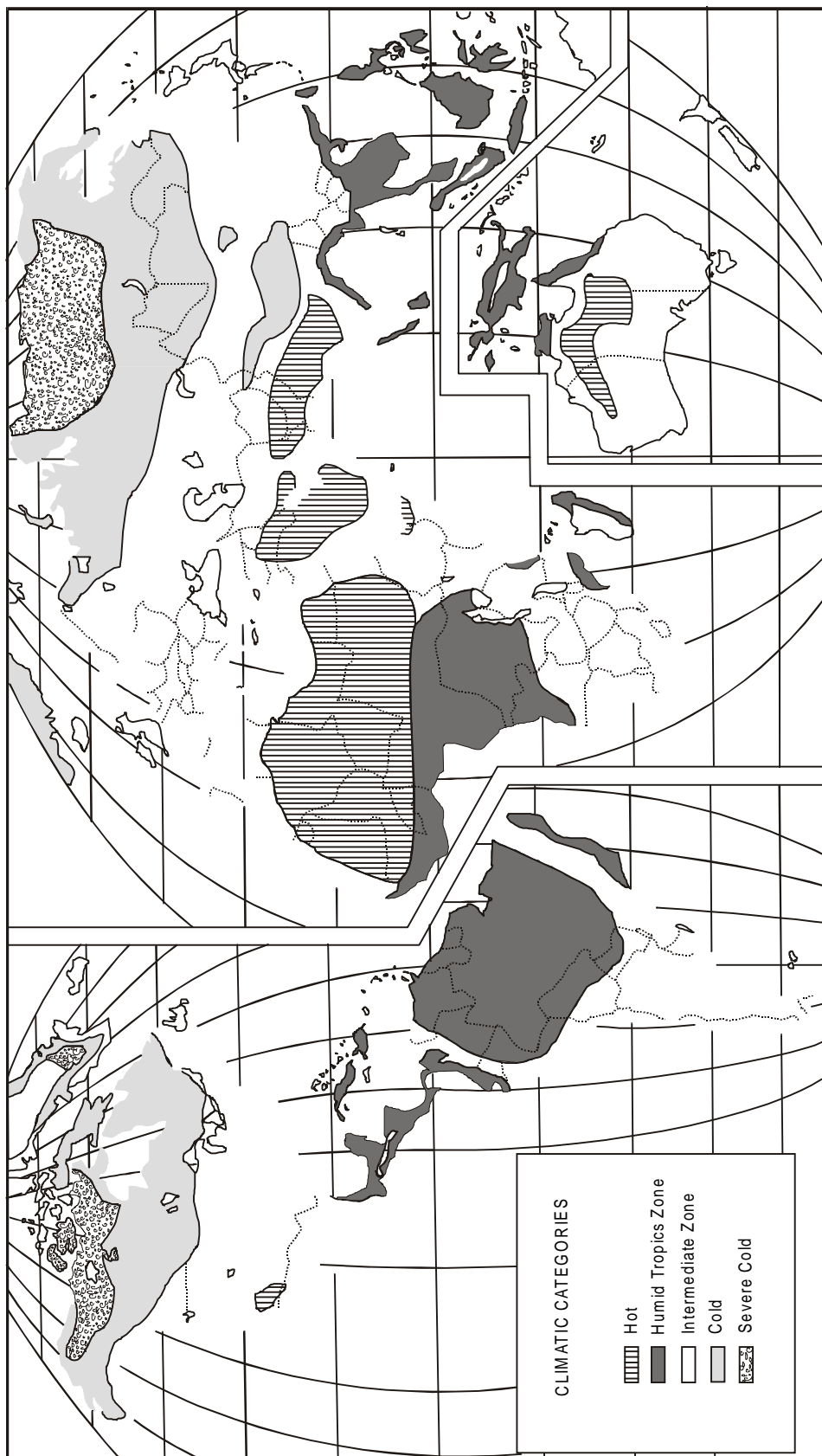

FIGURE C-1. Areas of occurrence of climatic categories.

MIL-STD-810F
1 January 2000
APPENDIX C

TABLE C-I. Summary of climatic conditions and daily cycles of temperature, solar radiation, and relative humidity.

| CLIMATIC CATEGORY | | DAILY CYCLE ¹ | OUTDOOR AMBIENT CONDITIONS | | |
|-------------------|----------------------|-----------------------------------|---|--|----------------------------------|
| | | | Air Temperature °C ² (°F) | Solar Radiation W/m ² (BPH) ³ | Relative Humidity ⁴ % |
| HOT | | HOT-DRY (A1) | 32 to 49 (90 to 120) | 0 to 1120 (0 to 355) | 8 to 3 |
| | | HOT-HUMID (B3) | 31 to 41 (88 to 105) | 0 to 1080 (0 to 343) | 88 to 59 |
| BASIC | HUMID-TROPIC ZONE | CONSTANT HIGH HUMIDITY (B1) | Nearly Constant 24 (75) | Negligible | 95 to 100 |
| | | VARIABLE HIGH HUMIDITY (B2) | 26 to 35 (78 to 95) | 0 to 970 (0 to 307) | 100 to 74 |
| | INTERMEDIATE ZONE | BASIC HOT (A2) | 30 to 44 (86 to 111) | 0 to 1120 (0 to 355) | 44 to 14 |
| | | MILD COLD (C0) | -19 to -6 (-2 to 21) | Negligible | Tending Toward Saturation |
| | | BASIC COLD (C1) | -32 to -21 (-25 to -5) | Negligible | Tending Toward Saturation |
| | COLD | | COLD (C2) | -46 to -37 (-50 to -35) | Negligible |
| SEVERE COLD | | SEVERE COLD (C3) | -51 (-60) | Negligible | Tending Toward Saturation |

¹ Designations in parentheses refer to corresponding climatic categories in Quadripartite Standardization Agreement 360, "Climatic Environmental Conditions Affecting the Design of Military Materiel," and NATO STANAG 2895, "Extreme Climatic Conditions and Derived Conditions for Use in Defining Design/Test Criteria for NATO Forces Materiel."

² °C values (rounded to the nearest whole degree) derived from data obtained/established on °F scale.

³ BPH represents British Thermal Units per square foot per hour.

⁴ Sequence of RH presentation corresponds to sequence of air temperatures shown (e.g., for HOT-DRY daily cycle, 8% RH occurs at 32°C; 3% RH occurs at 49°C).

APPENDIX D¹**TERMINOLOGY FOR DYNAMIC (MECHANICAL) TEST METHODS**

- a. AC-coupling. In signal processing, this term implies the removal of any zero frequency information from the time history trace. In digitizing a signal, the analog-to-digital converter is said to be AC-coupled, if there exists a high pass filter in the digitizing process. Typically, piezoelectric devices are AC-coupled because of their inability to respond to static voltages.
- b. Autocorrelation function. For $x(t)$, a function of time, the autocorrelation function, $R_{xx}(\tau)$, is defined to be the following average over an averaging time, T ,

$$R_{xx}(\tau) = \frac{1}{T} \int_0^T x(t)x(t+\tau)dt$$

If the average $R_{xx}(\tau)$ is also a function of time, t , ($R_{xx}(\tau, t)$) such that

$$R_{xx}(\tau, t) = \frac{1}{T} \int_0^T x(t+u)x(t+u+\tau)du$$

then, this is a form of nonstationary autocorrelation function.

- c. Autospectral density function. For a stationary (ergodic) random process $\{x(t)\}$ for which the finite Fourier transform of $x(t)$ is given by:

$$X(f, T) = \int_0^T x(t)e^{-j2\pi ft} dt \quad -\infty < f < \infty$$

the two-sided autospectral density of $x(t)$ is defined by:

$$S_{xx}(f) = \lim_{T \rightarrow \infty} \frac{1}{T} E \left[|X(f, T)|^2 \right] \quad -\infty < f < \infty$$

for E , the expected value operator. A one-sided estimate of the autospectral density function of $x(t)$ over n_d distinct records, each of length T , is given by the following average of finite Fourier transforms:

$$\hat{G}_{xx}(f) = \frac{2}{n_d T} \sum_{i=1}^{n_d} |X_i(f, T)|^2 \quad 0 \leq f < \infty$$

In processing, the distinct records of length T may be windowed in the time domain to reduce spectral leakage, and the processing may be "overlapped" to restore degrees of freedom lost in the windowing process. Other processing options include the estimate processing in the frequency domain convolving basic frequency domain estimates with a selected window function defined in the frequency domain.

- d. Classical pulse. A short duration transient time history defined by $p(t)$ for $0 \leq t \leq T < \infty$, having the form of a half-sine, a square wave, a triangular wave, a ramp with a terminal peak amplitude, a ramp with an initial peak amplitude, or a general trapezoid.
- e. Combination control. A form of vibration system control that combines response control and force limit control in order to ensure measured or specified test spectra levels are met without inputs that provide for substantial overtest or undertest. Combination control requirements arise as a result of impedance mismatches between measured in-service materiel configuration response and laboratory test materiel configuration response. Use of response control alone may result in severe overtest spectra levels or undertest spectra levels at various frequencies.

¹ In this Appendix, the symbol "T" represents a finite time and is such that $0 < T < \infty$, and the symbol "F" represents a finite frequency and is such that $0 < F < \infty$ unless otherwise specified.

MIL-STD-810F
1 January 2000
APPENDIX D

- f. Cross-correlation function. For $x(t)$ and $y(t)$ functions of time, the cross correlation function, $R_{xy}(\tau)$, is defined to be the following average over an averaging time, T :

$$R_{xy}(\tau) = \frac{1}{T} \int_0^T x(t)y(t + \tau)dt$$

If the average $R_{xy}(\tau)$ is also a function of time, t , ($R_{xy}(\tau, t)$) such that

$$R_{xy}(\tau, t) = \frac{1}{T} \int_0^T x(t+u)y(t+u+\tau)du$$

then, this is a form of nonstationary cross correlation function.

- g. Cross-spectral density function. For stationary (ergodic) random processes $\{x(t)\}$ and $\{y(t)\}$ for which finite Fourier transforms of $x(t)$ and $y(t)$ are respectively,

$$X(f, T) = \int_0^T x(t) e^{-j2\pi ft} dt \quad -\infty < f < \infty$$

$$Y(f, T) = \int_0^T y(t) e^{-j2\pi ft} dt \quad -\infty < f < \infty$$

the two-sided cross-spectral density function of $x(t)$ and $y(t)$ is defined by:

$$S_{xy}(f) = \lim_{T \rightarrow \infty} \frac{1}{T} E \left\{ \left| X^*(f, T) Y(f, T) \right| \right\} \quad -\infty < f < \infty$$

An estimate of the one-sided cross-spectral density function of $x(t)$ and $y(t)$ over n_d distinct records, each of length T , is given by the following average of finite Fourier transforms:

$$\hat{G}_{xy}(f) = \frac{2}{n_d T} \sum_{i=1}^{n_d} X_i^*(f, T) Y_i(f, T) \quad 0 \leq f < \infty$$

In processing, the distinct records of length T may be windowed in the time domain to reduce spectral leakage, and the processing may be "overlapped" to restore degrees of freedom lost in the windowing process. Other processing options include the estimate processing in the frequency domain convolving basic frequency domain estimates with a selected window function defined in the frequency domain.

- h. DC-coupling. In signal processing, this term implies the retention of all zero frequency information in a time history trace. In digitizing a signal, the analog-to-digital converter is said to be DC-coupled if there is no high pass filter in the digitizing process. Typically, piezoresistive devices are DC-coupled because of their ability to retain the magnitude of static voltages.
- i. Energy autospectral density function. For a time limited history $x(t)$ defined for $0 \leq t \leq T < \infty$ with finite Fourier transform

$$X(f, T) = \int_0^T x(t) e^{-j2\pi ft} dt \quad -\infty < f < \infty$$

the two-sided energy autospectral density function of $x(t)$ is given by:

$$L_{xx}(f, T) = E \left[\left| X(f, T) \right|^2 \right] \quad -\infty < f < \infty$$

for E , an ensemble average over n_d available single records. A one-sided estimate of this function is given by:

$$\hat{L}_{xx}(f, T) = 2 \left| X(f, T) \right|^2 \quad 0 \leq f < \infty$$

To reduce the variance in the estimate $\hat{L}_{xx}(f, T)$, a direct average of n_d independent “equivalent” time limited events, $x(t)$, may be computed. The events generally will be replications of a given experiment, and will be considered as a time history ensemble. In processing, $x(t)$ will not be windowed in the time domain, but include all significant energy in the experiment.

- j. Energy cross-spectral density function. For time and band limited time histories $x(t)$ and $y(t)$ defined for $0 \leq t \leq T < \infty$ with finite Fourier transforms.

$$X(f, T) = \int_0^T x(t) e^{-j2\pi ft} dt \quad -\infty < f < \infty$$

$$Y(f, T) = \int_0^T y(t) e^{-j2\pi ft} dt \quad -\infty < f < \infty$$

the two-sided energy cross-spectral density function of $x(t)$ and $y(t)$ is given by:

$$L_{xy}(f, T) = E \left\{ \left| X^*(f, T) Y(f, T) \right| \right\} \quad -\infty < f < \infty$$

for E , an ensemble average over n_d available single records. A one-sided estimate of this function is given by:

$$\hat{L}_{xy}(f, T) = 2 \left| X^*(f, T) Y(f, T) \right| \quad 0 \leq f < \infty$$

To reduce the variance in the estimate $\hat{L}_{xy}(f, T)$, a direct average of n_d independent “equivalent” time limited events, $x(t)$, $y(t)$, may be computed. The events generally will be replications of a given experiment, and will be considered as a time history ensemble. In processing, neither $x(t)$, $y(t)$ will be windowed in the time domain.

- k. Energy frequency response function. For time limited histories $x(t)$ and $y(t)$ defined for $0 \leq t \leq T < \infty$ with energy cross-spectral density function $L_{xy}(f, T)$ and energy autospectral density function $L_{xx}(f, T)$, the energy frequency response function is defined as:

$$H_{xy}(f, T) = \frac{L_{xy}(f, T)}{L_{xx}(f, T)} \quad -\infty < f < \infty$$

A one-sided estimate of this function is given by:

$$\hat{H}_{xy}(f, T) = \frac{\hat{L}_{xy}(f, T)}{\hat{L}_{xx}(f, T)} \quad 0 \leq f < \infty$$

where $\hat{L}_{xy}(f, T)$ and $\hat{L}_{xx}(f, T)$ may represent averages over a given ensemble of n_d independent equivalent time limited events, $x(t)$ and $y(t)$. Averaging may reduce the variance in the estimate $\hat{H}_{xy}(f, T)$ which is taken as the quotient of two stable averages $\hat{L}_{xy}(f, T)$ and $\hat{L}_{xx}(f, T)$.

Note: The term “frequency response function” is used here preserving the term “transfer function” for the Laplace transform of the unit impulse response function.

- l. Ensemble. A collection of sample time history records from a single random process where each of the time history records is defined over the same duration time interval. The notation for an ensemble representing a random process $x(t)$ is $\{x(t)\}$. If the ensemble has N members over time $0 \leq t \leq T < \infty$, the notation is $\{x_i(t) : 0 \leq t \leq T, i = 1, 2, \dots, N\}$.
- m. Ergodic (nonergodic) process. A random process that may be represented by an ensemble of time history records for which the time averaged parameters of any one time history record from the ensemble is representative of the time averaged parameters of the ensemble of time history records. An ergodic

MIL-STD-810F
1 January 2000
APPENDIX D

random process is a stationary random process. A random process that does not satisfy the above definition is termed nonergodic. Procedures for the determination of nonergodicity of a random process may take a number of forms. A stationary process may be also ergodic, whereas an ergodic process is always stationary.

- n. Filter. Fourier spectrum transformation of a given input time history, $x(t)$, in order to produce a desired effect. Such filtering may be through band limiting the time history spectra through lowpass, highpass, bandpass, or bandstop forms of filtering. Filtering may be performed equivalently in either the time domain or the frequency domain. If the filtering transformation preserves the phase relationships between the input and output frequency components, the filter is referred to as a linear phase filter. If the filtering transformation distorts the phase relationships between input and output frequency components, the filter is referred to as a nonlinear phase filter. Further terminology related to filtering is provided in method 516.5 and method 517.
- o. Force limit control. A form of vibration system control that attempts to limit the input interface test levels to those levels measured or specified at the interface. In general, the levels measured or specified at the interface are in terms of force input to the test item interface or the test item interface mount.
- p. Fourier transform and finite Fourier transform. For a time history, $x(t)$, defined for $-\infty < t < \infty$, the Fourier transform of $x(t)$ is defined as a complex-valued function of frequency, f , when the integral exists. $X(f)$ is termed the direct Fourier transform of $x(t)$ and $x(t)$ is termed the inverse Fourier transform of $X(f)$.

$$X(f) = \int_{-\infty}^{\infty} x(t)e^{-j2\pi ft} dt \quad -\infty < t < \infty$$

For a time history $x(t)$, defined for $0 \leq t \leq T < \infty$, the finite Fourier transform of $x(t)$ is defined as a complex-valued function of frequency f .

$$X(f, T) = \int_0^T x(t)e^{-j2\pi ft} dt \quad -\infty < t < \infty$$

$X(f, T)$ is termed the direct finite Fourier transform of $x(t)$; and $x(t)$ is termed the inverse finite Fourier transform of $X(f, T)$. The finite Fourier transform always exists for well defined $x(t)$, $0 \leq t \leq T < \infty$. ($X^*(f, T)$ represents the complex conjugate of $X(f, T)$.)

- q. Gaussian (non-Gaussian) process. For $x(t)$, a stationary random process that obeys the following probability density function at any time t for μ_x and σ_x constants:

$$p(x) = \left(\sigma_x \sqrt{2\pi}\right)^{-1} \exp\left[-\frac{(x - \mu_x)^2}{2\sigma_x^2}\right] \quad -\infty < x < \infty$$

then $x(t)$ will be considered to be a Gaussian stationary random process. Conversely, for $x(t)$ a random process that does not obey the probability density function at some time, t , will be considered to be non-Gaussian. This definition is not restricted to ergodic random processes.

- r. Inverse Fourier transform and inverse finite Fourier transform. For the Fourier transform $X(f)$, defined for $-\infty < f < \infty$, the inverse Fourier transform of $X(f)$ is defined as a real valued function of time, t :

$$x(t) = \frac{1}{2\pi} \int_{-\infty}^{\infty} X(f)e^{j2\pi ft} dt \quad -\infty < t < \infty$$

when the integral exists. $x(t)$ is termed the inverse Fourier transform of $X(f)$, and $X(f)$ is termed the Fourier transform of $x(t)$.

For the finite Fourier transform $X(f, T)$ defined over a frequency band of $-F \leq f \leq F$, the inverse finite Fourier transform of $X(f, T)$ is defined as a real-valued function of time, t :

$$x(t) = \frac{1}{2\pi} \int_{-F}^F X(f, T) e^{j2\pi ft} df \quad -\infty < t < \infty$$

$x(t)$ is termed the inverse finite Fourier transform of $X(f, T)$ and $X(f, T)$ is termed the finite Fourier transform of $x(t)$, $0 \leq t \leq T < \infty$. The inverse finite Fourier transform always exists for well defined $X(f, T)$, $-F < f < F$ and is periodic in t .

- s. Linear system. A system in which scaled and additive inputs result in scaled and additive outputs. That is, for $y = h(x)$ representation of a linear system, h , then for c , a constant, and x , x_1 , x_2 inputs the following input/output relationships are defined:

System homogeneity: $cy = ch(x) = h(cx)$

System superposition: $y_1 + y_2 = h(x_1) + h(x_2) = h(x_1 + x_2)$

- t. Mean (ensemble). For an ensemble $\{x_i(t): 0 \leq t \leq T < \infty, i = 1, 2, \dots, N\}$ of N time history records, $x_i(t)$, with a mean $\mu(t)$, $0 \leq t \leq T$, an unbiased estimate of the mean of the ensemble at time t is given by:

$$\hat{m}(t) = \frac{1}{N} \sum_{i=1}^N x_i(t) \quad 0 \leq t \leq T$$

$\mu(t)$ is the first moment of the random process $\{x(t)\}$.

- u. Mean-square (ensemble). For an ensemble $\{x_i(t): 0 \leq t \leq T < \infty, i = 1, 2, \dots, N\}$ of N time history records with a mean square $p(t)$, $0 \leq t \leq T$, an unbiased estimate of the mean-square for the ensemble at time t is given by:

$$\hat{p}(t) = \frac{1}{N} \sum_{i=1}^N x_i^2(t)$$

$p(t)$ is the second moment of the random process $\{x(t)\}$.

- v. Nonlinear system. A system that is not linear in that either the system homogeneity requirement or the system superposition requirement or both are violated. For $y = h(x)$ representation of system h , then for c , a constant, and x_1 , x_2 inputs, either

$$cy = ch(x) \neq h(cx)$$

or
$$y_1 + y_2 = h(x_1) + h(x_2) \neq h(x_1 + x_2)$$

or both.

- w. Nonstationary process. A nonstationary random process is an ensemble of time history records that cannot be defined to be stationary. In general, the statistical properties of a nonstationary process are a function of time and not invariant with respect to time translations. In this standard, if either the mean (first moment) estimate or mean-square (second moment) estimate, or both from a random process ensemble vary with time over the ensemble, the random process is considered nonstationary. If the ensemble has a deterministic component that varies in time, the ensemble may or may not be considered nonstationary depending on whether the random part of the ensemble is nonstationary or stationary.
- x. Pulse. For purpose of this standard, a pulse is a finite duration deterministic or random time history. In cases in which the pulse is related to the response in testing of materiel, the duration is generally no longer than five times the period of the lowest natural frequency of the materiel under consideration, and may be substantially shorter.
- y. Random process. A random process is represented by an ensemble of time history records that have properties described in terms of parameters estimated from statistical computations at selected times. In this standard it will be assumed that one or more sample records from the random process are related to a repeatable experiment that completely describes the phenomenon under consideration.
- z. Response control. A form of vibration system control that attempts to match the response of materiel at one or more points with measured or specified vibration data at one or more points on the materiel.

MIL-STD-810F
1 January 2000
APPENDIX D

Vibration control system operational procedures provide for a variety of response matching options, e.g., single point control, multipoint control, average control, extreme control, etc.

- aa. Root-mean-square (ensemble). For an ensemble $\{x_i(t): 0 \leq t \leq T < \infty, i = 1, 2, \dots, N\}$ of N time history records with a mean square $p(t)$, $0 \leq t \leq T$, (estimated by $\hat{p}(t)$), an estimate of the root-mean-square for the ensemble at time t is given by:

$$\hat{r}(t) = \sqrt{\hat{p}(t)} = \sqrt{\frac{1}{N} \sum_{i=1}^N x_i^2(t)}$$

- bb. Sample function. One particular realization of a random process that may be used to form an ensemble representation for the random process.
- cc. Spectrum. The representation of a time history in terms of a function of frequency. The representation, in general, will occur as a result of analyzing the time history with the Fourier transform and may be real or complex. (In the case of time history data analyzed by way of the shock response spectrum engineering tool, the representation is in terms of real amplitude and the natural frequency of a single degree of freedom system.)
- dd. Standard deviation (ensemble). For an ensemble $\{x_i(t): 0 \leq t \leq T < \infty, i = 1, 2, \dots, N\}$ of N time history records with a mean, $\mu(t)$, and a standard deviation, $\sigma(t)$, $0 \leq t \leq T$, where the mean $\mu(t)$ is estimated by $\hat{m}(t)$, an unbiased estimate of the standard deviation of the ensemble at time t is given by:

$$\hat{s}(t) = \sqrt{\frac{1}{N-1} \sum_{i=1}^N (x_i(t) - \hat{m}(t))^2} \quad 0 \leq t \leq T$$

- ee. Stationary process. A stationary random process is an ensemble of time history records that has statistical properties that are not a function of time and, hence, are invariant with respect to time translations. The stationary random process may be ergodic or nonergodic.
- ff. Transient vibration. A form of nonstationary random vibration time history that has a positive time-varying envelope that begins at zero and ends at zero over a certain period of time, $T < \infty$. In general, for $a(t)$, $0 \leq t \leq T$, the time-varying deterministic envelope function with frequency content below significant frequency content in the stationary random vibration time history, $x(t)$, the transient vibration may be modeled in terms of the product model

$$y(t) = a(t)x(t) \quad 0 \leq t \leq T$$

A condition for application of this model to random data is

$$|A(f, T)| \ll |X(f, T)| \quad f_0 < f$$

for some f_0 and $f_0 < f$ where $f_0 \approx \frac{1}{T}$. This condition helps ensure $a(t)$ does not significantly modulate $x(t)$.

- gg. Variance (ensemble). For an ensemble $\{x_i(t): 0 \leq t \leq T < \infty, i = 1, 2, \dots, N\}$ of N time history records with a mean $\mu(t)$ and a variance $\sigma^2(t)$, $0 \leq t \leq T$, where $\mu(t)$ is estimated by $\hat{m}(t)$, an unbiased estimate of the variance of the ensemble at time t is given by:

$$\hat{v}(t) = \frac{1}{N-1} \sum_{i=1}^N (x_i(t) - \hat{m}(t))^2 \quad 0 \leq t \leq T$$

- hh. Waveform control. A form of vibration system control in which the system replicates a properly compensated time history, $x(t)$, in an open loop (no feedback) mode of control. In this standard, waveform control will refer to the replication of measured materiel response in laboratory testing based upon determining the input voltage time history to the vibration control system that will nearly exactly reproduce the measured materiel response when applied to the vibration system.

Subject Index (for Part One)

A

| | |
|---------------------------|---|
| Absolute humidity..... | C-3 |
| Accelerated test..... | 4 |
| Acceleration | vii, 15, 21, 23, A-9 |
| Aggravated test | 5 |
| Air circulation..... | 17 |
| Aircraft..... | 6, 13 |
| Alternatives..... | viii, 7, 10, A-3, B-2 |
| Ambient | 5, 15, 18, 19, A-7, A-13, C-2, C-3, C-6 |
| Atmospheric pressure..... | 15 |

B

| | |
|---------------------------|----|
| Baseline performance..... | 18 |
|---------------------------|----|

C

| | |
|--------------------------------|--|
| Calibration | 4, 16, A-7, A-12, A-16 |
| Catastrophic failure..... | C-4 |
| Climate..... | 5, 6, B-1, C-1, C-2, C-3 |
| Climatic categories..... | 5, A-12, C-2, C-3, C-4, C-5, C-6 |
| Coastal | C-2, C-3 |
| COEA | 2, 8, 9, 10 |
| Cold-wet | C-3 |
| Combat developer | 5, B-2, C-2 |
| Combined..... | 16, 19, 22, A-12, A-16, B-2, C-2, C-3, C-4 |
| Conditioning | 22, B-2 |
| Conduction..... | C-2 |
| Configuration | 17, A-5, A-12, A-16 |
| Contract requirements | 21 |
| Contractor | 9, 10, A-3, A-5, A-7, A-8, A-9, A-12 |
| Corrosion | C-3 |
| Critical threshold value | 5, A-16 |
| Cumulative effects | 5, 17 |

D

| | |
|--------------------------|------------|
| Daily cycles..... | C-3, C-6 |
| Damage | 18, 19, 20 |
| Dangerous materiel | C-4 |
| Data base..... | A-8, B-2 |
| Data requirements | 22, A-8 |
| Delivery..... | 14 |

MIL-STD-810F
1 January 2000
INDEX

| | |
|--|-------------------------------------|
| Deployment..... | 6, 8, 11, 14, A-6, C-4 |
| Design criteria | ii, 9 |
| Design engineers..... | 2, 7, 11, C-1 |
| Detailed Environmental Test Plan | 11, A-1, A-3, A-11 |
| DETP | iii, 2, 11, 21, A-1, A-3, A-11 |
| Development testing | B-2 |
| Deviation..... | 11, 15, 18, 19, 21, A-13, A-15, D-6 |
| DoD 5000-series | ii, 7, 10, B-1 |
| Dummy connectors | 17 |
| Durations..... | 1, 15, 17, 18, A-5, A-8 |

E

| | |
|--|---|
| EEMP | viii, 2, 9, 10, A-1, A-3, C-1 |
| EICL | viii, 9, 11, A-1, A-3, A-9 |
| Engineering judgement | ii, 5 |
| Environmental analysis | 2, 5 |
| Environmental class | C-1, C-2 |
| Environmental consideration | 1, 10, 23, B-1, B-2, C-1, C-4 |
| Environmental Engineering Management Plan..... | 7, 9, 10, A-1, A-3, C-1 |
| Environmental engineering specialists..... | ii, 1, 2, 7, 9, B-1, C-1 |
| Environmental engineering tasks | ii, 9, 10, A-3 |
| Environmental Issues/Criteria List..... | 11, A-1, A-3, A-7, A-9 |
| Environmental stress | ii, 1, 2, 4, 5, 11, 13, 18, 21, 23, A-5, A-7, A-11, B-2 |
| Environmental Test and Evaluation Master Plan..... | 9, 10, A-3, A-5, A-7, A-9 |
| Environmental Test Report | 11, 21, 23, A-1, A-3, A-15 |
| Environmental worthiness..... | ii, 5, A-16 |
| Established limits | ii, 21 |
| ETEMP | 9, 10, A-3, A-5, A-7, A-9 |
| ETR..... | viii, 2, 11, A-1, A-3, A-15 |
| Extreme conditions | C-4 |
| Extreme environment..... | B-1, C-3 |

F

| | |
|--------------------------------------|--------------------------------------|
| Facility operators | ii, 1, 2, 11, 12, 17, A-11, C-1 |
| Failure analyses..... | 11, 19, 22, A-13, A-15 |
| Failure criteria..... | 6, 21, A-12 |
| Failure modes..... | A-11 |
| Field/fleet verification trials..... | iii |
| Forcing functions | 2, 5, 6, 7, 8, 13, 14, 18, A-11, C-1 |
| Foreign..... | 1 |
| Forested | C-3 |
| Freezing point | C-3 |

H

| | |
|---------------|----------|
| Hot-dry..... | C-2, C-6 |
| Hot-wet | C-3 |

I

| | |
|------------------------------|--|
| Induced | 5, 6, 8, 10, 13, 23, A-5, B-1, B-2, C-1, C-4 |
| Instrumentation | 5, 11, 15, 16, 17, A-7, A-8, A-12, A-16 |
| Integrated Product Team..... | 5, 9 |
| International..... | 4, 23, 24, C-3 |
| Interrupted tests | 18, 20 |
| Invalid test | 19 |

K

| | |
|---------------------|-----|
| Knowledge base..... | C-2 |
|---------------------|-----|

L

| | |
|--|--|
| Laboratory standards..... | 16 |
| Laboratory testing | ii, viii, 2, 11, 12, B-2, D-6 |
| LCEP | viii, 2, 8, 9, 10, 11, 13, 14, A-1, A-3, A-5, A-6, A-9, C-1 |
| Levels..... | 1, 6, 8, 9, 11, 17, 18, 19, 21, 22, A-11, A-13, C-1, C-2, C-3, C-4, D-1, D-4 |
| Life Cycle Environmental Profile | ii, 8, 9, 10, A-1, A-3, A-5, A-7, B-2, C-1, C-4 |
| Life cycle sequence..... | 16 |
| Limitations | ii, 2, A-5, A-9 |
| Living document | iii, A-3, A-5 |
| Logistic supply | 13 |

M

| | |
|-------------------------|--|
| Materiel developer..... | ii, 1, 6, A-3, A-5, A-7, A-9, A-11, C-2, C-4 |
| Microbiological..... | C-3 |
| Military | 1, 3, 4, 5, 10, C-3, C-4, C-6 |
| Mission profile..... | 6, 13, 17, A-8, C-4 |
| MNS..... | 2, 8, 10, A-3, A-9 |
| Modification kits..... | B-1, C-4 |

N

| | |
|-----------------------------|---|
| Natural (field/fleet) | 9 |
| Natural environment | 5, 7, 8, 11, 12, 13, 17, 23, A-11, B-2, C-1 |
| Normal environment | C-3 |

O

| | |
|---|--|
| Objections | 19 |
| Obscurants | B-1, B-2 |
| OED | iii, 2, 9, 10, 11, A-1, A-3, A-7, A-8, A-9 |
| OEDP..... | 9, 10, 11, A-7, A-8 |
| OEDR | 11, A-7, A-8 |
| Operation | 5, 6, 7, 8, 17, 18, B-1, C-4 |
| Operational Environment Documentation Plan..... | 9, 10, A-7 |

MIL-STD-810F
1 January 2000
INDEX

| | |
|---|-------------------------|
| Operational Environment Documentation Report..... | 11, A-7, A-8 |
| Operational testing..... | B-2 |
| Operational worthiness | 6, 11, A-15 |
| ORD..... | 2, 8, 10, A-3, A-9, C-4 |
| Outdoor ambient | C-2, C-3 |
| Overtest..... | 18, 19, 20, D-1 |

P

| | |
|-----------------------------------|--|
| Performance data | 18, 19, A-13 |
| Platform environment | 6, 8, 9, A-7, C-1 |
| Post test..... | 18, 19, A-11, A-12, A-13 |
| Pretest | 17, 18, 19, 21, A-11, A-12, A-13 |
| Primary | ii, 7, 9, 10, 11, 16 |
| Program Management Guidance | B-1 |
| Program manager..... | ii, 1, 2, 6, 7, 8, 9, 10, A-3, B-2, C-1, C-2 |

R

| | |
|------------------------------|--------------------------|
| Radiation..... | C-2 |
| Rationale..... | ii, iii, 7, 11, A-9, B-2 |
| Realistic test..... | 17 |
| Real-world | ii, 7, A-5 |
| Relative humidity..... | 15, C-2, C-3, C-6 |
| Requirements documents | 3, 8, 10, C-4 |
| RF interfaces..... | 17 |

S

| | |
|------------------------------------|--|
| Safety | 2, 3, 7, 15, 20, 21, A-3, A-12, B-1, B-2, C-2, C-4 |
| Saturation..... | C-3, C-6 |
| SEMP..... | 9, 10, A-3 |
| Service conditions..... | ii, A-8 |
| Service life | ii, 1, 5, 6, 8, 11, 21, A-5, B-1, C-1 |
| Service-specific..... | ii |
| Severe cold | C-2, C-3, C-4, C-5, C-6 |
| Sheltered materiel..... | 13, C-4 |
| Shipping..... | 6, 13 |
| Ships..... | 13 |
| Shock | 1, 4, 21, 23, B-1, B-2, C-2, C-4, D-6 |
| Shock/vibration..... | B-2, C-2 |
| Simulation | viii, 7, 9, 10, A-3, B-2 |
| Smoke/obscurants | B-2 |
| Solar radiation..... | 23, B-1, C-3, C-6 |
| Soldier/system interface..... | C-4 |
| Specifications and Standards | 3 |
| Specified value..... | 15, 16 |
| Standardization | iii, 4, 18, 23, C-6 |
| STAR | 2, 8 |
| Storage | 5, 6, 7, 8, 10, 13, A-12, B-1, B-2, C-2, C-4 |
| Stores | 6, 14 |

| | |
|----------------------------|------------------------------|
| Synergetic | 16 |
| Synergistic | 2, 21, 22, B-2 |
| System assessment | B-2, C-2 |
| System effectiveness | 7, A-3, A-11, A-16, B-1, B-2 |

T

| | |
|---|--|
| Tailoring | ii, viii, 1, 2, 6, 7, 8, 9, 10, 11, 12, 17, 23, A-11, B-1, B-2, C-1, C-2 |
| Technical manuals | C-4 |
| TEMP | 2, 8, 9, 10, A-3, A-9 |
| Temperature gradient..... | 15 |
| Temperature limits | 16 |
| Terrain | 7, B-1, C-1, C-3 |
| Test chamber..... | 17, 22 |
| Test criteria | 4, 5, 7, 9, 10, 11, A-7, A-9, A-12, C-1, C-6 |
| Test duration | 15, 17, 18, A-12, A-16 |
| Test engineer..... | ii, 2, 7, 11, 12, 19, A-13, C-1 |
| Test Engineer and Facility Operators..... | 11 |
| Test facilities..... | ii, 17, A-12 |
| Test level..... | 6, 17, 18, D-4 |
| Thermal effects | C-2 |
| Threat environmental factors | 9 |
| Tolerances..... | 6, 15, 18, 22, A-12 |
| Transit..... | 5, 10, B-1, B-2, C-2, C-4 |
| Transport..... | 7, 8, 13, A-5, C-4 |
| Tundra..... | C-3 |
| Turbulence | C-2 |

U

| | |
|------------------|-----------------|
| Undertest..... | 18, 19, 20, D-1 |
| User needs | ii, 1 |

V

| | |
|------------------------------|--|
| Verification sensors | 15 |
| Vibration..... | 1, 4, 8, 15, 16, 21, 23, A-13, B-1, B-2, C-1, C-2, C-4, D-1, D-4, D-5, D-6 |
| Virtual proving ground | 7, 9, C-2 |

W

| | |
|------------|----------|
| Wind | B-1, C-2 |
|------------|----------|

MIL-STD-810F
1 January 2000
PART TWO

PART TWO -- LABORATORY TEST METHODS

| | | |
|-----|--|---------------------|
| 500 | Low Pressure (Altitude) | 500.4-1 – 500.4-8 |
| 501 | High Temperature | 501.4-1 – 501.4-12 |
| 502 | Low Temperature | 502.4-1 – 502.4-10 |
| 503 | Temperature Shock | 503.4-1 – 503.4-10 |
| 504 | Contamination by Fluids | 504-1 – 504A-2 |
| 505 | Solar Radiation (Sunshine) | 505.4-1 – 505.4A-8 |
| 506 | Rain | 506.4-1 – 506.4-12 |
| 507 | Humidity | 507.4-1 – 507.4A-2 |
| 508 | Fungus | 508.5-1 – 508.5-12 |
| 509 | Salt Fog | 509.4-1 – 509.4-10 |
| 510 | Sand and Dust | 510.4-1 – 510.4-14 |
| 511 | Explosive Atmosphere | 511.4-1 – 511.4-6 |
| 512 | Immersion | 512.4-1 – 512.4-8 |
| 513 | Acceleration | 513.5-1 – 513.5-14 |
| 514 | Vibration | 514.5-i – 514.5C-16 |
| 515 | Acoustic Noise | 515.5-i – 515.5B-2 |
| 516 | Shock | 516.5-i – 516.5C-4 |
| 517 | Pyroshock | 517-1 – 517-24 |
| 518 | Acidic Atmosphere | 518-1 – 518-6 |
| 519 | Gunfire Vibration | 519.5-i – 519.5D-10 |
| 520 | Temperature, Humidity, Vibration, and Altitude | 520.2-1 – 520.2A-10 |
| 521 | Icing/Freezing Rain | 521.2-1 – 521.2-8 |
| 522 | Ballistic Shock | 522-1 – 522-14 |
| 523 | Vibro-Acoustic/Temperature | 523.2-1 – 523.2A-8 |

METHOD 500.4

LOW PRESSURE (ALTITUDE)

NOTE: Tailoring is essential. Select methods, procedures and parameter levels based on the tailoring process described in Part One, paragraph 4.2.2, and Appendix C. Apply the general guidelines for laboratory test methods described in Part One, paragraph 5 of this standard.

1. SCOPE.

1.1 Purpose.

Use low pressure (altitude) tests to determine if materiel can withstand and/or operate in a low pressure environment and/or withstand rapid pressure changes.

1.2 Application.

Use this method to evaluate materiel likely to be:

- a. stored and/or operated at high ground elevation sites.
- b. transported or operated in pressurized or unpressurized areas of aircraft (consider also method 520.2).
- c. exposed to a rapid or explosive decompression and, if so, to determine if its failure will damage the aircraft or present a hazard to personnel.
- d. carried externally on aircraft.

1.3 Limitations.

This method is not intended to be used to test materiel to be installed or operated in space vehicles, aircraft or missiles that fly at altitudes above 30,000m.

2. TAILORING GUIDANCE.

2.1 Selecting the Low Pressure (Altitude) Method.

After examining the requirements documents and applying the tailoring process in Part One of this standard to determine where low pressure is foreseen in the life cycle of the materiel, use the following to aid in selecting this method and placing it in sequence with other methods.

2.1.1 Effects of low pressure environments.

In addition to thermal effects (see method 501.4), consider the following typical problems to help determine if this method is appropriate for the materiel being tested. This list is not intended to be all-inclusive and some of the examples may overlap the categories.

2.1.1.1 Physical/chemical.

- a. Leakage of gases or fluids from gasket-sealed enclosures.
- b. Deformation, rupture or explosion of sealed containers.
- c. Change in physical and chemical properties of low-density materials.
- d. Overheating of materiel due to reduced heat transfer.

MIL-STD-810F
1 January 2000

- e. Evaporation of lubricants.
- f. Erratic starting and operation of engines.
- g. Failure of hermetic seals.

2.1.1.2 Electrical.

Erratic operation or malfunction of materiel resulting from arcing or corona.

2.1.2 Sequence among other methods.

- a. General. See Part One, paragraph 5.5.
- b. Unique to this method. Normally this method is performed early in a test sequence because of both its limited damage potential and its generally early occurrence in the life cycle. However, other testing may contribute significantly to the effects of low pressure on the test item (see paragraph 2.1.1), and may have to be conducted before this method. For example:
 - c. Low-temperature and high-temperature testing may affect seals.
 - d. Dynamic tests may affect the structural integrity of the test item.
 - e. Aging of non-metallic components may reduce their strength.

2.2 Selecting Procedures.

This method includes four low pressure tests: Procedure I (Storage); Procedure II (Operation); Procedure III (Rapid Decompression), and Procedure IV (Explosive Decompression). Based on the test data requirements, determine which of the test procedures or combination of procedures is applicable.

2.2.1 Procedure selection considerations.

Differences among the low pressure test procedures are explained below. Select the procedure that represents the most severe exposure anticipated. When selecting a procedure, consider:

- a. The materiel configuration.
- b. The logistical and operational requirements (purpose) of the materiel.
- c. The operational purpose of the materiel.
- d. The test data required to determine if the operational purpose of the materiel has been met.
- e. Procedure sequence.

2.2.2 Difference among procedures.

- a. Procedure I - Storage/Air Transport. Procedure I is appropriate if the materiel is to be transported or stored at high ground elevations or transported by air in its shipping/storage configuration. Evaluate the materiel with respect to known effects of low pressure (paragraph 2.1.1) and the LCEP (Part One, paragraph 4.2.2.3.1) to determine if this procedure is appropriate.
- b. Procedure II - Operation/Air Carriage. Use Procedure II to determine the performance of the materiel under low pressure conditions. It may be preceded by Procedure I. If there are no low pressure storage, rapid or explosive decompression requirements, this procedure can stand alone.
- c. Procedure III - Rapid Decompression. Use Procedure III to determine if a rapid decrease in pressure of the surrounding environment will cause a materiel reaction that would endanger nearby personnel or the platform (ground vehicle or aircraft) in which it is being transported. This procedure may be preceded by either the storage or the operational test.

- d. Procedure IV - Explosive Decompression. Procedure IV is similar to Procedure III except that it involves an "instantaneous" decrease in the pressure of the surrounding environment.

NOTE: After either decompression test a potential safety problem could exist that is not obvious. Exercise caution during the post-test operational check.

2.3 Determine Test Levels and Conditions.

Having selected this method and relevant procedures (based on the materiel's requirements documents and the tailoring process), it is necessary to complete the tailoring process by selecting specific parameter levels and special test conditions/techniques for these procedures based on requirements documents, Life Cycle Environmental Profile, Operational Environment Documentation (see Part One, figure 1-1), and information provided with this procedure. From these sources of information, determine the functions to be performed by the materiel in low pressure environments or following storage in low pressure environments. Determine the test parameters such as test pressure and temperature, rate of change of pressure (and temperature if appropriate), duration of exposure, and test item configuration.

2.3.1 Test pressure and temperature.

Base determination of the specific test pressures and temperatures on the anticipated deployment or flight profile of the test item.

- a. Ground areas. If measured data are not available, temperatures may be obtained for appropriate ground elevations and geographical locations from STANAG 2895. The highest elevation currently contemplated for NATO ground military operations (materiel operating and nonoperating) is 4,570m with an equivalent air pressure of 57 kPa.
- b. Transport aircraft cargo compartment pressure conditions. The test pressure used for each of the four procedures in this method will vary greatly for each test item. There are many different types of cargo transport aircraft on which materiel could be transported and many different types of pressurization systems. Aircraft have different service ceilings ("normal" altitude for cruise) and the normal service ceiling may not be achievable for very heavy equipment. Most pressurization systems provide outside atmospheric pressure in the cargo compartment (no pressure differential between the inside and outside of the aircraft) up to a particular altitude, and then maintain a specific pressure above that altitude. The pressure inside the cargo department is known as "cabin altitude." Subject the test item to the most likely anticipated conditions. Unless the materiel has been designed for transport on a particular aircraft with unique cabin altitude requirements, use the following guidance:
 - (1) For Procedures I and II, use 4,572m (15,000 ft) for the cabin altitude (corresponding pressure in a standard atmosphere: 57.2kPa or 8.3 psia).
 - (2) For Procedures III and IV, use 2,438m (8,000 ft) for the initial cabin altitude (75.2kPa or 10.9 psia), and 12,192m (40,000 ft) for the final cabin altitude after decompression (18.8kPa or 2.73 psia).
- c. Transport aircraft cargo compartment temperature conditions. The range of temperatures associated with the various low pressure situations varies widely, primarily depending on the capabilities of the environmental control system within the cargo compartment of the various aircraft. Obtain the test temperatures from measured data or from appropriate national sources.

2.3.2 Altitude change rate.

If a specific rate of altitude change (climb/descent rate) is not known or specified in the requirements document, the following guidance is offered: In general, and with the exception of the explosive decompression test, do not use a rate of altitude change that exceeds 10 m/s unless justified by the anticipated deployment platform. In a full military power takeoff, military transport aircraft normally have an average altitude change rate of 7.6 m/s. Use the value of 10 m/s for ground deployment tests (for standardization purposes) unless otherwise specified.

MIL-STD-810F
1 January 2000

2.3.3 Decompression rate.

There are several conditions for which the rapid rate of decompression may vary. These include:

- a. massive damage to the aircraft, but the aircraft survives and decompression is virtually instantaneous (explosive decompression -- to be accomplished in 0.1 second or less).
- b. relatively minor damage caused by foreign objects through which decompression could occur at a slower rate than above (rapid decompression -- not more than 15 seconds).

2.3.4 Test duration.

For Procedure I, use a test duration representative of the anticipated service environment but, if this is extensive, use a test duration of at least one hour which is considered adequate for most materiel. Once the test pressure has been reached and any required functions performed, Procedures II, III, and IV do not require extended periods at the test pressure.

2.3.5 Test item configuration.

Determine the test item configuration based on the realistic configuration(s) of the materiel as anticipated for transportation, storage, or operation. As a minimum, consider the following configurations:

- a. In a shipping/storage container or transit case.
- b. In its normal operating configuration (realistic or with restraints, such as with openings that are normally covered).

2.3.6 Humidity.

Although various levels of humidity commonly exist in the natural environment, there is no requirement to include it in this method because of the complexities involved in controlling combinations of temperature, air pressure, and relative humidity. Method 520.2 does include this combination, and MIL-HDBK-310 includes data on humidity at altitude.

3. INFORMATION REQUIRED.

3.1 Pretest.

- a. General. Information listed in Part One, paragraphs 5.7 and 5.9, and Appendix A, Task 405 of this standard.
- b. Specific to this method.
 - (1) Test altitude and corresponding pressure.
 - (2) Altitude change rates (or pressurization schedule if a particular aircraft and flight environment are known).
 - (3) Test temperature (if other than standard ambient).
 - (4) Test item configuration.
 - (5) Test duration.

3.2 During test.

See Part One, paragraph 5.10, and Appendix A, Task 406 of this standard.

3.3 Post-test.

- a. General. Information listed in Part One, paragraph 5.13, and in Appendix A, Task 406 of this standard.
- b. Specific to this method.
 - (1) Previous test methods to which the specific test item has been subjected.

- (2) Time-versus pressure data.

4. TEST PROCESS.

4.1 Test Facility.

- a. The required apparatus consists of a chamber or cabinet together with auxiliary instrumentation capable of maintaining and monitoring (see Part One, paragraph 5.18) the required conditions of low pressure and temperature.
- b. Make continuous recordings of chamber pressure and, if required, temperature.

4.2 Controls.

- a. Altitude change rate. For standardization purposes, and unless otherwise specified, do not use an altitude change rate in excess of 10 m/s. (See paragraph 2.3.2.)
- b. Charts. For standardization purposes, use readout charts that can be read with a resolution within two percent of full scale.

4.3 Test Interruption.

- a. General. See Part One, paragraph 5.11, of this standard.
- b. Specific to this method. To achieve the desired effects, subject the test item to the full duration of the low pressure test without interruption.

4.4 Test Setup.

See Part One, paragraph 5.8.

4.5 Test Execution.

The following steps, alone or in combination, provide the basis for collecting necessary information concerning the materiel in a low pressure environment. Unless otherwise specified, maintain the chamber temperature at standard ambient.

4.5.1 Preparation for test.

4.5.1.1 Preliminary steps.

Before starting the test, review pretest information in the test plan to determine test details (e.g., procedures, test item configuration, test altitude, altitude change rate, duration, parameter levels for storage/operation, etc.).

4.5.1.2 Pretest standard ambient checkout.

All test items require a pretest standard ambient checkout to provide baseline data. Conduct the checkout as follows:

- Step 1. If required, install temperature sensors in or on the test item as described in the test plan.
- Step 2. Install the test item in the chamber (Part One, paragraph 5.8.1) at standard ambient conditions (Part One, paragraph 5.1).
- Step 3. Conduct a visual examination of the test item with special attention to stress areas, such as corners of molded cases, and document the results.
- Step 4. Conduct an operational checkout (Part One, paragraph 5.8.2) as described in the plan and record the results.
- Step 5. If the test item operates satisfactorily, proceed to the appropriate test procedure. If not, resolve the problems and repeat Step 4 above.

4.5.2 Procedure I - Storage/Air Transport.

- Step 1. Place the test item in its storage or transport configuration and install it in the test chamber.

MIL-STD-810F
1 January 2000

- Step 2. If appropriate, stabilize the test item to the required temperature.
- Step 3. Adjust the chamber air pressure to that which corresponds to the required test altitude, at an altitude change rate as specified in the test plan.
- Step 4. Maintain the conditions for a minimum of one hour unless otherwise specified in the test plan.
- Step 5. Adjust the chamber air to standard ambient conditions at the rate specified in the test plan.
- Step 6. Visually examine the test item to the extent possible and conduct an operational check. Document the results.

4.5.3 Procedure II - Operation/Air Carriage.

- Step 1. With the test item in its operational configuration, adjust the chamber air pressure (and temperature, if appropriate) to that which corresponds to the required operational altitude at a rate not to exceed that specified in the test plan.
- Step 2. Conduct an operational check of the test item in accordance with the requirements documents, and document the results.
- Step 3. Adjust the chamber air to standard ambient conditions at the rate specified in the test plan.
- Step 4. Visually examine the test item to the extent possible and conduct an operational check. Document the results.

4.5.4 Procedure III - Rapid Decompression.

- Step 1. With the test item in the storage or transit configuration, adjust the chamber air pressure (and temperature if appropriate) at the rate specified in the test plan to the cabin altitude (2,438m) (see paragraph 2.3.1b).
- Step 2. Reduce the chamber air pressure to that which corresponds to the required test altitude of 12,192m (18.8 kPa), or as otherwise specified in the test plan for the maximum flight altitude, in not more than 15 seconds. Maintain this stabilized reduced pressure for at least 10 minutes.
- Step 3. Adjust the chamber air to standard ambient conditions at the rate specified in the test plan.
- Step 4. Visually examine the test item to the extent possible. Document the results. Note: Be alert for potential safety problems.

4.5.5 Procedure IV - Explosive Decompression.

- Step 1. With the test item in the storage or transit configuration, adjust the chamber air pressure (and temperature if appropriate) at the rate specified in the test plan to the cabin altitude (2,438m) (see paragraph 2.3.1b).
- Step 2. Reduce the chamber air pressure to that which corresponds to the required test altitude of 12,192m or as otherwise specified in the test program, in not more than 0.1 seconds. Maintain this stabilized reduced pressure for at least 10 minutes.
- Step 3. Adjust the chamber air to standard ambient conditions at the rate specified in the test plan.
- Step 4. Visually examine the test item to the extent possible. Document the results. Note: Be alert for potential safety problems.

5. ANALYSIS OF RESULTS.

In addition to the guidance provided in Part One, paragraph 5.14, the following information may assist in the evaluation of the test results. Apply any data relative to failure of a test item to meet the requirements of the materiel specifications to the test analysis. For Procedures III and IV, the test item fails only if rapid or explosive decompression causes a hazard to the aircraft or to personnel; the test item need not show satisfactory post-test performance unless otherwise specified.

6. REFERENCE/RELATED DOCUMENTS.

- a. STANAG 4044, Adoption of a Standard Atmosphere, 10 April 1969, (ICAO Standard Atmosphere).
- b. STANAG 4370, Environmental Testing.
- c. Allied Environmental Conditions and Test Publication 300, Climatic Environmental Testing (Edition 2) (under STANAG 4370).

MIL-STD-810F
1 January 2000

- d. MIL-HDBK-310, Global Climatic Data for Developing Military Products.
- e. Synopsis of Background Material for MIL-STD-210B, Climatic Extremes for Military Equipment. Bedford, MA. U.S. Air Force Cambridge Research Laboratories, 1974. DTIC number AD-780-508.
- f. Handbook of Geophysics and Space Environments. Bedford, MA. U.S. Air Force Cambridge Research Laboratories, Office of Aerospace Research, 1965.
- g. U.S. Standard Atmosphere, 1976. NOAA/NASA/USAF, 1976.

MIL-STD-810F
1 January 2000

THIS PAGE INTENTIONALLY BLANK

METHOD 501.4

HIGH TEMPERATURE

NOTE: Tailoring is essential. Select methods, procedures, and parameter levels based on the tailoring process described in Part One, paragraph 4.2.2, and Appendix C. Apply the general guidelines for laboratory test methods described in Part One, paragraph 5 of this standard.

1. SCOPE.

1.1 Purpose.

Use high temperature tests to obtain data to help evaluate effects of high temperature conditions on materiel safety, integrity, and performance.

1.2 Application.

Use this method to evaluate materiel likely to be deployed in areas where temperatures are higher than standard ambient.

1.3 Limitations.

Limit use of this method to evaluating the effects of relatively short-term (months, as opposed to years), even distributions of heat throughout the test item. This method is not generally practical for:

- a. Evaluating time-dependent performance degradation (aging) effects that occur during constant long-term exposure to high temperatures (under storage or operational modes) where synergetic effects may be involved. For such high temperature aging effects, test in the natural environment.
- b. Evaluating materiel in a high temperature environment where solar radiation produces significant thermal gradients in the materiel. For simulating direct solar impingement, use method 505.4, Procedure I.
- c. Evaluating actinic (photochemical) effects (for the last part use method 505.4, Procedure II).
- d. Evaluating the effects of aerodynamic heating.

2. TAILORING GUIDANCE.

2.1 Selecting this Method.

After examining requirements documents and applying the tailoring process in Part One of this standard to determine where high temperatures are foreseen in the life cycle of the test item, use the following to confirm the need for this method and to place it in sequence with other methods.

2.1.1 Effects of high temperature environments.

High temperatures may temporarily or permanently impair performance of materiel by changing physical properties or dimensions of the material(s) of which it is composed. The following are examples of problems that could result from high temperature exposure that may relate to the materiel being tested. Consider the following typical problems to help determine if this method is appropriate for the materiel being tested. This list is not intended to be all-inclusive.

- a. Parts bind from differential expansion of dissimilar materials.
- b. Lubricants become less viscous; joints lose lubrication by outward flow of lubricants.
- c. Materials change in dimension, either totally or selectively.

MIL-STD-810F
1 January 2000

- d. Packing, gaskets, seals, bearings and shafts become distorted, bind, and fail causing mechanical or integrity failures.
- e. Gaskets display permanent set.
- f. Closure and sealing strips deteriorate.
- g. Fixed-resistance resistors change in values.
- h. Electronic circuit stability varies with differences in temperature gradients and differential expansion of dissimilar materials.
- i. Transformers and electromechanical components overheat.
- j. Operating/release margins of relays and magnetic or thermally activated devices alter.
- k. Shortened operating lifetime.
- l. Solid pellets or grains separate.
- m. High pressures created within sealed cases (projectiles, bombs, etc.).
- n. Accelerated burning of explosives or propellants.
- o. Expansion of cast explosives within their cases.
- p. Explosives melt and exude.
- q. Discoloration, cracking or crazing of organic materials.
- r. Outgassing of composite materials.

2.1.2 Sequence among other methods.

- a. General. See Part One, paragraph 5.5.
- b. Unique to this method. There are at least two philosophies related to test sequence. One approach is to conserve test item life by applying what are perceived to be the least damaging environments first. For this approach, generally apply the high temperature test early in the test sequence. Another approach is to apply environments to maximize the likelihood of disclosing synergetic effects. For this approach, consider high temperature testing following dynamic tests, such as vibration and shock. Although not written for such, this test may be used in conjunction with shock and vibration tests to evaluate the effect of dynamic events (i.e., shipping, handling, and shock) on hot materials. Also, this test may contribute significantly to the results of low pressure testing of seals, e.g., see paragraph 2.1.1d, e and f.

2.2 Selecting Procedures.

This method includes two test procedures, Procedure I (Storage) and Procedure II (Operation). Determine the procedure(s) to be used.

2.2.1 Procedure selection considerations.

When selecting procedures, consider:

- a. The operational purpose of the materiel.
- b. The natural exposure circumstances.
- c. The test data required to determine whether the operational purpose of the materiel has been met.
- d. Procedure sequence. If both the storage and operation procedures are to be applied, perform Procedure I before Procedure II.

- e. Other significant heat sources that could affect the materiel such as motors, engines, power supplies, or exhaust air.

2.2.2 Difference between procedures.

While both procedures involve temperature conditioning and performance testing, they differ on the basis of the temperature load prior to and during performance tests. The storage procedure assesses the effects of high temperature storage on subsequent materiel performance. The operation procedure assesses the effects of high temperatures during performance.

- a. Procedure I - Storage. Use Procedure I to investigate how high temperatures during storage affect the materiel (integrity of materials, and safety/performance of the materiel). This test procedure includes exposing the test item to high temperatures (and low humidity where applicable) that may be encountered in the materiel's storage situation, followed by a performance test at standard or high temperature ambient conditions.
- b. Procedure II - Operation. Use Procedure II to investigate how high ambient temperatures may affect materiel performance while it is operating. There are two ways to perform Procedure II:
 - (1) Expose the test item to cyclic chamber conditions with the test item operating either continuously or during the period of maximum response (highest item temperature).
 - (2) Expose the test item to a constant temperature and operate the test item when its temperature stabilizes.

2.3 Determine Test Levels and Conditions.

Having selected this method and relevant procedures (based on the test item's requirements documents and the tailoring process), complete the tailoring process by identifying appropriate parameter levels and applicable test conditions and techniques for these procedures. Base these selections on the requirements documents, the Life Cycle Environmental Profile, Operational Environment Documentation (see Part One, figure 1-1), and information provided with this procedure. Consider the following when selecting test levels.

2.3.1 Climatic conditions.

Identify the appropriate climatic conditions for the geographic areas in which the materiel will be operated and stored. There are two climatic categories where high temperatures are typically encountered: Hot Dry and Basic Hot (Part One, Appendix C, figure C-1). Data for these areas are shown in tables 501.4-I, -II, and -III. Determine high temperature levels with respect to:

- a. Climatic area of concern.
- b. Exposure to solar radiation: Is this exposure directly on the materiel, shipping container, protective package shelter, etc.?
- c. Analysis of the path of heat transfer from the ambient air and solar radiation to the materiel.

2.3.2 Exposure conditions.

Before determining the levels at which to set test temperatures, determine the way in which the materiel is exposed to heat in normal storage and operational circumstances. Review the LCEP to help make this determination. Consider at least the following exposure conditions:

- a. Deployment configuration.
 - (1) Exposed. Of interest are the most severe conditions that materiel would experience when deployed in any climatic area of the world without the benefit of a protective cover or sheltering enclosure.
 - (2) Sheltered. Of interest are the most severe conditions that materiel would experience when deployed in any climatic area of the world when under cover or inside a sheltering enclosure. The amount of ventilation available and the presence of adjacent shade can significantly affect the temperature of the air surrounding sheltered materiel. Examples of these situations are provided below. (Note: If

MIL-STD-810F
1 January 2000

field data are not available, the conditions for this exposure may be approximated using MIL-HDBK-310 or NATO STANAG 2895. The outdoor ambient air temperature and humidity conditions described in this reference are those measured in standard meteorological shelters at a height of 1.2 to 1.8 m (4 to 6 ft) above the ground.)

- (a) Inside unventilated enclosures.
 - (b) Within enclosed vehicle bodies.
 - (c) Within aircraft sections having surfaces exposed to solar heating.
 - (d) Inside of tents.
 - (e) Under closed tarpaulins.
 - (f) Located above, on, or below the surface of the Earth.
- b. Exposure duration. Determine the duration of exposure that the materiel will experience for each of the exposure conditions identified. Exposure may be constant or cyclic, in which case, also identify the number of times that the exposure occurs.
- c. Special conditions. Although high temperature testing is generally based on the average temperature of the air envelope surrounding the materiel, significant localized heating can occur because of special heating conditions. This localized heating can be well above the average surrounding air and therefore can significantly affect the evaluation of the materiel's thermal behavior and performance. When these conditions exist (as described below), include or simulate them in the high temperature test setup to the extent practical.
- (1) Aggravated solar. When materiel is located behind glazed or transparent panels or within confined, unventilated compartments behind thin metallic skins, direct solar impingement may temporarily raise local air temperatures in excess of those shown in tables 505.4-I and -II. Use caution when applying extreme temperatures because of increased damage potential. In these circumstances base testing on actual field measurements. (Applicable conditions for such testing may indicate using method 505.4 separately or in conjunction with this method.)
 - (2) Man-made sources. Man-made heat-producing devices (motors, engines, power supplies, high-density electronic packages, etc.) may significantly raise the local air temperature near the materiel, either by radiation, convection, or impingement of exhaust air.

2.3.3 Test duration.

For constant temperature exposure, soak the test item until its temperature has stabilized and maintain the test temperature at least two hours following stabilization. For cyclic exposure, determine the test duration based on an estimate of the number of cycles required to satisfy the design requirements and the guidance below. The duration of high temperature exposure may be as significant as the temperature itself. Because Procedures I and II could expose the test items to cyclic temperatures, the number of cycles is critical. (Cycles are 24-hour periods unless otherwise specified.)

- a. Procedure I - Storage. The number of cycles for the storage test is set at a minimum of seven to coincide with the one percent frequency of occurrence of the hours of extreme temperatures during the most severe month in an average year at the most severe location. (The maximum temperature occurs for approximately one hour in each cycle.) When considering extended storage, critical materials, or materials determined to be very sensitive to high temperature, increase the number of cycles to assure the design requirements are met.
- b. Procedure II - Operation. The minimum number of cycles for the operational exposure test is three. This number is normally sufficient for the test item to reach its maximum response temperature. A maximum of seven cycles is suggested when repeated temperature response is difficult to obtain.

NOTE: This maximum response temperature is referenced in several other methods of this standard such as method 503.4.

2.3.4 Test item configuration.

Determine the test item configuration based on realistic configuration(s) of the materiel anticipated for storage and operation. As a minimum, consider the following configurations:

- a. In a shipping/storage container or transit case.
- b. Protected or unprotected (under canopy, enclosed, etc.).
- c. In its normal operating configuration (realistic or with restraints, such as with openings that are normally covered).
- d. Modified with kits for special applications.
- e. Stacked or palletized configurations.

2.3.5 Humidity.

Generally, relative humidity (RH) control during high temperature tests is not necessary. In special cases, extremely low RH may have a significant effect on some materiel during high temperature testing. If the materiel has special characteristics that could be affected by extremely low RH, use the values for RH shown in tables 501.4-I and -II.

2.4 Test Item Operation.

When it is necessary to operate the test item, use the following guidelines for establishing test operating procedures.

- a. General. See Part One, paragraph 5.8.2.
- b. Unique to this method.
 - (1) Include operating modes that consume the most power (generate the most heat).
 - (2) Include the required range of input voltage conditions if changes in voltage could affect the test item thermal dissipation or response (e.g., power generation or fan speed).
 - (3) Introduce the cooling media that normally would be applied during service use (e.g., forced air or liquid coolant). Consider using cooling medium inlet temperatures and flow rates that represent both typical and worst-case degraded temperature and flow conditions.
 - (4) For steady-state temperature testing, consider thermal stabilization to be achieved when the temperatures of critical internal operating components are relatively constant. (Because of test item duty cycling or the operating characteristics, a constant operating temperature may never be achieved.)
 - (5) For cyclic temperature testing and depending on the cycle and test item characteristics, there may be no thermal stabilization. In this case, the thermal responses of the test item will also be cyclic, i.e., the peak response temperature is within 2°C of that of the previous cycle.

3. INFORMATION REQUIRED.

3.1 Pretest.

The following information is required to conduct high temperature tests adequately.

- a. General. Information listed in Part One, paragraphs 5.7 and 5.9, and Appendix A, Task 405 of this standard.
- b. Specific to this method. Relative humidity control requirements (if necessary). (See paragraph 2.3.5 of this method.)
- c. Thermocouple locations. The component/assembly/structure to be used for thermal response and temperature stabilization purposes. (See Part One, paragraph 5.4.)

MIL-STD-810F
1 January 2000

3.2 During Test.

Collect the following information during conduct of the test:

- a. General. Information listed in Part One, paragraph 5.10, and in Appendix A, Task 406 of this standard.
- b. Specific to this method.
 - (1) Record of chamber temperatures (and humidity, if applicable) versus time conditions.
 - (2) Record of the test item temperature-versus-time data for the duration of the test.

3.3 Post-test.

See Part One, paragraph 5.13.

4. TEST PROCESS.

4.1 Test Facility.

- a. The required apparatus consists of a chamber or cabinet together with auxiliary instrumentation capable of maintaining and monitoring (see Part One, paragraph 5.18) the required conditions of high temperature (and humidity, where required) throughout an envelope of air surrounding the test item(s).
- b. Unless justified by the materiel platform environment and to prevent unrealistic heat transfer in the materiel, maintain the air velocity in the vicinity of the test item so as to not exceed 1.7 m/s (335 ft/min).
- c. Make continuous recordings of chamber temperature measurements and, if required, test item temperatures.

4.2 Controls.

- a. Temperature. Unless otherwise specified in the test plan, if any action other than test item operation (such as opening the chamber door) results in a significant change of the test item temperature (more than 2°C (3.6°F)) or chamber air temperature, re-stabilize the test item at the required temperature before continuing the test. If the operational check is not completed within 15 minutes, reestablish test item temperature/RH conditions before continuing.
- b. Rate of temperature change. Unless otherwise specified, use a rate of temperature change not exceeding 3°C (6°F) per minute to prevent thermal shock.

TABLE 501.4-I. High temperature cycles, climatic category - Basic Hot.^{1/}

| Time of Day | Ambient Air Conditions | | Induced Conditions | |
|-------------|--------------------------------------|--------------------------------|--------------------------------------|--------------------------------|
| | Temperature ^{3/} °C (°F) | Humidity ^{2/} % RH | Temperature ^{3/} °C (°F) | Humidity ^{2/} % RH |
| 0100 | 33 (91) | 36 | 33 (91) | 36 |
| 0200 | 32 (90) | 38 | 32 (90) | 38 |
| 0300 | 32 (90) | 41 | 32 (90) | 41 |
| 0400 | 31 (88) | 44 | 31 (88) | 44 |
| 0500 | 30 (86) | 44 | 30 (86) | 44 |
| 0600 | 30 (86) | 44 | 31 (88) | 43 |
| 0700 | 31 (88) | 41 | 34 (93) | 32 |
| 0800 | 34 (93) | 34 | 38 (101) | 30 |
| 0900 | 37 (99) | 29 | 42 (107) | 23 |
| 1000 | 39 (102) | 24 | 45 (113) | 17 |
| 1100 | 41 (106) | 21 | 51 (124) | 14 |
| 1200 | 42 (107) | 18 | 57 (134) | 8 |
| 1300 | 43 (109) | 16 | 61 (142) | 6 |
| 1400 | 43 (110) | 15 | 63 (145) | 6 |
| 1500 | 43 (110) | 14 | 63 (145) | 5 |
| 1600 | 43 (110) | 14 | 62 (144) | 6 |
| 1700 | 43 (109) | 14 | 60 (140) | 6 |
| 1800 | 42 (107) | 15 | 57 (134) | 6 |
| 1900 | 40 (104) | 17 | 50 (122) | 10 |
| 2000 | 38 (100) | 20 | 44 (111) | 14 |
| 2100 | 36 (97) | 22 | 38 (101) | 19 |
| 2200 | 35 (95) | 25 | 35 (95) | 25 |
| 2300 | 34 (93) | 28 | 34 (93) | 28 |
| 2400 | 33 (91) | 33 | 33 (91) | 33 |

^{1/} These cycles were obtained from AR 70-38, 1 August 1979, and essentially conform to those in MIL-HDBK-310 and NATO STANAG 2895. These values represent typical conditions throughout a typical day in this climatic category. "Induced Conditions" are air temperature levels to which materiel may be exposed during storage or transit situations that are aggravated by solar loading.

^{2/} Humidity control during high temperature testing is generally not necessary. Use these values only in special cases.

^{3/} Data were originally recorded in °F and converted to °C. Hence, table data conversion may not be consistent.

MIL-STD-810F
1 January 2000

TABLE 501.4-II. High temperature cycles, climatic category - Hot.^{1/}

| Time of Day | Ambient Air Conditions | | Induced Conditions | | |
|-------------|--------------------------------------|-------|--------------------------------------|----------|--------------------------------|
| | Temperature ^{3/} °C (°F) | | Temperature ^{3/} °C (°F) | | Humidity ^{2/} % RH |
| 0100 | 35 | (95) | 6 | 35 (95) | 6 |
| 0200 | 34 | (94) | 7 | 34 (94) | 7 |
| 0300 | 34 | (93) | 7 | 34 (94) | 7 |
| 0400 | 33 | (92) | 8 | 33 (92) | 7 |
| 0500 | 33 | (91) | 8 | 33 (92) | 7 |
| 0600 | 32 | (90) | 8 | 33 (91) | 7 |
| 0700 | 33 | (91) | 8 | 36 (97) | 5 |
| 0800 | 35 | (95) | 6 | 40 (104) | 4 |
| 0900 | 38 | (101) | 6 | 44 (111) | 4 |
| 1000 | 41 | (106) | 5 | 51 (124) | 3 |
| 1100 | 43 | (110) | 4 | 56 (133) | 2 |
| 1200 | 44 | (112) | 4 | 63 (145) | 2 |
| 1300 | 47 | (116) | 3 | 69 (156) | 1 |
| 1400 | 48 | (118) | 3 | 70 (158) | 1 |
| 1500 | 48 | (119) | 3 | 71 (160) | 1 |
| 1600 | 49 | (120) | 3 | 70 (158) | 1 |
| 1700 | 48 | (119) | 3 | 67 (153) | 1 |
| 1800 | 48 | (118) | 3 | 63 (145) | 2 |
| 1900 | 46 | (114) | 3 | 55 (131) | 2 |
| 2000 | 42 | (108) | 4 | 48 (118) | 3 |
| 2100 | 41 | (105) | 5 | 41 (105) | 5 |
| 2200 | 39 | (102) | 6 | 39 (103) | 6 |
| 2300 | 38 | (100) | 6 | 37 (99) | 6 |
| 2400 | 37 | (98) | 6 | 35 (95) | 6 |

^{1/} These cycles were derived from AR 70-38, 1 August 1979, and essentially conform to those in MIL-HDBK-310 and NATO STANAG 2895. These values represent typical conditions throughout a typical day in this climatic category. "Induced Conditions" are air temperature levels to which materiel may be exposed during storage or transit situations that are aggravated by solar loading.

^{2/} Humidity control during high temperature testing is generally not necessary. Use these values only in special cases.

^{3/} Data were originally recorded in °F and converted to °C. Hence, table data conversion may not be consistent.

TABLE 501.4-III. Summary of high temperature diurnal cycle ranges.^{1/}

| Design Type | Location | Ambient Air °C (°F) | Induced ^{2/} °C (°F) |
|-------------|--|------------------------|----------------------------------|
| Basic Hot | Many parts of the world, extending outward from hot category of the United States, Mexico, Africa, Asia, and Australia, southern Africa, South America, southern Spain and southwest Asia. | 30 - 43 (86 - 110) | 30 - 63 (86 - 145) |
| Hot | Northern Africa, Middle East, Pakistan and India, southwestern United States and northern Mexico. | 32 - 49 (90 - 120) | 33 - 71 (91 - 160) |

^{1/} The diurnal cycles for temperature and humidity are given in tables 501.4-I and -II.

^{2/} Induced conditions are air temperature levels to which materiel may be exposed during extreme storage or transit situations.

4.3 Test Interruption.

a. General. See Part One, paragraph 5.11, of this standard.

b. Specific to this method.

(1) Undertest interruption.

- (a) Cycling. If a cyclic high temperature test is being conducted and an unscheduled interruption occurs that causes the test conditions to fall out of allowable tolerances toward standard ambient temperatures, reinstate the test at the end of the last successfully completed cycle.
- (b) Steady state. If a steady state (non-cyclic) test is being conducted and an unscheduled interruption occurs that causes the test conditions to fall out of allowable tolerances toward standard ambient conditions, re-stabilize the test item at the required test temperature and continue the test from the point where test conditions were left. Record the duration of initial and final test periods.

(2) Overtest interruption (e.g., loss of chamber control).

- (a) Inspection and performance check. If an interruption in a cyclic or steady state test results in more extreme exposure of the test item than required by the materiel specifications, follow the interruption by a complete physical inspection and an operational check (where possible) before continuing the test.
- (b) Safety, performance, materials problems. When these types of problems are discovered after an overtest, the preferable course of action is to terminate the test and re-initiate testing with a new test item. If this is not done and a test item failure occurs during the remainder of the test, the test results could be considered invalid because of the overtest conditions. If no problem has been encountered, reestablish pre-interruption conditions and continue from the point where the test tolerances were exceeded.

4.4 Test Setup.

a. General. See Part One, paragraph 5.8.

b. Unique to this method. Include in the test setup any additional heat sources or an appropriate simulation (paragraph 2.3.2c).

MIL-STD-810F
1 January 2000

4.5 Test Execution.

The following steps, alone or in combination, provide the basis for collecting necessary information concerning the materiel in a high temperature environment.

4.5.1 Preparation for test.

4.5.1.1 Preliminary steps.

Before starting the test, review pretest information in the test plan to determine test details (e.g., procedures, test item configuration, cycles, durations, parameter levels for storage/operation, etc.). (See paragraph 3.1, above.)

4.5.1.2 Pretest standard ambient checkout.

All test items require a pretest standard ambient checkout to provide baseline data. Conduct the checkout as follows:

- Step 1. Install temperature sensors in, on, or around the test item as described in the test plan.
- Step 2. Install the test item in the chamber (Part One, paragraph 5.8.1) at standard ambient conditions (Part One, paragraph 5.1).
- Step 3. Conduct a visual examination of the test item with special attention to stress areas, such as corners of molded cases, and document the results.
- Step 4. Conduct an operational checkout (Part One, paragraph 5.8.2) as described in the plan and record the results.
- Step 5. If the test item operates satisfactorily, proceed to paragraph 4.5.2 or 4.5.3 as appropriate. If not, resolve the problems and repeat Step 4 above.

4.5.2 Procedure I - Storage.

- Step 1. Place the test item in its storage configuration.
- Step 2. Adjust the chamber environment to the appropriate test conditions for the start of the test period and maintain for the specified time following temperature stabilization of the test item.
- Step 3.
 - a. For cyclic storage, expose the test item to the temperature (and humidity, if applicable) conditions of the storage cycle for at least seven cycles (if 24-hour cycles are used, this would be a total of 168 hours) or as specified in the test plan. If noted in the test plan, record the thermal response of the test item.
 - b. For constant temperature storage, maintain the test temperature at least two hours following test item temperature stabilization (see Part One, paragraph 5.4). The additional two hours will help ensure unmeasured internal components actually reach stabilization. If not possible to instrument internal components, base any additional soak time on thermal analysis to ensure temperature stabilization throughout the test item.
- Step 4. At the completion of the constant temperature soak or the last cycle, adjust the chamber air temperature to standard ambient conditions and maintain until the test item temperature is stabilized.
- Step 5. Conduct a visual examination and operational checkout of the test item and record the results for comparison with pretest data.

4.5.3 Procedure II - Operation.

- Step 1. With the test item placed in the chamber in its operational configuration, install any additional temperature sensors necessary to measure the maximum temperature response of the test item, ensuring the functioning components are included.
- Step 2. From the test plan, identify the maximum operational temperature for the materiel, whether it is constant or cyclic. If constant, go to Step 3; if cyclic, go to Step 8.
- Step 3. Constant temperature exposure. Adjust the chamber air conditions to the required steady state temperature (and humidity, if applicable) at which the materiel must operate.

- Step 4. Maintain the chamber conditions at least two hours following test item temperature stabilization (see Part One, paragraph 5.4). If not possible to instrument internal components, base the additional soak time on thermal analysis to ensure temperature stabilization throughout the test item.
- Step 5. Conduct as thorough a visual examination of the test item as possible considering chamber access limitations, and document the results for comparison with pretest data.
- Step 6. Operate the test item and allow its temperature to re-stabilize. Conduct an operational checkout of the test item in accordance with the test plan and document the results for comparison with pretest data.
- Step 7. Proceed to Step 10.
- Step 8. Cycling temperature exposure. Adjust the chamber air temperature (and humidity, if applicable) to the initial conditions of the operational cycle appropriate for materiel deployment and maintain until the test item's temperature has stabilized.
- Step 9. Expose the test item to at least three cycles or the number of cycles necessary to assure repeated test item response. Conduct as complete a visual examination of the test item as possible considering chamber access limitations. Document the results.
- Step 10. Operate the test item during the maximum response period of the exposure cycle. Note that the maximum response period may not coincide with the maximum temperature cycle conditions because of the thermal lag of the test item. Repeat until a complete operational checkout of the test item has been accomplished in accordance with the approved test plan and the results have been documented.
- Step 11. With the test item not operating, adjust the chamber air temperature to standard ambient conditions and maintain until the test item temperature has stabilized.
- Step 12. Conduct a complete visual examination and operational checkout in accordance with the approved test plan and document the results for comparison with pretest data.

5. ANALYSIS OF RESULTS.

In addition to the guidance provided in Part One, paragraph 5.14, the following information is provided to assist in the evaluation of the test results. Apply any data relative to failure of a test item to meet the requirements of the materiel specifications to the test analysis, and consider related information such as:

- a. Results of nondestructive examinations (if any) of materiel following the storage test may be conducted at the extreme temperatures.
- b. Degradation or changes in operating characteristics allowed at the high extreme temperatures.
- c. Necessity for special kits or special operating procedures for high temperature exposure.
- d. Evidence of improper lubrication and assurance that the lubricants specified for the environmental condition were used.

6. REFERENCE/RELATED DOCUMENTS.

- a. AR 70-38, Research, Development, Test and Evaluation of Materiel for Extreme Climatic Conditions.
- b. MIL-HDBK-310, Global Climatic Data for Developing Military Products.
- c. Synopsis of Background Material for MIL-STD-210B, Climatic Extremes for Military Equipment. Bedford, MA: Air Force Cambridge Research Laboratories, 24 January 1974. DTIC number AD-780-508.
- d. NATO STANAG 2895, Extreme Climatic Conditions and Derived Conditions for Use in Defining Design/Test Criteria for NATO Forces Materiel.
- e. NATO STANAG 4370, Environmental Testing.
- f. Allied Environmental Conditions and Test Procedure (AECTP) 300, Climatic Environmental Tests (under STANAG 4370).

MIL-STD-810F
1 January 2000

THIS PAGE INTENTIONALLY BLANK

METHOD 502.4

LOW TEMPERATURE

NOTE: Tailoring is essential. Select methods, procedures, and parameter levels based on the tailoring process described in Part One, paragraph 4.2.2, and Appendix C. Apply the general guidelines for laboratory test methods described in Part One, paragraph 5 of this standard.

1. SCOPE.

1.1 Purpose.

Use low temperature testing to measure how low temperature conditions during storage, operation, and manipulation affect materiel safety, integrity, and performance.

1.2 Application.

Use this method when the materiel is likely to be deployed in a low temperature environment during its life cycle and the effects of low temperature have not been assessed during other tests (e.g., a temperature-altitude test).

1.3 Limitations.

This method is not intended for testing materiel to be installed in and operated in unpressurized aircraft, since such materiel would usually be tested according to method 520.2.

2. TAILORING GUIDANCE.

2.1 Selecting the Low Temperature Method.

After examining requirements documents and applying the tailoring process in Part One of this standard to determine where low temperatures are foreseen in the life cycle of the test item, use the following to confirm the need for this method and to place it in sequence with other methods.

2.1.1 Effects of low temperature environments.

Low temperatures have adverse effects on almost all basic material. As a result, exposure of materiel to low temperatures may either temporarily or permanently impair the operation of the materiel by changing the physical properties of the material(s) of which it is composed. Consider low temperature tests whenever the materiel will be exposed to temperatures below standard ambient, and consider the following typical problems to help determine if this method is appropriate for the materiel being tested. This list is not intended to be all-inclusive.

- a. Hardening and embrittlement of materials.
- b. Binding of parts from differential contraction of dissimilar materials and the different rates of expansion of different parts in response to temperature transients.
- c. Loss of lubrication and lubricant flow due to increased viscosity.
- d. Changes in electronic components (resistors, capacitors, etc.).
- e. Changes in performance of transformers and electromechanical components.
- f. Stiffening of shock mounts.
- g. Cracking of explosive solid pellets or grains, such as ammonium nitrate.
- h. Cracking and crazing, embrittlement, change in impact strength, and reduced strength.
- i. Static fatigue of restrained glass.
- j. Condensation and freezing of water.

MIL-STD-810F
1 January 2000

- k. Decrease in dexterity, hearing, and vision of personnel wearing protective clothing.
- l. Change of burning rates.

2.1.2 Sequence among other methods.

- a. General. See Part One, paragraph 5.5.
- b. Unique to this method. There are at least two philosophies related to test sequence. One approach is to conserve test item life by applying what are perceived to be the least damaging environments first. For this approach, generally apply the low temperature test early in the test sequence. Another approach is to apply environments to maximize the likelihood of disclosing synergetic effects. For this approach, consider low temperature testing following dynamic tests, such as vibration and shock. Although not written for such, this test may be used in conjunction with shock and vibration tests to evaluate the effect of dynamic events (i.e., shipping, handling, and shock) on cold materials. Also, this test may significantly alter the performance of seals during the low pressure testing of method 500.4.

2.2 Selecting Procedures.

This method includes three test procedures, Procedure I (Storage), Procedure II (Operation), and Procedure III (Manipulation). Based on the test data requirements, determine which test procedure, combination, or sequence of procedures is applicable. In most cases, all three procedures will apply.

2.2.1 Procedure selection considerations.

When selecting procedures, consider:

- a. The operational purpose of the materiel. From the requirements documents, determine the functions to be performed by the materiel in a low temperature environment and any limiting conditions, such as storage.
- b. The natural exposure circumstances.
- c. The test data required to determine whether the operational purpose of the materiel has been met.
 - (1) The expected temperature at the deployment location.
 - (2) The expected duration at the deployment location.
 - (3) The test item configuration.
- d. Procedure sequence.
 - (1) Procedure II can be preceded by Procedure I, Procedure III, or both. If the materiel is to be stored at low temperatures before use, Procedure I is conducted before Procedure II. If a manipulation test is required, Procedure III can precede the operational test. If the materiel is not intended to be stored at low temperature or manipulated before use, Procedure II is conducted directly.
 - (2) Storage testing, operational testing, or both can precede the manipulation test if required.

2.2.2 Difference among procedures.

While all procedures involve low temperatures, they differ on the basis of the timing and nature of performance tests.

- a. Procedure I - Storage. Use Procedure I to investigate how low temperatures during storage affect materiel safety during and after storage, and performance after storage.
- b. Procedure II - Operation. Use Procedure II to investigate how well the materiel operates in low temperature environments. For the purpose of this document, operation is defined as excitation of the materiel with a minimum of contact by personnel. It does not exclude handling (manipulation).

- c. Procedure III - Manipulation. Use Procedure III to investigate the ease with which the materiel can be set up and disassembled by personnel wearing heavy, cold-weather clothing.

2.3 Determine Test Levels and Conditions.

Having selected this method and relevant procedures (based on the test item's requirements documents and the tailoring process), complete the tailoring process by identifying appropriate parameter levels and applicable test conditions and techniques for these procedures. Base these selections on the requirements documents, the Life Cycle Environmental Profile, Operational Environment Documentation (see Part One, figure 1-1), and information provided with this procedure. Consider the following when selecting test levels.

2.3.1 Climatic conditions.

Select the specific test temperatures, preferably from the requirements documents. If this information is not available, determine the test temperature(s) based on the world areas in which the materiel will be used, plus any additional considerations. Although the natural low temperature environment is normally cyclic, in most instances it is acceptable to use a constant low temperature test. Only in those instances where design assessment suggests that exposure to varying low temperatures may be important are the appropriate cold cycles from either STANAG 2895, MIL-HDBK-310, or AR 70-38 recommended. The information below provides guidance for choosing the test temperatures for selected regions (climatic categories), for worldwide use without extended storage (two years or longer), and for worldwide use with extended storage periods.

- a. Selected regions. Table 502.4-II in this method and table C-I and figure C-1 in Part One of this standard can be used to determine the test temperature when the test item is to be used within specific regions only. Air temperature extremes shown in table 502.4-II are based on a one percent frequency of occurrence of the hours during the most severe month at the most severe location within the geographical area encompassed by the climatic region, except for severe cold, which is based on a 20 percent probability of occurrence. The values shown represent the range of the diurnal cycle. For this method, the lowest value in each range is usually considered.
- b. Worldwide use. When the materiel is to be stored or operated throughout the world, temperature selection must include not only consideration of the absolute cold, but also of the frequency of a given cold condition. Unless frequency is considered, it is possible to create an overtest condition. In terms of frequency, the probability-of-occurrence values shown below refer to the percent of total hours, in the most extreme month and area in the world, during which the given temperature is equaled or surpassed. For example, the 20 percent probability of occurrence of a temperature of -51°C means that -51°C or lower temperatures may be expected to occur 20 percent of the hours during the most extreme cold area of the world (excluding Antarctica). A 20 percent probability of occurrence is used for most applications with normal development cost considerations; however, to satisfy specific applications or test requirements, choose other values if desired. (See table 502.4-I.)

TABLE 502.4-I. Probabilities of occurrence of extreme low temperatures.

| Low Temperature | Probability of Occurrence |
|---|---------------------------|
| -51°C^1 (-60°F) | 20% |
| -54°C (-65°F) | 10% |
| -57°C (-71°F) | 5% |
| -61°C (-78°F) | 1% |

¹Corresponds to the "Severe Cold" condition.

- c. Worldwide use with extended storage periods. If materiel is to be stored for extended periods (years) without shelter or protection in areas that experience very low temperatures such as the "cold pole" of northeast Siberia or central Greenland, there is an increased chance that the materiel may experience much lower temperatures (approaching -65°C (-85°F)). Such prolonged exposure to extreme low temperatures can affect the safety of items such as munitions, life support equipment, etc.

MIL-STD-810F
1 January 2000

2.3.2 Duration of exposure to low temperatures.

The duration of exposure to low temperature may be a factor in materiel safety, integrity and performance.

- a. Nonhazardous or non-safety-related (non-life-support type) materiel. Most materiel in this category (in a nonoperating mode), with the possible exception of organic plastics, will not experience deterioration following temperature stabilization of the materiel at low temperatures. Following temperature stabilization of the test item, use a storage period of four hours for this materiel if no other value is available.
- b. Explosives, munitions, organic plastics, etc. These items may continue to deteriorate following temperature stabilization; consequently, it is necessary to test them at low temperatures for long periods of time. Use a minimum storage period of 72 hours following temperature stabilization of the test item, since durations of exposure of this period of time are typical for these types of items.
- c. Restrained glass. Glass, ceramics, and glass-type products (such as those used in optical systems, laser systems, and electronic systems) that require mounting or restraining in specific positions may experience static fatigue. A more extended period of low temperature may be required to induce this phenomenon. Although we do not have a specific reference, it has been reported that a 24-hour exposure usually gives an 87 percent probability of uncovering this type of design defect.

2.3.3 Test item configuration.

The configuration of the materiel is an important factor in how it may be affected by temperature. Therefore, use the anticipated configuration of the materiel during storage or use during the test. As a minimum, consider the following configurations:

- a. In a shipping/storage container or transit case.
- b. Protected or unprotected.
- c. Deployed (realistically or with restraints, such as with openings that are normally covered).
- d. Modified with kits for special applications.

2.3.4 Additional guidelines.

Review the materiel specifications and requirements documents. Apply any additional guidelines necessary.

3. INFORMATION REQUIRED.

3.1 Pretest.

The following information is required to conduct low temperature tests adequately.

- a. General. Information listed in Part One, paragraphs 5.7 and 5.9, and Part One, Appendix A, Task 405 of this standard.
- b. Specific to this method. Test temperatures, type of protective clothing required, and any additional guidelines.
- c. Temperature sensor locations. The component/assembly/structure to be used for thermal response and temperature stabilization purposes. (See Part One, paragraph 5.4.)

3.2 During Test.

Collect the following information during conduct of the test:

- a. General. Information listed in Part One, paragraph 5.10, and in Appendix A, Task 406 of this standard.
- b. Specific to this method.
 - (1) Record of chamber temperature versus time conditions.

- (2) Protective clothing used during manipulation tests.

3.3 Post Test.

The following post test information is required.

- a. General. Information listed in Part One, paragraph 5.13, and in Appendix A, Task 406 of this standard.
- b. Specific to this method.
 - (1) Length of time required for each performance check.
 - (2) Temperature-time versus data (test item and chamber).
 - (3) Clothing and special equipment used to set up or disassemble the test item.
 - (4) Appropriate anthropometric measurements of personnel performing manipulation tests.

4. TEST PROCESS.

4.1 Test Facility.

- a. The required apparatus consists of a chamber or cabinet and auxiliary instrumentation capable of maintaining and monitoring (see Part One, paragraph 5.18) the required conditions of low temperature throughout an envelope of air surrounding the test item.
- b. Unless otherwise justified by the materiel platform environment and to prevent unrealistic heat transfer in the materiel, maintain the air velocity in the vicinity of the test item so as to not exceed 1.7 m/s (335 ft/min).

4.2 Controls.

- a. Temperature. Unless otherwise specified in the test plan, if any action other than test item operation (such as opening the chamber door) results in a significant change of the test item temperature (more than 2°C (3.6°F)), restabilize the test item at the required temperature before continuing. If the operational check is not completed within 15 minutes, reestablish the test item temperature conditions before continuing.
- b. Rate of temperature change. Unless otherwise specified, control the rate of temperature change to not exceed 3°C (6°F) per minute to prevent thermal shock.
- c. Temperature measurement. Install temperature sensor instrumentation on or in the test item to measure temperature stabilization data (see Part One, paragraph 5.4).
- d. Temperature recording. Continuously record the chamber and test item temperature, if required.

4.3 Test Interruption.

- a. General. See Part One, paragraph 5.11 of this standard.
- b. Specific to this method.
 - (1) Undertest interruption. Follow an interruption that allows test temperatures to fluctuate outside allowable tolerances toward ambient conditions by a complete physical inspection and operational check (where possible). If no problems are encountered, restabilize the test item at the test temperature and continue from the point of the interruption. Since no extreme conditions were encountered, consider any problems as a test item failure.
 - (2) Overtest interruption. Follow any interruption that results in more extreme exposure of the test item than required by the materiel specification by a complete physical examination and operational check (where possible) before any continuation of testing. This is especially true where a safety problem could exist, such as with munitions. If a problem is discovered, the preferable course of action is to terminate the test and reinitiate testing with a new test item. If this is not done and test item failure occurs during the remainder of the test, the test results could be considered invalid

MIL-STD-810F
1 January 2000

because of the overtest condition. If no problem has been encountered, reestablish pre-interruption conditions and continue from the point where the test tolerances were exceeded.

4.4 Test Setup.

See Part One, paragraph 5.8.

4.5 Test Execution.

The following steps, alone or in combination, provide the basis for collecting necessary information concerning the test item in a low temperature environment. Conduct operational checkouts after storage and after manipulation to verify successful completion of both procedures.

4.5.1 Preparation for test.

4.5.1.1 Preliminary steps.

Before starting the test, review pretest information in the test plan to determine test details (e.g., procedures, test item configuration, cycles, durations, parameter levels for storage/operation, etc.).

4.5.1.2 Pretest standard ambient checkout.

All test items require a pretest standard checkout at standard ambient conditions to provide baseline data. Conduct the checkout as follows (change of step sequence may be required for large test items):

- Step 1. Install temperature sensors in or on the test item as required to determine the test item temperature(s).
- Step 2. Insert the test item into the chamber and stabilize it at standard ambient conditions (See Part One, paragraph 5.1).
- Step 3. Conduct a complete visual examination of the test item, with special attention to stress areas such as corners of molded cases.
- Step 4. Document the results.
- Step 5. Prepare the test item in its required configuration in accordance with Part One, paragraph 5.8.1, and configure the test item as required.
- Step 6. Conduct an operational checkout in accordance with the approved test plan and record the results.
- Step 7. If the test item operates satisfactorily, proceed to the first test procedure as determined from the test plan. If not, resolve the problems and repeat Step 6 above.

4.5.2 Procedure I - Storage.

- Step 1. Adjust the test item to its storage configuration and install it in the test chamber.
- Step 2. Adjust the chamber air temperature to that specified in the test plan for storage.
- Step 3. Following temperature stabilization of the test item (Part One, paragraph 5.4), maintain the storage temperature for a period as specified in the test plan.
- Step 4. Conduct a visual examination of the test item and compare the results with the pretest data. Record any pertinent physical changes or the fact that there were no obvious changes.
- Step 5. If low temperature operation is required, proceed to paragraph 4.5.3, Step 4, otherwise, proceed to Step 6 below.
- Step 6. Adjust the chamber air temperature to standard ambient and maintain until the test item has achieved temperature stabilization.
- Step 7. Conduct a complete visual examination of the test item and document the results.
- Step 8. If appropriate, conduct an operational checkout of the test item and document the results.
- Step 9. Compare these data with the pretest data.

4.5.3 Procedure II - Operation.

- Step 1. With the test item in the test chamber, adjust the chamber air temperature to the low operating temperature of the test item as specified in the test plan. Maintain at least two hours following temperature stabilization of the test item.

- Step 2. Conduct as complete a visual examination of the test item as chamber access limitations will allow.
- Step 3. Document the results.
- Step 4. Conduct an operational checkout of the test item as in paragraph 4.5.1.2, Step 6.
- Step 5. Document the results.
- Step 6. If manipulation of the test item is required at low temperature, proceed to Step 4 of paragraph 4.4.4. If not, proceed to step 7 of this procedure.
- Step 7. Adjust the chamber air temperature to standard ambient and maintain until temperature stabilization of the test item has been achieved.
- Step 8. Conduct a complete visual examination of the test item.
- Step 9. Document the results.
- Step 10. If appropriate, conduct an operational checkout and record results for comparison with data obtained in paragraph 4.5.1.2, Step 6.

4.5.4 Procedure III - Manipulation.

- Step 1. With the test item in the test chamber, adjust the chamber air temperature to the low operating temperature of the test item as determined from the test plan. Maintain for two hours following temperature stabilization of the test item.
- Step 2. While maintaining the low operating temperature, place the test item in its normal operating configuration by using the options of Step 4.
- Step 3. Reestablish the temperature to that used in Step 1, above.
- Step 4. Based on the type of test chamber available, select one of the two following options:
 - Option 1 - To be used when a "walk-in" type chamber is available: With personnel clothed and equipped as they would be in a low temperature tactical situation, disassemble the test item as would be done in the field, and repack it in its normal shipping/storage container(s), transit case, or other mode and configuration.
 - Option 2 - To be used when small chambers (non-walk-in) are used: Perform the option 1 procedure, except the disassembly and packing will be performed by personnel reaching through chamber access holes or the open door while they are wearing heavy gloves such as would be required in the natural environment. NOTE - Opening of the chamber door may cause frost to form on the test item in addition to a gradual warming of the test item. Limit manipulation necessary to perform the required setup or teardown to 15-minute intervals, between which reestablish the temperature of step 1 above.
- Step 5. If operation of the test item is required at low temperatures, repeat step 2, above, and then proceed to Step 1 of paragraph 4.5.3. If not, proceed to step 6 of this procedure.
- Step 6. Conduct a complete visual examination of the test item.
- Step 7. Document the results for comparison with the pretest data.
- Step 8. Adjust the chamber air temperature to standard ambient and maintain until the test item has reached temperature stabilization.
- Step 9. Conduct a complete visual examination of the test item.
- Step 10. Document the results.
- Step 11. If appropriate, conduct an operational checkout of the test item and record results for comparison with data obtained in paragraph 4.5.1.2, Step 6.

5. ANALYSIS OF RESULTS.

In addition to the guidance provided in Part One, paragraph 5.14, the following information is provided to assist in the evaluation of the test results. Apply any data relative to failure of a test item to meet the requirements of the materiel specifications to the test analysis, and consider related information such as:

- a. Nondestructive test/examination following exposure to low temperature may be conducted at the low test temperature.
- b. Degradation allowed in operating characteristics when at low temperatures.
- c. Necessity for special kits or special cold weather procedures.

MIL-STD-810F
1 January 2000

- d. Evidence of improper lubrication and assurance that lubricants specified for the environmental condition were used.
- e. For starting failure on internal combustion engines, assurance of the presence of proper fuels and deicers, if appropriate.
- f. Condition and adequacy of the power source.

6. REFERENCE/RELATED DOCUMENTS.

- a. AR 70-38, Research, Development, Test and Evaluation of Materiel for Extreme Climatic Conditions.
- b. MIL-HDBK-310, Global Climatic Data for Developing Military Products.
- c. Synopses of Background Material for MIL-STD-210B, Climatic Extreme for Military Equipment. Bedford, MA: Air Force Cambridge Research Laboratories, January 1974. DTIC number AD-780-508.
- d. NATO STANAG 2895, Extreme Climatic-Conditions and Derived Conditions for Use in Defining Design/Test Criteria for NATO-Forces Materiel.
- e. STANAG 4370, Environmental Testing.
- f. Allied Environmental Conditions and Test Publication 300, Climatic Environmental Tests (under STANAG 4370).

TABLE 502.4-II. Summary of low temperature cycle ranges.^{1/}

| DESIGN TYPE | LOCATION | TEMPERATURE | |
|------------------|---|----------------------------|----------------------------|
| | | Ambient Air °C (°F) | Induced °C (°F) |
| Mild Cold (CO) | Coastal areas of western Europe under prevailing maritime influence, Southeast Australia; Lowlands of New Zealand | -6 to -19 (21 to -2) | -10 to -21 (14 to -6) |
| Basic Cold (C1) | Most of Europe; Northern contiguous US; Southern Canada; High-latitude coasts (e.g., southern coast of Alaska); High elevations in lower latitudes | -21 to -31 (-6 to -24) | -25 to -33 (-13 to -27) |
| Cold (C2) | Northern Canada, Alaska (excluding the interior); Greenland (excluding the "cold pole"); Northern Scandinavia; Northern Asia (some areas) High Elevations (Northern and Southern Hemispheres); Alps; Himalayas; Andes | -37 to -46 (-35 to -51) | -37 to -46 (-35 to -51) |
| Severe Cold (C3) | Interior of Alaska; Yukon (Canada); Interior of Northern Islands; Greenland ice cap; Northern Asia | -51 (-60) | -51 (-60) |

^{1/} These cycles were derived from AR 70-38, 1 August 1979, and essentially conform to those in MIL-HDBK-310 and NATO STANAG 2895. These values represent typical conditions. Induced conditions are extreme levels to which materiel may be exposed during storage or transit situations, such as inside an unventilated field storage shelter or a railway car. Do not use these levels carte blanche, but tailor them to the anticipated storage or transit situation.

MIL-STD-810F
1 January 2000

THIS PAGE INTENTIONALLY BLANK

METHOD 503.4

TEMPERATURE SHOCK

NOTE: Tailoring is essential. Select methods, procedures, and parameter levels based on the tailoring process described in Part One, paragraph 4.2.2, and Appendix C. Apply the general guidelines for laboratory test methods described in Part One, paragraph 5 of this standard.

1. SCOPE.

1.1 Purpose.

Use temperature shock tests to determine if materiel can withstand sudden changes in the temperature of the surrounding atmosphere without experiencing physical damage or deterioration in performance. For the purpose of this document, "sudden changes" is defined as "greater than 10°C per minute."

1.2 Application.

1.2.1 Normal environment.

Use this method when the requirements documents specify the materiel is likely to be deployed where sudden significant changes of air temperature may be experienced. This method is intended to only evaluate the effects of sudden temperature changes of the outer surfaces of materiel, items mounted on the outer surfaces, or internal items situated near the external surfaces. Typically, this addresses:

- a. The transfer of materiel between heated areas and low temperature environments.
- b. Ascent from a high temperature ground environment to high altitude via a high performance vehicle (hot to cold only).
- c. Air drop at high altitude/low temperature from heated aircraft enclosures when only the external material (packaging or materiel surface) is to be tested.

1.2.2 Safety and screening.

Except as noted in paragraph 1.3, use this method to reveal safety problems and potential flaws in materiel normally exposed to less extreme rates of temperature change (as long as the test conditions do not exceed the design limitations of the materiel). Although not intended to be used for environmental stress screening (ESS), with proper engineering this method can also be used as a screening test (using more extreme temperature shocks) to reveal potential flaws in materiel exposed to less extreme temperature change conditions.

1.3 Limitations.

This method is not intended for materiel that will not experience sudden extreme temperature changes because of its packaging, installed location, etc. This method does not replace the assessment of performance characteristics after lengthy exposure to extreme temperatures, such as with methods 501.4 and 502.4. Additionally, this method does not address the temperature shock experienced by materiel transferred between air and liquid or two liquids, the thermal shock caused by rapid transient warmup by engine compressor bleed air, or aerodynamic loading. Except for ESS, this method is inappropriate if the actual transfer time in a service environment will not produce a significant thermal shock. Additionally, this method does not address materiel that has been exposed to heat from a fire and subsequently cooled with water.

MIL-STD-810F
1 January 2000

2. TAILORING GUIDANCE.

2.1 Selecting this Method.

After examining requirements documents and applying the tailoring process in Part One of this standard to determine where thermal shocks are foreseen in the life cycle of the materiel, use the following to confirm the need for this method and to place it in sequence with other methods.

2.1.1 Effects of thermal shock environments.

Effects of thermal shocks are usually more severe near the outer portions of materiel. The further from the surface (depending, of course, on the properties of the material involved), the slower and less significant the thermal changes. Transit cases, packaging, etc. will lessen the effects of thermal shock on the enclosed materiel even more. Sudden temperature changes may either temporarily or permanently affect operation of materiel. The following are examples of problems that could result from thermal shock exposure that may relate to the materiel being tested. Consider the following typical problems to help determine if this method is appropriate for the materiel being tested. This list is not intended to be all-inclusive.

- a. Physical.
 - (1) Shattering of glass vials and optical materiel.
 - (2) Binding or slackening of moving parts.
 - (3) Cracking of solid pellets or grains in explosives.
 - (4) Differential contraction or expansion rates or induced strain rates of dissimilar materials.
 - (5) Deformation or fracture of components.
 - (6) Cracking of surface coatings.
 - (7) Leaking of sealed compartments.
 - (8) Failure of insulation protection.
- b. Chemical.
 - (1) Separation of constituents.
 - (2) Failure of chemical agent protection.
- c. Electrical.
 - (1) Changes in electrical and electronic components.
 - (2) Electronic or mechanical failures due to rapid water or frost formation.
 - (3) Excessive static electricity.

2.1.2 Sequence among other methods.

- a. General. See Part One, paragraph 5.5.
- b. Unique to this method. Use test item response characteristics and performance determination information obtained from the high and low temperature tests to better define the test conditions to be used for this procedure.

2.2 Selecting Procedures.

This method includes two test procedures, Procedure I (Steady State) and Procedure II (Cyclic). Determine the procedure(s) to be used.

2.2.1 Procedure selection considerations.

When selecting procedures, consider:

- a. The expected exposure temperatures in service.
- b. The materiel's logistic or deployment configuration.
- c. Environmental stress screening (ESS) requirements.

2.2.2 Difference between procedures.

While both procedures involve temperature conditioning and performance testing, they differ on the basis of temperature stabilization prior to shocks.

- a. Procedure I - Steady State. Procedure I employs constant temperature at each of the extreme shock conditions because, in many instances, the thermal shock itself so outweighs the other thermal effects that the test may be performed using two constant temperatures. This is particularly the case when more severe shocks are desired, such as for evaluation of safety or initial design, and when extreme values will be used.
- b. Procedure II - Cyclic. When a careful simulation of a real environment is required, use Procedure II because the upper temperature follows part of an appropriate diurnal cycle. From the requirements documents determine the function (operational requirement) to be achieved by the materiel and a definition of the circumstances responsible for the thermal shock.

2.3 Determine Test Levels and Conditions.

Having selected this method and relevant procedures (based on the test item's requirements documents and the tailoring process), complete the tailoring process by identifying appropriate parameter levels and applicable test conditions and techniques for these procedures. Base these selections on the requirements documents, the Life Cycle Environmental Profile, Operational Environment Documentation (see Part One, figure 1-1), stress screening requirements and information provided with this procedure. Consider tailoring known service extreme temperatures if the intent of the test is to reproduce induced strain rates found in service. Use values other than those suggested if realistic. Consider the following when selecting test levels. This method addresses several exposure situations: aircraft flight exposure, air delivery - desert, and ground transfer or air delivery - arctic. Based on the anticipated deployment, determine which test variation is applicable. The extreme exposure range should determine the test conditions, but extend the test levels as necessary to detect design flaws.

- a. Aircraft flight exposure. This is appropriate if the materiel is to be exposed to desert or tropical ground heat and possible direct solar heating and, a few minutes later, exposed to the extreme low temperatures associated with high altitude.
- b. Air delivery - desert. This is appropriate for materiel which is delivered over desert terrain from unheated, high-altitude aircraft, but use the ambient air temperature (no solar loading).
- c. Ground transfer or air delivery - arctic. This is intended to test materiel for the effects of movement to and from heated storage, maintenance, or other enclosures or a heated cargo compartment in cold regions.
- d. Engineering design. This is used to detect marginal design issues.
- e. ESS. ESS is used for evaluating workmanship practices.

2.3.1 Climatic conditions.

Identify the appropriate climatic conditions for the geographic areas in which the materiel will be operated and stored. Actual response temperatures achieved when materiel is exposed to the climatic conditions of the various ground climatic categories could be obtained from the test results of high and low temperature exposure (methods 501.4, 502.4, and 505.4) for either the operational or storage configuration. The latter assumption must take into account the induced effects of solar radiation during storage and transit in various climates.

MIL-STD-810F
1 January 2000

2.3.2 Exposure conditions.

Select the test temperatures from field data or from the requirements documents, if available. If not available, determine the test temperatures from the anticipated deployment application or world areas in which the materiel will be deployed, or from the most extreme nonoperating temperature requirements. Except for stress screening purposes, recommend using a range of temperatures that reflects that anticipated in service rather than some arbitrary extreme range.

- a. Deployment application (aircraft flight exposure). The thermal stresses and rates that materiel will experience during exposure to the air flight operational environment are dependent upon the ambient conditions, flight conditions, and performance of the onboard environmental control systems. The temperature and humidity at various altitudes can be found in MIL-HDBK-310.
- b. Air delivery/airdrop. The test conditions for this exposure are based upon the probable conditions in the cargo compartment of the aircraft (or other transport location) and on the ground at the point of impact. Use a lower temperature extreme that assumes an unheated, unpressurized aircraft cargo compartment with the aircraft at an altitude of 8 kilometers (26,200 ft). This is the limiting altitude for cargo aircraft because of oxygen-pressure requirements when the aircraft cargo compartment is unpressurized immediately before airdrop operations. The temperature at this altitude can be found in MIL-HDBK-310. Determine the high temperature surface extremes from the appropriate tables in method 501.4. NOTE: Materiel packaging will normally mitigate thermal shocks. The air delivery/airdrop scenario may not involve significant thermal shock to the materiel itself.
- c. Ground transfer/air delivery - arctic. The conditions developed for heated enclosures located in cold regions are 21°C (70°F) and 25 percent relative humidity. These conditions roughly correspond to normal heating practices in the Arctic and on aircraft. Base selection of the outside ambient conditions upon the climatic categories or areas listed in the appropriate table in method 502.4.
- d. Engineering design. Use test conditions that reflect the extreme anticipated storage conditions.

2.3.3 Test duration (number of shocks).

For materiel that is likely to be exposed only rarely to thermal shock, perform one shock for each appropriate condition. There is little available data to substantiate a specific number of shocks when more frequent exposure is expected. In lieu of better information, apply three shocks or more at each condition, the number depending primarily on the anticipated service events. The objective of this test is to determine the effect of rapid temperature changes on the materiel. Therefore, expose the test item to the temperature extremes for a duration equal to either the actual operation (i.e., actual flight time) or to that required to achieve temperature stabilization.

2.3.4 Extreme high temperature exposure.

Materiel is likely to experience the highest heating during storage in the sun in the Hot Dry and Basic Hot climatic regions. Therefore, conduct transitions from hot to cold with the test item stabilized at its high storage temperature. Conduct transitions from cold to hot with the high temperature facility's air temperature at the maximum storage temperature of the appropriate cycle. Immediately following the cold-to-hot transfer, cycle the high temperature facility through the appropriate diurnal cycle (method 501.4) from the beginning of the hour at which the maximum air temperature is experienced until the test item maximum operational response temperature is reached (see method 501.4, paragraph 2.3.3b). Other tests, such as stress screening, may require even more extreme temperatures.

2.3.5 Test item configuration.

The configuration of the test item strongly affects test results. Therefore, use the anticipated configuration of the item during storage, shipment, or use. As a minimum, consider the following configurations:

- a. In a shipping/storage container or transit case, and installation of a thermally conditioned item into a container conditioned at another temperature.
- b. Protected or unprotected.
- c. Deployed (realistically or with restraints).

- d. Modified with kits for special applications.
- e. Packaged for airdrop.

2.3.6 Temperature stabilization.

Stabilize the test item temperature (prior to transfer) for as long as necessary to ensure a uniform temperature throughout at least the outer portions of the test item.

2.3.7 Relative humidity.

For most test programs, the relative humidity (RH) is not controlled. During the thermal shock test it may, however, have a significant effect on some materiel, e.g., cellulosic materials which are typically porous, into which moisture can migrate and then expand upon freezing. Do not attempt to control relative humidity unless specifically required.

2.3.8 Transfer time.

Ensure the transfer time reflects the time associated with the actual thermal shock in the life cycle profile. It should be as rapid as possible, but if the transfer takes more than one minute, justify the extra time.

2.4 Special Considerations.

The test conditions as presented in this procedure are intended to be in general agreement with other extremes described in this document. The primary purpose in establishing these levels is to provide realistic conditions for the traverse between the two temperature extremes. Therefore, before transfer, stabilize the test item at the most realistic temperature that would be encountered during the specific operation, or possibly the most extreme test item stabilization temperature, if appropriate. Consider tailoring known service extreme temperatures, if the intent of the test is to reproduce induced strain rates found in service.

3. INFORMATION REQUIRED.

3.1 Pretest.

The following information is required to conduct temperature shock tests adequately.

- a. General. Information listed in Part One, paragraphs 5.7 and 5.9, and Appendix A, Task 405 of this standard.
- b. Specific to this method.
 - (1) Test item configuration.
 - (2) Test temperature extremes or test item thermal rates of change.
 - (3) Duration of exposure at each temperature.
 - (4) Test item response temperature (from method 501.4).
 - (5) For Procedure II, the high temperature cycle, and the initial temperature for the temperature cycling.
 - (6) The component/assembly/structure to be used for thermal response and temperature stabilization purposes (if required). (See Part One, paragraph 5.4.)

3.2 During Test.

For test validation purposes, record deviations from planned or pre-test procedures or parameter levels, including any procedural anomalies that may occur.

3.3 Post-test.

Record the following post-test information.

- a. General. Information listed in Part One, paragraph 5.13, and in Appendix A, Task 406 of this standard.

MIL-STD-810F
1 January 2000

b. Specific to this method.

- (1) Previous test methods to which the specific test item has been exposed.
- (2) Duration of each exposure.
- (3) Status of the test item for each visual examination.
- (4) Test temperatures.
- (5) Results of operational checks.
- (6) Transfer times (e.g., "door open" to "door closed").

4. TEST PROCESS.

4.1 Test Facility.

4.1.1 Apparatus.

The required apparatus consists of two chambers or cabinets, or a two-celled chamber in which the test conditions can be established and maintained. Unless otherwise specified, use chambers equipped so that, after transfer of the test item, the test conditions within the chamber can be stabilized within five minutes. Use materiel handling equipment, if necessary, for transfer of the test item between chambers.

4.1.2 Instrumentation.

Use chambers equipped with auxiliary instrumentation capable of monitoring (see Part One, paragraph 5.18) the test conditions throughout an envelope of air surrounding the test item(s). (See Part One, paragraph 5.3.) Quick-disconnect thermocouples may be necessary for monitoring test item conditions following changes.

4.2 Controls.

4.2.1 Temperature.

Unless otherwise specified in the test plan, if any action other than test item operation (such as opening of the chamber door, except at transfer time) results in a significant change (more than 2°C (3.6°F)) of the test item temperature or chamber air temperature, stabilize the test item at the required temperature before continuation.

4.2.2 Air velocity.

Unless justified by the materiel's platform environment, and to provide standard testing conditions, use an air velocity that does not exceed 1.7 m/s (335 ft/min) in the vicinity of the test item.

4.2.3 Transfer time.

Transfer the test item between the two environments (high and low temperatures) as rapidly as possible but in no more than five minutes (unless the test item is large and requires handling equipment). If the transfer requires more than five minutes, re-assess the need for a thermal shock test.

4.3 Test Interruption.

a. General. See Part One, paragraph 5.11 of this standard.

b. Specific to this method.

- (1) Undertest interruption. If, before the temperature change, an unscheduled test interruption occurs that causes the test conditions to exceed allowable tolerances toward standard ambient temperatures, reinitiate the test at the point of interruption and reestablish the test item at the test condition. If the

interruption occurs during the transfer, reestablish the test item at the previous temperature and then transfer.

- (2) **Overtest interruption.** Follow any interruption that results in more extreme exposure of the test item than required by the materiel specification by a complete physical examination and operational check of the test item (where possible) before any continuation of testing. This is especially true where a safety problem could exist, such as with munitions. If a problem is discovered, the preferable course of action is to stop the test and start over with a new test item. If this is not done and test item failure occurs during the remainder of the test, the test results could be invalid due to the overtest condition. If no problem is discovered, reestablish pre-interruption conditions and continue from the point where the test tolerances were exceeded.

4.4 Test Execution.

The following steps, alone or in combination, provide the basis for collecting necessary information concerning the materiel's susceptibility to temperature shock.

4.4.1 Preparation for test.

4.4.1.1 Preliminary steps.

Before starting the test, review pretest information in the test plan to determine test details (e.g., procedures, test item configuration, temperature levels, cycles, temperature stabilization determination, durations, etc.). (See paragraph 3.1 above.)

4.4.1.2 Pretest standard ambient checkout.

All test items require a pretest standard ambient checkout to provide baseline data. Examine munitions and other appropriate materiel by nondestructive examination methods. Conduct the checkout as follows:

- Step 1. Stabilize the test item at standard ambient conditions (Part One, paragraph 5.1).
- Step 2. Conduct a complete visual examination of the test item (evaluate against paragraph 2.1.1) with special attention to stress areas such as corners of molded areas and interfaces between different materials (e.g., component lead/ceramic interfaces of visible electronic parts), and document the results for comparison with post test data.
- Step 3. Conduct an operational checkout in accordance with the approved test plan and record the results.
- Step 4. If the test item operates satisfactorily, proceed to the next Step. If not, resolve the problems and restart at Step 1, above.
- Step 5. Prepare the test item in accordance with Part One, paragraph 5.8 and in the required test item configuration.

4.4.2 Procedures.

The following procedures provide the basis for collecting the necessary information concerning the materiel in a severe temperature shock environment. The procedures depicted on figures 1 and 2 arbitrarily begin with the lower temperature, but could be reversed to begin with the higher temperature if it is more realistic. Specific points on figures 1 and 2 (in parentheses) are referenced in the following text.

MIL-STD-810F
1 January 2000

4.4.2.1 Procedure I - Shock from constant extreme temperatures. (Figure 503.4-1.)

- Step 1. With the test item in the chamber, adjust the chamber air temperature to the low temperature extreme specified in the test plan (a). Maintain this temperature for a period as determined in the test plan (a-b).
- Step 2. Transfer the test item in no more than one minute (b-c) to an atmosphere at temperature T2 that will produce the thermal shock specified in the test plan, and maintain this temperature as specified in the test plan (c-e).
- Step 3. If required in the test plan, evaluate the effects of the thermal shock on the test item to the extent practicable.
- Step 4. If other cycles in reversed directions are required, transfer the test item to the T1 environment in less than one minute (e-f) and stabilize as required in the test plan (f-b), evaluate the thermal shock effects (if required), and continue as in steps 2 and 3 above. If other one way shocks are required, return the test item to the T1 environment at a rate of not more than 3°C/minute and repeat Steps 1-3. If no other shocks are required, go to Step 5.
- Step 5. Return the test item to standard ambient conditions.
- Step 6. Examine the test item and, if appropriate, operate. Record the results for comparison with pretest data.

4.4.2.2 Procedure II - Shock to/from cyclic high temperatures. (Figure 503.4-2.)

- Step 1. With the test item in the chamber, adjust the chamber air temperature to the low temperature extreme specified in the test plan (a) at a rate not to exceed 3°C/min. Maintain this temperature for a period as determined in the test plan (a-b).
- Step 2. Transfer the test item to the maximum air temperature of the high temperature cycle (c) (as specified in the test plan) in no more than one minute. As soon as the chamber door is closed and the chamber recovers to the peak temperature, cycle the chamber through part of the appropriate diurnal cycle until the chamber air temperature reaches the test item response temperature (d) (obtained from method 501.4, paragraph 2.3.3b). Maintain this temperature as specified in the test plan (d-e).
- Step 3. If no other cycles are required, return the test item to standard ambient conditions and proceed to Step 7.
- Step 4. Transfer the test item to the lower temperature environment (f) in no more than one minute and stabilize as required in the test plan (f-h). If other cycles are required, proceed to Step 6.
- Step 5. If no other cycles are required, return the test item to standard ambient conditions, and proceed to Step 7.
NOTE: Unless the requirements documents indicate otherwise, if the test procedure is interrupted because of work schedules, etc., maintaining the test item at the test temperature for the time required will facilitate completion of the test when resumed. If the temperature is changed, before continuing the test, restabilize the test item at the temperature of the last successfully completed period before the interruption.
- Step 6. Repeat steps 2, 3, and 4 as specified in the test plan.
- Step 7. Examine the test item and, if appropriate, operate. Record the results for comparison with pretest data.

5. ANALYSIS OF RESULTS.

Follow the guidance provided in Part One, paragraph 5.14, to assist in the evaluation of the test results. Analyze any failure of a test item to meet the requirements of the materiel specifications.

6. REFERENCE/RELATED DOCUMENTS.

- a. MIL-HDBK-310, Global Climatic Data for Developing Military Products.
- b. NATO STANAG 2895, Extreme Climatic-Conditions and Derived Conditions for Use in Defining Design/Test Criteria for NATO-Forces Materiel.
- c. STANAG 4370, Environmental Testing.
- d. Allied Environmental Conditions and Test Publication 300, Climatic Environmental Testing (under STANAG 4370).

MIL-STD-810F
1 January 2000

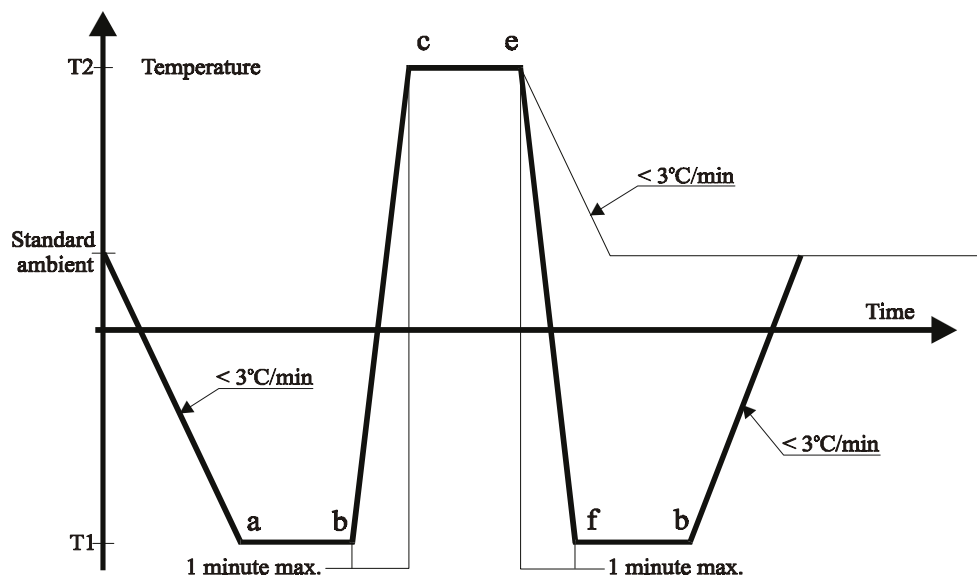

FIGURE 503.4-1. Shocks from constant extreme temperature.

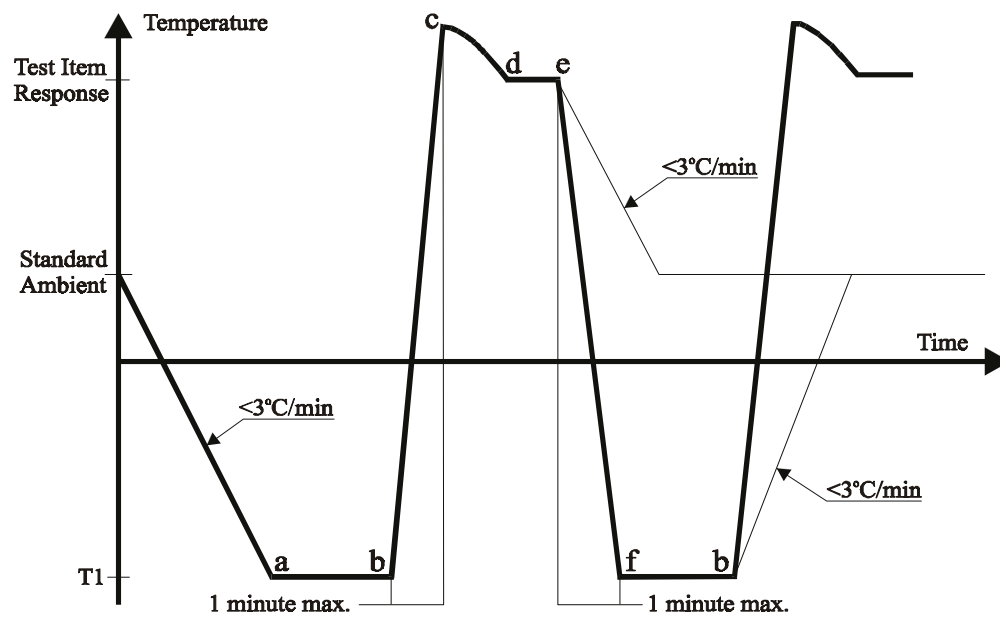

FIGURE 503.4-2. Shocks from cyclic high temperature.

METHOD 504

CONTAMINATION BY FLUIDS

NOTE: Tailoring is essential. Select methods, procedures, and parameter levels based on the tailoring process described in Part One, Paragraph 4.2.2, and Appendix C. Apply the general guidelines for laboratory test methods described in Part One, paragraph 5 of this standard.

1. SCOPE.

1.1 Purpose.

Use contamination by fluids tests to determine if materiel is unacceptably affected by temporary exposure to contaminating fluids (liquids) such as may be encountered during its life cycle, either occasionally^{1/}, intermittently^{2/}, or over extended periods^{3/}.

1.2 Application.

Select the tests described in this method when there is a high probability of fluid contamination during the life cycle of the materiel. Contamination may arise from exposure to fuels, hydraulic fluids, lubricating oils, solvents, and cleaning fluids, de-icing and anti-freeze fluids, runway de-icers, insecticides, disinfectants, coolant dielectric fluid, and fire extinguishants.

WARNING: THIS METHOD REQUIRES THE USE OF SUBSTANCES AND/OR TEST PROCEDURES THAT MAY HAVE AN ENVIRONMENTAL IMPACT OR BE INJURIOUS TO HEALTH, IF ADEQUATE PRECAUTIONS ARE NOT TAKEN. ADDITIONAL INFORMATION IS PROVIDED IN ANNEX A. REFER TO THE SUPPLIER'S MATERIAL SAFETY DATA SHEET (MSDS) OR EQUIVALENT FOR CHEMICAL COMPATIBILITY AND HEALTH HAZARD DATA ON THE VARIOUS CHEMICALS USED, AND COORDINATE WITH LOCAL ENVIRONMENTAL AUTHORITIES. ENSURE ALL POST-TEST MATERIALS ARE DISPOSED OF IN ACCORDANCE WITH LOCAL, STATE AND FEDERAL REGULATIONS.

1.3 Limitations.

This test is not intended to demonstrate the suitability of materiel to perform during continuous contact with a fluid, e.g., an immersed fuel pump, nor should it be used to demonstrate resistance to electrolytic corrosion.

2. TAILORING GUIDANCE.

2.1 Selecting the Contamination by Fluids Method.

After examining requirements documents and applying the tailoring process in Part One of this standard to determine where exposure to contaminating fluids is foreseen in the life cycle of the test item, use the following to confirm the need for this method and to place it in sequence with other methods. For specifically testing small arms systems, consider using Test Operations Procedure (TOP) 3-2-609.

2.1.1 Effects of the contaminating fluids environment.

During its life cycle, materiel may be accidentally or intentionally exposed to one or more fluids that could have an adverse effect on the materiel. As a result, exposure of materiel to contaminating fluids may either temporarily or permanently impair the operation of the materiel by changing the physical properties of the material(s) composing it. Consider the following typical examples of problems to help determine if this method is appropriate for the materiel being tested. The list is not intended to be all-inclusive and some of the examples may overlap.

- a. Packaging failure.
- b. Cracking or swelling of plastics and rubbers.

^{1/} Extraordinary/unusual circumstances occurring once or twice a year.

^{2/} Regular basis under normal operation; possibly seasonally over the life of the materiel.

^{3/} Long periods such that materiel is thoroughly exposed.

MIL-STD-810F
1 January 2000

- c. Leeching of antioxidants and other soluble materials.
- d. Seal or gasket failures.
- e. Adhesion failures.
- f. Paint/legend removal.
- g. Corrosion.
- h. Melting or decomposition.

2.1.2 Sequence among other methods.

- a. General. See Part One, paragraph 5.5.
- b. Unique to this method. Do not perform these tests prior to other climatic environmental tests because of potential effect of the contaminants or their removal by decontaminants.

2.2 Selecting Procedure Variations.

This method has one procedure. Possible variations are described below. The most significant parameters used in this test method are the fluid to be used, the temperature, and duration of exposure. It is also important in this test procedure to specify the operational configuration of the test item, as well as whether or not the test item is heat dissipating during operation.

2.2.1 Length of exposure.

There are three options provided in the test procedure: occasional contamination, intermittent contamination, and extended contamination (paragraph 1.1). From the requirements document, determine the option to be used based on the anticipated life cycle scenario, along with the order of application of the test fluids if more than one is required.

2.2.2 Contaminant fluid groups. (See paragraph 2.2.3 below.)

The following groups of fluids are listed in table 504-I.

2.2.2.1 Fuels.

Fuels will, for the most part, be of the gasoline or kerosene type, and whereas the former may be expected to evaporate rapidly - possibly with few permanently harmful effects, the latter - being more persistent - can be damaging to many elastomers, particularly at elevated temperatures. Paints and most plastics are normally not affected by fuels, but silicone resin bonded boards may tend to de-laminate after prolonged exposure. Some fuels may have additives to inhibit icing or to dissipate static charges. Where there is reason to believe that these additives may increase the severity of the test, include them in the test fluids.

2.2.2.2 Hydraulic fluids.

Commonly used hydraulic fluids may be of the mineral oil or ester-based synthetic type. The latter are damaging to most elastomers and to plastics; phosphate esters are especially damaging to these materials and to paint finishes.

2.2.2.3 Lubricating oils.

Mineral or synthetic-based lubricating oils may be at elevated temperatures in their working states. Mineral oil is damaging to natural rubber but less so to synthetics such as polychloroprene, chloro-sulphonated polyethylene, and silicone rubber. Synthetic lubricants are extremely damaging to plastics such as PVC as well as to many elastomers.

2.2.2.4 Solvents and cleaning fluids.

Many areas of aircraft or vehicles may require dirt or grease removal before servicing can begin. The fluids given in table I are representative of those presently in use.

2.2.2.5 De-icing and anti-freeze fluids.

These fluids may be applied, often at elevated temperatures, to the leading edges, intakes, etc., of aircraft and may penetrate areas where they can contaminate components and materiel. These fluids are based, typically, on inhibited ethylene glycols.

2.2.2.6 Runway de-icers.

These fluids are used on runways and other areas to lower the freezing point of water. They may penetrate the undercarriage and equipment bays of aircraft as a fine mist.

2.2.2.7 Insecticides.

Aircraft flying in and through the tropics may be treated with insecticide sprays as a routine precaution. While it is unlikely that these will have a directly adverse effect on materiel, it may be necessary to make exploratory tests using a proprietary insecticide.

2.2.2.8 Disinfectants.

The primary contaminating agent is likely to be the disinfectant used, which will be a formaldehyde/phenol preparation, and its use on waste liquid in/from galleys and toilet compartments, where a leak may permit contamination of materiel below the leak.

2.2.2.9 Coolant dielectric fluids.

These are used as thermal transfer liquids to assist cooling of certain equipment. They are usually based on silicate ester materials, and their effects on materials may be considered to be similar to the phosphate ester hydraulic fluids, although not quite as severe.

2.2.2.10 Fire extinguishants.

Halon (chloro bromo fluoro hydrocarbon) or similar compounds are likely to be used on aircraft, and will be relatively short-lived. Ground-based extinguishants are aqueous foams derived from fluoro chemicals or fluoroproteins. Their effects will be mainly due to water or buildup of trapped residues. The necessity for testing with these products is based on the need to maintain equipment functioning after release of the extinguishant.

2.2.3 Test fluid(s).

Select the test fluid(s) from those listed in table 504-I which are representative of those commonly encountered during the life cycle. Each specified test fluid is the worst case representative of a group of fluids and is the most likely to affect the performance of the materiel. In the requirements document, list other fluids identified during the tailoring process as possible contaminants. Service grades of fluids may be changed or modified with development formulations and equipment demands. Some may subsequently be found undesirable because of environmental or health and safety problems. Table 504-I may be updated as necessary in the future.

2.2.4 Combination of test fluids^{4/}.

When more than one test fluid is to be applied, consider the following:

- a. the need to assess the effect of the fluids individually, combined, or in succession.
- b. if the order of exposure to fluids in service is known, or if the order of exposure to fluids recognized as having synergistic effects is known and is realistic in service, specify this order.
- c. if the test item should be cleaned between or after tests, or if a new test item should be used for each test fluid. Choice of cleaning fluid should not result in further contamination. Some of the specified test fluids may be used as cleaning fluids (e.g., aviation fuel, solvents, or cleaning fluids), otherwise use a fluid known to be used in normal cleaning procedures.

^{4/} When mixing two or more fluids, ensure they are compatible and will not produce hazardous reactions.

MIL-STD-810F
1 January 2000

2.2.5 Test temperature.

Use temperatures representative of the actual conditions under which fluid contamination can occur either intentionally or accidentally. The application of contaminating fluids could result in thermal shock as well as contamination effects.

2.2.5.1 Test item temperature.

Use a test item temperature representative of the materiel temperature when exposed to the contaminating fluid. For example, materiel to be de-iced will most likely be at or below freezing; materiel exposed to hydraulic leaks while on the tarmac may have surface temperatures above 50°C.

2.2.5.2 Test fluid temperature.

In most cases, use the temperature of the test fluid equal to its temperature during its most extreme operating condition. Design assessment may prove that other temperatures provide a more severe environment, e.g., longer exposure at lower temperatures because of slower evaporation. Table I includes worst-case test fluid temperatures.

2.2.5.3 Soak temperature.

In order for contamination effects to mature, a soak of the test item following contamination is necessary. The temperature of both the contaminating fluid and the materiel will, most likely, change during actual contamination situations. The post-contamination soak will not necessarily reflect the exposure scenario, but rather the worst-case effect(s) on the materiel. Accordingly, for the soak temperature, use the materiel's maximum life cycle temperature for the anticipated exposure situation.

2.2.6 Soak duration.

Unless otherwise justified, expose the contaminated test item to the required soak temperature (paragraph 2.2.5.3) for a minimum of 8 hours.

3. INFORMATION REQUIRED.

3.1 Pretest.

The following information is required to conduct contamination by fluid tests adequately.

- a. General. Information listed in Part One, paragraphs 5.7 and 5.9, and Appendix A, Task 405 of this standard.
- b. Specific to this method.
 - (1) The test fluid(s) to be used and its temperature.
 - (2) The method of test fluid application.
 - (3) The soak (post-wetting) temperature and duration.
 - (4) The cleaning/decontaminating fluids.
 - (5) The sequence of test fluid applications and post-test cleaning instructions.
 - (6) The type of exposure, i.e., occasional, intermittent, or extended.
 - (7) Any requirement for long term surveillance and inspections.
 - (8) Material properties, e.g., tensile strength, hardness, weight, dimensions, etc., of the material likely to be affected by the contaminating fluids.

3.2 During Test.

Collect the following information during conduct of the test:

- a. General. Information listed in Part One, paragraph 5.10, and in Appendix A, Task 406 of this standard.
- b. Specific to this method.

- (1) Record of chamber temperature versus time conditions.
- (2) Test fluid(s) and the corresponding temperature.
- (3) Any deterioration noted during visual checks.

3.3 Post Test.

The following post test information is required.

- a. General. Information listed in Part One, paragraph 5.13, and in Appendix A, Task 406 of this standard.
- b. Specific to this method.
 - (1) Results of each functional check after each exposure to each of the specified fluids.
 - (2) Any degradation of materials, protective finishes, etc. (see paragraph 3.1b(8)).
 - (3) Immersion times and exposure type.

4. TEST PROCESS.

4.1 Test Facility.

Use a test facility that includes an enclosure and a temperature control mechanism designed to maintain the test item at a specified temperature, as well as a means of monitoring the prescribed conditions (see Part One, paragraph 5.18). The contamination facility is a tank within the test enclosure (non-reactive with the contaminant) in which the test item is exposed to the selected contaminant by immersion, spraying, splashing, or brushing. Design the temperature control mechanism to maintain the test item at the specified temperature. When the flash point of the test fluid is lower than the test temperature, design the test facility in accordance with fire and explosion standards.

4.2 Controls.

Ensure the test and cleaning (decontaminating) fluids are handled and disposed of as required by local environmental and safety requirements. Some test fluid specifications are referenced in table 504-I.

4.3 Test Interruption.

- a. General. See Part One, paragraph 5.11, of this standard.
- b. Specific to this method.
 - (1) Undertest interruption. If an unscheduled test interruption occurs that causes the test conditions to exceed allowable tolerances toward standard ambient conditions, give the test item a complete visual examination and develop a technical evaluation of the impact of the interruption on the test results. Restart the test at the point of interruption and restabilize the test item at the test conditions.
 - (2) Overtest interruption. If an unscheduled test interruption occurs that causes the test conditions to exceed allowable tolerances away from standard ambient conditions, stabilize the test conditions to within tolerances and hold them at that level until a complete visual examination and technical evaluation can be made to determine the impact of the interruption on test results. If the visual examination or technical evaluation results in a conclusion that the test interruption did not adversely affect the final test results, or if the effects of the interruption can be nullified with confidence, restabilize the pre-interruption conditions and continue the test from the point where the test tolerances were exceeded. Otherwise, restart the test with a new test item.

4.4 Test Setup.

- a. General. See Part One, paragraph 5.8.
- b. Unique to this method. Ensure collection containers are available for each test fluid and waste fluids.

MIL-STD-810F
1 January 2000

4.5 Test Execution.

The following test procedure may be used to determine the resistance of the materiel to contaminating fluids. Conduct the functional checks after each exposure to each of the specified fluids.

4.5.1 Preparation for test.

4.5.1.1 Preliminary steps.

Before starting the test procedure, determine the test details (e.g., procedure variations, test item configuration, contaminating fluids, durations, parameter levels, etc.) from the test plan. (See paragraph 3.1 above.)

4.5.1.2 Pretest standard ambient checkout.

All test items require a pretest standard ambient checkout to provide baseline data. Examine munitions and other appropriate materiel by nondestructive examination methods. Conduct the checkout as follows:

- Step 1. Stabilize the test item at standard ambient conditions (Part One, paragraph 5.1).
- Step 2. Conduct a complete visual examination of the test item (evaluate against paragraph 2.1.1) with special attention to stress areas such as corners of molded areas and interfaces between different materials (e.g., component lead/ceramic interfaces of visible electronic parts), and document the results for comparison with post test data.
- Step 3. Conduct an operational checkout in accordance with the approved test plan and record the results.
- Step 4. If the test item operates satisfactorily, proceed to the next Step. If not, resolve the problems and restart at Step 1, above.
- Step 5. Prepare the test item in accordance with Part One, paragraph 5.8 and in the required test item configuration.

4.5.1.3 Cleaning.

If necessary and, unless otherwise specified, clean the test item to remove unrepresentative coatings or deposits of grease.

4.5.1.4 Multiple fluids.

If more than one contaminating fluid has been identified, determine if each is to be evaluated simultaneously or sequentially. If sequential testing is required, specify in the requirements document any necessary cleaning method between tests for different contaminants. Check the supplier's material safety data sheet for chemical compatibility.

4.5.2 Procedure.

- Step 1. With the test item in its required configuration (operational, storage, etc.), install it in the test facility. If appropriate, the configuration may include appropriate electrical or mechanical connections.
- Step 2. If appropriate, perform an operational check and record data for comparison with post test data.
- Step 3. Stabilize the test item at the appropriate temperature for the identified contamination scenario (see paragraph 2.2.5).
- Step 4. Stabilize the temperature of the specified fluid(s) to that determined from paragraph 2.2.5.2. If simultaneous application of more than one fluid is required, apply the fluid with the highest application temperature first, then the next highest, and so on until all required fluids have been applied^{5/}. If sequential, complete steps 4-9 for the first fluid. Apply the second fluid and repeat, etc.
 - a. For occasional contamination, apply the specified fluid(s) (e.g., dip, spray, etc.) to the entire surface of the test item that is likely to be exposed.
 - b. For intermittent contamination, apply the specified fluid(s) (e.g., dip, spray, etc.) to the entire surface of the test item that is likely to be exposed. Repeat this procedure one or more times as necessary to maintain all the test item surfaces in a wetted condition for the period specified in the requirements document. If not specified, subject the test item to three 24-hour

^{5/}Before mixing two or more fluids, ensure they are compatible and will not produce a hazardous reaction.

cycles, each cycle consisting of 8 hours in the wetted condition, followed by a drain period of 16 hours at the temperature specified in step 3.

- c. For extended contamination, immerse the test item in the specified fluid and maintain for the period specified in the requirements document. If not specified, use a fluid temperature as given in table I, and immerse the test item for at least 24 hours.
- Step 5. Allow the test item to drain naturally. Shaking or wiping is not permitted but, if representative of service conditions, it may be rotated about any axis to allow for drainage from different positions.
 - Step 6. Maintain the test item at the temperature determined in paragraph 2.2.5.3 for 8 hours (paragraph 2.2.6). Visually examine the test item for deterioration of any materials. If noted, consider stopping the test and evaluating the long term effects of completing the full exposure.
 - Step 7. If there is no obvious deterioration, continue step 6 for another 16 hours.
 - Step 8. Repeat steps 6 and 7 for two more 24-hour periods. See the paragraph 1.2 warning for material disposal guidance.
 - Step 9. Stabilize the test item at standard ambient conditions.
 - Step 10. Visually examine the test item for degradation of materials, protective finishes, and physical changes. Record results for comparison with data obtained in paragraph 3.1b(8).
 - Step 11. If appropriate, conduct a functional check of the test item similar to that in step 2 above and document the results for comparison with the pretest data.
 - Step 12. If specified, store the test item at standard ambient conditions to permit evaluation of any long term effects.

5. ANALYSIS OF RESULTS.

In addition to the guidance provided in Part One, paragraphs 5.14 and 5.17, any contamination effects must be analyzed for their immediate or potential (long-term) effects on the proper functioning of the test item. Satisfactory functioning immediately following this test is not the sole criterion for pass/fail.

6. REFERENCE/RELATED DOCUMENTS.

- a. Defence Standard 42-40, Foam Liquids, Fire Extinguishing (Concentrates, Foam, Fire Extinguishing), (UK Ministry of Defence).
- b. Defence Standard 68-161, Dispensers, Insecticide Aerosol Flying Insect Killer, (UK Ministry of Defence).
- c. Test Operations Procedure 3-2-609, Chemical Compatibility of Non-metallic Materials Used in Small Arms Systems; USATECOM, APG, MD 21005-5055.
- d. BS 6580: 1992, Specification for Corrosion Inhibiting, Engine Coolant Concentrate ('Antifreeze'), British Standards Institute.
- e. Defence Standard 79-17, Compound, Cleaning, Foaming, for Aircraft Surfaces, (UK Ministry of Defence).
- f. MIL-C-47220, Coolant Fluid, Dielectric Reviewer: 68 GS (U.S.).

MIL-STD-810F
1 January 2000

TABLE 504-I. Major contaminant fluid groups and test fluids.

| Contaminant Fluid Group | | Test Fluid*** | Test Fluid Temp.(±2°C) |
|-------------------------------------|-----------------------------------|--|------------------------|
| Fuels | Kerosene | Aviation turbine fuel (JP-4 (NATO F-40), JP-5 (NATO F-44), JP-8 (NATO F-34), etc.) | 70 |
| | Diesel | DL-A, DL-1, DL-2 (ASTM D975) | 23 |
| | Gasoline (Piston Engine) | ISO 1817, Test liquid B; ASTM 4814, Automotive spark ignition engine | 40* |
| Hydraulic oils | Mineral oil based | NATO H-520/NATO H-515; U.S. MIL-H-5606 | 70 |
| | Phosphate ester based (synthetic) | ISO 1817, test liquid 103; U.S.: MIL-H-46170 (FRH); NATO: H-544 | 70 |
| | Silicone based | Dimethyl silicone (ZX42; NATO S1714) | 70 |
| Lubricating oils | Mineral based | NATO 0-1176 (OMD 80); NATO Stock #4210 99 224 8369 | 70 |
| | Internal Combustion Engine | MIL-PRF-2104, 15W40 (NATO D-1236) | 70 |
| | Ester based (synthetic) | ISO 1817, test liquid 101 | 150 |
| Solvents & cleaning fluids | | Propan-2-ol (isopropyl alcohol) | 50* |
| | | Denatured alcohol | 23* |
| | | Cleaning compound for aircraft surfaces | 23 |
| Deicing & antifreeze fluids | | Inhibited ethylene glycol (BS 6580) 80% and 50% solution in water (v/v); U.S. antifreeze: AA-52624 (NATO S-750) | 23 |
| Runway de-icers | | 25% urea/25% ethylene glycol in water (v/v)** | 23 |
| Insecticides | | Insecticides | 23 |
| Disinfectant (Heavy duty phenolics) | | Clear, soluble phenolics, e.g., phenol or its derivatives dissolved in a surfactant and diluted with water to give a clear solution. | 23 |
| | | Black fluids, e.g., refined tar products dissolved in a carrier oil and emulsified with detergent. | |
| | | White fluids, e.g., colloidal emulsions of refined coal tar products in water, usually containing a small amount of surfactant. | |
| Coolant dielectric fluid | | PAO dielectric | 70 |
| Fire extinguishants | | Protein: NATO Stock #4210 99 224 6855 | 23 |
| | | Fluoroprotein: NATO Stock #4210 99 224 6854 | 23 |

* Exceeds the critical flash point temperature; obtain expert advice.

** Subject to change; identified as environmental hazard.

*** See Annex A for further information.

ANNEX A

ENVIRONMENTAL AND TOXICOLOGICAL CONSIDERATIONS

1. Gasoline fuels and mineral/synthetic oils.

- a. Open burning will produce environmental pollution.
- b. Contact with the skin will promote de-fatting.
- c. Ignition under certain circumstances will cause explosion.
- d. Low flash point of gasoline (piston engine): -18°C .
- e. Spillage can cause contamination of waterways and underground water supplies. Three hundred liters of gasoline has the capacity to produce a surface film over one square kilometer of still water.
- f. Carcinogenic chemicals such as benzene are present in fuels; oils often contain other toxic ingredients.
- g. Tri alkyl phosphate is a typical synthetic hydraulic oil. Spillage can cause toxic pollution of waterways and underground water supplies.

2. Solvents and cleaning fluids.

- a. Propan-2-ol is flammable.
- b. 1.1.1 Trichloroethane is currently being withdrawn from use because of its environmental impact when reacting with ozone. It is also believed to have mutagenic properties.
- c. Denatured alcohol is both toxic and flammable. It is a mixture containing approximately 95% ethyl alcohol, 5% methyl alcohol, and minor ingredients such as pyridine.
- d. Detergent made from biodegradable phosphates sodium sulfate and sodium carboxy methyl cellulose is a conventional laundry substance. Untreated discharge into waterways must be avoided.

3. De-icing and anti freeze fluids.

- a. All aqueous solutions of ethylene glycol are toxic and the inclusion of 25% urea will promote the growth of algae.
- b. 50% inhibited aqueous potassium acetate solution is commercially marketed and reputed to be a completely safe new alternative to the ethylene glycols. However, its interaction with aluminum alloys is less than satisfactory.

4. Disinfectant.

Formulations containing formaldehyde and/or homologues of phenol (often derived from coal-tar products) are used extensively in chemical toilets, disinfectant of toilet seats, sinks, and work surfaces. Disinfectants can blister the skin; if toxic, they may cause poisoning by absorption through the skin or by inhalation of the vapors. Undiluted forms of certain disinfectants may be flammable. Expert commercial disposal companies should manage disposal of detergents. Small quantities may be flushed down the drain with copious quantities of water.

5. Coolant dielectric fluid.

- a. Coolanol 25R is a silicate ester, which can be hydrolysed to produce flammable products. The U.S. has withdrawn it from use.
- b. The most recent coolants are based on polymerised alpha olefines, which are both non-toxic and generally inert.

MIL-STD-810F
1 January 2000

6. Fire extinguishants.

The propellant gases currently used to produce foaming are chloro fluoro hydrocarbons (CFC's). These react with ozone and are therefore environmentally destructive.

7. Insecticides.

Most insecticides may be regarded as toxic to man. If the delivery vehicle for the insecticide is a kerosene-type (fuel/oil) spray or mist, many of the features identified under paragraph 1 above will also apply.

METHOD 505.4

SOLAR RADIATION (SUNSHINE)

NOTE: Tailoring is essential. Select methods, procedures, and parameter levels based on the tailoring process described in Part One, paragraph 4.2.2, and Appendix C. Apply the general guidelines for laboratory test methods described in Part One, paragraph 5 of this standard.

1. SCOPE.

1.1 Purpose.

This method has two purposes:

- a. To determine the heating effects of direct solar radiation on materiel.
- b. To help identify the actinic (photodegradation) effects of direct solar radiation.

1.2 Application.

Use this method to evaluate materiel likely to be exposed to solar radiation during its life cycle in the open in hot climates, and when heating or actinic effects are of concern. Limit use of this method to evaluating the effects of direct exposure to sunlight (solar spectrum and energy levels at sea level). Although not intended for such, Procedure II may be used to simulate the ultraviolet effect of solar radiation of different locations and altitudes by using various radiation sources that allow reasonable comparison to measurements of these natural solar radiation conditions.

1.3 Limitations.

- a. This test method does not consider all of the effects related to the natural environment (see Annex A, paragraph 7.2) and, therefore, it is preferable to test materiel at appropriate natural sites. Use this method when the spectrum of the lamp bank has been measured and conforms to the spectrum identified in table 505.4-I. Deviations from this table may be justified if the test requirements are based on the tailoring process, or if a specific frequency band is of concern. Detail and justify any deviation.
- b. This method does not simulate uniform heating that occurs in enclosed environments or indirect heating in shaded areas, or in covered storage conditions (see method 501.4, High Temperature).
- c. Due to the possible change in irradiance, this method is not intended to be used for space applications.

2. TAILORING GUIDANCE.

2.1 Selecting this Method.

After examining requirements documents and applying the tailoring process in Part One of this standard to determine where solar radiation effects are foreseen in the life cycle of the test item, use the following to confirm the need for this method and to place it in sequence with other methods.

2.1.1 Effects of solar radiation environments.

2.1.1.1 Heating effects.

The heating effects of solar radiation differ from those of high air temperature alone in that solar radiation generates directional heating and thermal gradients. In the solar radiation test, the amount of heat absorbed or reflected depends primarily on the roughness and color of the surface on which the radiation is incident. If a glazing system

MIL-STD-810F
1 January 2000

is part of the test item configuration, and the component of concern is exposed to solar energy that has passed through the glazing system, use a full spectrum source if the glazing system is attenuating the infrared portion of the spectrum. In addition to the differential expansion between dissimilar materials, changes in the intensity of solar radiation may cause components to expand or contract at different rates, which can lead to severe stresses and loss of structural integrity. In addition to those identified in method 501.4, consider the following typical problems to help determine if this method is appropriate for the materiel being tested. This list is not intended to be all-inclusive.

- a. Jamming or loosening of moving parts.
- b. Weakening of solder joints and glued parts.
- c. Changes in strength and elasticity.
- d. Loss of calibration or malfunction of linkage devices.
- e. Loss of seal integrity.
- f. Changes in electrical or electronic components.
- g. Premature actuation of electrical contacts.
- h. Changes in characteristics of elastomers and polymers.
- i. Blistering, peeling, and delamination of paints, composites, and surface laminates applied with adhesives such as radar absorbent material (RAM).
- j. Softening of potting compounds.
- k. Pressure variations.
- l. Sweating of composite materials and explosives.
- m. Difficulty in handling.

2.1.1.2 Actinic effects.

In addition to the heating effects of paragraph 2.1.1.1, certain degradation from solar energy may be attributable to other portions of the spectrum, particularly the ultraviolet. Since the rate at which these reactions will occur generally increases as the temperature rises, use the full spectrum to adequately simulate the actinic effects of solar radiation. The following are examples of deterioration caused by actinic effects. The list is not intended to be comprehensive.

- a. Fading of fabric and plastic color.
- b. Checking, chalking, and fading of paints.
- c. Deterioration of natural and synthetic elastomers and polymers through photochemical reactions initiated by shorter wavelength radiation. (High strength polymers such as Kevlar are noticeably affected by the visible spectrum. Deterioration can be driven by breakage of high-order bonds (such as pi and sigma bonds existing in carbon chain polymers) by radiation exposure.)

2.1.2 Sequence among other methods.

- a. General. See Part One, paragraph 5.5.
- b. Unique to this method. Generally, consider applying the solar radiation test at any stage in the test program. However, high temperatures or actinic effects could affect material's strength or dimensions that could affect the results of subsequent tests such as vibration.

2.2 Selecting Procedures.

This method includes two test procedures, Procedure I (Cycling (thermal effects)) and Procedure II (Steady State (actinic effects)). Determine the procedure(s) to be used. Either procedure may be used to determine actinic effects, but procedure II reduces the test duration.

2.2.1 Procedure selection considerations.

When selecting procedures, consider:

- a. The operational purpose of the test item. Physical degradation that occurs during exposure may produce adverse effects on materiel performance or reliability. Based on the purpose of the materiel, determine functional modes and test data needed to evaluate the performance of the test item during and after exposure to solar radiation.
- b. The anticipated areas of deployment.
- c. The test item configuration.
- d. The anticipated exposure circumstances (use, transportation, storage, etc.).
- e. The expected duration of exposure to solar radiation.
- f. The expected problem areas within the test item.

2.2.2 Difference between procedures.

While both procedures involve exposing test items to simulated solar radiation, they differ on the basis of timing and level of solar loads, and the focus of the procedure (analyzing heat versus actinic effects). Procedure I (Cycling (thermal effects)) focuses on the effects of heat produced by solar radiation, exposing materiel to continuous 24-hour cycles of simulated solar radiation (or thermal loading) at realistic maximum levels typical throughout the world. Procedure II (Steady State (actinic effects)) is designed to accelerate photo degradation effects produced by solar radiation. This procedure exposes materiel to cycles of intensified solar loads (approximately 2.5 times normal levels) interspersed with dark periods to accelerate actinic effects that would be accumulated over a longer period of time under normal solar loads. Actual acceleration ratios are material dependent, and 2.5 times the natural solar exposure may not provide equal acceleration. This could, however, provide a more rapid test provided the failure mechanisms follow the path expected in the real environment.

- a. Procedure I – Cycling (heating effects). Use Procedure I to investigate response temperatures when materiel is exposed in the open in realistically hot climates and is expected to perform without degradation during and after exposure. Although Procedure I can be performed using simple heat-generating lamps, limited evaluation of actinic effects is possible if Procedure II lamps are used instead. It is preferable to use the solar radiation test (as opposed to the High Temperature test, method 501.4) when the materiel could be affected by differential heating (see paragraph 2.1.1.1) or when the levels or mechanisms of heating caused by solar radiation are unknown (this encompasses almost all materiel). Only materials that are of the same or like color and structure should be analyzed using an infrared source. If a glazing system is incorporated in the materiel, verify that the infrared transmission is not affected when using an infrared source. Otherwise, use a full spectrum source. It is critical to maintain the minimum airflow necessary to control the required air temperature at the test item.
- b. Procedure II – Steady State (actinic effects). Use Procedure II to investigate the effects on materiel of long periods of exposure to sunshine. Actinic effects usually do not occur until materiel surfaces receive large amounts of sunlight (as well as heat and moisture). Therefore, it is inefficient to use the repeated, long cycles of normal levels of solar radiation (as in Procedure I) to generate actinic effects. Using Procedure I for this purpose could take months. The approach, therefore, is to use an accelerated test that is designed to reduce the time to reproduce cumulative effects of long periods of exposure.
 - (1) The key to using Procedure II successfully is maintaining enough cooling air to prevent the test item from exceeding temperatures that would be attained under natural conditions. However, do not use

MIL-STD-810F
1 January 2000

so much cooling air that it produces unrealistic cooling. This implies that before this test can be performed, the maximum temperature response the materiel would experience under natural conditions (by using field/fleet data or as determined by running Procedure I) must be known. If Procedure I has not been performed previously and no field/fleet data are available, recommend a preliminary test be carried out in accordance with Procedure I (absolute minimum of one complete cycle) to determine the approximate maximum response temperature of the test item. If it is practical, conduct this preliminary test on the entire test item; if not, use a coupon which is representative of the test item's actual color, surface roughness, degree of insulation (any internal heating will need to be simulated), etc. Use this preliminary coupon test to determine only the approximate maximum temperature response of the test item, not to replace either Procedure I or Procedure II. Similarly, if multiple and identical test items are to be tested, use one or more of the items for the preliminary test to determine the maximum temperature response. Since actinic effects are highly dependent upon the solar radiation spectrum (as well as intensity and duration), the spectrum must be as close as possible to that of natural sunlight. Temperature measurement techniques must be agreed by the parties involved.

- (2) The 4-hour "lights-off" period of each 24-hour cycle allows for test item conditions (physical and chemical) to return toward "normal" and provide some degree of thermal stress exercising.

2.3 Determine Test Levels and Conditions.

Having selected this method and relevant procedures (based on the materiel's requirements documents and the tailoring process), complete the tailoring process by identifying appropriate parameter levels, special test conditions and techniques for these procedures such as the diurnal cycle, test duration, test item configuration, relative humidity, and any additional appropriate conditions. Base these test parameter levels on the requirements documents, Life Cycle Environmental Profile, Operational Environment Documentation (see Part One, figure 1-1), and information provided with this method. Consider the following in light of the operational purpose and life cycle of the materiel.

2.3.1 Diurnal cycle.

For Procedure I, there are three high temperature diurnal cycles included that correspond to the maximum meteorological conditions in the three climatic categories, A1, A2, and A3 of MIL-HDBK-310. Although usually not as significant, in addition to these climatic categories, consider marine environments (M1 and M2 in STANAG 2895) as appropriate in the life cycle profile. Figure 505.4-1 shows the daily cycles of temperature and solar radiation corresponding to categories A1-A3 for Procedure I. Choose the conditions for the test according to the planned climatic categories for use of the materiel:

- a. Worldwide deployment. Cycle A1 has peak conditions of 1120 W/m² (355 BTU/ft²/hr) and 49°C (120°F), and represents the hottest conditions exceeded not more than one percent of the hours in the most extreme month at the most severe locations that experience very high temperatures accompanied by high levels of solar radiation, namely, hot, dry deserts of north Africa, parts of the Middle East, northern India, and the Southwestern USA.
- b. Cycle A2 has peak conditions of 1120 W/m² and 44°C (111°F) and represents less severe conditions at locations that experience high temperatures accompanied by high levels of solar radiation and moderately low humidity, namely, the most southerly parts of Europe, most of the Australian continent, south central Asia, northern and eastern Africa, coastal regions of north Africa, southern parts of the USA, and most of Mexico. Use this cycle when the materiel is to be used only in geographical locations described in categories A2 or A3, but not in category A1.
- c. Cycle A3 has peak conditions of 1120 W/m² and 39°C (102°F) and represents only those locations which experience moderately high temperatures and moderately low humidity for at least part of the year. It is particularly representative of conditions in Europe except the most southern parts, Canada, the northern USA, and the southern part of the Australian continent. However, for the purposes of this document, category A3 is considered to apply to all land masses except those designated as category A1 or A2. Use this cycle when the materiel is to be used only in the geographical locations described in category A3 but

not category A1 or A2. Figure 505.4-2 shows the corresponding temperature and solar radiation levels for Procedure II.

2.3.2 Test duration.

- a. Procedure I. Expose the test item to continuous 24-hour cycles of controlled simulated solar radiation and dry bulb temperature as indicated on figure 505.4-1 or as identified in the requirements documents. A goal of this test is to establish the highest temperature that the test item will reach during repeated cycles. In many cases three cycles are adequate to establish this maximum temperature. Perform at least three continuous cycles. The variation in solar energy may be applied continuously or incrementally, with a minimum of four levels (preferably eight levels) for each side of the cycle, provided that the total energy of the cycle is maintained. If the maximum temperature is not reached (within 2°C (3.6°F) of the peak response temperature achieved during the previous 24-hour cycle) during the three cycles, perform four to seven cycles. Stop the test when the maximum test item temperature is established or at the end of the seventh cycle. In the absence of other guidance, recommend the maximum test duration of seven cycles because the peak high temperature for the selected climatic region occurs approximately seven hours in the most extreme month. If more exact simulation is required, meteorological data for the particular areas under consideration should be consulted. This may include adjustment of solar energy, if appropriate, to account for latitude, altitude, month of anticipated exposure, or other factors (for example, a product exclusively used in northern areas, or exclusively used in winter months). Any deviation from the standard conditions must be detailed and justified.
- b. Procedure II. Procedure II produces an acceleration factor of approximately 2.5 as far as the total energy received by the test item is concerned, i.e., one 24-hour cycle as shown on figure 505.4-2 provides approximately 2.5 times the solar energy experienced in one 24-hour (natural) diurnal cycle plus a 4-hour lights-off period to allow for alternating thermal stressing and for the so-called "dark" processes to occur. To simulate 10 days of natural exposure, for instance, perform four 24-hour cycles as shown on figure 505.4-2. Recommend a duration of ten 24-hour cycles (as on figure 505.4-2) for materiel which is occasionally used outdoors, such as portable test items, etc. For materiel continuously exposed to outdoor conditions, recommend a test duration of 56 24-hour cycles or longer. Do not increase the irradiance above the identified level because of the danger of overheating; there is presently no indication that attempting to accelerate the test in this way gives results that correlate with materiel response under natural solar radiation conditions.

2.3.3 Humidity.

While various levels of relative humidity occur naturally, and humidity combined with temperature and solar radiation can, in many cases, have deleterious effects on materiel. If the materiel is known or suspected to be sensitive to RH, include it in the Procedure I test requirements. STANAG 2895 and MIL-HDBK-310 have temperature-humidity data for various regions of the Earth.

2.3.4 Configuration.

Use the same test item configuration as during exposure to natural solar radiation. The orientation of the test item relative to the direction of radiation will have a significant impact on the heating effects. In cases where several test item components are already known to be sensitive to solar effects, adjust the relative test item/solar radiation source orientation to simulate a natural diurnal cycle. Whenever possible, mount the test item so that its configuration is representative of actual deployment, as provided in the requirements document. This mounting may include supports or a substrate of specified properties (e.g., a layer of concrete of specified thickness or a sand bed of certain reflectivity).

2.3.5 Spectral distribution - Sea level versus high ground elevations.

At high ground elevations solar radiation contains a greater proportion of damaging UV radiation than at sea level. Although the internationally agreed spectrum shown in table 505.4-I is recommended for general testing, it is a closer representation of the real environment at 4-5 km above sea level. This standard spectrum may be used (unless other data are available) for both sea level and high ground elevation. If testing for sea level conditions using the

MIL-STD-810F
1 January 2000

data in table 505.4-I, degradation during the test may be expected to proceed at a faster rate than if using the appropriate spectrum for sea level, and laboratory test exposure periods should be modified accordingly.

2.3.6 Temperature.

In addition to the temperature guidance given elsewhere in this method, it is essential to maintain the air temperature in the vicinity of the test item to that temperature specified as the test area ambient air temperature. To do so requires necessary airflow and air temperature measurement (sensors shielded from radiation) in the immediate vicinity of the test item.

2.4 Test Item Operation.

When it is necessary to operate the test item, use the following guidelines for establishing test operating procedures.

- a. General. See Part One, paragraph 5.8.2.
- b. Unique to this method.
 - (1) Include operating modes that consume the most power (generate the most heat).
 - (2) Include the required range of input voltage conditions, if changes in voltage could affect the test item thermal dissipation or response (e.g., power generation or fan speed).
 - (3) Introduce any cooling media that normally would be applied during service use (e.g., forced air or liquid coolant). Consider using cooling medium inlet temperatures and flow rates that represent both typical and worst-case degraded temperature and flow conditions.

3. INFORMATION REQUIRED.

3.1 Pretest.

The following information is required to conduct solar radiation tests adequately.

- c. General. Information listed in Part One, paragraphs 5.7 and 5.9, and Appendix A, Task 405 of this standard.
- d. Specific to this method.
 - (1) Appropriate diurnal cycle (for Procedure I) to include humidity if appropriate.
 - (2) Test item operational requirements.
 - (3) Spectral radiation of the source lighting (e.g., to reproduce conditions of a previous test).
 - (4) Any additional guidelines.
 - (5) Temperature measurement techniques.

3.2 During Test.

Collect the following information during conduct of the test:

- a. General. Information listed in Part One, paragraph 5.10, and in Appendix A, Task 406 of this standard.
- b. Specific to this method.
 - (1) Record of chamber temperatures and light intensity versus time conditions.
 - (2) Record of the test item temperature-versus-time data for the duration of the test.

3.3 Post-test.

The following post-test information is required.

- a. General. Information listed in Part One, paragraph 5.13, and in Appendix A, Task 406 of this standard.
- b. Specific to this method.
 - (1) Location of temperature sensors on the test item.
 - (2) Test item temperatures and exposure periods.
 - (3) Solar lamp bank identification.
 - (4) Any additional data required.

4. TEST PROCESS.

4.1 Test Facility.

- a. The required facility consists of a chamber or cabinet, auxiliary instrumentation, and a solar lamp bank. This apparatus must be capable of maintaining and monitoring (see Part One, paragraph 5.18) the required conditions of temperature, airflow, and irradiation.
- b. For both procedures consider the possible cooling effects of airflow over the test specimens. An airflow of as little as 1 m/s can cause a reduction in temperature rise of over 20 percent. Unless otherwise justified, control and measure the rate of airflow in the vicinity of the test item such that it is as low as possible consistent with achieving satisfactory control of the ambient air temperature at the test item, i.e., usually between 0.25 and 1.5 m/s (50 to 300 ft/min).
- c. To minimize or eliminate re-radiation from chamber surfaces, experience has shown that the best method is when the volume of the test chamber is a minimum of 10 times that of the envelope volume of the test item. (Consider the beam angles of the light source hitting the walls of the test chamber.)

4.1.1 Substrate.

The test item should be mounted either on raised supports or on a substrate of specified properties, e.g., a layer of concrete of specified thickness or a sand bed of a conductivity and reflectivity representative of actual deployment, as provided in the requirements documents.

4.1.2 Solar radiation source.

- a. Compose the solar radiation source of either radiant heat-producing lamps (for Procedure I) or lamps that simulate the solar spectrum (for Procedure II or both I and II). The radiation intensity of the light source array must not vary by more than 10% from the desired value as measured on the upper surface of the test item.
- b. Use a maximum irradiance intensity of 1120 W/m^2 ($\pm 47 \text{ W/m}^2$) and ensure the radiation on the test item is uniform to within 10% of the desired value. Where actinic effects are to be assessed, ensure the spectral distribution of the light source adheres to the distribution given in table 505.4-I (within the given tolerances). Where only thermal effects are being assessed, it is desirable to maintain at least the visible and infrared portions of the spectrum as in table 505.4-I. However, if not feasible, deviate from the spectral distribution (table 505.4-I) as necessary, but adjust the irradiance to give an equivalent heating effect. In order to determine the amount of adjustment necessary, employ either of two methods:
 - (1) Mathematically calculate the adjustment using the following information:
 - (a) The spectral reflectance or transmittance of the irradiated surfaces, and
 - (b) The spectral energy distribution of the particular lamps being used (and also the effect of any associated reflectors or glasses).

MIL-STD-810F
1 January 2000

- (2) Empirically determine the adjustment by conducting a pre-test on samples which are representative of the materiel (the most important characteristics are color and surface roughness). Measure the temperature rise above ambient air temperature of test samples under natural solar radiation conditions and compare the results with the temperature rise above ambient (chamber) air temperature of test samples under simulated solar radiation. Gather enough data under the natural condition portion of the test to account for the cooling effects of airflow over the samples (i.e., outdoor conditions rarely provide zero wind), and extrapolate the temperature rise at zero wind conditions to be comparable to results from chamber samples).

TABLE 505.4-I. Spectral energy distribution and permitted tolerance.

| CHARACTERISTIC | SPECTRAL REGION | | | |
|----------------|------------------------------------|-----------------------------------|----------------------|----------------------|
| | ULTRAVIOLET | | VISIBLE | INFRARED |
| Bandwidth | 0.28 μ m to 0.32 μ m | 0.32 μ m to 0.4 μ m | 0.40 to 0.78 μ m | 0.78 to 3.00 μ m |
| Irradiance | 5W/m ² | 63W/m ² | 560W/m ² | 492W/m ² |
| Tolerance | \pm 35% | \pm 25% | \pm 10% | \pm 20% |

NOTE: The amount of radiation wavelength shorter than 0.30 μ m reaching the Earth's surface is small but the effect on the degradation of material can be significant. Short wavelength energy below 300 nm can cause materials to fail unnecessarily (if not present in the natural exposure). In reverse, if energy below 300 nm is present in the natural environment and not present in the accelerated exposure, material that should fail may pass the test. This is entirely material dependent because it relates to the end use in natural exposure. (See Annex A, paragraph 2.2.)

- a. Direct the radiation onto the test item and irradiate the entire surface of the test item facing the solar radiation source. To provide the highest degree of confidence in the measurements, the value of 1120W/m² theoretically includes all radiation received by the test item, including any radiation reflected from the chamber walls and any long-wave infrared radiation (but not greater than 3 μ m) emitted by the chamber walls. To accomplish this, the radiation-measuring device would have to be calibrated in a wavelength range wide enough to encompass the wavelength ranges of both the light source and the long-wave infrared radiation emitted by the chamber walls. However, radiation reflected or emitted from the chamber walls is generally substantially lower than the radiation emitted directly from the light source, and a measurement device that has a measurement range of 285-2800 nm should be sufficient to measure direct and reflected radiation. Accordingly, if the intent of the test is to determine actinic effects, use a radiation-measuring device that is calibrated at least in the full wavelength range of the light source. Additionally, if the intent of the test is to determine thermal heat loading (see paragraph 4.1e), use any radiation measuring device which has some capability to measure infrared energy and calibrate the radiation measuring device in the full wavelength range it is designed to measure.
- b. To prevent localized effects such as unintentional heating from individual bulbs, locate the radiation source at least 76cm (30 inches) away from any surface of the test item. Spot lamps (as opposed to flood lamps) may produce a non-uniform exposure. Avoid the use of multiple lamp types within the array because the spectral distribution within the array will likely be non-uniform over the exposure area.
- c. Light source. The following lists (both sections (1) and (2)) are not intended to exclude new lamps made available by advanced technology. It may be necessary to use filters to make the spectrum comply with that specified in table 505.4-I. Further guidance is given in Annex A
 - (1) Tests conducted for degradation and deterioration of materials due to actinic effects as well as heat buildup within the test items must satisfy the full spectrum of table 505.4-I and may use one of the following acceptable radiation sources:
 - (a) Metal halide lamps (designed for full spectrum application).

- (b) Xenon arc or mercury xenon arc (used singularly) with suitable reflector.
- (c) Combination of high pressure sodium vapor and improved mercury vapor with suitable reflectors.
- (d) High-intensity multi-vapor, mercury vapor (with suitable reflectors), and incandescent spot lamps.
- (e) Carbon arc (with suitable filters).

NOTE: Use other combinations of the lamps listed above and in paragraph 4.1h (2) below if it is proven that the combination produces the spectrum of table 505.4-I.

- (2) Use the appropriate lamps from the following list for tests conducted to assess heating effects alone (and not actinic effects).
 - (a) Mercury vapor lamps (internal reflector type only).
 - (b) Combination of incandescent spot and tubular-type mercury vapor lamps w/ external reflectors.
 - (c) Combination of incandescent spot lamps and mercury vapor lamps with internal reflectors.
 - (d) Metal halide.
 - (e) Xenon arc or mercury xenon arc lamps with suitable reflectors.
 - (f) Multi-vapor (clear or coated bulb) with suitable reflectors.
 - (g) Tungsten filament lamps.
 - (h) Any other heat producing lamp (see paragraph 4.1e)

4.2 Controls.

- a. Temperature. Maintain the chamber air temperature (as specified in the test plan) in accordance with Part One, paragraph 5.2a. In order to adequately measure the temperature of the air surrounding the test item, measure it (with adequate shielding from radiated heat) at a point or points in a horizontal reference plane at the approximate elevation of the upper surface of the test item, and as close as possible to the test item, making adequate provision for shielding from the effects of radiant heat from the test item. This is one way to ensure reasonable control of the envelope of air surrounding the test item. The temperature sensors used to measure the thermal response of the test item will also be affected by direct radiation of the light source. When practical, mount these sensors to the inside surface of the external case (upper surface) of the test item.
- b. Surface contamination. Dust and other surface contamination may significantly change the absorption characteristics of irradiated surfaces. Unless otherwise required, ensure the test items are clean when they are tested. However, if the effects of surface contamination are to be assessed, include in the relevant requirements document the necessary information on preparation of surfaces.
- c. Instrumentation. Use a pyranometer, pyrheliometer or other suitable device to measure the total radiated energy imposed on the test item. Use a pyranometer with suitable filters or a spectroradiometer to measure the spectral distribution of the radiation imposed on the test item. A filtered pyranometer can only provide an approximate measurement of the spectral distribution. However, a spectroradiometer, although more delicate to employ, can provide a precise measurement of the spectral distribution. Use other measuring instruments only if they can satisfy the required specifications. Refer to the table below for the required measurement accuracy of these commonly used instruments. For a pyranometer, the following applies¹:

Spectral Range: 280 – 2,500 (better 3,000) nm
 Directional Error (cosine error): < +/-1%
 Non Linearity: <1.5%
 Tilt Effect (use at tilted surfaces): <1.5%
 Operating temperature: -40C to +80C
 Temperature dependence of sensitivity: +/-2% (-10C to +40C)

¹ These requirements correspond to a ISO 9060 secondary standard instrument as manufactured by several well-known manufacturers.

MIL-STD-810F
1 January 2000

TABLE 505.4-II. Instrument accuracy.

| Measurement Instrument | Parameter Measured | Tolerance |
|--|---|----------------------|
| Pyranometer/Pyrheliometer | Total irradiation (direct and scattered) | $\pm 47\text{W/m}^2$ |
| Spectroradiometer or Filtered Pyranometer | Spectral distribution | $\pm 5\%$ of reading |

NOTE: Values shown represent plus or minus two standard deviations; thus, do not exceed the stated tolerances in more than 1 measurement out of 20. Measure solar radiation intensity with a pyranometer or pyrheliometer. Measure spectral distribution of irradiance as a function of wavelength with a spectral radiometer or filtered pyranometer.

- d. Calibration of chamber. Because of the variety of permissible lamps and chamber designs, it is particularly important that the chamber be calibrated to assure the proper levels of radiant infrared energy are impacting the test area when heat alone is of concern, and that the proper intensity and spectral distribution of solar radiation are impacting the test area when actinic effects are of concern. If the test item is not available at the time the chamber is being calibrated, ensure the radiation intensity is within 10% of the desired value when measured over the area covered by the test item, at a horizontal reference plane at the approximate elevation of the upper surface position of the test item. If the test item is available at the time the chamber is being calibrated, ensure the radiation intensity is within 10% of the desired value when measured over the upper surface of the test item. As most types of lamps age, their spectral output changes. To ensure that solar radiation chambers meet established specifications, perform a thorough check on spectral distribution, intensity, and uniformity at intervals not exceeding 500 hours of operation. This value is based on the manufacturer's guarantee for minimum bulb life. Conduct a check of the overall intensity and uniformity (which is much easier) before and after every test.

4.3 Test Interruption.

- a. General. See Part One, paragraph 5.11, of this standard.
- b. Specific to this method.
- (1) Undertest interruption.
 - (a) Procedures I and II. The test rationale is based on the total cumulative effect of the solar environment. Except as noted in (b) below, follow any undertest interruption by restabilization at the identified levels and continuation of the test from the point of the interruption.
 - (b) Procedure I. The test is considered complete if an interruption occurs after 19 hours of the last cycle of procedure I. (At least 92 percent of the test would have been completed, and the probability of a failure is low during the remaining reduced levels of temperature and solar radiation.)
 - (2) Overtest interruption. Follow any overtest conditions by a thorough examination and checkout of the test item to verify the effect of the overtest. Since any failure following continuation of testing will be difficult to defend as unrelated to the overtest, use a new test item and restart the test at the beginning.

4.4 Execution.

The following steps, alone or in combination, provide the basis for collecting necessary information concerning the test item in a solar radiation environment.

4.4.1 Preparation for test.

4.4.1.1 Preliminary steps.

Before starting the test, review pretest information in the test plan to determine test details (e.g., procedures, item configuration, cycles, durations, parameter levels for storage/operation, etc.). (See paragraph 3.1, above.)

- a. Which test procedures are required.
- b. The diurnal cycle to be used.
- c. Other variables, such as number of cycles, etc.
- d. Degree of removal of surface contamination necessary (see paragraph 4.2b).
- e. Comparative information. For eventual comparison between pre- and post-test items, photograph the test item and take material samples (if required).

4.4.1.2 Pretest standard ambient checkout.

All items require a pretest standard ambient checkout to provide baseline data. Conduct the checkout as follows:

- Step 1. Install the test item in the chamber and stabilize it at standard ambient conditions (Part One, paragraph 5.1a) and in a manner that will simulate service use, unless the storage configuration is specified. Position the test item in accordance with the following:
 - a. As near the center of the test chamber as practical and so that the surface of the item is not closer than 0.3m (1 ft) to any wall or 0.76m (30 in.) to the radiation source when the source is adjusted to the closest position it will assume during the test
 - b. Oriented, within realistic limits, to expose its most vulnerable parts to the solar radiation, unless a prescribed orientation sequence is to be followed.
 - c. Separated from other items that are being tested simultaneously, to ensure that there is no mutual shading or blocking of airflow unless this, also, is representative of the test item's field use.
- Step 2. Conduct a visual examination of the test item with special attention to stress areas, such as corners of molded cases, and document the results.
- Step 3. Prepare the test item in accordance with Part One, paragraph 5.8, and in the identified test item configuration (see paragraph 2.3.3), with any temperature sensors necessary to determine test item response.
- Step 4. Conduct an operational checkout in accordance with the test plan and record the results.
- Step 5. If the test item operates satisfactorily, place it in its test configuration (if other than operational). If not, resolve the problem and restart at Step 1. Return the test item to the position identified in Step 1 and proceed to the first test as identified in the test plan.

4.4.2 Procedure I.

- Step 1. Adjust the chamber air temperature to the minimum value of the temperature cycle at which radiation is nonexistent.
- Step 2. Expose the test item to continuous 24-hour cycles of controlled simulated solar radiation and dry-bulb temperature as indicated on figure 505.4-1 or as identified in the requirements document, measuring and recording test item temperatures throughout the exposure period. For convenience and if the test facility is unable to perform the continuous curve of figure 505.4-1, to approximate the curve increase and decrease the solar radiation intensity in a minimum of four levels (preferably eight levels) for each side of the cycle, provided that the total energy of the cycle as well as the spectral power distribution (table 505.4-I) is maintained. Perform the longer of the following number of cycles:

MIL-STD-810F
1 January 2000

- a. The minimum necessary to ensure the peak response temperature of the most critical area of the test item achieved during a cycle is within 2°C of the peak response temperature achieved during the previous 24-hour cycle, or
 - b. Three continuous cycles, or
 - c. The number of cycles as identified by the requirements document (not to exceed 7 cycles).
- Step 3. The test item may or may not be operated throughout the test, at the option of the requirements document. If operation is required, operate the test item when the peak cycle temperature occurs. For some single-use items (e.g., rockets), use thermocouples affixed to critical portions of the test item to determine the time and value of peak temperature. Operate the test item at the peak cycle temperature. Conduct the operational checkout of the test item as in paragraph 4.4.1.2, Step 4. Document the results.
- Step 4. Adjust the chamber air temperature to standard ambient conditions and maintain until temperature stabilization of the test item has been achieved.
- Step 5. Conduct a complete visual examination of the test item and document the results. For comparison between pre- and post-test items, photograph the test item and take material samples (if required).
- Step 6. Conduct an operational checkout of the test item as in paragraph 4.4.1.2, Step 4.
- Step 7. Compare these data with the pretest data.

4.4.3 Procedure II.

- Step 1. Adjust the chamber air temperature to 49°C or the temperature identified in the test plan.
- Step 2. Adjust the solar radiation source to a radiant energy rate of 1120 ±47 W/m² or as identified in the materiel specification.
- Step 3. Maintain these conditions for 20 hours, measuring and recording the test item temperatures. If required, conduct operational checks during the last four hours of each 20-hour exposure when test temperatures are maximized.
- Step 4. Turn off the solar radiation source for four hours.
- Step 5. Repeat Steps 1 through 4 for the number of cycles identified in the test plan.
- Step 6. At the end of the last radiation cycle, allow the test item to return to standard ambient conditions.
- Step 7. Conduct a visual examination and an operational check as in paragraph 4.4.1.2, Steps 2 and 4, and document the results. Take photographs of the test item and material samples (if required) for comparison between pre- and post-test items.

5. ANALYSIS OF RESULTS.

In addition to the guidance provided in Part One, paragraphs 5.14 and 5.17, the following information is provided to assist in the evaluation of the test results. Analyze any failure of a test item to meet the requirements of the materiel specifications.

- a. Procedure I. Do not alter the performance characteristics either at the peak temperature or after return to standard ambient conditions to the extent that the test item does not meet its requirements. Record as observations only those actinic effects that do not affect performance, durability, or required characteristics.
- b. Procedure II. Do not alter the performance and characteristics (such as color or other surface conditions) of the test item to the extent that the test item does not meet requirements. Record actinic effects that do not affect performance, durability, or required characteristics as observations only. The fading of colors could result in higher heating levels within the test item.

6. REFERENCE/RELATED DOCUMENTS.

- a. AR 70-38, Research, Development, Test and Evaluation of Materiel for Extreme Climatic Conditions.
- b. MIL-HDBK-310, Global Climatic Data for Developing Military Products.
- c. Synopsis of Background Material for MIL-STD-210B, Climatic Extremes for Military Equipment. Bedford, MA: AF Cambridge Research Laboratories, January 1974. DTIC number AD-780-508.

- d. NATO STANAG 2895, Extreme Climatic Conditions and Derived Conditions for Use in Defining Design/Test Criteria for NATO Forces Materiel.
- e. NATO STANAG 4370, AECTP 300, Climatic Test Methods, Method 305, Solar Radiation.
- f. "Ultraviolet Spectral Energy Distribution of Natural Sunlight and Accelerated Test Light Sources"; R.C. Hirt, R.G. Schmitt, N.D. Searle and A.P. Sullivan; Journal of the Optical Society of America, July 1960, vol. 50, p. 706.
- g. "Studies of Spectral Energy Distribution of Different Light Sources in Connection with Solar Simulation"; D.W. Gibson and J. Weinard; Institute of Environmental Sciences 1962 Proceedings, p. 453.
- h. "Ultraviolet Radiation"; L.R. Koller; Wiley, 2nd Edition, 1965.
- i. "An Artificial Sunshine Solarium"; G.F. Prideaux, Illuminating Engineering, 1946, Vol. 12, p.762.
- j. "Project Assess - a Report of a Long Term Solar Simulation Test"; R. Kruger, Institute of Environmental Sciences 1966 Proceedings, p. 271.
- k. "Spectral Distribution of Typical Daylight as a Function of Correlated Color Temperature"; D.B. Judd, D.L. MacAdam and G. Wyszecki; Journal of the Optical Society of America, August 1964, vol. 54, p. 1031.
- l. "Simulating the Solar Spectrum with a Filtered High-pressure Xenon Lamp"; E.A. Boettner and L.J. Miedler, Applied Optics, 1963, vol. 2, p. 105.
- m. "Modular Xenon Solar Simulation of Large Area Application"; J.A. Castle, Institute of Environmental Sciences, 1967 Proceedings, p. 687.
- n. "Four-foot Solar Simulation System"; R.N. Harmon, Institute of Environmental Sciences 1966 Proceedings p. 531.
- o. "Radiation Instruments and Measurements"; International Geophysical Year Manual, Part VI, 1958, Pergamon Press.
- p. "Deterioration of Materials"; G.A. Greathouse and C.J. Wassel, Reinhold, New York, 1954.
- q. "The Simulation of Solar Radiant Energy"; P.W. Baker, Environmental Engineering Quarterly June 1963, p. 17-19 and Sept 1963, p. 14-17.
- r. "Measurement of Spectral Irradiance"; J. Arveson, Handbook of Solar Simulation for Thermal Vacuum Testing, Section 9B Institute of Environmental Sciences, 1968.
- s. "The Solar Constant and the Solar Spectrum Measured from a Research Aircraft"; M.P. Thekaekara, NASA TR R-351, Washington, DC, Oct 1970.

MIL-STD-810F
1 January 2000

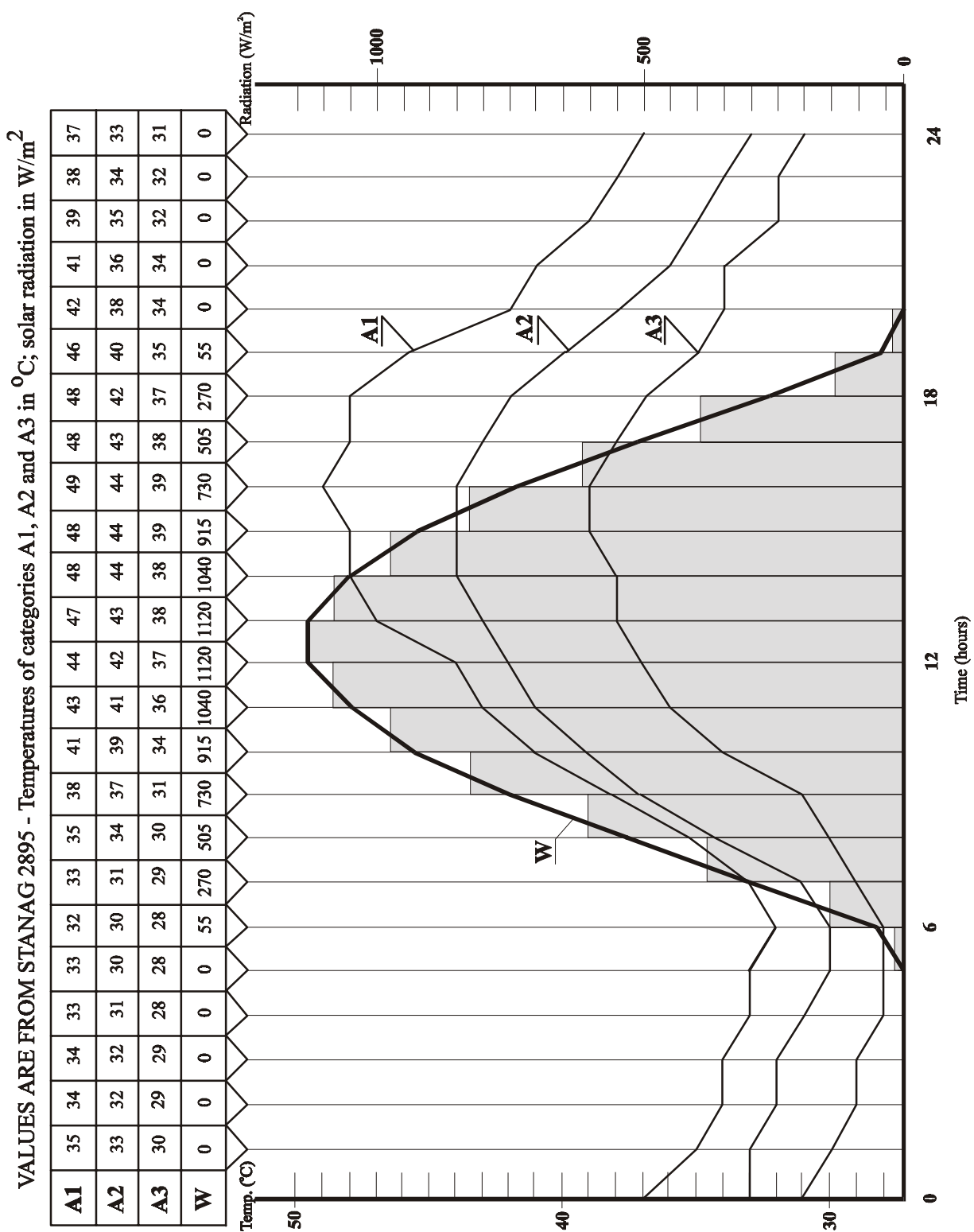

FIGURE 505.4-1. Procedure 1 - Cycling Test.

Temperatures in °C; solar radiation in W/m²

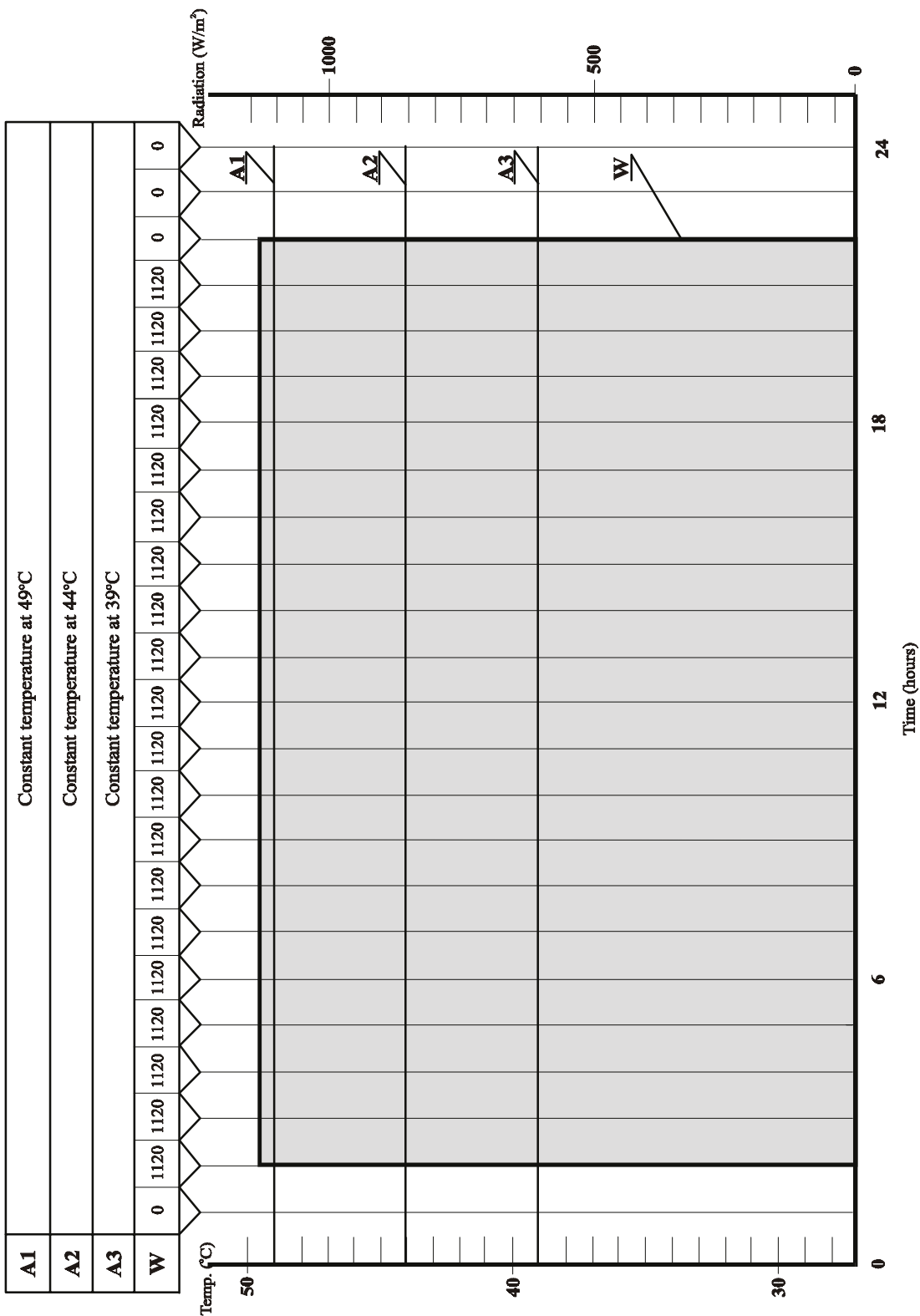

FIGURE 505.4-2. Procedure 2 - Steady State Test.

MIL-STD-810F
1 January 2000

THIS PAGE INTENTIONALLY BLANK

ANNEX A

DETAILED GUIDANCE ON SOLAR RADIATION TESTING

1. INTRODUCTION.

This Annex describes methods of simulation designed to examine the effects of solar radiation on materiel. The main quantities to be simulated are the spectral energy distribution of the sun as observed at the Earth's surface and the intensity of received energy, in combination with controlled temperature conditions. However, it may be necessary to consider a combination of solar radiation - including sky radiation - with other environments, e.g., humidity, air velocity, etc.

2. IRRADIANCE AND SPECTRAL DISTRIBUTION.

The effect of radiation on the materiel will depend mainly on the level of irradiance and its spectral distribution.

2.1 Irradiance.

The irradiance by the sun on a plane perpendicular to the incident radiation outside the Earth's atmosphere at the mean Earth-sun distance is known as the solar constant "I₀." The irradiance at the surface of the Earth is influenced by the solar constant and the attenuation and scattering of radiation in the atmosphere. For test purposes, a maximum intensity of 1120 W/m² is specified to simulate the global (total) radiation at the surface of the Earth from the sun and the sky with the sun at zenith, based on a solar constant I₀ = 1350 W/m². The true solar constant is thought to be about 1365-1370 W/m².

2.2 Spectral Distribution - Sea Level Versus High Altitude.

At high altitude, solar radiation contains a greater proportion of damaging UV radiation than at sea level. The internationally-agreed spectrum (see table 505.4A-I) recommended for general testing is a representation of the real environment at 4-5 km. This spectrum is recommended for use at both sea level and at high altitude.

3. OTHER ENVIRONMENTAL FACTORS TO BE CONSIDERED.

Attention is drawn to the possible cooling effects of air flow over materiel. This can also result in misleading errors in open-type thermopiles used to monitor radiation intensity; ventilation of pyranometers may be necessary to keep the glass dome cool. An air flow of as little as one meter per second can effect a reduction in temperature rise of over 20%. In practice, high solar radiation conditions are rarely accompanied by complete absence of wind. It may be necessary, therefore, to assess the effect of different air velocities over materiel under test. The materiel specification should state any special requirements in this respect. It is essential, therefore, to measure and control the rate of air flow in order to maintain the required air temperature at the test item.

4. RADIATION SOURCES.

4.1 General.

The radiation source may comprise one or more lamps and their associated optical components, e.g., reflectors, filters, etc., to provide the required spectral distribution and irradiance. The high pressure xenon arc lamp with filters can provide the best spectral match. Mercury vapor and xenon-mercury lamps have considerable deficiencies in matching which would lead to error. The carbon arc, with specially-doped electrodes, has been widely used but presents difficulties as regards stability and maintenance, and is therefore not generally favored. If not already covered in test method characteristics of these sources, features of filters, optical arrangements, etc., are covered in the following paragraphs. The following general information about several light sources may be helpful.

MIL-STD-810F
1 January 2000

- a. Xenon lamps. The configuration and size of the lamp(s) used will depend on the test required. The relative spectral distribution of the xenon arc radiation has been found to be substantially independent of lamp power. However, variation of lamp power will change the temperature of the electrodes and hence the spectral distribution of their radiation. With long arc lamps, it is relatively simple to mask off the electrode radiation. The form of construction of the short arc lamp leads to considerably wider manufacturing variation compared with the long arc, a point particularly important when replacement becomes necessary. Routine replacement of either type of lamp will be needed, since the emission will change continuously with life, and there may be wide variations of the life characteristic from lamp to lamp.
- b. Carbon arc. Under certain conditions, the carbon arc can be made to provide radiation of a spectral distribution somewhat similar to that of the sun as observed at ground level, but correcting filters are needed, especially in the ultraviolet region. The combustible nature of the source has the disadvantages of lack of precise location and of impermanence. Perhaps the greatest disadvantage of the carbon arc is its burning away. Even with a carefully arranged feed mechanism, the continuous burning time is unlikely to exceed 13 hours.
- c. Metal Halide (HMI). Although this lamp imparts more energy in the ultraviolet range and low visible range than specified in table 505.4-I, it provides a good source for tests requiring attention to thermal effects, since the additional UV energy represents less than one per cent of the total energy, and tests for heating effects are generally sufficiently short in duration that actinic degradation will not be a concern. For testing actinic effects, the energy level in the heating range will be lower than specified as the UV levels will be adjusted to table 505.4A-I levels. Since the energy level between 0.32 and 0.40 μ m increases sharply as the lamp power level is reduced, power cannot be used to adjust overall energy levels once the desired distribution has been obtained.

4.2 Filters.

Liquid filters have certain disadvantages such as the possibility of boiling, the temperature coefficient of spectral transmission, and long term drift in spectral character. The present preference is for glass filters to be used, although the characteristics of glass filters are not as accurately reproduced as those of a chemical solution filter. Some trial and error may be necessary to compensate for different optical densities by using different plate thicknesses. Glass filters are proprietary articles and manufacturers should be consulted concerning the choice of filters suitable for particular purposes. The choice will depend on the source and its methods of use. For example, a xenon source may be test-compensated by a combination of infrared and ultraviolet absorbing filters. Some glass infrared filters may be prone to rapid changes in spectral characteristics when exposed to excessive ultraviolet radiation. This deterioration may be largely prevented by interposing the ultraviolet filter between the source and the infrared filter. Interference type filters, which function by reflecting instead of absorbing the unwanted radiation, (thus resulting in reduced heating of the glass), are generally more stable than absorption filters.

4.3 Uniformity of Irradiance.

Owing to the distance of the sun from the Earth, solar radiation appears at the Earth's surface as an essentially parallel beam. Artificial sources are relatively close to the working surface and means of directing and focusing the beam must be provided with the aim of achieving a uniform irradiance at the measurement plane within specification limits (i.e., 1120 W/m² (+10, -0 W/m²)). This is difficult to achieve with a short-arc xenon lamp with a parabolic reflector because of shadows from the lamp electrodes and supports. Also, the incandescence of the anode can produce considerable radiation at a much lower color temperature, slightly displaced from the main beam, if only the arc itself is at the focus of the reflector. Uniform irradiation is more readily achieved with a long arc lamp mounted in a parabolic 'trough' type reflector. However, by employing very elaborate mounting techniques, it is possible to irradiate, with some degree of uniformity, a large surface by a number of short arc xenon lamps. It is generally advisable to locate radiation source(s) outside the test enclosure or chamber. This avoids possible degradation of the optical components, e.g., by high humidity conditions, and contamination of test items by ozone that has been generated by xenon and other types of arc lamps. Precise collimation of the radiation beam is not normally required except for testing special materiel such as solar cells, solar tracking devices, etc. However, some

of the simulation techniques developed for space research purposes could be adapted for Earth-surface solar radiation studies.

5. INSTRUMENTATION.

5.1 Measurement of Irradiance.

The type of instrument considered most suitable for monitoring the irradiance is a pyranometer as used for measuring global (combined solar and sky) radiation on a horizontal plane. Two types are suitable for measuring radiation from a simulated solar source. Each depends for its operation on thermojunctions.

5.1.1 Moll-Gorcziński pyranometer.

The Moll-Gorcziński pyranometer consists of 14 constantan-manganin strips (10 x 1 x 0.005 mm) arranged so that their 'hot' junctions lie on a plane and are formed into a horizontal surface by means of a black varnish of low thermal conductivity. The "cold" junction ends are bent down to make good thermal connections with a copper plate of large thermal capacity. The sensitive area is surmounted by two concentric glass hemispheres.

5.1.2 Eppley precision spectral pyranometer.

The sensor is a circular 50-junction wire wound plated (copper-constantan) thermopile, enclosed in concentric, clear-glass hemispheres, 30 mm and 50 mm diameter. The outer hemisphere is interchangeable with another, either of glass absorbing in particular wavelength bands, or with a deposited interference type filter, allowing the separation of radiation into well-defined wavelength intervals. Neither of these instruments is significantly affected by long-wave IR radiation emitted by the specimen or the test enclosure. A modification of the Moll-Gorcziński pyranometer, commonly known as the Kipp solarimeter, is the instrument used by meteorological services in many countries. The Eppley pyranometer is the one most widely used in the United States. The glass covers used in both these instruments will cut off radiation at wavelengths greater than about 3 mm; this is only significant when unfiltered tungsten lamps are used and a correction factor would then be necessary.

5.2 Measurement of Spectral Distribution.

Total intensity checks are readily made, but detailed checks on spectral characteristics are more difficult. Major spectral changes can be checked by inexpensive routine measurements, using a pyranometer in conjunction with selective filters. For checking the detail spectral distribution characteristics of the facility, it would be necessary to employ sophisticated spectroradiometric instrumentation. However, there seems to be no practical instrumentation obstacle to prevent this calibration being done either as a service by the facility manufacturer or by a visit from a national calibration center. Correlation should be achieved between the filter/pyranometer and spectroradiometric methods at regular intervals. Changes in the spectral characteristics of lamps, reflectors and filters may occur over a period of time which could result in the spectral distribution being seriously outside the permitted tolerances. Manufacturing tolerances may mean that lamp replacement could result in unacceptable changes in both the level of irradiation and spectral distribution compared with that initially set up. Regular monitoring is therefore essential, but monitoring of the detailed spectral distribution within the test facility may not be possible while an item is undergoing test. A method of measuring the intensity of radiation below 320 nm based on the exposure of polysulphone film and which would permit the monitoring of this wavelength range within the test facility is now established. (The technique is currently being considered as an ISO test method.)

5.3 Measurement of Temperature.

Because of the high level of radiation, it is essential that temperature sensors are adequately shielded from radiant heating effects. This applies both to measuring air temperatures within the test enclosure and also to monitoring test item temperatures. For air temperature measurements, it is obviously impractical to use the standard 'Stevenson' screen used for meteorological measurements of "shade temperatures" since this is too cumbersome. A suitable alternative is a thermocouple freely mounted in a radiation shield comprising a vertical cupro-nickel tube (approximately 1.5 cm diameter by 7 cm long), surmounted by a spaced metal hood, polished on the inside surface

MIL-STD-810F
1 January 2000

and painted white on the outside. When monitoring test item temperatures, sensors, e.g., thermocouples, should be located on the inside surfaces of the external case and should not be attached to the outside surfaces. Temperature-indicating paints and waxes are unsuitable for monitoring the temperature of irradiated surfaces, since their absorption characteristics will not be the same.

6. PREPARATION OF TEST FACILITY AND MATERIEL UNDER TEST.

6.1 Test Facility.

Ensure that the optical parts of the facility, lamps, reflectors, and filters, etc., are clean. The level of irradiation over the specified measurement plane must be measured immediately prior to each test. Throughout the test continually monitor any ancillary environmental conditions, e.g., ambient temperature, as well as air velocity and other parameters if specified.

6.2 Materiel under Test.

The method of mounting and the orientation of the test item relative to the direction of radiation will have marked influences on the heating effects. The test item will probably be required to be mounted either on raised supports or on a substrate of specified properties, e.g., a layer of concrete of specified thickness or a sand-bed of certain conductivity. All this and the attitude of the test item should be included in the relevant specification. Special attention must be paid to the surface conditions of the test item to see that its finish is clean or in accordance with the relevant requirements. The heating effect on the test item will be largely affected by the condition of its external surfaces. Care must therefore be exercised in handling the test item, especially in avoiding oil films and in ensuring that the surface finish and its underlay are fully representative of production standards. Temperature sensors should be attached to the test item as required (but see also paragraph 5.3 of this Annex).

7. INTERPRETATION OF RESULTS.

The materiel specification should indicate the permitted changes in the external conditions and/or performance of the test item after exposure to the required level of irradiation for certain durations. In addition, the following aspects of interpretation may be considered:

7.1 Comparison with Field Experience.

The effects of exposing material to solar radiation are well documented (see also paragraphs 7.2 and 7.3 below). Any marked differences between the expected effects and the behavior under test conditions should be investigated and the basic cause established, i.e., whether caused by the test equipment or procedure, or by some peculiarity in the test item.

7.2 Thermal Effects.

- a. The maximum surface and internal temperatures attained by materiel will depend on:
 - (1) the temperature of the ambient air.
 - (2) the intensity of radiation.
 - (3) the air velocity.
 - (4) the duration of exposure.
 - (5) the thermal properties of the materiel itself, e.g., surface reflectance, size and shape, thermal conductance, and specific heat.
- b. Materiel can attain temperatures in excess of 60°C if fully exposed to solar radiation in an ambient temperature as low as 35 to 40°C. The surface reflectance of an object affects its temperature rise from solar heating to a major extent; changing the finish from a dark color, for example, to a gloss white will effect a considerable reduction in temperature. Conversely, a pristine finish designed to reduce temperature can be expected to deteriorate in time resulting in an increase in temperature. Most materials are selective reflectors, i.e., their spectral reflectance changes with wavelength. For instance, paints, in general, are poor

infrared reflectors although they may be very efficient in the visible region. Furthermore, the spectral reflectance of many materials changes sharply in the visible (producing a color sensation to the human eye) and in the near infrared. It is important, therefore, that the spectral energy distribution of the radiation source(s) used in any simulated test should closely duplicate that of natural radiation.

7.3 Degradation of Materials.

The combined effects of solar radiation, atmospheric gases, temperature, humidity changes, etc., are often collectively termed “weathering,” and result in the “ageing” and ultimate destruction of most organic materials (e.g., plastics, rubbers, paints, timber, etc.). Many materials that give satisfactory service in temperate regions have been found to be completely unsuitable for use under the more adverse conditions of the tropics. Typical effects are the rapid deterioration and breakdown of paints, the cracking and disintegration of cable sheathing, and the fading of pigments. The breakdown of a material under weathering usually results not from a single reaction, but from several individual reactions of different types occurring simultaneously, often with interacting effects. Although solar radiation, principally the ultraviolet portion, resulting in photodegradation is often the major factor, its effects can seldom be separated, in practice, from those of other weathering factors. An example is the effect of ultraviolet radiation on polyvinyl chloride, where the apparent effects of ultraviolet radiation alone are small, but its susceptibility to thermal breakdown, in which oxygen probably plays a major role, is markedly increased. Unfortunately, artificial tests occasionally produce abnormal defects that do not occur under weathering. This can be often attributed to one or more of the following causes:

- a. Many laboratory sources of ultraviolet radiation differ considerably from natural solar radiation in spectral energy distribution.
- b. When the intensity of ultraviolet, temperature, humidity, etc. are increased to obtain accelerated effects, the rate of the individual reactions (which occur under normal exposure conditions), are not necessarily increased to the same extent. In some cases, e.g., fluorescent lamps, the infrared energy of the source is significantly less than that of true solar loading, resulting in a surface test temperature that is lower than would be experienced out-of-doors.
- c. The artificial tests, in general, do not simulate all the natural weathering factors.

8. HAZARDS AND PERSONNEL SAFETY.

8.1 General.

The complex equipment employed for solar radiation testing purposes will necessarily call for operation and maintenance by a skilled test staff, not only to ensure the prescribed performance of the test, but also because of the various health and safety hazards that have to be considered.

8.2 Ultraviolet Radiation.

The most obvious dangers that have to be guarded against are those associated with the harmful effects of high intensity radiation in the near ultraviolet region. In natural sunlight, the eyes are protected in two ways: the brightness of the sun makes it almost impossible to look directly at it and the ultraviolet radiation is considerably attenuated by the atmosphere. These protections may not apply to artificial sources. The eyes must be protected by filtered goggles or viewing apertures, particularly when setting up the equipment. Due to the point sources and high UV component of these sources, sunglasses may increase the danger. All testing personnel should be warned that severe eye damage can result from only short exposure to unfiltered radiation from arc-type lamps. Serious erythema (sunburn) of exposed skin will also occur. Koller (see references) states the ultraviolet radiation of sunlight is a major causal factor in cancer of the skin in the white population of the USA. The use of suitable protective clothing including protection of the head and hands is highly recommended, even when working in test enclosures irradiated by filtered sources.

MIL-STD-810F
1 January 2000

8.3 Ozone and Harmful Fumes.

Another serious health hazard arising from the use of xenon and other arc lamps is the possible buildup of local toxic concentrations of ozone during the testing period. However, the maximum production of ozone occurs at the initial switching on of the lamp, and thereafter the hot envelope of the lamp tends to degrade the ozone back to oxygen. Where forced-air cooling is employed, this cooling air should be sucked out and removed from the building and not blown into the lamp housing. In this way, the ozone hazard can be largely eliminated. Suitable detecting and measuring equipment is commercially available. The combined effects of heat and ultraviolet radiation on certain plastics (e.g., melamine laminates) may also produce toxic fumes. Particular care should therefore be taken in the choice of materials used in the construction of a test facility.

8.4 Risk of Lamp Explosions.

The use of high pressure xenon discharge lamps as the primary radiation source can also result in serious accidents unless a well planned code of practice for the handling of these arc discharge tubes has been specified and is adhered to. All such lamps (whether hot or cold, used or new) have a liability to explode violently by reason of the considerable internal pressure (two to three atmospheres when cold, but up to twenty atmospheres when hot). There should be no visible dirt or oil on the envelope, so regular cleaning with detergent and alcohol is necessary using cotton gloves and face protection during such cleaning. When cold lamps are to be stored, the effects of explosion may be limited by two layers of 0.25 mm thick polycarbonate sheet. Particular care must be taken to limit the spread of chain reaction breakdowns in multi-lamp equipment. It is possible to use armor plate glass for the dual purpose of protection against lamp explosions and as a corrective filter. Individual lamp records should be kept as a matter of routine so as to be able to detect abnormal voltage/current behavior.

8.5 Electric Shock.

Normal electric shock preventive measures must, of course, be adopted, particularly in the case of the high voltage igniter systems used with arc lamps. In some xenon lamps, the arc ignition pulse exceeds 60 kV, and an interlock system is therefore essential.

TABLE 505.4A-I. Detailed spectral distribution of global radiation.

| SPECTRAL REGION | BANDWIDTH (μm) | IRRADIANCE (W/m²) | IRRADIANCE (%) |
|------------------------|-----------------------|-------------------------------------|-----------------------|
| Ultraviolet* | 0.28 - 0.36 | 32 | 2.9 |
| | 0.36 - 0.40 | 36 | 3.2 |
| Visible** | 0.40 - 0.44 | 56 | 5.0 |
| | 0.44 - 0.48 | 73 | 6.5 |
| | 0.48 - 0.52 | 71 | 6.3 |
| | 0.52 - 0.56 | 65 | 5.8 |
| | 0.56 - 0.64 | 121 | 10.8 |
| | 0.64 - 0.68 | 55 | 4.9 |
| | 0.68 - 0.72 | 52 | 4.6 |
| Infrared | 0.72 - 0.78 | 67 | 6.0 |
| | .78 - 1.0 | 176 | 15.7 |
| | 1.0 - 1.2 | 108 | 9.7 |
| | 1.2 - 1.4 | 65 | 5.8 |
| | 1.4 - 1.6 | 44 | 3.9 |
| | 1.6 - 1.8 | 29 | 2.6 |
| | 1.8 - 2.0 | 20 | 1.8 |
| | 2.0 - 2.5 | 35 | 3.1 |
| 2.5 - 3.0 | 15 | 1.4 | |
| Totals | | 1120 | 100.0 |

*Note: The amount of radiation wavelength shorter than 0.30μm reaching the Earth's surface is small but the effect on the degradation of material can be significant. Short wavelength energy below 300 nm can cause materials to fail unnecessarily (if not present in the natural exposure). In reverse, if energy below 300 nm is present in the natural environment and not present in the accelerated exposure, material that should fail may pass the test. This is entirely material dependent because it relates to the end use in natural exposure.

** This bandwidth may apply to either the visible or IR spectrum.

MIL-STD-810F
1 January 2000

THIS PAGE INTENTIONALLY BLANK

METHOD 506.4

RAIN

NOTE: Tailoring is essential. Select methods, procedures and parameter levels based on the tailoring process described in Part One, paragraph 4.2.2, and Appendix C. Apply the general guidelines for laboratory test methods described in Part One, paragraph 5 of this standard.

1. SCOPE.

1.1 Purpose.

The purpose of this method is to help determine the following with respect to rain, water spray, or dripping water:

- a. The effectiveness of protective covers, cases, and seals in preventing the penetration of water into the materiel.
- b. The capability of the materiel to satisfy its performance requirements during and after exposure to water.
- c. Any physical deterioration of the materiel caused by the rain.
- d. The effectiveness of any water removal system.
- e. The effectiveness of protection offered to a packaged materiel.

1.2 Application.

Use this method to evaluate materiel likely to be exposed to rain, water spray, or dripping water during storage, transit, or operation. If the materiel configuration is the same, the immersion (leakage) test (method 512.4) is normally considered to be a more severe test for determining if water will penetrate materiel. There is generally no need to subject materiel to a rain test if it has previously passed the immersion test and the configuration does not change. However, there are documented situations in which rain tests revealed problems not observed during immersion tests due to differential pressure. Additionally, the immersion test may be more appropriate if the materiel is likely to be placed on surfaces with significant amounts of standing water. In most cases, both tests should be performed if appropriately identified in the life cycle profile.

1.3 Limitations.

Where a requirement exists for determining the effects of rain erosion on radomes, nose cones, fuzes, etc., consider using a rocket sled test facility or other such facility. Since any test procedure involved would be contingent on requirements peculiar to the materiel and the facility employed, a standardized test procedure for rain erosion is not included in this method. Because of the finite size of the test facilities, it may be difficult to determine atmospheric rain effects such as on electromagnetic radiation and propagation. This method is not intended for use in evaluating the adequacy of aircraft windshield rain removal provisions, nor does it address pressure washers or decontamination devices. Additionally, this method may not be adequate for determining the effects of extended periods of exposure to rain.

2. TAILORING GUIDANCE.

2.1 Selecting the Rain Method.

After examining the requirements documents and applying the tailoring process in Part One of this standard to determine where rain is foreseen in the life cycle of the materiel, use the following to aid in selecting this method and placing it in sequence with other methods. The term "rain" encompasses the full range of "free water" (blowing, steady state, drip) tests included in this method.

MIL-STD-810F
1 January 2000

2.1.1 Effects of rain environments.

Rain (when falling, upon impact, and as deposited as pooled water) has a variety of effects on materiel. Consider the following typical problems to help determine if this method is appropriate for the materiel being tested. This list is not intended to be all-inclusive and some of the examples may overlap the categories.

2.1.1.1 In the atmosphere.

In the atmosphere the effects resulting from exposure to these environments include:

- a. Interference with or degradation of radio communication.
- b. Limited radar effectiveness.
- c. Limited aircraft operations due to restricted visibility and decreased lift from wing surfaces (excessive rain rates only).
- d. Damage to aircraft in flight.
- e. Affect on artillery and missile launching.
- f. Degradation or negation of optical surveillance.
- g. Decreased effectiveness of personnel in exposed activities.
- h. Premature functioning of some fuses.
- i. Inhibited visibility through optical devices.

2.1.1.2 On impact.

On impact it erodes surfaces.

2.1.1.3 After deposition and/or penetration.

After deposition and/or penetration, the effects resulting from exposure to these environments include:

- a. Degraded strength/swelling of some materials.
- b. Increased corrosion potential, erosion, or even fungal growth.
- c. Increased weight.
- d. Electrical or electronic apparatus become inoperative or unsafe.
- e. Malfunction of electrical materiel.
- f. Freezing inside materiel that may cause delayed deterioration and malfunction by swelling or cracking of parts.
- g. Modified thermal exchange.
- h. Slower burning of propellants.

2.1.2 Sequence among other methods.

- a. General. See Part One, paragraph 5.5.
- b. Unique to this method. This method is applicable at any stage in the test program, but its effectiveness in determining the integrity of an enclosure is maximized if it is performed after the dynamic tests.

2.2 Selecting Procedures.

This method includes three rain-related test procedures: Procedure I (Rain and Blowing Rain), Procedure II (Watertightness), and Procedure III (Drip). Before conducting the test, determine which test procedure(s) and test conditions are appropriate.

2.2.1 Procedure selection considerations.

Differences among rain test procedures are explained below. Select the procedure that represents the most severe exposure anticipated for the materiel commensurate with materiel size. When selecting a procedure, consider:

- a. The materiel configuration.
- b. The logistical and operational requirements (purpose) of the materiel.
- c. The operational purpose of the materiel and data to verify it has been met.
- d. The natural exposure circumstances.
- e. Procedure sequence.

2.2.2 Difference among procedures.

- a. Procedure I - Rain and Blowing Rain. Procedure I is applicable for materiel which will be deployed out-of-doors and which will be unprotected from rain or blowing rain. The accompanying wind velocity can vary from almost calm to extremely high. Consider using either Procedure II or Procedure III for materiel that cannot be adequately tested with this procedure because of its (large) size.
- b. Procedure II - Watertightness. Consider Procedure II when large (shelter-size) materiel is to be tested and a blowing-rain facility is not available or practical. This procedure is not intended to simulate natural rainfall but will provide a high degree of confidence in the watertightness of materiel.
- c. Procedure III - Drip. Procedure III is appropriate when materiel is normally protected from rain but may be exposed to falling water from condensation or leakage from upper surfaces.

2.3 Determine Test Levels and Conditions.

Having selected this method and relevant procedures (based on the materiel's requirements documents and the tailoring process), it is necessary to complete the tailoring process by selecting specific parameter levels and special test conditions/techniques for these procedures based on requirements documents, Life Cycle Environmental Profile, Operational Environment Documentation (see Part One, Figure 1-1), and information provided with this procedure. From these sources of information, determine the functions to be performed by the materiel in rain environments or following storage in rain environments. Then determine the rainfall levels of the geographical areas and micro-environments in which the materiel is designed to be employed. Variables under each test procedure include the test item configuration, rainfall rate, wind velocity, test item exposure surfaces, water pressure, and any additional appropriate guidelines in accordance with the requirements document.

2.3.1 Test item configuration.

Perform the test using all the configurations in which the materiel may be placed during its life cycle. As a minimum, consider the following configurations:

- a. In a shipping/storage container or transit case.
- b. Protected or not protected.
- c. In its operational configuration.
- d. Modified with kits for special applications.

NOTE: Do not use any sealing, taping, caulking, etc., except as required by the design specification for the materiel. Unless otherwise specified, do not use test items that have surface contamination such as oil, grease, or dirt, which could prevent wetting.

2.3.2 Rainfall rate.

The rainfall rate used in Procedure I may be tailored to the anticipated deployment locale and duration. Although various rainfall intensities have been measured in areas of heavy rainfall, recommend a minimum rate of 1.7 mm/min (4 in/hr) since it is not an uncommon occurrence and would provide a reasonable degree of confidence in the materiel. MIL-HDBK-310 contains further information.

MIL-STD-810F
1 January 2000

2.3.3 Droplet size.

Nominal drop-size spectra exist for instantaneous rainfall rates but for the long-term rainfall rates they are meaningless since rates are made up of many different instantaneous rates possessing different spectra (reference b). For Procedures I and II, use droplet sizes predominantly in the range of approximately 0.5 mm in diameter^{1/} (which is considered to be mist or drizzle rather than rain (reference e), to 4.5 mm in diameter (reference i). For drip tests using dispensing tubes (figure 506.4-1), polyethylene tubing sleeves added to the dispensing tubes will increase the droplet size to its maximum.

NOTE: Observations have shown that water droplets introduced into a high velocity air stream tend to break up over distance (references j and k). Accordingly, recommend introducing the droplets as close as possible to the test item while assuring the droplets achieve the required velocity prior to impact with the test item.

2.3.4 Wind velocity.

High rainfall intensities accompanied by winds of 18 m/s (40 mph) are not uncommon during storms. Unless otherwise specified or when steady state conditions are specified, recommend this velocity. Where facility limitations preclude the use of wind, use Procedure II or III.

2.3.5 Test item exposure surface (orientation).

Wind-blown rain will usually have more of an effect on vertical surfaces than on horizontal surfaces, and vice versa for vertical or near-vertical rain. Expose all surfaces onto which the rain could fall or be driven to the test conditions. Rotate the item as required to expose all vulnerable surfaces.

2.3.6 Water pressure.

Procedure II relies on pressurized water. Vary the pressure as necessary to comply with the requirement's documents, but a minimum value of 276 kPa (40 psig) nozzle pressure is given as a guideline based on past experience. This value will produce water droplets traveling at approximately 64 km/h (40 mph) when a nozzle as specified in paragraph 4.1.2 is used.

2.3.7 Preheat temperature.

Experience has shown that a temperature differential between the test item and the rainwater can affect the results of a rain test. When specified for nominally sealed items, increasing the test item temperature to about 10°C higher than the rain temperature at the beginning of each exposure period to subsequently produce a negative pressure inside the test item will provide a more reliable verification of its watertightness. Ensure the heating time is the minimum required to stabilize the test item temperature, and not sufficient to dry the test item when not opened between exposures.

2.3.8 Exposure duration.

Determine the exposure duration from the life cycle profile, but do not use a duration less than that specified in the individual procedures. For items made of material that may absorb moisture, the duration may have to be significantly extended to reflect real life cycle circumstances and, for drip tests, the drip rate appropriately reduced.

3. INFORMATION REQUIRED.

3.1 Pretest.

The following information is required to conduct rain tests adequately.

- a. General. Information listed in Part One, paragraphs 5.7 and 5.9, and Appendix A, Task 405 of this standard.

^{1/}Observations show there are no drops of less than roughly 0.5 mm diameter during intense rains (reference c).

- b. Specific to this method.
 - (1) Rainfall rate.
 - (2) Exposure surfaces/duration.
 - (3) Test item preheat temperature.
 - (4) Initial water temperature.
 - (5) Wind velocity.
 - (6) Water pressure (if appropriate).

3.2 During Test.

For test validation purposes, record deviations from planned or pre-test procedures or parameter levels, including any procedural anomalies that may occur.

3.3 Post-test.

Record the following post-test information.

- a. General. Information listed in Part One, paragraph. 5.13, and in Appendix A, Task 406 of this standard.
- b. Specific to this method.
 - (1) Surfaces of the test item subjected to rainfall.
 - (2) Duration of exposure per face.
 - (3) Results of inspection for water penetration (amount and probable point of entry).
 - (4) Results of operational checks.
 - (5) Length of time for each performance check.

4. TEST PROCESS.

4.1 Test Facility.

4.1.1 Procedure I.

- a. Use a rain facility capable of producing falling rain at the rate specified herein. To produce the rain, use a water distribution device that produces droplets having a diameter range predominantly between 0.5 mm and 4.5 mm. Ensure the rain is dispersed completely over the test item when accompanied by the prescribed wind. A water-soluble dye such as fluorescein may be added to the rainwater to aid in locating and analyzing water leaks. For steady state rain, use either spray nozzles or the apparatus shown on figure 506.4-1, and position the dispenser at a height sufficient to ensure the drops approach terminal velocity. It is not necessary to use de-ionized or distilled water for this test.
- b. Position the wind source with respect to the test item so that it will cause the rain to beat directly, with variations up to 45° from the horizontal, and uniformly against one side of the test item. Use a wind source that can produce horizontal wind velocities equal to and exceeding 18 m/s. Measure the wind velocity at the position of the test item before placement of the test item in the facility. Do not allow rust or corrosive contaminants on the test item.

4.1.2 Procedure II.

Use nozzles that produce a square spray pattern or other overlapping pattern (for maximum surface coverage) and with a droplet size predominantly in the 0.5 to 4.5 mm range at approximately 276 kPa. Use at least one nozzle for each 0.56m² (6 ft²) of surface area and position each about 48 cm from the test surface. Adjust this distance as necessary to achieve overlap of the spray patterns. A water-soluble dye such as fluorescein added to the rainwater may aid in locating and analyzing any water leaks. For Procedure II, position the nozzles as required by the test plan or as depicted on figure 506.4-2.

MIL-STD-810F
1 January 2000

4.1.3 Procedure III.

Use a test setup that provides a volume of water greater than 280 l/m²/hr (7 gal/ft²/hr) dripping from a dispenser with drip holes on a 20 to 25.4 mm pattern (depending on which dispenser is used) but without coalescence of the drips into a stream. Figures 506.4-1 and 506.4-3 provide possible dispenser designs. Either arrangement shown on figure 506.4-1 is recommended over that of figure 506.4-3 due to its simplicity of construction, maintenance, cost, and reproducibility of tests. The polyethylene tubing is optional, but it ensures maximum droplet size. Use a drip height that ensures terminal velocity of the droplets (~9 m/s). Use a dispenser with a drip area large enough to cover the entire top surface of the test item. A water-soluble dye such as fluorescein added to the rainwater may aid in locating and analyzing water leaks.

4.2 Controls.

- a. For Procedures I and II, verify the rainfall rate immediately before each test.
- b. For Procedure I, verify the wind velocity immediately before each test.
- c. For Procedures I and II, verify the nozzle spray pattern and pressure before each test.
- d. For Procedure III, verify the flow rate immediately before the test and ensure that only separate (or discrete) drops are issuing from the dispenser.
- e. Unless otherwise specified, water used for rain tests can be from local water supply sources.

4.3 Test Interruption.

- a. General. See Part One, paragraph 5.11 of this standard.
- b. Specific to this method. Interruption of a rain test is unlikely to generate any adverse effects. Normally, continue the test from the point of interruption.

4.4 Execution.

The following steps, alone or in combination, provide the basis for collecting necessary information concerning the materiel's watertightness.

4.4.1 Preparation for test.

4.4.1.1 Preliminary steps.

Before starting the test, review pretest information in the test plan to determine test details (e.g., procedures, test item configuration/orientation, cycles, durations, parameter levels for storage/operation, rainfall rates and wind velocities (for Procedures I), etc.). (See paragraph 3.1, above.)

4.4.1.2 Pretest standard ambient checkout.

All test items require a pretest standard ambient checkout to provide baseline data. Conduct the checkout as follows:

- Step 1. Stabilize the test item at standard ambient conditions (Part One, paragraph 5.1), in the test chamber, whenever possible.
- Step 2. Conduct a complete pretest examination and document the results.
- Step 3. Prepare the test item in accordance with Part One, paragraph 5.8 and in the required test item configuration.
- Step 4. To establish baseline data, conduct an operational checkout in accordance with the test plan, and record the results.

4.4.2 Procedure I - Rain and blowing rain.

- Step 1. With the test item in the facility and in its normal operating position, adjust the rainfall rate as specified in the test plan. If the temperature differential between the water and the test item is less than 10°C, either heat the test item to a higher temperature than the rain water (see paragraph

2.3.7) such that the test item temperature has been stabilized at $10 \pm 2^\circ\text{C}$ above the rain water temperature at the start of each exposure period (see paragraph 2.3.7), or cool the water. Restore the test item to its normal operating configuration immediately before testing.

- Step 2. Initiate the wind at the velocity specified in the test plan and maintain it for at least 30 minutes.
- Step 3. If required, operate the test for the last 10 minutes of the 30-minute rain.
- Step 4. Rotate the test item to expose it to the rain and blowing wind source to any other side of the test item that could be exposed to blowing rain in its deployment cycle.
- Step 5. Repeat Steps 1 through 4 until all surfaces have been tested.
- Step 6. Examine the test item in the test chamber (if possible), otherwise, remove the test item from the test facility and conduct a visual inspection. If water has penetrated the test item, judgment must be used before operation of the test item. It may be necessary to empty water from the test item (and measure the quantity) to prevent a safety hazard.
- Step 7. Measure and document any free water found inside the protected areas of the test item.
- Step 8. If required, operate the test item for compliance with the requirements document, and document the results.

4.4.3 Procedure II - Watertightness.

- Step 1. Install the test item in the test facility with all doors, louvers, etc., closed.
- Step 2. Position the nozzles as required by the test plan or as indicated on figure 506.4-2.
- Step 3. Spray all exposed surfaces of the test item with water for not less than 40 minutes per face.
- Step 4. After each 40-minute spray period, inspect the interior of the test item for evidence of free water. Estimate its volume and the probable point of entry and document.
- Step 5. Conduct an operational check of the test item as specified in the test plan, and document the results.

4.4.4 Procedure III - Drip.

- Step 1. Install the test item in the facility in accordance with Part One, paragraph 5.8 and in its operational configuration with all connectors and fittings engaged. Ensure the temperature differential between the test item and the water is 10°C or greater. If necessary, either raise the test item temperature or lower the water temperature to achieve the differential in paragraph 2.3.7, and restore the test item to its normal operating configuration immediately before testing.
- Step 2. With the test item operating, subject it to water falling from a specified height (no less than 1 meter (3 feet)) as measured from the upper main surface of the test item at a uniform rate for 15 minutes or as otherwise specified (see figure 506.4-1 or figure 506.4-3). Use a test setup that ensures that all of the upper surfaces get droplets on them at some time during the test. For test items with glass-covered instruments, tilt them at a 45° angle, dial up.
- Step 3. At the conclusion of the 15-minute exposure, remove the test item from the test facility and remove sufficient panels or covers to allow the interior to be seen.
- Step 4. Visually inspect the test item for evidence of water penetration.
- Step 5. Measure and document any free water inside the test item.
- Step 6. Conduct an operational check of the test item as specified in the test plan, and document the results.

5. ANALYSIS OF RESULTS.

In addition to the guidance provided in Part One, paragraphs 5.14 and 5.17, the following information is provided to assist in the evaluation of the test results. Analyze any failure of a test item to meet the requirements of the materiel specifications and consider related information such as follows.

5.1 Operational Failures.

- a. Degradation allowed in the performance characteristics because of rainfall exposure.
- b. Necessity for special kits for special operating procedures.
- c. Safety of operation.

MIL-STD-810F
1 January 2000

5.2 Water Penetration.

Based on the individual materiel and the requirements for its non-exposure to water, determine if one of the following is applicable:

- a. Unconditional failure. Any evidence of water penetration into the test item enclosure following the rain test.
- b. Acceptable water penetration. Water penetration of not more than 4 cm³ per 28,000 cm³ (1 ft³) of test item enclosure provided the following conditions are met:
 - (1) There is no immediate effect of the water on the operation of the materiel.
 - (2) The test item in its operational configuration (transit/storage case open or removed) can successfully complete the aggravated temperature/humidity procedure of method 507.4.

6. REFERENCE/RELATED DOCUMENTS.

- a. AR 70-38, Research, Development, Test and Evaluation of Materiel for Extreme Climatic Conditions.
- b. MIL-HDBK-310, Global Climatic Data for Developing Military Products.
- c. Synopsis of Background Material for MIL-STD-210B, Climatic Extremes for Military Equipment. Bedford, MA: Air Force Cambridge Research Laboratories, 1974, DTIC number AD-780-508.
- d. Army Materiel Command Pamphlet AMCP-706-116, Engineering Design Handbook, Environmental Factors.
- e. Huschke, R. E. (ed.), Glossary of Meteorology. Boston: American Meteorological Society, 1970.
- f. RTCA/DO-160D, Environmental Conditions and Test Procedures for Airborne Equipment.
- g. Tattelman, P.I., and Sissenwine, N., Extremes of Hydrometers at Altitude for MIL-STD-210B: Supplement Drop Size Distributions (1973), AFCRL-TR-73-0008, AFSG 253.
- h. R.M. Clayton et al, Rain Simulation for High-Intensity Acoustic Noise Cavities. Jet Propulsion Laboratory, California Institute of Technology, Pasadena, CA, Report NPO-17237/6745.
- i. Rogers, R.R., Short Course in Cloud Physics, Pergamon Press, Oxford; 1979.
- j. STANAG 4370, Environmental Testing.
- k. Allied Environmental Conditions and Test Publication 300, Climatic Environmental Testing (under STANAG 4370).

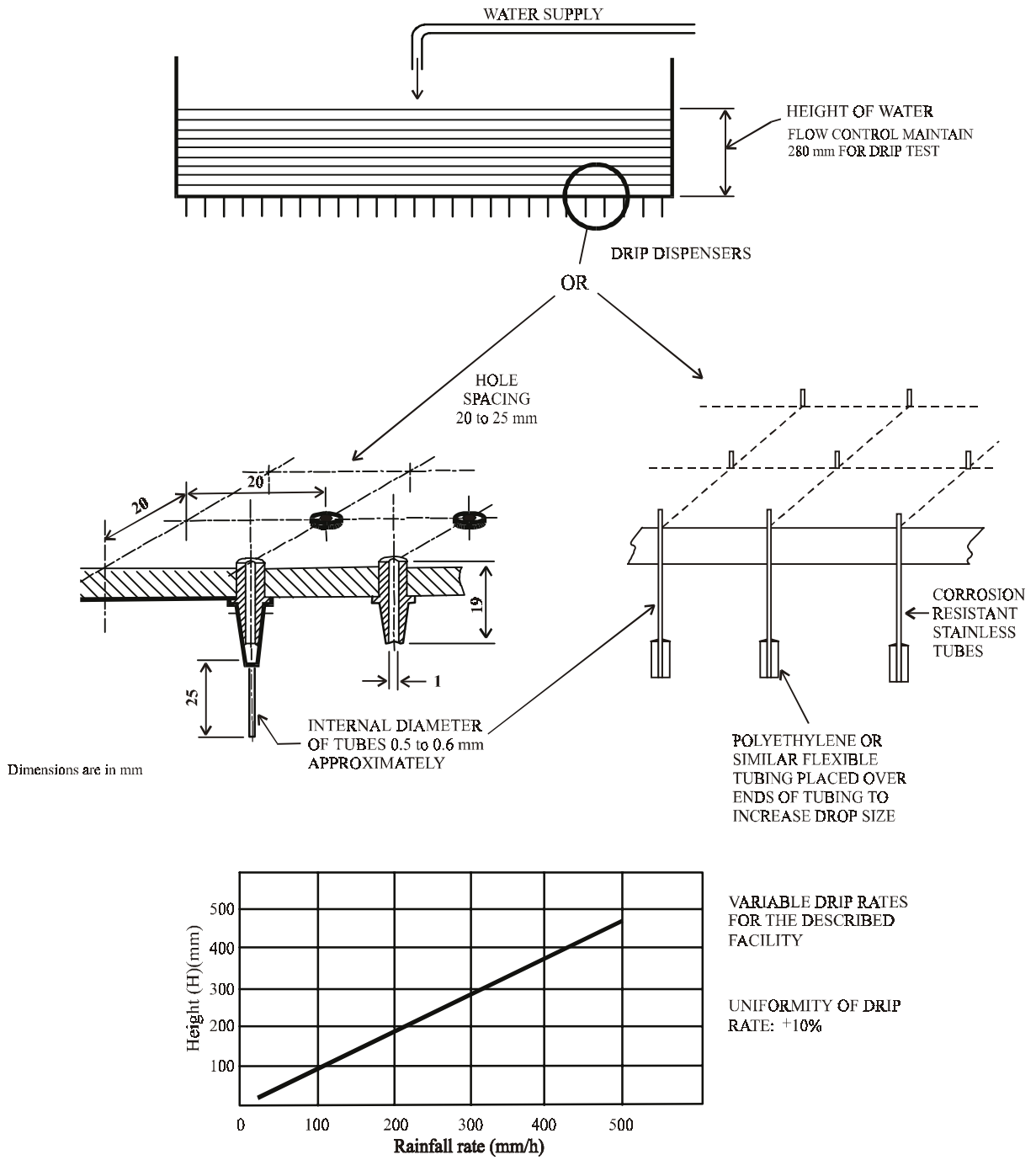
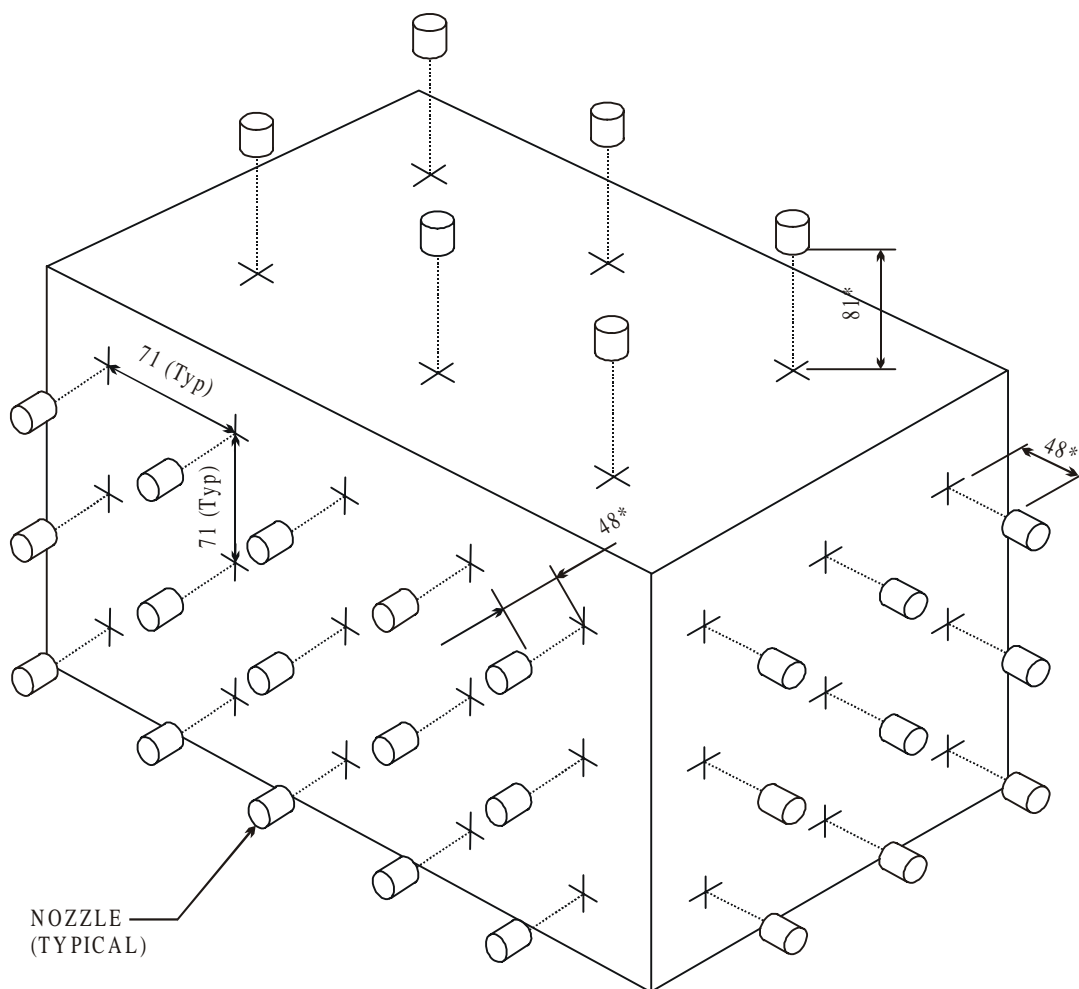

FIGURE 506.4-1. Sample facility for steady state rain or drip test.

MIL-STD-810F
1 January 2000



* Adjust as necessary to get spray overlap

NOTE: Dimensions are in cm. Ensure nozzles are perpendicular to the surface(s) and situated such that each surface (especially vulnerable areas) is sprayed.

FIGURE 506.4-2. Typical nozzle setup for watertightness test, Procedure II.

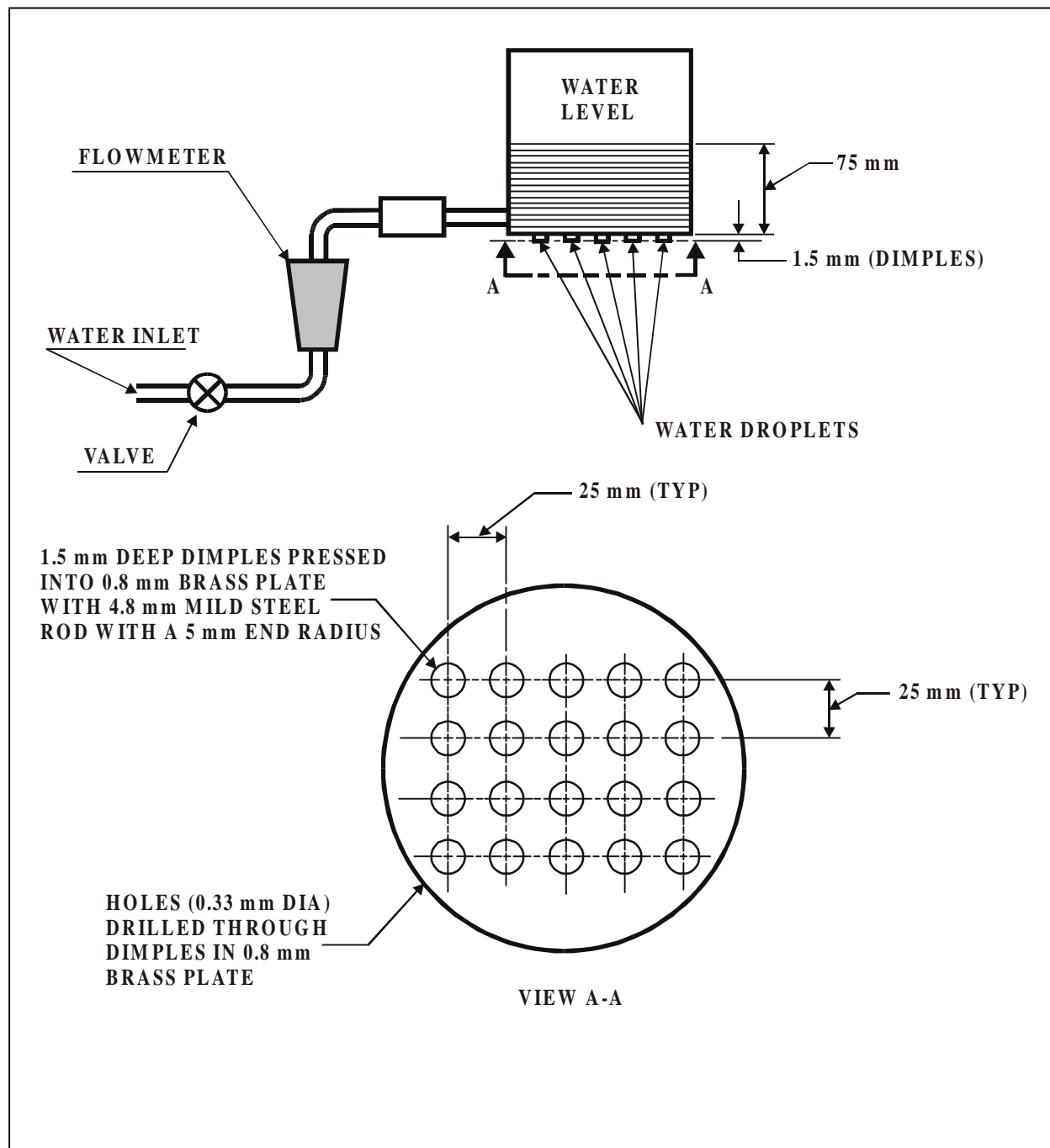

FIGURE 506.4-3. Details of dispenser for drip test, Procedure III.

MIL-STD-810F
1 January 2000

THIS PAGE INTENTIONALLY BLANK

METHOD 507.4

HUMIDITY

NOTE: Tailoring is essential. Select methods, procedures, and parameter levels based on the tailoring process described in Part One, paragraph 4.2.2, and Appendix C. Apply the general guidelines for laboratory test methods described in Part One, paragraph 5 of this standard.

1. SCOPE.

1.1 Purpose.

The purpose of this method is to determine the resistance of materiel to the effects of a warm, humid atmosphere.

1.2 Application.

This method applies to materiel that is likely to be stored or deployed in a warm, humid environment or an environment in which high levels of humidity occur. Although it is preferable to test materiel at appropriate natural environment sites, it is not always practical because of logistical, cost, or schedule considerations. Warm, humid conditions can occur year-round in tropical areas, seasonally in mid-latitude areas, and in materiel subjected to combinations of changes in pressure, temperature, and relative humidity. Other high levels of humidity can exist worldwide.

1.3 Limitations.

This method may not reproduce all of the humidity effects associated with the natural environment such as long-term effects, nor with low humidity situations. This method does not attempt to duplicate the complex temperature/humidity environment but, rather, it provides a generally stressful situation that is intended to reveal potential problem areas in the materiel. Therefore, this method does not contain natural or induced temperature/humidity cycles as in previous editions. Specifically, this method does not address:

- a. Condensation resulting from changes of pressure and temperature for airborne or ground materiel.
- b. Condensation resulting from black-body radiation (e.g., night sky effects).
- c. Synergistic effects of humidity or condensation combined with biological and chemical contaminants.
- d. Liquid water trapped within materiel or packages and retained for significant periods.
- e. This method is not intended for evaluating the internal elements of a hermetically sealed assembly since such materiel is air-tight.

2. TAILORING GUIDANCE.

2.1 Selecting the Humidity Method.

After examining requirements documents and applying the tailoring process in Part One of this standard to determine if warm temperature/humidity conditions are anticipated in the life cycle of materiel, use the following to confirm the need for this method and to place it in sequence with other methods.

2.1.1 Effects of warm, humid environments.

Humidity has physical and chemical effects on materiel; the temperature and humidity variations can also trigger condensation inside materiel. Consider the following typical problems to help determine if this method is appropriate for the materiel being tested. This list is not intended to be all-inclusive.

- a. Surface effects, such as:

MIL-STD-810F
1 January 2000

- (1) Oxidation and/or galvanic corrosion of metals.
 - (2) Increased chemical reactions.
 - (3) Chemical or electrochemical breakdown of organic and inorganic surface coatings.
 - (4) Interaction of surface moisture with deposits from external sources to produce a corrosive film.
 - (5) Changes in friction coefficients, resulting in binding or sticking.
- b. Changes in material properties, such as:
- (1) Swelling of materials due to sorption effects.
 - (2) Other changes in properties.
 - (a) Loss of physical strength.
 - (b) Electrical and thermal insulating characteristics.
 - (c) Delamination of composite materials.
 - (d) Change in elasticity or plasticity.
 - (e) Degradation of hygroscopic materials.
 - (f) Degradation of explosives and propellants by absorption.
 - (g) Degradation of optical element image transmission quality.
 - (h) Degradation of lubricants.
- c. Condensation and free water, such as:
- (1) Electrical short circuits.
 - (2) Fogging of optical surfaces.
 - (3) Changes in thermal transfer characteristics.

2.1.2 Sequence among other methods.

- a. General. See Part One, paragraph 5.5.
- b. Unique to this method. Humidity testing may produce irreversible effects. If these effects could unrealistically influence the results of subsequent tests on the same item(s), perform humidity testing following those tests. Also, because of the potentially unrepresentative combination of environmental effects, it is generally inappropriate to conduct this test on the same test sample that has previously been subjected to salt fog, sand and dust, or fungus tests.

2.2 Selecting Procedure Variations.

This method has one procedure. Possible variations are described below.

2.2.1 Test duration.

The minimum number of 48-hour cycles for this test is five. This has historically proven adequate to reveal potential effects in most materiel. Extend the test as specified in the test plan to provide a higher degree of confidence in the materiel to withstand warm, humid conditions.

2.2.2 Temperature/humidity levels.

Although the combined 60°C and 95% RH does not occur in nature, these levels of temperature and relative humidity have historically provided an indication of potential problem areas in materiel.

2.3 Test Variations.

The most important ways the test can vary are in the number of temperature-humidity cycles, relative humidity, and temperature levels and durations, test item operation and performance monitoring, and test item ventilation.

2.4 Philosophy of Testing.

The purpose of the test procedure described in this method is to produce representative effects that typically occur when materiel is exposed to elevated temperature-humidity conditions in actual service. (See paragraph 2.1.1, above, for categories and examples of these effects.) Accordingly, this procedure does not reproduce naturally occurring or service-induced temperature-humidity time histories, nor is it intended to produce humidity effects that have been preceded by solar effects. It may induce problems that are indicative of long-term effects. Test item failures do not necessarily indicate failures in the real environment.

2.5 Alternative Tests.

If materiel specification documents suggest the use of natural or induced cycles as in AR 70-38 or NATO STANAG 2895 during laboratory tests, exercise caution in applying such cycles and in interpreting test results. The complex temperature/humidity environment with its associated antagonistic elements such as microbial growth, acidic atmosphere, and other biological elements produce synergistic effects that cannot be practically duplicated in the laboratory. Coupled with these test data interpretation problems are the extensive durations of real-world environments that, in most cases, are too lengthy to realistically apply in the laboratory.

3. INFORMATION REQUIRED.

3.1 Pretest.

The following information is required to conduct humidity tests adequately.

- a. General. Information listed in Part One, paragraphs 5.7 and 5.9, and Appendix A, Task 405 of this standard.
- b. Specific to this method.
 - (1) Any sealed areas of the test item to be opened during testing or vice versa.
 - (2) Periods of materiel operation or designated times for visual examinations.
 - (3) Operating test procedures, if appropriate.

3.2 During Test.

Collect the following information during conduct of the test:

- a. General. Information listed in Part One, paragraph 5.10, and in Appendix A, Task 406 of this standard.
- b. Specific to this method.
 - (1) Record of chamber temperature and humidity versus time conditions.
 - (2) Test item performance data and time/duration of checks.

3.3 Post Test.

The following post test information is required.

- a. General. Information listed in Part One, paragraph 5.13, and in Appendix A, Task 406 of this standard.
- b. Specific to this method.
 - (1) Previous test methods to which the test item has been subjected.
 - (2) Results of each performance check (before, during, and after test) and visual examination (and photographs, if applicable).

MIL-STD-810F
1 January 2000

- (3) Length of time required for each performance check.
- (4) Exposure durations and/or number of test cycles.
- (5) Test item configuration and special test setup provisions.

4. TEST PROCESS.

4.1 Test Facility.

Ensure the apparatus used in performing the humidity test includes the following:

4.1.1 General description.

The required apparatus consists of a chamber or cabinet, and auxiliary instrumentation capable of maintaining and monitoring (see Part One, paragraph 5.18) the required conditions of temperature and relative humidity throughout an envelope of air surrounding the test item. (See Part One, paragraph 5.)

4.1.2 Facility design.

Unless otherwise specified, use a test chamber or cabinet with a test volume and the accessories contained therein constructed and arranged in such a manner as to prevent condensate from dripping on the test item. Vent the test volume to the atmosphere to prevent the buildup of total pressure and prevent contamination from entering.

4.1.3 Test sensors and measurements.

Determine the relative humidity by employing either solid-state sensors whose calibration is not affected by water condensation, or by an equivalent method such as fast-reacting wet-bulb/dry-bulb sensors or dew point indicators. Sensors that are sensitive to condensation, such as the lithium chloride type, are not recommended for tests with high relative humidity levels. A data collection system, including an appropriate recording device(s), separate from the chamber controllers is necessary to measure test volume conditions. If charts are used, use charts readable to within $\pm 0.6^{\circ}\text{C}$. If the wet-wick control method is approved for use, clean the wet bulb and tank and install a new wick before each test and at least every 30 days. Ensure the wick is as thin as realistically possible to facilitate evaporation (approximately 1/16" thick) consistent with maintaining a wet surface around the sensor. Use water in wet-wick systems which is of the same quality as that used to produce the humidity. When physically possible, visually examine the water bottle, wick, sensor, and other components making up relative humidity measuring systems at least once every 24 hours during the test to ensure they are functioning as desired.

4.1.4 Air velocity.

Use an air velocity flowing across the wet-bulb sensor of not less than 4.6 meters/second (900 feet/minute), and ensure the wet wick is on the suction side of the fan to eliminate the effect of fan heat. Maintain the flow of air anywhere within the envelope of air surrounding the test item between 0.5 and 1.7 meters/second (98 to 335 feet/minute).

4.1.5 Humidity generation.

Use steam or water injection to create the relative humidity within the envelope of air surrounding the test item. Use water as described in Part One, paragraph 5.16. Verify its quality at periodic intervals (not to exceed 15 days) to ensure its acceptability. If water injection is used to humidify the envelope of air, temperature-condition it before its injection to prevent upset of the test conditions, and do not inject it directly into the test section. From the test volume drain and discard any condensate developed within the chamber during the test.

4.1.6 Contamination prevention.

Do not bring any material other than water into physical contact with the test item(s) that could cause the test item(s) to deteriorate or otherwise affect the test results. Do not introduce any rust or corrosive contaminants or any material other than water into the chamber test volume. Achieve dehumidification, humidification, heating and cooling of the

air envelope surrounding the test item by methods that do not change the chemical composition of the air, water, or water vapor within that volume of air.

4.2 Controls.

- a. Ensure the test chamber includes an appropriate measurement and recording device(s), separate from the chamber controllers.
- b. Test parameters. Unless otherwise specified, make continuous analog temperature and relative humidity measurements during the test. Conduct digital measurements at intervals of 15 minutes or less.
- c. Capabilities. Use only instrumentation with the selected test chamber that meets the accuracies, tolerances, etc., of Part One, paragraph 5.3.

4.3 Test Interruption.

- a. General. See Part One, paragraph 5.11, of this standard.
- b. Specific to this method.
 - (1) Undertest interruption. If an unscheduled interruption occurs that causes the test conditions to fall below allowable limits, the test must be reinitiated at the end of the last successfully completed cycle.
 - (2) Overtest interruptions. If the test item(s) is exposed to test conditions that exceed allowable limits, conduct an appropriate physical examination of the test item and perform an operational check (when practical) before testing is resumed. This is especially true where a safety condition could exist, such as with munitions. If a safety condition is discovered, the preferable course of action is to terminate the test and reinitiate testing with a new test item. If this is not done and test item failure occurs during the remainder of the test, the test results may be considered invalid. If no problem has been encountered, reestablish pre-interruption conditions and continue from the point where the test tolerances were exceeded.

4.4 Test Setup.

- a. General. See Part One, paragraph 5.8.
- b. Unique to this method. Verify that environmental monitoring and measurement sensors are of an appropriate type and properly located to obtain the required test data.

4.5 Test Execution.

The following steps, alone or in combination, provide the basis for collecting necessary information concerning the test item in a warm, humid environment.

4.5.1 Preparation for test.

4.5.1.1 Preliminary steps.

Before starting the test, determine the test details (e.g., procedure variations, test item configuration, cycles, durations, parameter levels for storage/operation, etc.) from the test plan.

4.5.1.2 Pretest standard ambient checkout.

All items require a pretest checkout at room ambient conditions to provide baseline data. Conduct the checkout as follows:

- Step 1. Install the test item into the test chamber and conduct an operational checkout (if appropriate) in accordance with the test plan.

MIL-STD-810F
1 January 2000

- Step 2. Prepare the test item in its required configuration in accordance with Part One, paragraph 5.8.1.
- Step 3. Conduct a thorough visual examination of the test item to look for conditions that could compromise subsequent test results.
- Step 4. Document any significant results.
- Step 5. Conduct an operational checkout (if appropriate) in accordance with the test plan, and record results.

4.5.2 Procedure.

This test consists of a 24-hour conditioning period (to ensure all items at any intended climatic test location will start with the same conditions), followed by a repeating 48-hour temperature and humidity cycle for the number of cycles specified in the test plan.

- Step 1. With the test item installed in the test chamber in its required configuration, adjust the temperature to $23 \pm 2^{\circ}\text{C}$ and $50 \pm 5\%$ RH, and maintain for 24 hours.
- Step 2. Adjust the chamber temperature to 30°C and the RH to 95%.
- Step 3. Expose the test item(s) to the appropriate number of test cycles (figure 507.4-1) as determined in paragraph 2.2.1. Conduct test item performance checks during the periods shown and document the results.
- Step 4. At the end of the required number of cycles, adjust the temperature and humidity conditions to standard ambient conditions.
- Step 5. In order to prevent unrealistic drying, within 15 minutes after Step 3 is completed, conduct an operational performance check, if applicable, and document the results. If the check cannot be completed within 30 minutes, recondition the test item at 30°C and 95% RH for one hour, and then continue the checkout.
- Step 6. Perform a thorough visual examination of the test item and document any conditions resulting from humidity exposure.

5. ANALYSIS OF RESULTS.

In addition to the guidance provided in Part One, paragraphs 5.14 and 5.17, the following information is provided to assist in the evaluation of the test results.

- a. Allowable or acceptable degradation in operating characteristics.
- b. Possible contributions from special operating procedures or special test provisions needed to perform testing.
- c. Whether it is appropriate to separate temperature effects from humidity effects.

6. REFERENCE/RELATED DOCUMENTS.

- a. AR 70-38, Research, Development, Test and Evaluation of Materiel for Extreme Climatic Conditions.
- b. MIL-HDBK-310, Global Climatic Data for Developing Military Products.
- c. Synopsis of Background Material for MIL-STD-210B, Climatic Extremes for Military Equipment, Bedford, MA: Air Force Cambridge Research Laboratories, 24 January 1974. DTIC number AD-780-508.
- d. STANAG 2895, Climatic Environmental Conditions Affecting the Design of Materiel for Use of NATO Forces.

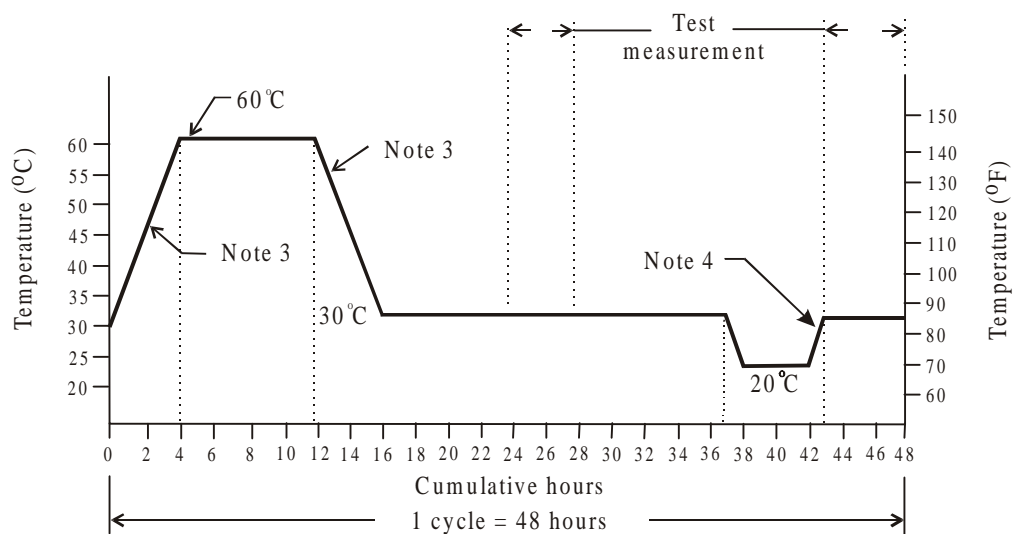

NOTES:

1. During temperature change, use a tolerance of not greater than 3°C (5°F).
2. Maintain the relative humidity at 95 ±4% at all times except that during the descending temperature periods the relative humidity may drop to as low as 85%.
3. Use a rate of temperature change between 30 and 60°C of not less than 8°C per hour.
4. Do not use a temperature increase in this portion of the curve that is less than 10°C per hour.

FIGURE 507.4-1. Aggravated temperature-humidity cycle.

MIL-STD-810F
1 January 2000

THIS PAGE INTENTIONALLY BLANK

ANNEX A

Physical Phenomena Associated with Humidity

1. CONDENSATION.

Precipitation of water vapor on a surface whose temperature is lower than the dew point of the ambient air. As a consequence, the water is transformed from the vapor state to the liquid state.

The dew point depends on the quantity of water vapor in the air. The dew point, the absolute humidity and the vapor pressure are directly interdependent. Condensation occurs on a test item when the temperature at the surface of the item placed in the test chamber is lower than the dew point of the air in the chamber. As a result, the item may need to be preheated to prevent condensation.

Generally speaking, condensation can only be detected with certainty by visual inspection. This, however, is not always possible, particularly with small objects having a rough surface. If the test item has a low thermal constant, condensation can only occur if the air temperature increases abruptly, or if the relative humidity is close to 100%. Slight condensation may be observed on the inside surface of box structures resulting from a decrease in the ambient temperature.

2. ADSORPTION.

Adherence of water vapor molecules to a surface whose temperature is higher than the dew point. The quantity of moisture that can adhere to the surface depends on the type of material, its surface condition, and the vapor pressure.

An estimation of the effects due solely to adsorption is not an easy matter because the effects of absorption, which occurs at the same time, are generally more pronounced.

3. ABSORPTION.

The accumulation of water molecules within material. The quantity of water absorbed depends, in part, on the water content of the ambient air. The process of absorption occurs continuously until equilibrium is reached. The penetration speed of the molecules in the water increases with temperature.

4. DIFFUSION.

Movement of water molecules through material caused by a difference in partial pressures. An example of diffusion often encountered in electronics is the penetration of water vapor through organic coatings such as those on capacitors or semiconductors, or through the sealing compound in the box.

5. BREATHING.

Air exchange between a hollow space and its surroundings caused by temperature variations. This commonly induces condensation inside the hollow space.

MIL-STD-810F
1 January 2000
ANNEX A

THIS PAGE INTENTIONALLY BLANK

METHOD 508.5

FUNGUS

NOTE: Tailoring is essential. Select methods, procedures and parameter levels based on the tailoring process described in Part One, paragraph 4, and Appendix C. Apply the general guidelines for laboratory test methods described in Part One, paragraph 5 of this standard.

1. SCOPE.

1.1 Purpose.

The purpose of this fungus test is to assess the extent to which materiel will support fungal growth and how any fungal growth may affect performance or use of the materiel. The primary objectives of the fungus test are to determine:

- a. if the materials comprising the materiel, or the assembled combination of same, will support fungal growth, and if so, of what species.
- b. how rapidly fungus will grow on the materiel.
- c. how fungus affects the materiel, its mission, and its safety for use following the growth of fungus on the materiel.
- d. if the materiel can be stored effectively in a field environment.
- e. if there are simple reversal processes, e.g., wiping off fungal growth.

1.2 Application.

Since microbial deterioration is a function of temperature and humidity and is an inseparable condition of hot, humid tropics and the midlatitudes, consider it in the design of all standard, general-purpose materiel. This method is used to determine if fungal growth will occur and, if so, how it may degrade/impact the use of the materiel.

NOTE: This test procedure and the accompanying preparation and post test analysis involve highly specialized techniques and potentially hazardous organisms. Use only technically qualified personnel (e.g., microbiologists) to perform the test.

1.3 Limitations.

This test is designed to obtain data on the susceptibility of materiel. Do not use it for testing of basic materials since various other test procedures, including soil burial, pure culture, mixed culture, and plate testing are available.

NOTE: Although the basic (documented) resistance of materials to fungal growth is helpful in the design of new materiel, the combination of materials, the physical structure of combined materials, and the possible contamination of resistant materials during manufacture necessitate laboratory or natural environment tests to verify the resistance of the assembled materiel to fungal growth.

2. TAILORING GUIDANCE.

2.1 Selecting the Fungus Method.

After examining requirements documents and applying the tailoring process in Part One of this standard to determine where fungal growth is anticipated in the life cycle of materiel, use the following to confirm the need for this method and to place it in sequence with other methods.

2.1.1 Effects of fungus growth.

Fungal growth impairs the functioning or use of materiel by changing its physical properties.

MIL-STD-810F
1 January 2000

2.1.1.1 Detrimental effects.

The detrimental effects of fungal growth are summarized as follows:

- a. **Direct attack on materials.** Nonresistant materials are susceptible to direct attack as the fungus breaks the materials down and uses them as nutrients. This results in deterioration affecting the physical properties of the material. Examples of nonresistant materials are:
 - (1) Natural material. Products of natural origin are most susceptible to this attack.
 - (a) Cellulosic materials (e.g., wood, paper, natural fiber textiles, and cordage).
 - (b) Animal- and vegetable-based adhesives.
 - (c) Grease, oils, and many hydrocarbons.
 - (d) Leather.
 - (2) Synthetic materials.
 - (a) PVC formulations (e.g., those plasticized with fatty acid esters).
 - (b) Certain polyurethanes (e.g., polyesters and some polyethers).
 - (c) Plastics that contain organic fillers of laminating materials.
 - (d) Paints and varnishes that contain susceptible constituents.
- b. Indirect attack on materials. Damage to fungus-resistant materials results from indirect attack when:
 - (1) Fungal growth on surface deposits of dust, grease, perspiration, and other contaminants (that find their way onto materiel during manufacture or accumulate during service) causes damage to the underlying material, even though that material may be resistant to direct attack.
 - (2) Metabolic waste products (i.e., organic acids) excreted by fungus cause corrosion of metals, etching of glass, or staining or degrading of plastics and other materials.
 - (3) The products of fungus on adjacent materials that are susceptible to direct attack come in contact with the resistant materials.

2.1.1.2 Physical interference.

Physical interference can occur as follows:

- a. Electrical or electronic systems. Damage to electrical or electronic systems may result from either direct or indirect attack. Fungi can form undesirable electrical conducting paths across insulating materials, for example, or may adversely affect the electrical characteristics of critically adjusted electronic circuits.
- b. Optical systems. Damage to optical systems results primarily from indirect attack. The fungus can adversely affect light transmission through the optical system, block delicate moving parts, and change nonwetting surfaces to wetting surfaces with resulting loss in performance.

2.1.1.3 Health and aesthetic factors.

Fungus on materiel can cause physiological problems (e.g., allergies) or be so aesthetically unpleasant that the users will be reluctant to use the materiel.

2.1.2 Sequence among other methods.

- a. General. See Part One, paragraph 5.5.
- b. Unique to this method. Because of the potentially unrepresentative combination of environmental effects, it is generally inappropriate to conduct this test on the same test sample previously subjected to salt fog, sand and dust, or humidity tests. However, if it is necessary, perform the fungus test before the salt fog or sand and dust tests. A heavy concentration of salt may affect the germinating fungus growth, and sand and dust can provide nutrients, thus leading to a false indication of the biosusceptibility of the test item.

2.2 Selecting Procedure Variations.

This method has one procedure. Since the combination of temperature and humidity is critical to microbial growth, it is essential that these be maintained as specified in the procedure. However, other possible variations are described below.

2.2.1 Test duration.

Twenty-eight days is the minimum test period to allow for fungus germination, breakdown of carbon-containing molecules, and degradation of material. Since indirect effects and physical interference are not likely to occur in the relatively short time frame of the fungus test, consider extension of the exposure period to 84 days if a greater degree of certainty (less risk) is required in determining the existence or effect of fungus growth.

2.2.2 Choice of fungus.

Two groups of fungus (U.S. and European) are commonly used and are listed in table 508.5-I. Use one group or the other and, if necessary, adjust it as in paragraph 2.2.2b. These organisms were selected because of their ability to degrade materials, their worldwide distribution and their stability. To aid in selection of a species to supplement the selected group, the organisms have, where possible, been identified with respect to the materials to which they are known to attack, and should be selected accordingly.

- a. Because the test item is not sterile before testing, other microorganisms will be present on the surfaces. When the test item is inoculated with the selected group of fungi, both these and the other organisms will compete for available nutrients. It is not surprising to see organisms other than the test fungi growing on the test item at the end of the test.
- b. Add additional species of fungus to those required in this test method. However, if additional fungi are used, base their selection on prior knowledge of specific material deterioration. For example, *Aureobasidium pullulans* was once employed because of its known specificity for degrading paints. (It has since been deleted from the suggested European species because of mutations to the strain.)

3. INFORMATION REQUIRED.

3.1 Pretest.

The following information is required to conduct fungus tests adequately.

- a. General. Information listed in Part One, paragraphs 5.7 and 5.9, and Appendix A, Task 405 of this standard.
- b. Specific to this method.
 - (1) Which set of fungi to be used (U.S. or European).
 - (2) Additional species to be added.

3.2 During Test.

Collect the following information during conduct of the test:

- a. General. Information listed in Part One, paragraph 5.10, and in Appendix A, Task 406 of this standard.
- b. Specific to this method.
 - (1) Record of chamber temperature and RH versus time conditions.
 - (2) Evidence of fungus growth on the cotton control strips at the 7-day check.
 - (3) Location of any fungal growth.

3.3 Post Test.

The following post test information is required.

MIL-STD-810F
1 January 2000

- a. General. Information listed in Part One, paragraph 5.13, and in Appendix A, Task 406 of this standard.
- b. Specific to this method.
 - (1) Evidence of fungus growth at the end of the test. If growth is found, identify the species.
 - (2) Narrative description of growth, including colors, areas covered, growth patterns, and density of growth (and photographs, if possible). (See table 508.5-II.)
 - (3) Effect of fungus on performance or use:
 - (a) As received from the chamber.
 - (b) After removal of fungus, if appropriate.
 - (c) Physiological or aesthetic considerations.
 - (4) Observations to aid in failure analysis.

4. TEST PROCESS.

4.1 Test Facility.

In addition to the standard requirements for test chambers, the following apply to chambers to be used for fungus tests.

4.1.1 Test chamber.

Construct the chamber and accessories in such a manner as to prevent condensation from dripping on the test item. Filter-vent the chamber to the atmosphere to prevent the buildup of pressure and release of spores into the atmosphere.

4.1.2 Sensors.

Monitor and control the humidity inside the test enclosure using psychrometric systems or with sensors that are not affected by condensation (see Part One, paragraph 5.18). Record the humidity and temperature using sensors separate from those used to control the chamber environment.

4.1.3 Air velocity.

Ensure the speed of the air across the psychrometric sensors is at least 4.5 m/s in order to achieve the required evaporation and sensor response. (If necessary to obtain this speed in the vicinity of the probe, use diffusers if desired.) However, control the air velocity in the vicinity of the test item and controls to between 0.5 and 1.7 m/sec (98 to 335 ft/min). Install deflectors or screens around the test item if necessary. In order to prevent heating of the psychrometer sensors, install the sensors either upstream of any fan used to create the air velocity, or far enough downstream not to be affected by fan motor heat.

4.2 Controls.

In addition to the information provided in Part One, paragraph 5, the following controls apply to this test.

4.2.1 Relative humidity.

In addition to the requirements appropriate for method 507.4, Humidity, and water purity as described in Part One, paragraph 5.16, determine the relative humidity by employing either solid state sensors whose calibration is not affected by water condensation, or by an approved equivalent method such as fast-reacting wet bulb/dry bulb sensors. Do not use lithium chloride sensors because of their sensitivity to condensation.

- a. When the wet bulb control method is used, clean the wet bulb assembly and install a new wick for each test.

- b. In order to produce the evaporation necessary for sensor measurement of wet bulb temperature, ensure the air velocity across the wet bulb is not less than 4.5 meters per second.
- c. Because heat from fan motors may affect temperature readings, do not install wet and dry bulb sensors close to the discharge side of any local fan or blower used to create the requirement of paragraph 4.2.1b.

4.2.2 Circulation.

Maintain free circulation of air around the test item and keep the contact area of fixtures supporting the test item to a minimum.

4.2.3 Steam.

Do not inject steam directly into the test chamber working space where it may have an adverse effect on the test item and microbial activity.

4.2.4 Unless otherwise specified:

- a. Use only reagents that conform to the specifications of the Committee on Analytical Reagents of the American Chemical Society, where such specifications are available.
- b. References to water means distilled water or water of equal purity. (See Part One, paragraph 5.16.)

4.3 Test Interruption.

- a. General. See Part One, paragraph 5.11, of this standard.
- b. Specific to this method. The fungus test, unlike other environmental tests, involves living organisms. If the test is interrupted, the fact that live organisms are involved must be considered.
 - (1) If the interruption occurs during the first ten days of the test, restart the test from the beginning with either a new or cleaned test item.
 - (2) If the interruption occurs late in the test cycle, examine the test item for evidence of fungus growth. If the test item is bio-susceptible, there is no need for a retest. If the controls exhibit viable growth but there is no evidence of fungus growth on the test item, follow the guidance given below.
 - (a) Lowered temperature. A lowering of the test chamber temperature generally will retard fungus growth. If the relative humidity has been maintained, reestablish the test conditions and continue the test from the point where the temperature fell below the prescribed tolerances. If not, see paragraph 4.3(c) below.
 - (b) Elevated temperature. Elevated temperatures may have a drastic effect on fungus growth. A complete re-initiation of the test is required if one of the following exists. Otherwise, reestablish test conditions and continue the test from the point of interruption.
 - the temperature exceeds 40°C, or
 - the temperature exceeds 31°C for 4 hours or more, or
 - there is evidence of deterioration of the fungus growth on the control strips.
 - (c) Lowered humidity. A complete retest is required if one of the following exists. Otherwise, reestablish test conditions and continue the test from the point of interruption.
 - the relative humidity drops below 50%, or
 - the relative humidity drops below 70% for 4 hours or more, or
 - there is evidence of deterioration of the fungal colonies on the control strips.

MIL-STD-810F
1 January 2000

4.4 Execution.

4.4.1 Cleaning.

Although it is preferable to use a new test item, the same test item as used in other tests may be used. If cleaning is required, conduct the cleaning at least 72 hours before test initiation in order to allow evaporation of any volatile materials. Clean using typical production cleaning methods. Prepare the test item in accordance with paragraph 4.5.1. Place new cotton control strips in the test chamber and inoculate both the test item and the controls with the test fungi.

4.4.2 Miscellaneous.

- a. This method is designed to provide optimal climatic conditions and all of the basic inorganic minerals needed for growth of the fungal species used in the test. The group of fungal species was chosen for its ability to attack a wide variety of materials commonly used in the construction of military materiel. Optional species may be added to the inoculum, if required (see paragraph 2.2.2).
- b. This test must be performed by trained personnel at laboratories specially equipped for microbiological work.
- c. The presence of moisture is essential for spore germination and growth. Generally, germination and growth will start when the relative humidity of the ambient air exceeds 70%. Development will become progressively more rapid as the humidity rises above this value, reaching a maximum in the 90 to 100% relative humidity range.
- d. The specified temperature of $30 \pm 1^{\circ}\text{C}$ ($86 \pm 2^{\circ}\text{F}$) is most conducive to the growth of the test fungi.
- e. Control items specified in paragraph 4.4.3.3 are designed to:
 - (1) verify the viability of the fungus spores used in the inoculum.
 - (2) establish the suitability of the chamber environment to support fungus growth.
- f. Although this procedure can provide information on the susceptibility of materials to fungus growth, the testing of materials and piece parts will not reveal potential fungus growth situations in materiel. These can result due to the complexities involved in assemblages. Examples are induced conditions created by coatings and protective wrappings, deterioration of protective coatings due to bi-metallic reactions, and other situations that would not be encountered with the testing of components.

4.4.3 Preparation for test.**4.4.3.1 Preparation of mineral salts solution.**

- a. Using clean apparatus, prepare the mineral salts solution to contain the following:

| | |
|---|--------|
| Potassium dihydrogen orthophosphate (KH ₂ PO ₄) | 0.7g |
| Potassium monohydrogen orthophosphate (K ₂ HPO ₄). | 0.7g |
| Magnesium sulfate heptahydrate (MgSO ₄ ·7H ₂ O) | 0.7g |
| Ammonium nitrate (NH ₄ NO ₃) | 1.0g |
| Sodium chloride (NaCl) | 0.005g |
| Ferrous sulfate heptahydrate (FeSO ₄ ·7H ₂ O) | 0.002g |
| Zinc sulfate heptahydrate (ZnSO ₄ ·7H ₂ O) | 0.002g |
| Manganous sulfate monohydrate (MnSO ₄ ·H ₂ O) | 0.001g |
| Distilled water | 1000ml |

- b. The pH of the mineral salts solution must be between 6.0 and 6.5.

4.4.3.2 Preparation of mixed spore suspension.

NOTE - PRECAUTIONS: Although the exact strains of fungus specified for this test are not normally considered to present a serious hazard to humans, certain people may develop allergies or other reactions. Therefore, use standing operating procedures for safety. Also, use only personnel trained in microbiological techniques to conduct the tests.

- a. Use aseptic techniques to prepare the spore suspension containing at least the test fungi determined from paragraph 2.2.2.
- b. Maintain pure cultures of these fungi separately on an appropriate medium such as potato dextrose agar, but culture *Chaetomium globosum* on strips of filter paper overlaid on the surface of mineral salts agar. Prepare the mineral salts agar by dissolving 15.0g of agar in a liter of the mineral salts solution described in paragraph 4.4.3.1.

NOTE: Do not keep the stock cultures for more than 4 months at 6 ±4°C; after that time, prepare subcultures and use them for the new stocks.

- c. Verify the purity of fungus cultures before the test.
- d. Make subcultures from the pure stock cultures and incubate them at 30 ±1°C for 10 to 21¹ days.
- e. Prepare a spore suspension of each of the required test fungus by pouring into one subculture of each fungus 10 ml of an aqueous solution containing 0.05g per liter of a nontoxic wetting agent such as sodium dioctyl sulfosuccinate or sodium lauryl sulfate.
- f. Use a rounded glass rod or a sterilized platinum or nickel chrome wire to gently scrape the surface growth from the culture of the test organisms.
- g. Pour the spore charge into a 125 ml capped Erlenmeyer flask containing 45 ml of water and 50 to 75 solid glass beads, 5mm in diameter.
- h. Shake the flask vigorously to liberate the spores from the fruiting bodies and to break the spore clumps.
- i. Filter the dispersed fungal spore suspension into a flask through a 6 mm layer of glass wool contained in a glass funnel.

NOTE: This process should remove large mycelial fragments and clumps of agar.

¹ Most fungi will develop within 10 to 14 days and may show signs of deterioration after longer incubation. Some fungi such as *Chaetomium globosum* require 21 days or longer to develop.

MIL-STD-810F
1 January 2000

- j. Centrifuge the filtered spore suspension and discard the supernatant liquid.
- k. Re-suspend the residue in 50 ml of water and centrifuge. Wash the spores obtained from each of the fungi in this manner at least three times (until the supernatant is clear).
- l. Dilute the final washed residue with mineral-salts solution in such a manner that the resultant spore suspension contains $1,000,000 \pm 20\%$ spores per milliliter as determined with a counting chamber.
- m. Repeat this operation for each organism used in the test.
- n. Perform a viability check for each organism in accordance with paragraph 4.4.3.3.
- o. Blend equal volumes of the resultant spore suspension to obtain the final mixed spore suspension.

NOTE: Use a freshly prepared spore suspension. If not freshly prepared, it must be held at $6 \pm 4^\circ\text{C}$ for not more than 14 days.

4.4.3.3 Control items.

Two types of control tests are required. Using the following procedures, verify the viability of the spore suspension and its preparation, as well as the suitability of the chamber environment.

- a. Viability of spore suspension
 - (1) Before preparing the composite spore suspension, inoculate sterile potato dextrose or another nutrient agar plates with 0.2 to 0.3 ml of the spore suspension of each of the individual fungus species. Use separate agar plates for each species.
 - (2) Distribute the inoculum over the entire surface of the plate.
 - (3) Incubate the inoculated potato dextrose agar plate at $30 \pm 1^\circ\text{C}$ for 7 to 10 days.
 - (4) After the incubation period, check the fungus growth.

NOTE: The absence of copious growth of any of the test organisms over the entire surface in each container will invalidate the results of any tests using these spores.

- b. Test chamber environment
 - (1) Prepare the following solution:
 - 10.0g glycerol
 - 0.1g potassium dihydrogen orthophosphate (KH_2PO_4).
 - 0.1g ammonium nitrate (NH_4NO_3).
 - 0.025g magnesium sulfate heptahydrate ($\text{MgSO}_4 \cdot 7\text{H}_2\text{O}$).
 - 0.05g yeast extract.
 - Distilled water to a total volume of 100 ml.
 - 0.005g of a nontoxic wetting agent such as sodium dioctyl sulfosuccinate or sodium lauryl sulfate.
 - HCl and NaOH to adjust the final solution pH to 5.3.
 - (2) Prepare control strips from unbleached, plain weave, 100% cotton cloth that has been cut or torn into strips about 3 cm wide. Use only strips devoid of fungicides, water repellents and sizing additives. To aid in removing any possible treatment materials, recommend boiling in distilled water. Dip the strips into the above solution. After dipping, remove the excess liquid from the strips and hang them to dry before placing them in the chamber and inoculating. Ensure the strips have been thoroughly wetted.
 - (3) Within the chamber, place the strips vertically close to and bracketing the test items to ensure the test strips and test items experience the same test environment. Use strips at least as long as the test item is high.

- (4) To ensure proper conditions are present in the incubation chamber to promote fungus growth, install these strips and inoculate them along with the test item.

4.5 Test Procedure.

4.5.1 Preparation for incubation.

- Step 1. Assure the condition of the items subjected to testing is similar to their condition as delivered by the manufacturer or customer for use, or as otherwise specified. Accomplish any cleaning of the test item at least 72 hours before the beginning of the fungus test to allow for evaporation of volatile materials.
- Step 2. Install the test item in the chamber or cabinet on suitable fixtures, or suspend them from hangers.
- Step 3. Hold the test item in the operating chamber (at $30 \pm 1^\circ\text{C}$ and a RH of greater than 90% but less than 100%) for at least four hours immediately before inoculation.
- Step 4. Inoculate the test item and the cotton fabric chamber control items with the mixed fungus spore suspension by spraying the suspension on the control items, and on and into the test item(s) (if not permanently or hermetically sealed) in the form of a fine mist from an atomizer or nebulizer. Ensure personnel with appropriate knowledge of the test item are available to aid in exposing its interior surfaces for inoculation.

NOTE: In spraying the test and control items with composite spore suspension, cover all external and internal surfaces that are exposed during use or maintenance. If the surfaces are non-wetting, spray until drops begin to form on them.

- Step 5. In order for air to penetrate, replace the covers of the test items without tightening the fasteners.
- Step 6. Start incubation immediately following the inoculation.

4.5.2 Incubation of the test item.

- Step 7. Except as noted in Step 2 below, incubate the test items at constant temperature and humidity conditions of $30 \pm 1^\circ\text{C}$ and a relative humidity above 90% but below 100% for the test duration (28 days, minimum).
- Step 8. After 7 days, inspect the growth on the control cotton strips to verify the environmental conditions in the chamber are suitable for growth. At this time at least 90 percent of the part of the surface area of each test strip located at the level of the test item should be covered by fungus. If it is not, repeat the entire test with the adjustments of the chamber required to produce conditions suitable for growth. Leave the control strips in the chamber for the duration of the test.
- Step 9. If the cotton strips show satisfactory fungus growth after 7 days, continue the test for the required period from the time of inoculation as specified in the test plan. If there is no increase in fungus growth on the cotton strips at the end of the test as compared to the 7-day results, the test is invalid.

4.5.3 Inspection.

At the end of the incubation period, inspect the test item immediately. If possible, inspect the item within the chamber. If the inspection is conducted outside of the chamber and is not completed in 8 hours, return the test item to the test chamber or to a similar humid environment for a minimum of 12 hours. Except for hermetically sealed materiel, open the test item enclosure and examine both the interior and exterior of the test item. Record the results of the inspection.

4.5.4 Operation/use.

(To be conducted only if required.) If operation of the test item is required (e.g., electrical materiel), conduct the operation in the period as specified in paragraph 4.5.3. Ensure personnel with appropriate knowledge of the test item are available to aid in exposing its interior surfaces for inspection and in making operation and use decisions. Disturbance of any fungus growth must be kept to a minimum during the operational checkout.

MIL-STD-810F
1 January 2000

5. ANALYSIS OF RESULTS.

In addition to the guidance provided in Part One, paragraphs 5.14 and 5.17, the following information is provided to assist in the evaluation of the test results.

- a. Any fungal growth on the test item must be analyzed to determine the species, and if the growth is on the test item material(s) or on contaminants.
- b. Any fungal growth on the test item material(s), whether from the inoculum or other sources, must be evaluated by qualified personnel for:
 - (1) The extent of growth on susceptible components or materials. Use table 508.5-II as a guide for this evaluation, but any growth must be completely described.
 - (2) The immediate effect that the growth has on the physical characteristics of the materiel.
 - (3) The long-range effect that the growth could have on the materiel.
 - (4) The specific material (nutrient(s)) supporting the growth.
- c. Evaluate human factors effects (including health risks).

6. REFERENCE/RELATED DOCUMENTS.

None.

TABLE 508.5-I. Test fungus.

| Fungus | Fungus Sources Identification No. | | Standard | Materials affected |
|-----------------------------------|-----------------------------------|--------------------------------------|----------|---|
| | USDA ^{2/} | ATCC ^{3/} | | |
| <i>Aspergillus niger</i> | QM 458 | ATCC 6275 | Europe | Textiles, vinyl, conformal coatings, insulation, etc. resistant to tanning salts |
| <i>Aspergillus terreus</i> | QM 82j | ATCC 10690 | Europe | Haversack, paperboard, paper |
| <i>Paecilomyces varioti</i> | | IAM 5001 ^{4/} ATCC 18502 | Europe | Plastics, leather |
| <i>Penicillium funiculosum</i> | | IAM 7013 ^{3/} ATCC 36839 | Europe | Textiles, plastics, cotton fabric |
| <i>Penicillium ochro-chloron</i> | QM 477 | ATCC 9112 | Europe | Plastics, textiles |
| <i>Scopulariopsis brevicaulis</i> | | IAM 5146 ^{3/} | Europe | Rubber |
| <i>Trichoderme viride</i> | | IAM 5061 ^{3/} ATCC 9645 | Europe | Plastics, textiles |
| <i>Aspergillus flavus</i> | QM 380 | ATCC 9643 | U.S. | Leathers, textiles |
| <i>Aspergillus versicolor</i> | QM 432 | ATCC 11730 | U.S. | Leather |
| <i>Penicillium funiculosum</i> | QM 474 | ATCC 11797 | U.S. | Textiles, plastics, cotton fabric |
| <i>Chaetomium globosum</i> | QM 459 | ATCC 6205 | U.S. | Cellulose |
| <i>Aspergillus niger</i> | QM 386 | ATCC 9642 | U.S. | Textiles, vinyl, conformal coatings, insulation, etc. resistant to tanning salts |

^{2/} U.S. Department of Agriculture, Northern Regional Research Center, ARS Culture Collection, 1815 North University Street, Peoria, IL 61604. (The fungus may be distributed in a lyophilized state or on agar slants.)

^{3/} American Type Culture Collection, 12301 Parklawn Drive, Rockville MD 20852.

^{4/} Institute of Applied Microbiology, University of Tokyo, Tokyo, Japan

MIL-STD-810F
1 January 2000

TABLE 508.5-II. Evaluation scheme for visible effects.^{1/}

| Amount of Growth | Rating | Comments |
|-------------------------|---------------|---|
| None | 0 | Substrate is devoid of microbial growth. |
| Trace | 1 | Scattered, sparse or very restricted microbial growth. |
| Light | 2 | Intermittent infestations or loosely spread microbial colonies on substrate surface. Includes continuous filamentous growth extending over the entire surface, but underlying surfaces are still visible. |
| Medium | 3 | Substantial amount of microbial growth. Substrate may exhibit visible structural change. |
| Heavy | 4 | Massive microbial growth. |

^{1/} Use this scheme as a guide, but exceptions may occur which require a more specific description.

METHOD 509.4

SALT FOG

NOTE: Tailoring is essential. Select methods, procedures, and parameter levels based on the tailoring process described in Part One, paragraph 4.2.2, and Appendix C. Apply the general guidelines for laboratory test methods described in Part One, paragraph 5 of this standard.

1. SCOPE.

1.1 Purpose.

The salt fog method is performed to determine the effectiveness of protective coatings and finishes on materials. It may also be applied to determine the effects of salt deposits on the physical and electrical aspects of materiel.

1.2 Application.

Use this method for screening purposes only to evaluate the effectiveness and quality of protective coatings and finishes on materiel and material coupons, and to locate potential problem areas, quality control deficiencies, design flaws, etc., in a relatively short period of time. In general, only apply this method to materiel that will experience significant exposure (as opposed to infrequent or irregular) to high levels of salt in the atmosphere.

1.3 Limitations.

- a. The test is not intended to duplicate the effects of a marine atmosphere due to variations in chemical composition and concentrations of the various marine and other corrosive environments.
- b. It has not been demonstrated that a direct relationship exists between salt fog corrosion and corrosion due to other media.
- c. It has not been demonstrated that withstanding the effects of this test guarantees materiel will survive under all corrosive conditions.
- d. This test has proven to be generally unreliable for predicting the service life of different materials or coatings.
- e. This test is not a substitute for evaluating corrosion caused by humidity and fungus because their effects differ from salt fog effects and the tests are not interchangeable.
- f. This test is not intended to be used for sample or coupon testing in lieu of assemblage testing.

2. TAILORING GUIDANCE.

2.1 Selecting the Salt Fog Method.

After examining requirements documents and applying the tailoring process in Part One of this standard to determine where atmospheric corrosion is anticipated in the life cycle of materiel, use the following to confirm the need for this method and to place it in sequence with other methods.

2.1.1 Effects of corrosive environments.

Salt is one of the most pervasive chemical compounds in the world. It is found in the oceans, the atmosphere, ground surfaces, and lakes and rivers. It is impossible to avoid exposure to salt. The worst effects occur, in general, in coastal regions. The effects of exposure of materiel to an environment where there is a corrosive atmosphere can

MIL-STD-810F
1 January 2000

be divided into three broad categories: corrosion effects, electrical effects, and physical effects. Consider the following typical problems to help determine if this method is appropriate for the materiel being tested. This list is not intended to be all-inclusive.

2.1.1.1 Corrosion effects.

- a. Corrosion due to electrochemical reaction.
- b. Accelerated stress corrosion.
- c. Formation of acidic/alkaline solutions following salt ionization in water.

2.1.1.2 Electrical effects.

- a. Impairment of electrical materiel due to salt deposits.
- b. Production of conductive coatings.
- c. Corrosion of insulating materials and metals.

2.1.1.3 Physical effects.

- a. Clogging or binding of moving parts of mechanical components and assemblies.
- b. Blistering of paint as a result of electrolysis.

2.1.2 Sequence among other methods.

- a. General. See Part One, paragraph 5.5.
- b. Unique to this method. If using the same test item sample for more than one climatic test, in most cases recommend the salt fog test be conducted after the other climatic tests. Salt deposits can interfere with the effects of other tests. It is generally inappropriate to conduct the salt fog, fungus and humidity tests on the same test sample because the accumulation of effects from the three environments may be unrealistic. However, if it is necessary to do so, perform the salt fog test following the fungus and humidity tests. Although generally inappropriate, if sand and dust testing is required on the same test item, perform it following salt fog testing.

2.2 Selecting Procedure Variations.

This method has one procedure. Possible variations are described below.

2.2.1 Salt solution.

Unless otherwise identified, use a $5 \pm 1\%$ salt solution concentration (reference d.). Use water as described in Part One, paragraph 5.16. The intent is to not introduce contaminants or acidic/alkaline conditions that may affect the test results. (See paragraph 4.5.1.1.b.)

2.2.2 Test item configuration.

The configuration and orientation of the test item during the exposure period of the salt fog test is an important factor in determining the effect of the environment on the test item. Unless otherwise specified, configure the test item and orient it as would be expected during its storage, shipment, or use. The listing below offers the most likely configurations that materiel would assume when exposed to a corrosive atmosphere. For test purposes, choose the most severe/critical configuration.

- a. In a shipping/storage container or transit case.

- b. Outside of its shipping/storage container but provided with an effective environmental control system that partly excludes the salt fog environment.
- c. Outside of its shipping/storage container and set up in its normal operating mode.
- d. Modified with kits for special applications or to compensate for mating components that are normally present, but are not used for this specific test.

2.2.3 Duration.

The standard exposure of 48 hours of exposure and 48 hours of drying time has not changed. However, experience has shown that alternating 24-hour periods of salt fog exposure and drying conditions for a minimum of four 24-hour periods (two wet and two dry), provides more realistic exposure and a higher damage potential than does continuous exposure to a salt atmosphere (reference d.). Because the rate of corrosion is much higher during the transition from wet to dry, it is critical to closely control the rate of drying if corrosion levels from test to test are to be compared. The number of cycles may be increased, if appropriate.

2.2.4 Temperature.

Maintain the temperature in the exposure zone at $35 \pm 2^{\circ}\text{C}$ ($95 \pm 4^{\circ}\text{F}$). This temperature has been historically accepted and is not intended to simulate actual exposure situations. Other temperatures may be used if appropriate.

2.2.5 Air circulation.

Ensure the air velocity in test chambers is minimal (essentially zero).

2.2.6 Fallout rate.

Adjust the salt fog fallout such that each receptacle collects from 1 to 3 ml of solution per hour for each 80 cm^2 of horizontal collecting area (10 cm diameter).

3. INFORMATION REQUIRED.

3.1 Pretest.

The following information is required to conduct salt fog tests adequately.

- a. General. Information listed in Part One, paragraphs 5.7 and 5.9, and Appendix A, Task 405 of this standard.
- b. Specific to this method.
 - (1) Areas of the test item visually and functionally examined and an explanation of their inclusion or exclusion.
 - (2) Salt concentration if other than 5%.
 - (3) Resistivity of initial water and type of water.

3.2 During Test.

Collect the following information during conduct of the test:

- a. General. Information listed in Part One, paragraph 5.10, and in Appendix A, Task 406 of this standard.
- b. Specific to this method.
 - (1) Record of chamber temperature versus time conditions.
 - (2) Salt fog fallout quantities per unit of time (paragraph 4.1.4).
 - (3) Salt fog pH (paragraph 4.5.1.1b).

MIL-STD-810F
1 January 2000

3.3 Post Test.

The following post test information is required.

- a. General. Information listed in Part One, paragraph 5.13, and in Appendix A, Task 406 of this standard.
- b. Specific to this method.
 - (1) Areas of the test item visually and functionally examined and an explanation of their inclusion or exclusion.
 - (2) Test variables:
 - (a) Salt solution pH.
 - (b) Salt solution fallout rate (ml/cm²/hr).
 - (3) Results of examination for corrosion, electrical, and physical effects.
 - (4) Observations to aid in failure analysis.

4. TEST PROCESS.

4.1 Test Facility.

Ensure the apparatus used in performing the salt fog test includes the following.

4.1.1 Test chamber.

Use supporting racks that do not affect the characteristics of the salt fog mist. All parts of the test setup that contact the test item must not cause electrolytic corrosion. Do not allow condensation to drip on the test item. Do not return to the salt solution reservoir any liquid that comes in contact with either the chamber or the test item. Vent the exposure area to prevent pressure buildup. Ensure the test chamber has a waste collection system so that all waste material can be tested prior to disposal. Dispose of any material determined to be hazardous waste in accordance with local, state and federal regulations.

4.1.2 Salt solution reservoir.

Ensure the salt solution reservoir is made of material that is non-reactive with the salt solution, e.g., glass, hard rubber, or plastic.

4.1.3 Salt solution injection system.

Filter the salt solution (figures 509.4-2 and -3) and inject it into the test chamber with atomizers that produce a finely divided, wet, dense fog. Use atomizing nozzles and a piping system made of material that is non-reactive to the salt solution. Do not let salt buildup clog the nozzles.

NOTE: Suitable atomization has been obtained in chambers having a volume of less than .34m³ (12 ft³) under the following conditions:

- a. Nozzle pressure as low as practical to produce fog at the required rate.
- b. Orifices between 0.5 and 0.76 mm (0.02 and 0.03 in) in diameter.
- c. Atomization of approximately 2.8 liters of salt solution per 0.28m³ (10 ft³) of chamber volume per 24 hours.

When chambers with a volume considerably in excess of 0.34m³ (12 ft³) are used, the conditions specified may require modification.

4.1.4 Salt fog collection receptacles.

Use a minimum of 2 salt fog collection receptacles to collect water solution samples. Locate one at the perimeter of the test item nearest to the nozzle, and the other also at the perimeter of the test item but at the farthest point from the

nozzle. If using multiple nozzles, the same principles apply. Position the receptacles such that they are not shielded by the test item and will not collect drops of solution from the test item or other sources.

4.2 Controls.

Preheat the oil-free and dirt-free compressed air used to produce the atomized solution (to offset the cooling effects of expansion to atmospheric pressure) and pre-humidify it such that the temperature is $35 \pm 2^\circ\text{C}$ and the relative humidity is in excess of 85% at the nozzle (see table 509.4-I).

TABLE 509.4-I. Air pressure and preheat temperature requirements for operation at 35°C .

| Air Pressure (kPa) | 83 | 96 | 110 | 124 |
|--|----|----|-----|-----|
| Preheat temperature ($^\circ\text{C}$) (before atomizing) | 46 | 47 | 48 | 49 |

4.3 Test Interruption.

- a. General. See Part One, paragraph 5.11, of this standard.
- b. Specific to this method.
 - (1) Undertest interruption. If an unscheduled test interruption occurs that causes the test conditions to exceed allowable tolerances toward standard ambient conditions, give the test item a complete visual examination and develop a technical evaluation of the impact of the interruption on the test results. Restart the test at the point of interruption and restabilize the test item at the test conditions.
 - (2) Overtest interruption. If an unscheduled test interruption occurs that causes the test conditions to exceed allowable tolerances away from standard ambient conditions, stabilize the test conditions to within tolerances and hold them at that level until a complete visual examination and technical evaluation can be made to determine the impact of the interruption on test results. If the visual examination or technical evaluation results in a conclusion that the test interruption did not adversely affect the final test results, or if the effects of the interruption can be nullified with confidence, restabilize the pre-interruption conditions and continue the test from the point where the test tolerances were exceeded.

4.4 Test Setup.

- a. General. See Part One, paragraph 5.8.
- b. Unique to this method. Ensure the fallout collection containers are situated in the chamber such that they will not collect fluids dripping from the test item.

4.5 Test Execution.

The following steps, alone or in combination, provide the basis for collecting necessary information concerning the test item in a salt fog environment.

4.5.1 Preparation for test.

4.5.1.1 Preliminary steps.

Before starting the test, determine the test details (e.g., procedure variations, test item configuration, cycles, durations, parameter levels for storage/operation, etc.) from the test plan. (See paragraph 3.1 above.)

- a. Handling and configuration.
 - (1) Handle the test item as little as possible. Prepare the test item for testing immediately before exposure. Unless otherwise specified, ensure the test item surfaces are free of surface contamination such as oil, grease, or dirt that could cause a water break. Do not use corrosive solvents, solvents

MIL-STD-810F
1 January 2000

which deposit either corrosive or protective films, or abrasives other than a paste of pure magnesium oxide in any cleaning methods.

- (2) Configure the test item as specified in the test plan and insert it into the test chamber.
- b. Preparation of salt solution. For this test, use sodium chloride containing (on a dry basis) not more than 0.1% sodium iodide and not more than 0.5% total impurities. Do not use sodium chloride containing anti-caking agents because such agents may act as corrosion inhibitors. Unless otherwise specified, prepare a $5 \pm 1\%$ solution by dissolving 5 parts by weight of salt in 95 parts by weight of water. Adjust to and maintain the solution at a specific gravity (figure 509.4-1) by using the measured temperature and density of the salt solution. If necessary, add sodium tetraborate (borax) to the salt solution as a pH stabilization agent in a ratio not to exceed 0.7g sodium tetraborate to 75 liters of salt solution. Maintain the pH of the salt solution, as collected as fallout in the exposure chamber, between 6.5 and 7.2 with the solution temperature at $+35 \pm 2^\circ\text{C}$. To adjust the pH, use only diluted chemically pure hydrochloric acid or chemically pure sodium hydroxide. Make the pH measurement either electrometrically or calorimetrically.
- c. Chamber operation verification. Unless the chamber has been used within five days or the nozzle becomes clogged, immediately before the test and with the exposure chamber empty, adjust all test parameters to those required for the test. Maintain these conditions for at least one 24-hour period or until proper operation and salt fog collection can be verified. Continuously monitor all test parameters to verify the test chamber is operating properly.

4.5.1.2 Pretest standard ambient checkout.

All items require a pretest checkout at room ambient conditions to provide baseline data. Conduct the checkout as follows:

- Step 1. Prepare the test item in its required configuration in accordance with Part One, paragraph 5.8.1.
- Step 2. Record the room ambient conditions.
- Step 3. Conduct a complete visual examination of the test item with attention to:
- (1) High-stress areas.
 - (2) Areas where dissimilar metals are in contact.
 - (3) Electrical and electronic components - especially those having closely spaced, unpainted or exposed circuitry.
 - (4) Metallic surfaces.
 - (5) Enclosed volumes where condensation has occurred or may occur.
 - (6) Components or surfaces provided with coatings or surface treatments for corrosion protection.
 - (7) Cathodic protection systems; mechanical systems subject to malfunction if clogged or coated with salt deposits.
 - (8) Electrical and thermal insulators.

NOTE: Consider partial or complete disassembly of the test item if a complete visual examination is required. Be careful not to damage any protective coatings, etc.

- Step 4. Document the results. (Use photographs, if necessary.)
- Step 5. Conduct an operational checkout in accordance with the test plan and record the results for compliance with Part One, paragraph 5.9.
- Step 6. If the test item meets the requirements of the test plan or other applicable documents, proceed to Step 1 of the test procedure below. If not, resolve any problems and restart the pretest standard ambient checkout at the most reasonable step above.

4.5.2 Procedure.

- Step 1. Adjust the test chamber temperature to 35°C and condition the test item for at least two hours before introducing the salt fog.

- Step 2. Continuously atomize a salt solution of a composition as given in 4.4.1.1b into the test chamber for a period of 24 hours or as specified in the test plan. During the entire exposure period measure the salt fog fallout rate and pH of the fallout solution at least at 24-hour intervals^{1/}. Ensure the fallout is between 1 and 3 ml/80cm²/hr.
- Step 3. Dry the test item at standard ambient temperatures and a relative humidity of 50% or less for 24 hours. Do not disturb the test item or adjust any mechanical features during the drying period.
- Step 4. At the end of the drying period and unless otherwise specified, replace the test item in the salt fog chamber and repeat steps 2 and 3.
- Step 5. Visually inspect the test item in accordance with the guidelines given in paragraph 4.4.1.2.
- Step 6. After completing the physical and electrical checkout, document the results (with photographs if necessary). Then, if necessary to aid in the following corrosion examination, use a gentle wash in running water, which is at standard ambient conditions.

5. ANALYSIS OF RESULTS.

In addition to the guidance provided in Part One, paragraphs 5.14 and 5.17, the following information is provided to assist in the evaluation of the test results.

- a. Physical. Salt deposits can cause clogging or binding of mechanical components and assemblies. The extent of any deposits resulting from this test may be representative of those induced by anticipated environments.
- b. Electrical. Moisture remaining after the 24-hour drying period could cause electrical malfunctions. If so, attempt to relate the malfunctions to that possible in service.
- c. Corrosion. Analyze any corrosion for its immediate and potential long-term effects on the proper functioning and structural integrity of the test item.

6. REFERENCE/RELATED DOCUMENTS.

- a. AR 70-38, Research, Development, Test and Evaluation of Materiel for Extreme Climatic Conditions.
- b. MIL-HDBK-310, Global Climatic Data for Developing Military Products.
- c. Army Materiel Command Pamphlet AMCP-706-116, Engineering Design Handbook, Environmental Factors.
- d. Final Letter Report of Methodology Investigation on Evaluation of Test Procedures Used for Salt Fog Tests, TECOM Project 7-CO-PB7-API-018, Aberdeen Proving Ground, MD 21005; July 1979.

^{1/} Recommend more frequent intervals. Repeat the interval if fallout quantity requirements are not met.

MIL-STD-810F
1 January 2000

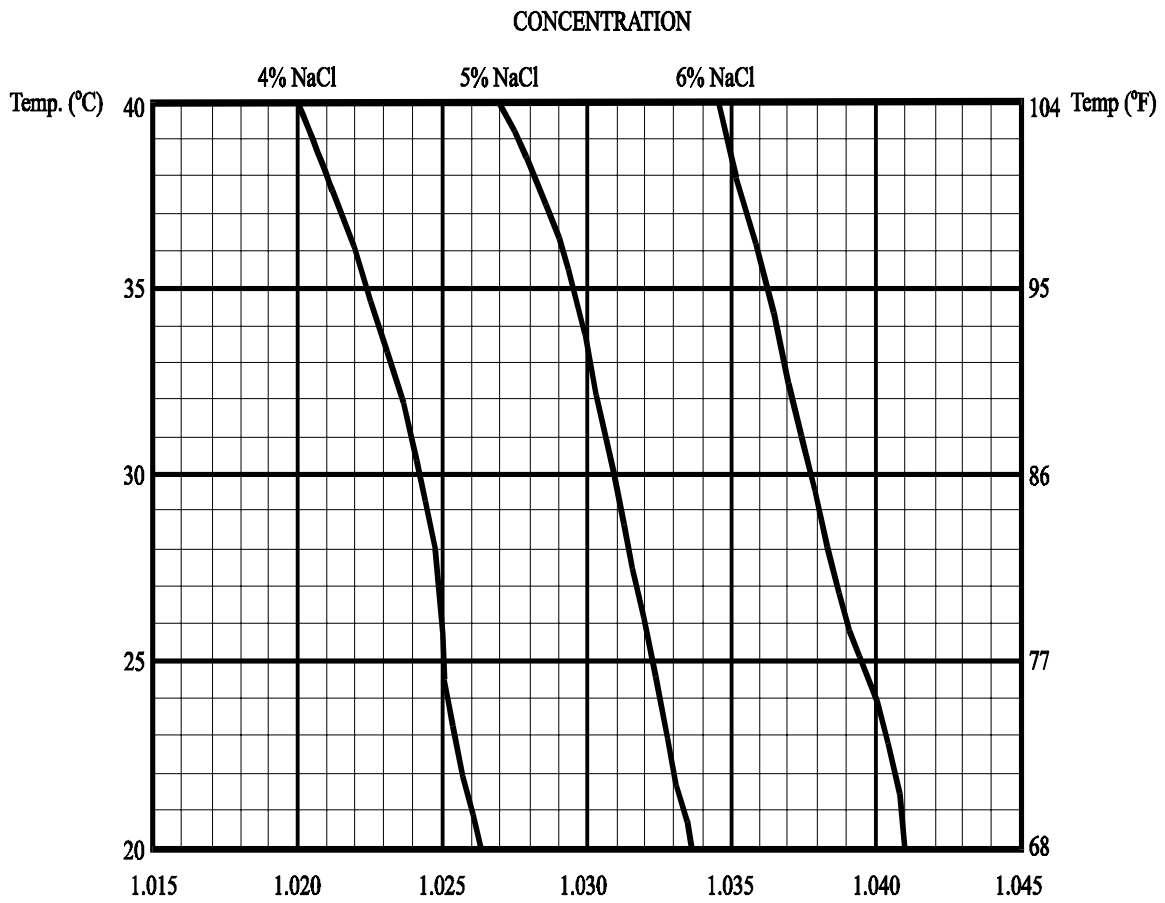

FIGURE 509.4-1. Variations of specific gravity of salt (NaCl) solution with temperature.

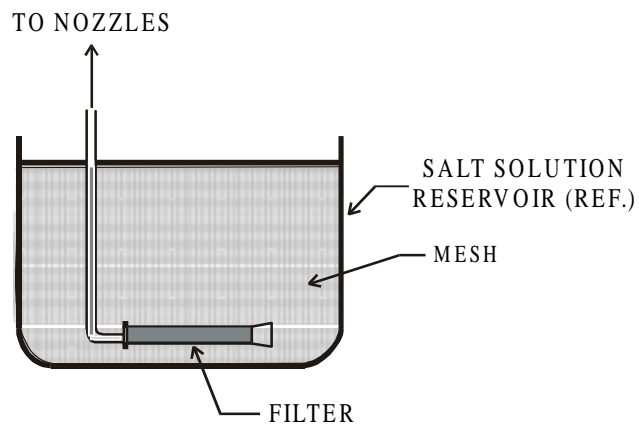
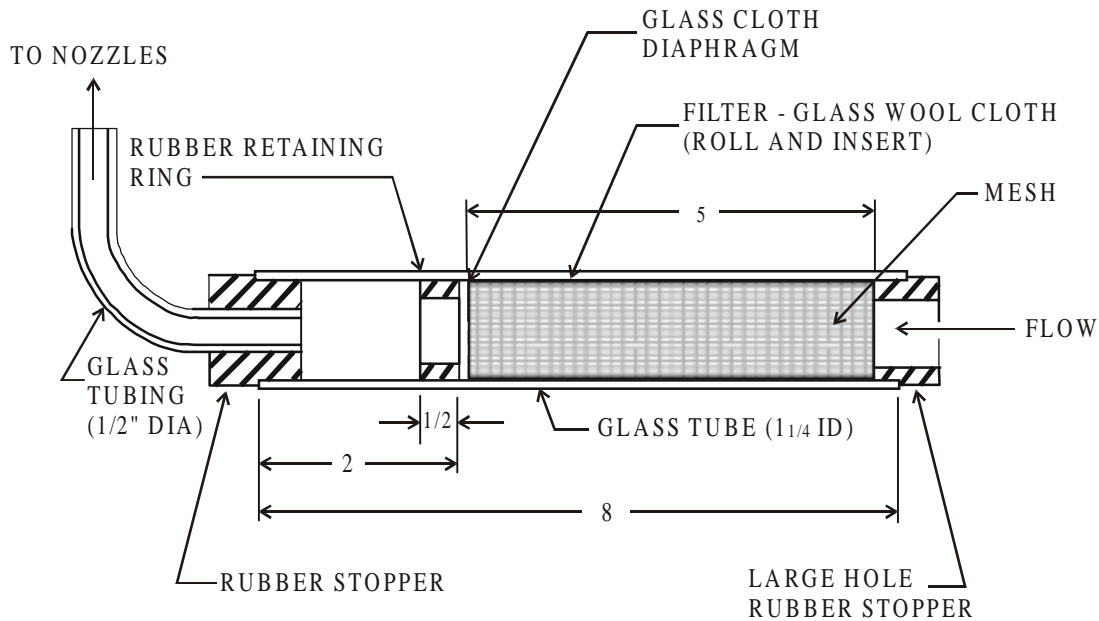

FIGURE 509.4-2. Location of salt solution filter.



DIMENSIONS (IN INCHES) ARE FOR GUIDANCE PURPOSES.

FIGURE 509.4-3. Salt solution filter.

MIL-STD-810F
1 January 2000

THIS PAGE INTENTIONALLY BLANK

METHOD 510.4

SAND AND DUST

NOTE: Tailoring is essential. Select methods, procedures, and parameter levels based on the tailoring process described in Part One, paragraph 4.2.2, and Appendix C. Apply the general guidelines for laboratory test methods described in Part One, paragraph 5 of this standard.

1. SCOPE.

1.1 Purpose.

- a. Small-particle dust ($\leq 149 \mu\text{m}$) procedures. These tests are performed to help evaluate the ability of materiel to resist the effects of dust that may obstruct openings, penetrate into cracks, crevices, bearings, and joints and to evaluate the effectiveness of filters.
- b. Blowing sand (150 to 850 μm particle size) procedures. These tests are performed to help evaluate if materiel can be stored and operated under blowing sand conditions without degrading performance, effectiveness, reliability, and maintainability due to abrasion (erosion) or clogging effects of large, sharp-edged particles.

1.2 Application.

Use this method to evaluate all mechanical, optical, electrical, electronic, electrochemical, and electromechanical devices likely to be exposed to dry, blowing sand, blowing dust-laden atmosphere, or settling dust.

1.3 Limitations.

This method is not suitable for determining erosion of airborne (in flight) materiel because of the particle impact velocities involved, or for determining the effects of a buildup of electrostatic charge. Additionally, because of control problems, this method does not address sand or dust testing out-of-doors.

2. TAILORING GUIDANCE.

2.1 Selecting the Sand and Dust Method.

After examining requirements documents and applying the tailoring process in Part One of this standard to determine where sand and dust environments are foreseen in the life cycle of the materiel, use the following to confirm the need for this method and to place it in sequence with other methods.

2.1.1 Effects of sand and dust environments.

Although the blowing sand and dust environment is usually associated with hot-dry regions, it exists seasonally in most other regions. Naturally-occurring sand and dust storms are an important factor in the deployment of materiel, but with the increased mechanization of military operations, they cause less of a problem than does sand and dust associated with man's activities. Consider the following typical problems to help determine if this method is appropriate for the materiel being tested. This list is not intended to be all-inclusive.

- a. Abrasion and erosion of surfaces.
- b. Penetration of seals.
- c. Degradation of electrical circuits.
- d. Obstruction/clogging of openings and filters.

MIL-STD-810F
1 January 2000

- e. Physical interference with mating parts.
- f. Fouling/interference of moving parts.
- g. Reduction of thermal conductivity.
- h. Interference with optical characteristics.
- i. Overheating and fire hazard due to restricted ventilation or cooling.

2.1.2 Sequence among other methods.

- a. General. See Part One, paragraph 5.5.
- b. Unique to this method. This method will produce a dust coating on, or severe abrasion of a test item, which could influence the results of other MIL-STD-810 methods such as Humidity (method 507.4), Fungus (method 508.5), and Salt Fog (method 509.4). Therefore, use judgment in determining where in the sequence of tests to apply this method. Additionally, results obtained from the High Temperature test method (501.4) may be required to define temperature parameters used in this method. On the other hand, the presence of dust in combination with other environmental parameters can induce corrosion or mold growth. A warm humid environment can cause corrosion in the presence of chemically aggressive dust.

2.2 Selecting Procedures.

This method includes three test procedures, Procedure I (Blowing Dust), Procedure II (Blowing Sand), and Procedure III (Settling Dust). Determine the procedure(s) to be used.

2.2.1 Procedure selection considerations.

When selecting procedures, consider:

- a. The operational purpose of the materiel. From the requirements documents, determine the functions to be performed by the materiel in a sand or dust environment and any limiting conditions such as storage.
- b. The natural exposure circumstances.
- c. The test data required to determine if the operational purpose of the materiel has been met.
- d. Procedure sequence. If both sand and dust procedures are to be applied to the same test item, it is generally more appropriate to conduct the less damaging first, i.e., settling dust, blowing dust, and then blowing sand.

2.2.2 Difference among procedures.

While all procedures involve sand and dust, they differ on the basis of particle size and type of movement. These test procedures are tailorable to the extent that the user must specify the test temperature, dust composition, test duration, and air velocity.

- a. Procedure I - Blowing Dust. Use Procedure I to investigate how susceptible materiel is to concentrations of blowing dust ($< 149 \mu\text{m}$).
- b. Procedure II - Blowing Sand. Use Procedure II to investigate how susceptible materiel is to the effects of blowing, large particle sand ($150 \mu\text{m}$ to $850 \mu\text{m}$).
- c. Procedure III - Settling Dust. Use Procedure III to investigate the effects of settling dust ($\leq 105 \mu\text{m}$) on materiel (usually electrical) in sheltered or enclosed areas with negligible airflow (e.g., offices, laboratories, store rooms, tents) where dust may accumulate over long periods. Settling dust can also affect the heat dissipation of materiel with accumulated dust on the top surface. Also, use the settling dust test to verify the quality of air filters used in the inlet of air pollution samplers for outdoor use.

2.3 Determine Test Levels and Conditions.

Having selected this method and relevant procedures (based on the materiel's requirements documents and the tailoring process), it is necessary to complete the tailoring process by selecting specific parameter levels and special test conditions/techniques for these procedures based on requirements documents, Life Cycle Environmental Profile, Operational Environment Documentation (see Part One, figure 1-1), and information provided with this procedure. From these sources of information, determine the functions to be performed by the materiel in sand and dust environments or following storage in such environments. Then determine the sand and dust levels of the geographical areas and micro-environments in which the materiel is designed to be employed. To do this, consider the following in light of the operational purpose and life cycle of the materiel.

2.3.1 Identify climatic conditions.

Identify the appropriate climatic conditions for the geographic areas in which the materiel will be operated and stored, and whether or not test item needs to be operated during the test.

2.3.2 Determine exposure conditions.

Base the specific test conditions on field data if available. In the absence of field data, determine the test conditions from the applicable requirements documents. If this information is not available, use the following guidance:

2.3.2.1 Test item configuration.

Use a test item configuration that reproduces, as close as possible, the anticipated materiel configuration during storage or use, such as:

- a. Enclosed in a shipping/storage container or transit case.
- b. Protected or unprotected.
- c. Deployed realistically or with restraints, such as with openings that are normally covered.

2.3.2.2 Temperature.

Unless otherwise specified, conduct the blowing sand and blowing dust tests with the test item at the high operating or storage temperature obtained from the temperature response of the test item in the high temperature test (method 501.4). Unless otherwise specified, perform the settling dust test at $23 \pm 2^\circ\text{C}$ which is in the standard ambient range.

2.3.2.3 Relative humidity.

High levels of relative humidity (RH) may cause caking of dust particles. Consequently, control the test chamber RH to not exceed 30% for both blowing and settling tests.

2.3.2.4 Air velocity.

- a. Blowing dust. The air velocities used in the blowing dust (small particle) test procedure include a minimum air velocity of 1.5 m/s (300 ft/min) to maintain test conditions, and a higher air velocity of 8.9 m/s (1750 ft/min) typical of desert winds, to be used in the absence of specified values. Use other air velocities if representative of natural conditions and if the capabilities of the test chamber allow.
- b. Blowing sand. Winds of 18 m/s (3540 ft/min) capable of blowing the large particle sand are common, while gusts up to 29 m/s (5700 ft/min) are not unusual. If the induced flow velocity around the materiel in its field application is known to be outside of this range, use the known velocity. Otherwise use an air velocity in the range of 18-29 m/s to maintain the blowing sand particles.

NOTE: Ensure the sand particles impact the test item at velocities ranging from 18-29 m/s. In order for the particles to attain these velocities, maintain an approximate distance of 3-m (10 ft) from the sand injection point to the test item. Use shorter distances if it can be proven the particles achieve the necessary velocity at impact.

MIL-STD-810F
1 January 2000

- c. Settling dust. Use only sufficient air velocity to disperse the dust in the air above the test item, and ensure it does not produce an air velocity at the test item of more than 0.2 m/s.

2.3.2.5 Sand and dust composition.

- a. Blowing dust. Conduct the small-particle (blowing dust) procedure with any of the following dust compositions, by weight.

- (1) Red china clay is common worldwide and contains:

| | |
|--|----------------------|
| CaCO ₃ , MgCO ₃ , MgO, TiO ₂ , etc. | 5% |
| Ferric oxide (Fe ₂ O ₃) | 10 ±5% |
| Aluminum oxide (Al ₂ O ₃) | 20 ±10% |
| Silicon dioxide (SiO ₂) | remaining percentage |

- (2) Silica flour has been widely used in dust testing and contains 97 to 99 percent (by weight) silicon dioxide.

- (3) Other materials may be used for dust testing, but their particle size distribution may fall below that in 2.3.2.5a(4), below. Ensure material to be used is appropriate for the intended purpose and regions of the world being simulated; e.g., for dust penetration, ensure the particle sizes are no larger than those identified for the region. These materials for dust testing include talc (talcum powder) (hydrated magnesium silicate), F.E. (fire extinguisher powder composed mainly of sodium or potassium hydrogen carbonate with a small amount of magnesium stearate bonded to the surface of the particles in order to assist free-running and prevent clogging - must be used in dry conditions to prevent corrosive reaction and formation of new chemicals (reference c.)), quartz (the main constituent of many dusts occurring in nature), and undecomposed feldspar and olivine (which have similar properties to quartz).

****WARNING**:** Refer to the supplier's Material Safety Data Sheet (MSDS) or equivalent for health hazard data. Exposure to silica flour can cause silicosis; other material may cause adverse health effects.

- (4) Unless otherwise specified, use a particle size distribution of 100% by weight less than 150 µm, with a median diameter (50% by weight) of 20 ±5 µm. This dust is readily available as a 140 mesh Silica Flour (about 2% retained on a 140 mesh (108 microns) sieve) and should provide comparable results to prior test requirements. National documentation may contain other more specific distributions.

- b. Blowing sand. Unless otherwise specified, for the large particle sand test use silica sand (at least 95% by weight SiO₂). Use sand of sub-angular structure, a mean Krumbein number range of 0.5 to 0.7 for both roundness and sphericity and a hardness factor of 7 mhos. Due to the loss of subangular structure and contamination, re-use of test sand is normally not possible. If possible, determine the particle size distribution from the geographical region in which the material will be deployed. There are 90 deserts in the world, each with different particle size distributions. Therefore, it is impossible to specify a particle size distribution that encompasses all areas. The recommended particle size distribution for the large particle sand test is from 150µm to 850 µm, with a mean of 90 ±5% by weight smaller than 600 µm and larger than 149 µm, and at least 5% by weight 600 µm and larger. When material is designed for use in a region which is known to have an unusual or special sand requirement, analyze a sample of such sand to determine the distribution of the material used in the test. Specify the details of its composition in the requirements documents.

****WARNING**:** The same health hazard considerations as noted for the dust apply. Refer to the supplier's Material Safety Data Sheet (MSDS) or equivalent for health hazard data; exposure can cause silicosis.

- c. Settling dust. Although settling dust can be of numerous compositions to include quartz, silica, salts, fertilizers, organic fibers, etc., use the small particle dusts described above to evaluate the potential effects of most settling dust. Do not use dust with particles larger than 105 µm.

2.3.2.6 Sand and dust concentrations.

- a. **Blowing dust.** Unless otherwise specified, maintain the dust concentration for the blowing dust test at $10 \pm 7 \text{ g/m}^3$ ($0.3 \pm 0.2 \text{ g/ft}^3$) unless otherwise specified. This figure is not unrealistic and is used because of the limitations of most chambers.
- b. **Blowing sand.** Unless otherwise specified, maintain the sand concentrations as follows (reference a):
 - (1) For material likely to be used close to helicopters operating over unpaved surfaces: $2.2 \pm 0.5 \text{ g/m}^3$ ($0.06 \pm 0.015 \text{ g/ft}^3$).
 - (2) For material never used or exposed in the vicinity of operating aircraft, but which may be used or stored unprotected near operating surface vehicles: $1.1 \pm 0.3 \text{ g/m}^3$ ($0.033 \pm 0.0075 \text{ g/ft}^3$).
 - (3) For material that will be subjected only to natural conditions: 0.18 g/m^3 , $-0.0/+0.2 \text{ g/m}^3$ (0.005 g/ft^3). (This large tolerance is due to the difficulties of measuring concentrations at low levels.)
- c. **Settling dust.** For the settling dust test, the relationship between severity (duration and concentration) is difficult to determine. Real conditions vary considerably, and this test is intended to standardize a means to demonstrate survival of the materiel, and not necessarily duplicate conditions. Consequently, only guidelines are given in order to provide guidance on the relationship between the severity levels of the test and some values from real conditions. Unless otherwise specified, use a dust settlement rate of $6 \text{ g/m}^2/\text{day}$. Table 510.4-I provides average dust deposits for various areas along with a rough guide to acceleration factors for the specified rates (reference d). For example, a 3-day test equates to between 51 days and 1800 days (5 years) for rural and suburban environments, and between 9 days and 18 days for an industrial environment.

TABLE 510.4-I. Settling dust quantities and acceleration factors.

| AREA | DUST SETTLEMENT PER DAY (g/m^2) | ACCELERATION FACTOR (with $6 \text{ g/m}^2/\text{day}$) |
|--------------------|---|---|
| Rural and suburban | 0.01 - 0.36 | 600 - 17 |
| Urban | 0.36 - 1.00 | 17 - 6 |
| Industrial | 1.00 - 2.00 | 6 - 3 |

2.3.2.7 Orientation.

- a. **Blowing dust tests.** Unless otherwise specified, orient the test item such that the most vulnerable surfaces face the blowing dust. Using the specified test duration, rotate the test item (if required) at equal intervals to expose all vulnerable surfaces.
- b. **Blowing sand tests.** Orient the test item with respect to the direction of the blowing sand such that the test item will experience maximum erosion effects. The test item may be re-oriented at 90-minute intervals.
- c. **Settling dust tests.** Install the test item in the test chamber in a manner representative of its anticipated deployment in service.

2.3.2.8 Duration.

- a. **Blowing dust.** Unless otherwise specified, conduct blowing dust tests for 6 hours at 23°C and an additional 6 hours at the high storage or operating temperature. If necessary, stop the test after the first 6-hour period provided that prior to starting the second 6-hour period the chamber conditions are restabilized.
- b. **Blowing sand.** Perform blowing sand tests for a minimum of 90 minutes per each vulnerable face.

MIL-STD-810F
1 January 2000

- c. Settling dust. Use a basic deposition rate of 6 g/m²/day. This, combined with the values shown in table 510.4-I provides a rough guide to acceleration factors for the areas shown. If no specific region is identified, use a test duration of three days (for standardization purposes) to provide a reasonable severity.

2.3.2.9 Operation during test.

- a. Determine the need to operate the test item during exposure to sand or dust from the anticipated in-service operational requirements. For example, operate heating/cooling test items while exposed to extreme ambient environments, but operate certain materiel, although exposed to severe environments, in an environmentally controlled shelter. If the test item must be operated during the test, specify the time and periods of operation in the test plan. Include at least one 10-minute period of continuous operation of the test item during the last hour of the test, with the test item's most vulnerable surface facing the blowing sand or dust.
- b. For the settling dust test, condition the test item which employs forced air cooling with the air cooling system operating to determine the effect of dust trapped in filters; operate heat-generating materiel with ventilation openings for convection cooling during the test; operate heat-generating materiel of closed construction intermittently in order to produce a breathing effect by thermal cycling, or to determine thermal increase due to insulative effects of accumulated dust.

3. INFORMATION REQUIRED.

3.1 Pretest.

The following information is required to conduct sand and dust tests adequately.

- a. General. Information listed in Part One, paragraphs 5.7 and 5.9, and Appendix A, Task 405 of this standard.
- b. Specific to this method.
- (1) Test temperature
 - (2) Relative humidity
 - (3) Air velocity
 - (4) Sand or dust composition
 - (5) Sand or dust concentration
 - (6) Operating requirements
 - (7) Test item orientation and exposure time per orientation
 - (8) Methods of sand and dust removal as used in service

3.2 During Test.

Collect the following information during conduct of the test:

- a. General. Information listed in Part One, paragraph 5.10, and in Appendix A, Task 406 of this standard.
- b. Specific to this method.
- (1) Periodic dust concentrations.
 - (2) Periodic relative humidity levels.

3.3 Post Test.

The following post test information is required.

- a. General. Information listed in Part One, paragraph 5.13, and in Appendix A, Task 406 of this standard.
- b. Specific to this method.
 - (1) Initial test item orientation and any orientation change during test.
 - (2) Values of the test variables for each section of the test (temperature, relative humidity, air velocity, sand/dust concentration and duration).
 - (3) Results of each visual inspection.

4. TEST PROCESS.

4.1 Test Facility.

Ground the test item and facility to avoid buildup of an electrostatic charge. Verify resistance/continuity in accordance with applicable safety requirements for the materiel. Employ a data collection system separate from the chamber controllers to measure the test volume conditions (see Part One, paragraph 5.18). Use charts that are readable to within 0.6°C (1°F) to record temperature. Except for gaseous nitrogen (GN₂), achieve dehumidification, heating and cooling of the air envelope surrounding the test item by methods that do not change the chemical composition of the air, dust, sand and water vapor within the chamber test volume air. The following information is also appropriate.

- a. Blowing dust.
 - (1) Use a test facility that consists of a chamber and accessories to control dust concentration, velocity, temperature, and humidity of dust-laden air. In order to provide adequate circulation of the dust-laden air, use a test chamber of sufficient size that no more than 50 percent of the test chamber's cross-sectional area (normal to airflow) and 30 percent of the volume of the test chamber is occupied by the test item(s). Maintain and verify the concentration of dust in circulation within the chamber with suitable instrumentation such as a calibrated smoke meter and standard light source. Introduce the dust-laden air into the test space in such a manner as to allow the air to become as close to laminar as possible, but at least in a manner that prevents excessive turbulence as the flow of dust-laden air strikes the test item.
 - (2) Use dust in this test as outlined in paragraphs 2.3.2.4 and 2.3.2.5, above.
- b. Blowing sand. Test facility design considerations.
 - (1) In order to provide adequate circulation of the sand-laden air, use a test chamber of sufficient size that no more than 50 percent of the test chamber's cross-sectional area (normal to airflow) and 30 percent of the volume of the test chamber is occupied by the test item(s).
 - (2) Control the sand feeder to emit the sand at the specified concentrations. To simulate the effects produced in the field, locate the feeder to ensure the sand is approximately uniformly suspended in the air stream when it strikes the test item.

NOTE: Uniform sand distribution is usually easier to obtain when the sand-air mixture is directed downward.

- (3) Because of the extremely abrasive characteristics of blowing sand, do not re-circulate the sand through the fan or air conditioning equipment.
- c. Settling dust.
 - (1) Experience has shown that it is best to use a test section with a horizontal area at least twice the area of the test item (see figure 510.4-1) which is large enough to maintain the uniformity of the dust

MIL-STD-810F
1 January 2000

coating on the test item. Dust uniformity is difficult to achieve with the dust injection system. Use a test section high enough to ensure that during conditioning the air velocity around the test item is near zero (i.e., less than 0.2 m/s). In order to accomplish this, experience shows that a test section height of 4-5 times the longest horizontal test item dimension is necessary.

- (2) Inject the dust (constant or hourly) into the test section above the test item (not directly into the test item) using a minimum air flow sufficient to diffuse the dust and produce a uniform dust deposit on the test item at a rate of 0.25 g/m² each hour (6 ± 1 g/m²/day), but ensure it does not exceed 0.2 m/s at the test item. Place collection receptacles in the vicinity of the test item for dust density verification (not near fan intakes). Do not disturb the settled dust during injection. Ensure the test item is centrally located on a horizontal plane, at least 150 mm from any wall or other test item (unless more is required for test item intake fans).

- (3) Because of difficulties associated with dust quantities, the following system has worked well:

NOTE: Contain the dust in a glass cylinder with a lid that has a manifold with fine holes through which the compressed air is blown. The air stream stirs the dust and the dust is guided through a tube to the dust injection system. The volume of compressed air per unit of time, the distance between the inlet holes and the top of the dust, and the time control of compressed air determine the amount of dust being injected. Roughly check the amount of dust injected into the chamber by the weight loss of the container.

4.2 Controls.

- a. For dust testing, maintain the test chamber relative humidity (RH) at 30% or less to prevent caking of dust particles. Measure the humidity and dust concentration at least once an hour to ensure conditions are within the desired range.
- b. For the blowing sand and dust tests, continuously measure the temperature during the test. Measure the humidity at least once an hour to ensure conditions are within the desired range.
- c. Verify chamber air velocity and sand concentration prior to test. Calculate the sand feed rate and verify it by measuring the sand quantity delivered over unit time using the following formula:

$$\text{Rate} = (\text{Concentration})(\text{Area})(\text{Velocity})$$

where:

Rate = mass of sand introduced into the test chamber per set time interval

Concentration = sand concentration required by the test plan

Area = cross-sectional area of the wind stream at the test item location.

Velocity = average velocity of air at the test item location

- d. For the settling dust test, maintain the air velocity in the vicinity of the test item less than 0.2 m/s to allow settling of the finer dust particles. Use collection plates in the vicinity of the test item to verify the quantity of deposited dust.

4.3 Test Interruption.

- a. General. See Part One, paragraph 5.11 of this standard.
- b. Specific to this method.
 - (1) Undertest interruption. Follow any undertest interruption by reestablishing the prescribed test conditions and continue from the point of interruption.
 - (2) Overtest interruption. Following exposure to excessive sand or dust concentrations, remove as much of the accumulation as possible (as would be done in service) and continue from the point of interruption. If abrasion is of concern, either restart the test with a new test item or reduce the exposure period by using the concentration-time equivalency (assuming the overtest concentration rate is known).

4.4 Execution.

The following steps, alone or in combination, provide the basis for collecting necessary information concerning the test item in sand and dust environments.

4.4.1 Preparation for test.

****WARNING**** The relatively dry test environment combined with the moving air, organic dust, and sand particles may cause a buildup of electrostatic energy that could affect operation of the test item. Use caution when making contact with the test item during or following testing if organic dust is used, and be aware of potential anomalies caused by electrostatic discharge during test item checkout.

4.4.1.1 Preliminary steps.

Before starting the test, review pretest information in the currently approved test plan to determine test details (e.g., procedures, item configuration, cycles, durations, parameter levels for storage/operation, etc.). (See paragraph 3.1, above.)

- a. Determine from the test plan which test procedure is required.
- b. Determine from the test plan specific test variables to be used.
- c. Operate the test chamber without the test item to confirm proper operation.
 - (1) Calibrate the sand dispensing system for the sand concentration specified in the test plan.
 - (2) Adjust the air system or test item position to obtain the specified air velocity for the test item. See paragraph 4.1c(2), above.
 - (3) For the settling dust test, verify the fallout rate over a two-hour period using a one-minute injection period each hour, followed by a 59-minute settling period.

4.4.1.2 Pretest standard ambient checkout.

All items require a pretest standard ambient checkout to provide baseline data. Conduct the pretest checkout as follows:

- Step 1. Position the test item as near the center of the test chamber as possible and from any other test item (if more than one item is being tested). For the blowing sand or dust procedures, orient the test item to expose the most critical or vulnerable parts to the sand or dust stream. For the settling dust test, position the test to represent its normal orientation during operation or storage.

NOTE: If required by the test plan, change the orientation of the test item as specified during the test.

- Step 2. Prepare the test item in its operating configuration or as specified in the test plan.
- Step 3. Ensure the test item is grounded (either through direct contact with the test chamber or with a grounding strap).
- Step 4. Stabilize the test item temperature to standard ambient conditions.
- Step 5. Conduct a complete visual examination of the test item with special attention to sealed areas and small/minute openings.
- Step 6. Document the results.
- Step 7. Conduct an operational checkout in accordance with the test plan and record results.
- Step 8. If the test item operates satisfactorily, proceed to step 1 of the test procedure. If not, resolve the problem and restart at Step 1 of pretest checkout.

4.4.2 Procedure I - Blowing dust.

****WARNING**** Silica flour (or other dusts of similar particle size) may present a health hazard. When using silica flour, ensure the chamber is functioning properly and not leaking; if a failure of containment is noted and personnel might have been exposed, obtain air samples and compare them to the current threshold limit values of the national safety and health regulations. Make chamber repairs and/or take other appropriate action before continuing use of

MIL-STD-810F
1 January 2000

the chamber. Be extremely careful during all steps where exposure of personnel to the silica dust is possible. Additionally, fine dust becomes potentially explosive when its concentration in air exceeds 20 g/m^3 .

- Step 1. With the test item in the chamber, adjust the test section temperature to standard ambient conditions and the air velocity to the required value, determined from the test plan. Adjust the test section relative humidity to less than 30% and maintain it throughout the test.
- Step 2. Adjust the dust feed control for a dust concentration of $10 \pm 7 \text{ g/m}^3$.
- Step 3. Unless otherwise specified, maintain the conditions of Steps 1 and 2 for at least 6 hours. If required, periodically reorient the test item to expose other vulnerable faces to the dust stream. SEE ABOVE WARNING NOTES in paragraphs 5.4 and 5.4.2.
- Step 4. Stop the dust feed. Reduce the test section air velocity to approximately 1.5 m/s and adjust the temperature to standard ambient conditions or as otherwise determined from the test plan.
- Step 5. Maintain the step 4 conditions for 1 hour following test temperature stabilization.
- Step 6. Adjust the air velocity to that used in Step 1 and restart the dust feed to maintain the dust concentration as in Step 2.
- Step 7. Continue the exposure for at least 6 hours or as otherwise specified. If required, operate the test item in accordance with the test plan.
- Step 8. Allow the test item to return to standard ambient conditions, and the dust to settle. SEE THE WARNING AT THE BEGINNING OF THIS PROCEDURE AND IN PARAGRAPH 4.4.1, ABOVE.
- Step 9. Remove accumulated dust from the test item by brushing, wiping or shaking, taking care to avoid introduction of additional dust or disturbing any which may have already entered the test item. Do not remove dust by either air blast or vacuum cleaning unless these methods are likely to be used in service.
- Step 10. Perform an operational check in accordance with the approved test plan, and document the results for comparison with pretest data.
- Step 11. Inspect the test item for dust penetration, giving special attention to bearings, grease seals, lubricants, filters, ventilation points, etc. Document the results.

4.4.3 Procedure II - Blowing sand.

- Step 1. Position the test item at the required distance from the sand injection point and adjust air velocity according to test plan.
- Step 2. Stabilize the test item at its high operating temperature.
- Step 3. Adjust the sand feeder to obtain the sand mass flow rate determined from the pretest calibration.
- Step 4. Maintain the conditions of Steps 1 through 3 for the duration specified in the test plan. If required, re-orient the test item at 90-minute intervals to expose all vulnerable faces to the blowing sand and repeat Steps 1-3.
- Step 5. If operation of the test item during the test is required, perform an operational test of the item during the last hour of the test and document the results. If not, proceed to Step 6.
SEE THE WARNING IN PARAGRAPH 4.4.2, ABOVE.
- Step 6. Allow the test item to return to standard ambient conditions. Remove accumulated sand from the test item by using the methods anticipated to be used in service such as brushing, wiping, shaking, etc., taking care to avoid introduction of additional sand into the test item.
- Step 7. Conduct an operational check of the test item in accordance with the approved test plan and record results for comparison with pretest data.
- Step 8. Visually inspect the test item looking for abrasion and clogging effects, and any evidence of sand penetration. Document the results.

4.4.4 Procedure III - Settling dust.

SEE THE WARNING NOTE IN PARAGRAPH 4.4.2, ABOVE.

- Step 1. With the test item and collection plates in the test chamber, adjust the test section temperature to 23°C or as otherwise specified, and the relative humidity to less than 30%. (Maintain less than 30% relative humidity throughout the test.)

- Step 2. Following stabilization of the test item temperature, introduce the required quantity of dust into the test section for 60 ± 5 seconds.
- Step 3. Allow the dust to settle for 59 minutes.
- Step 4. Verify the dust fallout rate and, if required, repeat steps 2 and 3 above for the required number of cycles as determined from paragraphs 2.3.2.6c and 4.1c(2).
- Step 5. Without unnecessarily disturbing the dust deposits, perform an operational check in accordance with the approved test plan, and document results for comparison with pretest data.
- Step 6. Inspect the test item for dust penetration, giving special attention to bearings, grease seals, lubricants, filters, ventilation points, etc. Document the results.

5. ANALYSIS OF RESULTS.

In addition to the guidance provided in Part One, paragraphs 5.14 and 5.17, the following information is provided to assist in the evaluation of the test results. Analyze any failure of a test item to meet the requirements of the materiel specifications, and consider related information such as:

5.1 Blowing and Settling Dust Tests.

Determine if:

- a. Dust has penetrated the test item in sufficient quantity to cause binding, clogging, seizure or blocking of moving parts, non-operation contacts or relays, or the formation of electrically conductive bridges with resulting shorts.
- b. Functional performance is within the specified requirements/tolerances.
- c. Protective coatings were compromised.
- d. Abrasion of the test item exceeds the specified levels.

5.2 Large-Particle Sand Test.

Determine if:

- a. Abrasion of the test item exceeds the specified requirements.
- b. The test item operates as required.
- c. Protective coatings were compromised.

6. REFERENCE/RELATED DOCUMENTS.

- a. Synopsis of Background Material for MIL-STD-210, Climatic Extremes for Military Equipment. Bedford, MA: Air Force Cambridge Research Laboratories, January 1974. DTIC number AD-780-508.
- b. Industrial Ventilation. A Manual of Recommended Practice. Committee on Industrial Ventilation, P.O. Box 16153, Lansing, MI 48901.
- c. International Electrotechnical Commission Publication 68, Test L, Dust and Sand.
- d. International Electrotechnical Commission Publication 721-2-5, Test L: Dust and Sand.

MIL-STD-810F
1 January 2000

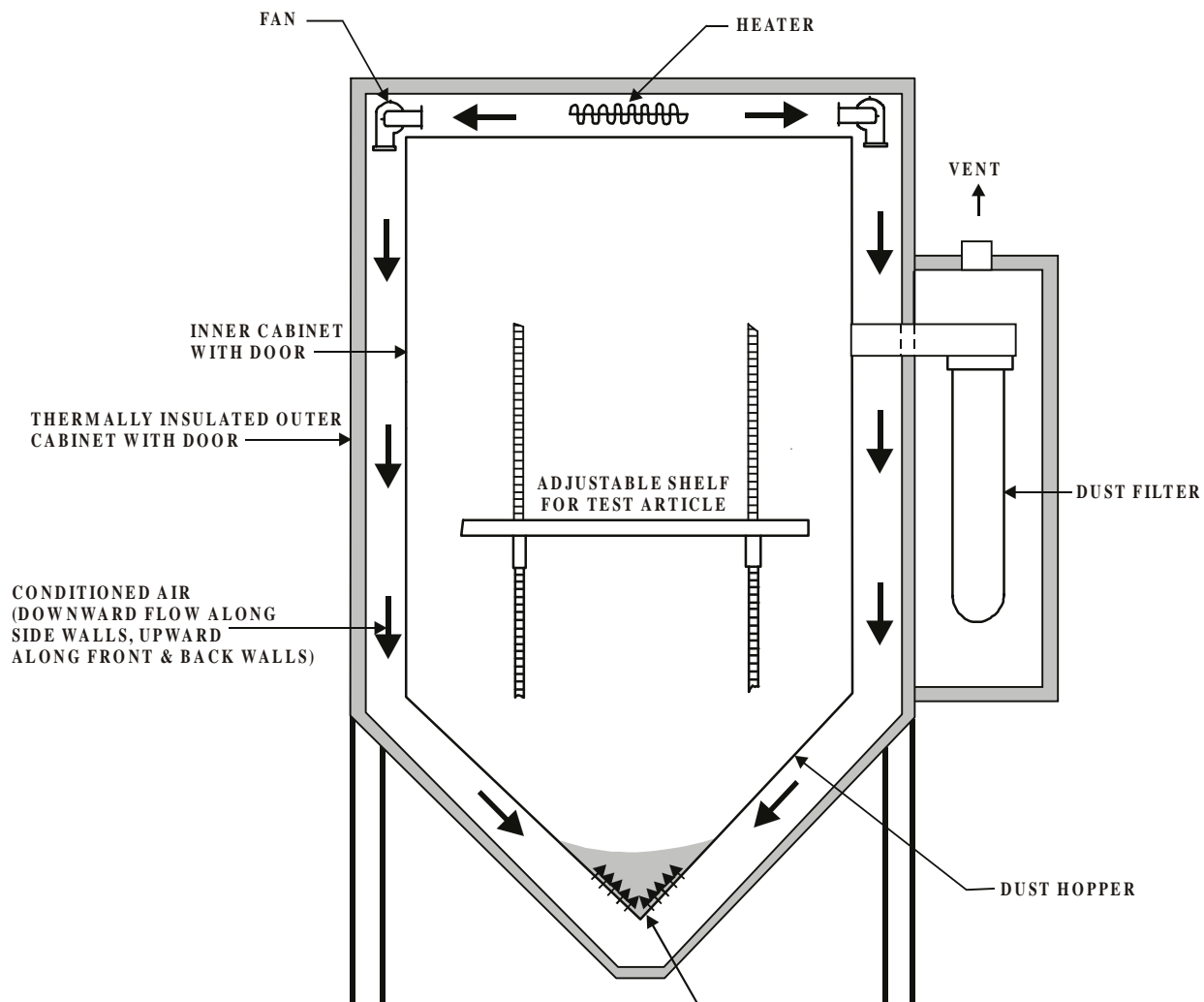

FIGURE 510.4-1. Settling dust test facility (example).

METHOD 511.4

EXPLOSIVE ATMOSPHERE

NOTE: Tailoring is essential. Select methods, procedures, and parameter levels based on the tailoring process described in Part One, paragraph 4.2.2, and Appendix C. Apply the general guidelines for laboratory test methods described in Part One, paragraph 5 of this standard.

1. SCOPE.

1.1 Purpose.

The explosive atmosphere test is performed to demonstrate the ability of materiel to operate in fuel-air explosive atmospheres without causing ignition.

1.2 Application.

This method applies to all materiel designed for use in the vicinity of fuel-air explosive atmospheres associated with aircraft, automotive, and marine fuels at or above sea level. Use other explosive atmosphere safety tests (e.g., electrical or mine safety) if more appropriate.

1.3 Limitations.

- a. This test utilizes an explosive mixture that has a relatively low flash point which may not be representative of some actual fuel-air or aerosol (such as suspended dust) mixtures.
- b. The explosive atmosphere test is a conservative test. If the test item does not ignite the test fuel-air mixture, there is a low probability that the materiel will ignite prevailing fuel vapor mixtures in service. Conversely, the ignition of the test fuel-air mixture by the test item does not mean the materiel will always ignite fuel vapors that occur in actual use.
- c. This test is not appropriate for test altitudes above approximately 16km where the lack of oxygen inhibits ignition.
- d. This method is not appropriate for determining the capability of sealed materiel to contain an explosion.

2. TAILORING GUIDANCE.

2.1 Selecting the Explosive Atmosphere Method.

After examining requirements documents and applying the tailoring process in Part One of this standard to determine where explosive atmospheres are foreseen in the life cycle of the test item, use the following to confirm the need for this method and to place it in sequence with other methods.

2.1.1 Effects of explosive atmosphere environments.

Low levels of electrical energy discharge or electrical arcing by devices as simple as pocket transistor radios can ignite mixtures of fuel vapor and air. A "hot spot" on the surface of the case of a hermetically sealed, apparently inert materiel case can ignite fuel-air mixtures. Fuel vapors in confined spaces can be ignited by a low energy discharge such as a spark from a short circuited flashlight cell, switch contacts, electrostatic discharge, etc.

2.1.2 Sequence among other methods.

- a. General. See Part One, paragraph 5.5.

MIL-STD-810F
1 January 2000

- b. Unique to this method. Considering the approach to conserve test item life by applying what are perceived to be the least damaging environments first, generally apply the explosive atmosphere test late in the test sequence. Vibration and temperature stresses may distort seals and reduce their effectiveness, thus making ignition of flammable atmospheres more likely. Recommend the test item(s) first undergo vibration and/or temperature testing.

2.2 Selecting Procedure Variations.

This method has one procedure. However, the test procedure may be varied. Before conducting this test, complete the tailoring process by selecting specific procedure variations (special test conditions/techniques for this procedure) based on requirements documents, Life Cycle Environmental Profile, Operational Environment Documentation (see Part One, figure 1-1), and information provided with this procedure. Consider the following in light of the operational purpose and life cycle of the materiel.

2.2.1 Fuel.

Unless otherwise specified, use n-hexane as the test fuel, either reagent grade or 95% n-hexane with 5% other hexane isomers. This fuel is used because its ignition properties in flammable atmospheres are equal to or more sensitive than the similar properties of both 100/130-octane aviation gasoline, JP-4 and JP-8 jet engine fuel. Optimum mixtures of n-hexane and air will ignite from hot-spot temperatures as low as 223°C, while optimum JP-4 fuel-air mixtures require a minimum temperature of 230°C for auto-ignition, and 100/130 octane aviation gasoline and air requires 441°C for hot-spot ignition. Minimum spark energy inputs for ignition of optimum fuel vapor and air mixtures are essentially the same for n-hexane and for 100/130-octane aviation gasoline. Much higher spark energy input is required to ignite JP-4 or JP-8 fuel and air mixtures. Use of fuels other than hexane is not recommended.

2.2.2 Fuel-vapor mixture.

Use a homogeneous fuel-air mixture in the correct fuel-air ratios for the explosive atmosphere test. Fuel weight calculated to total 3.8 percent by volume of the test atmosphere represents 1.8 stoichiometric equivalents of n-hexane in air, giving a mixture needing only minimum energy for ignition. This yields an air/vapor ratio (AVR) of 8.33 by weight (reference f).

- a. Required information to determine fuel weight:
- (1) Chamber air temperature during the test.
 - (2) Fuel temperature.
 - (3) Specific gravity of n-hexane (see figure 511.4-1).
 - (4) Test altitude: ambient ground or as otherwise identified.
 - (5) Net volume of the test chamber: free volume less test item displacement expressed in liters.
- b. Calculation of the volume of liquid n-hexane fuel for each test altitude:

- (1) In metric units:

Volume of 95 percent n-hexane (ml) =

$$\left(4.27 \times 10^{-4}\right) \left[\frac{(\text{net chamber vol (liters)}) \times (\text{chamber pressure (pascals)})}{(\text{chamber temp (K)}) \times (\text{specific gravity of n-hexane})} \right]$$

- (2) In English units:

Volume of 95 percent n-hexane (ml) =

$$(150.41) \left[\frac{(\text{net chamber vol (ft}^3\text{)}) \times (\text{chamber pressure (psia)})}{(\text{chamber temp (R)}) \times (\text{specific gravity of n-hexane})} \right]$$

2.2.3 Temperature.

Heat the fuel-air mixture to the highest ambient air temperature at which the materiel is required to operate during deployment and provide the greatest probability of ignition. Perform all testing at this maximum air temperature. For forced-air-cooled materiel, use a test temperature that is the highest temperature at which the materiel can be operated and performance evaluated in the absence of cooling air.

2.2.4 Effect of humidity on flammable atmosphere.

The effect of humidity upon the fuel-air composition need not be considered in the test if the ambient air dewpoint temperature is 10°C or less because this concentration of water vapor only increases the n-hexane fuel concentration from 3.82 percent to 3.85 percent of the test atmosphere. If the atmospheric pressure is cycled from an equivalent of 1525 meters above the test level to 1525 meters below, (a 34 percent change in pressure), the volume of n-hexane will decrease from 4.61 percent to 3.08 percent. This decrease will compensate for the fuel enrichment effect that results from water vapor dilution of the test air supply.

2.2.5 Altitude simulation.

The energy required to ignite a fuel-air mixture increases as pressure decreases. Ignition energy does not drop significantly for test altitudes below sea level. Therefore, unless otherwise specified, perform all tests with at least two explosive atmosphere steps, one at the highest anticipated operating altitude of the materiel (not to exceed 12,200m where the possibility of an explosion begins to dissipate) and one between 78 and 107 kPa (11.3 and 15.5 psi) which is representative of most ground ambient pressures. As noted in paragraph 1.3, because of the lack of oxygen at approximately 16 km, do not perform this test at or above this altitude.

2.3 Definitions.

For the purpose of this method, the following definitions apply:

- a. Simulated altitude. Any height that is produced in the test chamber.
- b. Test altitude. The nominal simulated height(s) above sea level at which the test item will be tested, i.e., the maximum altitude identified in paragraph 2.2.5.

3. INFORMATION REQUIRED.

3.1 Pretest.

The following information is required to conduct explosive atmosphere tests adequately.

- a. General. Information listed in Part One, paragraphs 5.7 and 5.9, and Appendix A, Task 405 of this standard.
- b. Specific to this method.
 - (1) The fuel volume and/or weight.
 - (2) The quantity of fuel required at each test point.
 - (3) The off/on cycling rate for the test item.
 - (4) Any information relative to the location of spark-emitting devices or high temperature components.

3.2 During Test.

Collect the following information during conduct of the test:

- a. General. Information listed in Part One, paragraph 5.10, and in Appendix A, Task 406 of this standard.
- b. Specific to this method.
 - (1) Periods of operation versus test altitude (on/off points).

MIL-STD-810F
1 January 2000

- (2) Quantity of fuel introduced for each test altitude.

3.3 Post-test.

- a. General. See Part One, paragraph 5.13.
- b. Specific to this method.
 - (1) Chamber test altitude and temperature for each operational check.
 - (2) Occurrence of any explosion caused by the test item.
 - (3) Initial analysis of any failures/problems.

4. TEST PROCESS.

4.1 Test Facility.

The required apparatus consists of a chamber or cabinet together with auxiliary instrumentation capable of establishing, maintaining and monitoring (see Part One, paragraph 5.18) the specified test conditions. Use a chamber with a means of igniting the fuel-air mixture such as a spark-gap device, as well as a means of determining the explosiveness of a sample of the mixture such as a spark gap or glow plug ignition source with sufficient energy to ignite a 3.82 percent hexane mixture. An alternative method of determining the explosive characteristics of the vapor is by using a calibrated explosive gas meter which verifies the degree of explosiveness and the concentration of the fuel-air mixture.

4.2 Controls.

Before each test, verify the critical parameters. Ensure spark devices function properly and the fuel atomizing system is free from deposits that could inhibit its functioning. Adjust the empty test chamber to the highest test altitude, shut off the vacuum system and measure the rate of any air leakage. Verify that any leakage is not sufficient to prevent the test from being performed as required, i.e., introduce the test fuel and wait three minutes for full vaporization, yet still be at least 1000m above the test altitude.

4.3 Test Interruption.

- a. General. See Part One, paragraph 5.11 of this standard.
- b. Specific to this method. If there is an unscheduled undertest interruption, restore the chamber air pressure to ground ambient pressure and purge the chamber to remove the flammable atmosphere. Achieve the required test altitude, inject the required volume of n-hexane and reinitiate the test using the same test item.

4.4 Test Setup.

- a. General. See Part One, paragraph 5.8.
- b. Unique to this method.
 - (1) For test item thermal stabilization measurements, install thermocouples on the most massive functional part of the test item, and two thermocouples attached to the inside the of test chamber to detect any temperature increase due to burning of the mixture.
 - (2) Install the test item in the test chamber in such a manner that it may be operated and controlled from the exterior of the chamber via sealed cable ports. Remove or loosen the external covers of the test item to facilitate the penetration of the explosive mixture. Test items requiring connection between two or more units may, because of size limitations, have to be tested independently. In this case, extend any interconnections through the cable ports.

- (3) Operate the test item to determine correct operation. If possible, identify the location of any sparking or high temperature components which could cause an explosion.
- (4) When necessary, simulate in-service mechanical loads on drive assemblies and servo-mechanical systems, and electrical loads on switches and relays; duplicate torque, voltage, current, inductive reactance, etc. In all instances, operate the test item in a manner representative of service use.

4.5 Test Execution.

The following steps, alone or in combination, provide the basis for collecting necessary information concerning the materiel in an explosive atmosphere.

4.5.1 Preparation for test.

Before starting the test, review pretest information in the test plan to determine test details (e.g., procedures, test item configuration, test temperature, test altitude, etc.).

4.5.2 Procedure I - Operation in explosive atmosphere.

- Step 1. With the test item installed, seal the chamber and stabilize the test item and chamber inner walls to within 10°C below the high operating temperature of the test item.
- Step 2. Adjust the chamber air pressure to simulate the highest operating altitude of the test item (not to exceed 12,200m) plus 2000 meters to allow for introducing, vaporizing, and mixing the fuel with the air as described in 2.2.2.
- Step 3. Slowly introduce the required volume of n-hexane into the test chamber.
- Step 4. Circulate the test atmosphere and continue to reduce the simulated chamber altitude for at least three minutes to allow for complete vaporization of fuel and the development of a homogeneous mixture.
- Step 5. At a pressure equivalent to 1000m above the test altitude, verify the potential explosiveness of the fuel-air vapor by attempting to ignite a sample of the mixture taken from the test chamber using a spark-gap device or glow plug ignition source with sufficient energy to ignite a 3.82-percent hexane mixture. If ignition does not occur, purge the chamber of the fuel vapor and repeat Steps 1-4. An alternative method of determining the explosive characteristics of the vapor is by using a calibrated explosive gas meter which verifies the degree of explosiveness and the concentration of the fuel-air mixture.
- Step 6. Operate the test item and continue operation from this step until completion of Step 7. Make and break electrical contacts as frequently and reasonably possible.
- Step 7. To ensure adequate mixing of the fuel and air, slowly decrease the simulated chamber altitude at a rate no faster than 100 meters per minute by bleeding air into the chamber.
- Step 8. Stop decreasing the altitude at 1000m below the test altitude, perform one last operational check and switch off power to the test item.
- Step 9. Verify the potential explosiveness of the air-vapor mixture as in Step 5 above. If ignition does not occur, purge the chamber of the fuel vapor, and repeat the test from Step 1.
- Step 10. Repeat steps 2-7. At site pressure, perform one last operational check and switch off power to the test item.
- Step 11. Verify the potential explosiveness of the air-vapor mixture as in Step 5 above. If ignition does not occur, purge the chamber of the fuel vapor, and repeat the test from Step 10.
- Step 12. Document the test results.

MIL-STD-810F
1 January 2000

5. ANALYSIS OF RESULTS.

In addition to the guidance provided in Part One, paragraphs 5.14 and 5.17, ignition of test fuel vapor constitutes test item failure. Apply any data relative to failure of a test item to meet the requirements of the materiel specifications to the test analysis.

6. REFERENCE/RELATED DOCUMENTS.

- a. Haskin, W.L., Explosion-Proof Testing Techniques. 1963. ASD-TDR-62-1081. DTIC number AD-400-483.
- b. Zabetakis, M.G., A.L. Furno, and G.W. Jones. "Minimum Spontaneous Ignition Temperatures of Combustibles in Air," Industrial and Engineering Chemistry 46 (1954), 2173-2178.
- c. Washburn, E.W., ed. International Critical Tables of Numerical Data. Chemistry and Technology. Vol. III. New York: National Research Council/McGraw-Hill, 1928. pp 27-29.
- d. Kuchta, J.M. Summary of Ignition Properties of Jet Fuels and Other. 1975. AFAPL-TR-75-70, pp 9-14. DTIC number AD-A021-320.
- e. ASTM E 380-79. Standard for Metric Practice.
- f. Combustion Fundamentals, Roger A. Strehlow, McGraw Hill Book Co.

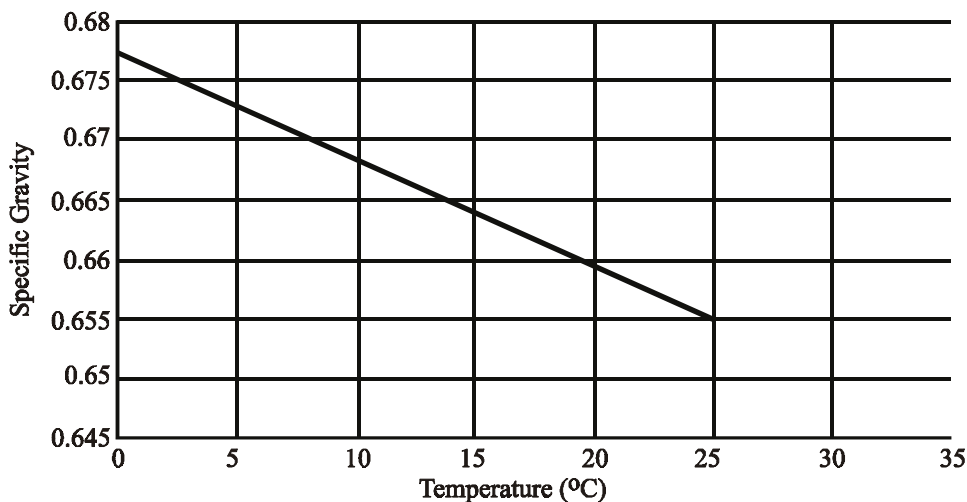

FIGURE 511.4-1. Specific gravity of n-hexane.

METHOD 512.4

IMMERSION

NOTE: Tailoring is essential. Select methods, procedures, and parameter levels based on the tailoring process described in Part One, paragraph 4.2.2, and Appendix C. Apply the general guidelines for laboratory test methods described in Part One, paragraph 5 of this standard.

1. SCOPE.

1.1 Purpose.

The immersion test is performed to determine if materiel can withstand immersion or partial immersion (e.g., fording) in water and operate as required during or following immersion.

1.2 Application.

Use this method for materiel that may be exposed to partial or complete immersion, with or without operation. This test may, in some cases, be used to verify watertightness in lieu of a rain test, provided the materiel configuration would be the same for both situations, and the method of water ingress is well understood. There are documented situations in which the impact of rain causes pumping of water across seals during the rain test that does not occur when seals are held tight against a backing plate by the static pressure of the immersion test. In most cases, both tests should be performed.

1.3 Limitations.

Immersion tests are not intended to be used for buoyant items unless the life cycle profile identifies specific applications such as restraints (including palletized loads) that could hold the materiel under water.

2. TAILORING GUIDANCE.

2.1 Selecting the Immersion Method.

After examining requirements documents and applying the tailoring process in Part One of this standard to determine where immersion or fording is anticipated in the life cycle of materiel, use the following to confirm the need for this method and to place it in sequence with other methods.

2.1.1 Effects of leakage during immersion.

Penetration of water into materiel or packaging enclosures can result in problems. Consider the following typical problems to help determine if this method is appropriate for the materiel being tested. This list is not intended to be all-inclusive.

- a. Fouling of lubricants between moving parts.
- b. Formation of electrically conductive paths which may cause electrical or electronic equipment to malfunction or become unsafe to operate.
- c. Corrosion due to direct exposure to the water or to the relatively high humidity levels caused by the water.
- d. Impairment of the burning qualities of explosives, propellants, fuels, etc.
- e. Failure of vehicle engines to operate.

MIL-STD-810F
1 January 2000

2.1.2 Sequence among other methods.

- a. General. See Part One, paragraph 5.5.
- b. Unique to this method.
 - (1) There are at least two philosophies related to test sequence. One approach is to conserve test item life by applying what are perceived to be the least damaging environments first. For this approach, generally apply the immersion test prior to most other climatic tests.
 - (2) Another approach is to apply environments to maximize the likelihood of disclosing sequential problems. For this approach, consider the immersion test both before and after structural tests such as shock and vibration to aid in determining the test item's resistance to dynamic tests.

2.2 Selecting Procedures.

This method includes two test procedures, Procedure I (Immersion) and Procedure II (Fording). Determine the procedure(s) to be used.

2.2.1 Procedure selection considerations.

When selecting procedures, consider:

- a. The operational purpose of the materiel. From the requirements documents, determine the functions to be performed by the materiel when partially or completely immersed in water.
- b. The natural exposure circumstances.
- c. The test data required to determine whether the operational purpose of the materiel has been met.

2.2.2 Difference among procedures.

While both procedures involve some degree of immersion, they differ in that Procedure I (Immersion) primarily addresses leakage during immersion of encased materiel, while Procedure II (Fording) focuses on vehicles traversing a body of water or materiel secured to such vehicles.

2.3 Determine Test Levels and Conditions.

Having selected this method and relevant procedures (based on the materiel's requirements documents and the tailoring process), it is necessary to complete the tailoring process by selecting specific parameter levels and special test conditions/techniques for these procedures based on requirements documents, Life Cycle Environmental Profile, Operational Environment Documentation (see Part One, figure 1-1), and information provided with this procedure. From these sources of information, determine the functions to be performed by the materiel while immersed or following exposure to immersion. Then, determine the depth and duration of immersion anticipated in areas in which the materiel is designed to be employed. To do this, consider the following in light of the operational purpose and life cycle of the materiel.

2.3.1 Identify climatic conditions.

Identify the appropriate climatic conditions for the geographic areas in which the materiel will be operated and stored, and whether or not test item needs to be operated during the test.

2.3.2 Determine exposure conditions.

Base the specific test conditions on field data if available. In the absence of field data, determine the test conditions from the applicable requirements documents. If this information is not available, use the following guidance:

2.3.2.1 Test item configuration.

Use a test item configuration that reproduces, as close as possible, the anticipated materiel configuration during storage or use, such as:

- a. Enclosed in a shipping/storage container or transit case.
- b. Protected or unprotected.
- c. Deployed realistically or with restraints, such as with openings that are normally covered.

2.3.2.2 Conditioning temperature.

Experience has shown that a temperature differential between the test item and the water can affect the outcome (leakage) of an immersion test. Increasing the test item temperature above the water temperature for the immersion test (Procedure I) usually includes heating of the test item to establish a pressure differential (while cooling) to determine if the seals or gaskets leak under relatively low pressure differential, and to induce expansion/contraction of materials. Although desired, establishing a specific temperature differential for fording tests is often impractical due to the size of the materiel. Also, consider materiel adjacent to heat-producing equipment such as engines, and use temperatures indicative of actual exposure.

- a. Unless otherwise identified, three options are provided for the conditioning of the test item:
 - (1) 27°C above the water temperature - to represent exposure to solar heating immediately prior to immersion.
 - (2) 10°C above the water temperature to represent a typical temperature difference between materiel and water.
 - (3) Equal to the water temperature to represent situations in which little or no temperature differential exists. This may be used for large items for which adequate conditioning facilities are not available, provided the depth of immersion is adjusted to result in the same differential pressure.
- b. Recommended the duration of conditioning immediately prior to immersion be at least two hours to ensure maximum heat loss during immersion and cooling.

2.3.2.3 Depth of immersion.

- a. Complete immersion. For testing the integrity of a test item, either use a 1m representative covering depth (measured from the uppermost surface of the test item to the surface of the water) or apply an equivalent pressure. The relevant depth/pressure equation follows:

$$P = 9.8d$$

Where:

d = depth of the water in meters

P = pressure in kPa.

NOTE: The equivalent head of sea water is 0.975 times the head of fresh water for the same pressure difference.

- b. Partial immersion. Where materiel is unlikely to be completely immersed either due to anticipated water depths or to its ability to float, and being unlikely to be restrained, a partial immersion test may be appropriate. In this case, specify depths as being measured from the base of the materiel rather than from the top as in paragraph 2.4.2.1.

2.3.2.4 Depth of fording.

The fording test may also be used to cover the requirements of STANAG 2805, "Minimum Fordability and Floatation Requirements for Tactical Vehicles and Guns, and Minimum Immersion Requirements for Combat Equipment Normally Installed or Carried in Open Vehicles or Trailers" which specifies the following depths.

MIL-STD-810F
1 January 2000

- a. Shallow fording.
 - (1) Tanks and armored cars.
 - Light tanks and armored cars - 1m.
 - Other tanks (slightly more ground compression) - 1.05m.
 - (2) Vehicles under 2 ton payload - 0.5m
 - (3) Other vehicles - 0.75m
- b. Deep fording. It is essential that all tactical vehicles and guns, either with built-in waterproofing or by the use of waterproofing kits, be able to deep ford six (6) minutes in fresh or salt water to the depths indicated below (the depth to take into account ramp angle as well as wave height):
 - (1) Fully enclosed armored vehicles should be able to deep ford to the top of the turret. (Alternatively, these vehicles to be fitted with flotation equipment.)
 - (2) All other prime movers or self propelled guns, except trailed loads, should be able to deep ford 1.5m.
 - (3) All trailers or towed guns should be capable of complete immersion. (Alternatively, this materiel should be capable of flotation.)

2.3.2.5 Materiel fording.

Materiel designed to be transported on open vehicles and trailers (such as equipment trailers) should be capable of withstanding partial immersion as anticipated during fording exercises. Examples of fording depths for this type of materiel are as follow:

- a. S-280 shelter: 53 cm
- b. S-250 shelter: 76 cm

2.3.2.6 Duration of immersion or exposure.

Use a duration of immersion typical of that anticipated during use. If this duration is unknown, a 30-minute immersion period is considered adequate to develop leakage if it is to occur. Use one hour fording durations (other than as specified in 2.3.2.2) which may be extended if justified by the anticipated life cycle profile.

3. INFORMATION REQUIRED.

3.1 Pretest.

The following information is required to conduct immersion/fording tests adequately.

- a. General. Information listed in Part One, paragraphs 5.7 and 5.9, and Appendix A, Task 405 of this standard.
- b. Specific to this method.
 - (1) The temperature to which to heat the test item (above the water temperature) and duration.
 - (2) The fording/immersion depths.
 - (3) The immersion durations.
 - (4) Tiedown precautions (to prevent unrealistic stress).

3.2 During Test.

Collect the following information during conduct of the test:

- a. General. Information listed in Part One, paragraph 5.10, and in Appendix A, Task 406 of this standard.
- b. Specific to this method.
 - (1) Location of any bubbles (indicating leaks).
 - (2) Water temperature 15 minutes following immersion.

3.3 Post Test.

The following post test information is required.

- a. General. Information listed in Part One, paragraph 5.13, and in Appendix A, Task 406 of this standard.
- b. Specific to this method.
 - (1) Pretest water and test item temperatures.
 - (2) Quantity of any free water found inside the test item and probable point(s) of entry.
 - (3) Actual covering depth of water.
 - (4) Duration of immersion.

4. TEST PROCESS.

4.1 Test Facility.

- a. For immersion tests, in addition to a chamber or cabinet capable of conditioning the test item to the required temperature, use a water container that can achieve a covering depth of 1m (or other required depth) of water over the uppermost point of the test item and maintain the test item at that depth. To represent greater depths, it may be necessary to apply air pressure to the surface of the water.
- b. For fording tests, use a facility equipped with a tie-down capability to prevent buoyant test items from floating.
- c. A water soluble dye such as fluorescein may be added to the water to aid in locating water leaks.

4.2 Controls.

Before each test, verify the critical parameters. Ensure the immersion test pulldown/hold-down device is functioning properly and that there are no safety problems.

4.3 Test Interruption.

- a. General. See Part One, paragraph 5.11 of this standard.
- b. Specific to this method.
 - (1) Undertest interruption. Treat an interruption that results in less severe conditions than specified as a "no test." Dry the test item and repeat the entire test procedure from the beginning. Treat any failure discovered during an undertest condition as a failure.
 - (2) Overtest interruption. If more severe conditions than intended are applied and a failure results, repeat the test, if possible, on a replacement item. If no failure occurs, the test need not be repeated.

4.4 Execution.

The following steps, alone or in combination, provide the basis for collecting necessary information concerning the test item when partially or completely immersed in water.

MIL-STD-810F
1 January 2000

4.4.1 Preparation for test.

4.4.1.1 Preliminary steps.

Before starting the test, review pretest information in the currently approved test plan to determine test details (e.g., procedures, item configuration, cycles, durations, parameter levels for storage/operation, etc.). (See paragraph 3.1 above.)

NOTE: Do not use sealing, taping, caulking, etc., except as required in the design specification for the materiel.

- a. If possible, when testing a shipping/storage container or transit case without the test items enclosed, remove all dunnage, packing, padding material, etc., which may absorb water before the test so that leakage can be detected. This option may not provide an adequate test of the container if the seals are not representatively stressed because of the absence of the contents.
- b. Secure items that may experience immersion when mounted on or secured to a carrying platform representatively. If representative of the real life situation, stacking is an acceptable method of restraining items under water.

4.4.1.2 Pretest standard ambient checkout.

All items require a pretest standard ambient checkout to provide baseline data. Conduct the pretest checkout as follows:

- Step 1. Stabilize the test item temperature to standard ambient conditions.
- Step 2. Conduct a complete visual examination of the test item with special attention to sealed areas, gaskets/seals, and structural integrity, and document the results. Take photographs, if appropriate. Verify that no free water is present; if so, dry.
- Step 3. Conduct an operational checkout in accordance with the test plan and record the results.
- Step 4. If the test item operates satisfactorily and seals appear to function as intended, proceed to Step 1 of the test procedure. If not, resolve the problem and restart at Step 1 of pretest checkout.

4.4.2 Procedure I - Immersion.

- Step 1. If weight gain is likely to be an acceptable method of determining leakage, weigh the test item.
- Step 2. Three times immediately before the test, open and close (or remove and replace) any doors, covers, etc., that would be opened during normal use to ensure any seals are functioning properly and are not adhering to the sealing surfaces.
- Step 3. Measure and record the immersion water temperature.
- Step 4. Condition the test item as in paragraph 2.3.2.2 and record the conditioning temperature and duration. Leave the test item's sealed areas (where appropriate) open throughout the conditioning cycle. Also, materiel occasionally incorporates valves or venting devices which may or may not be opened in normal service use. If the test item incorporates such devices, open them throughout the conditioning portion of the test.
- Step 5. Close all sealed areas and valves; assemble the test item in its test configuration and, as quickly as possible, immerse the test item in water so that the uppermost point of the test item is 1 ± 0.1 m below the surface of the water, or as otherwise required by the test plan. The orientation of the test item should represent that of its expected in-service orientation. If several orientations are possible, select that which is most severe.
- Step 6. Following a 30-minute immersion period (or as otherwise specified in the test plan), remove the test item from the water, wipe the exterior surfaces dry (giving special attention to areas around seals and relief valves) and, if applicable, equalize the air pressure inside by activating any manual valves. Be careful to not allow water to enter the test item while activating the manual valves.

- Step 7. If appropriate, re-weigh the test item.
- Step 8. Open the test item and examine the interior and contents for evidence of and quantity of any leakage, and for probable areas of entry, if leakage occurred.
- Step 9. If appropriate, conduct an operational check of the test item and record results.

4.4.3 Procedure II - Fording.

Conduct the fording test in one of two ways: by towing or driving the test item through water at the appropriate depth, or by securing the test item in a tank and flooding the tank to the required depth. Unless otherwise justified, condition the test item as in paragraph 2.3.2.2.

- Step 1. If weight gain is likely to be an acceptable method of determining leakage, weigh the test item prior to the test.
- Step 2. With the test item in its fording configuration, ensure that any drain plugs or apparatus are closed, and either:
 - a. tow or drive the test item into the water at the required depth or,
 - b. secure the test item in a watertight tank.
- Step 3. If using the tank method, flood the tank to the required height above the bottom of the test item.
- Step 4. Maintain the test item in the water for a duration as determined in paragraph 2.3.2.6.
- Step 5. Either remove the test item from the water or drain the water from the facility, and inspect the interior of the test item for evidence of free water.
- Step 6. Measure and record the amount of any free water, and the probable point(s) of entry. If appropriate, re-weigh the test item.

5. ANALYSIS OF RESULTS.

In addition to that specified in Part One, paragraphs 5.14 and 5.17, any evidence of water penetration into the test item following this test must be assessed for its short and long term effects, as well as the requirements of the test item specification. To assist in the evaluation of test results, consider the effects of free water as well as the increase of relative humidity in closed containers following the evaporation of any free water.

6. REFERENCE/RELATED DOCUMENTS.

STANAG 2805, "Minimum Fordability and Floatation Requirements for Tactical Vehicles and Guns, and Minimum Immersion Requirements for Combat Equipment Normally Installed or Carried in Open Vehicles or Trailers for Mobile Equipment."

MIL-STD-810F
1 January 2000

THIS PAGE INTENTIONALLY BLANK

METHOD 513.5

ACCELERATION

NOTE: Tailoring is essential. Select methods, procedures and parameter levels based on the tailoring process described in Part One, paragraph 4, and Appendix C. Apply the general guidelines for laboratory test methods described in Part One, paragraph 5 of this standard.

1. SCOPE.

1.1 Purpose.

The acceleration test is performed to assure that materiel can structurally withstand the steady state inertia loads that are induced by platform acceleration, deceleration, and maneuver in the service environment, and function without degradation during and following exposure to these forces. Acceleration tests are also used to assure that materiel does not become hazardous after exposure to crash inertia loads.

1.2 Application.

This test method is applicable to materiel that is installed in aircraft, helicopters, manned aerospace vehicles, air-carried stores, and ground-launched missiles.

1.3 Limitations.

1.3.1 Acceleration.

As addressed in this method, acceleration is a load factor (inertia load, "g" load) applied slowly enough and held steady for a period of time long enough such that the materiel has sufficient time to fully distribute the resulting internal loads, and such that dynamic (resonant) response of the materiel is not excited. Where loads do not meet this definition, more sophisticated analysis, design, and test methods are required.

1.3.2 Aerodynamic loads.

Materiel mounted such that any or all surfaces are exposed to aerodynamic flow during platform operations are subject to aerodynamic loads in addition to inertia loads. This method is not generally applicable to these cases. Materiel subject to aerodynamic loads must be designed and tested to the worst case combinations of these loads. This often requires more sophisticated test methods usually associated with airframe structural (static and fatigue) tests.

1.3.3 Acceleration versus shock.

Acceleration loads are expressed in terms of load factors which, although dimensionless, are usually labeled as "g" loads. Shock environments (methods 516.5 and 517) are also expressed in "g" terms. This sometimes leads to the mistaken assumption that acceleration requirements can be satisfied by shock tests or vice versa. Shock is a rapid motion that excites dynamic (resonant) response of the materiel but with very little overall deflection (stress). Shock test criteria and test methods cannot be substituted for acceleration criteria and test methods or vice versa.

MIL-STD-810F
1 January 2000

2. TAILORING GUIDANCE.

2.1 Selecting the Acceleration Method.

After examining requirements documents and applying the tailoring process in Part One of this standard to determine where acceleration effects are foreseen in the life cycle of the materiel, use the following to confirm the need for this method and to place it in sequence with other methods.

2.1.1 Effects of acceleration.

Acceleration results in loads on mounting hardware and internal loads within materiel. Note that all elements of the materiel are loaded, including fluids. The following is a partial list of detrimental effects from high levels of acceleration. Expectation that any of these may occur will confirm the need to test for this occurrence.

- a. Structural deflections that interfere with materiel operation.
- b. Permanent deformation and fractures that disable or destroy materiel.
- c. Broken fasteners and supports that result in loose parts within materiel.
- d. Broken mounting hardware that results in loose materiel within a platform.
- e. Electronic circuit boards that short out and circuits that open up.
- f. Inductances and capacitances that change value.
- g. Relays that open or close.
- h. Actuators and other mechanisms that bind.
- i. Seals that leak.
- j. Pressure and flow regulators that change value.
- k. Pumps that cavitate.
- l. Spools in servo valves that are displaced causing erratic and dangerous control system response.

2.1.2 Sequence among other methods.

- a. General. See Part One, paragraph 5.5.
- b. Unique to this method. Conduct the high temperature test (method 501.4) prior to acceleration.

2.2 Selecting a Procedure.

This method includes three test procedures.

- a. Procedure I – Structural Test.
- b. Procedure II – Operational Test.
- c. Procedure III – Crash Safety Test.

2.2.1 Procedure selection considerations.

Subject materiel to be tested to both Procedure I and Procedure II tests unless otherwise specified. Subject manned aircraft materiel that is located in occupied areas or in ingress and egress routes to Procedure III.

2.2.2 Difference among procedures.**2.2.1.1 Procedure I - Structural Test.**

Procedure I is used to demonstrate that materiel will structurally withstand the loads induced by in-service accelerations.

2.2.1.2 Procedure II - Operational Test.

Procedure II is used to demonstrate that materiel will operate without degradation during and after being subjected to loads induced by in-service acceleration.

2.2.1.3 Procedure III – Crash Safety Test.

Procedure III is used to demonstrate that materiel will not disintegrate or be torn loose from its mounts by crash accelerations.

2.3 Determine Test Levels and Conditions.

The tests vary in acceleration level, axis of acceleration, duration, test apparatus, and on/off state of test item. Obtain acceleration values for individual materiel items from the platform structural loads analyses. When the applicable platform is unknown, the values of tables 513.5-I, 513.5-II, and 513.5-III and the following paragraphs may be used as preliminary test criteria pending definition of actual installation criteria.

2.3.1 Test axes.

For the purpose of these tests, the direction of forward acceleration is always considered to be the direction of forward acceleration of the platform. The test item is tested in each direction along three mutually perpendicular axes for each test procedure. One axis is aligned with the forward acceleration of the platform (fore and aft, X), one axis is aligned with the spanwise direction of the platform (lateral, Y), and the third axis is perpendicular to the plane of the other two axes (up and down, Z). Figure 513.5-1 shows the three linear and three rotation axes as typically defined for vehicle acceleration.

2.3.2 Test levels and conditions - general.

Tables 513.5-I, 513.5-II, and 513.5-III list test levels for Procedure I (Structural Test), Procedure II (Operational Test), and Procedure III (Crash Safety Test), respectively. When the orientation of the materiel item relative to the operational platform is unknown, the highest pertinent level listed in a table applies to all test axes.

2.3.3 Test levels and conditions - fighter and attack aircraft.

The test levels as determined from tables 513.5-I and 513.5-II are based on accelerations at the center of gravity (CG) of the platform. For fighter and attack aircraft, the test levels, must be increased for materiel that is located away from the vehicle CG to account for loads induced by roll, pitch, and yaw during maneuvers. When criteria are developed for specific aircraft, maneuver cases are considered and the resulting additional angular accelerations may add or subtract effects from the linear acceleration effects. When the following relationships (a-f) are used, it must be assumed that the load factors always add. Thus absolute values are used in the equations. Add the load factors derived below to the Operational Test (Procedure II) levels of table 513.5-II. Multiply the load factors derived below by 1.5 and add to the Structural Test (Procedure I) levels of table 513.5-I. Do not add these values to the Crash Safety Test (Procedure III) levels of table 513.5-III.

- a. Roll maneuver, up and down test direction. The additional load factor (ΔN_z) induced by roll, is computed as follows:

$$\Delta N_z = (z/g) (d\phi/dt)^2 + (y/g) d^2\phi/dt^2$$

MIL-STD-810F
1 January 2000

- b. Roll maneuver, lateral left and lateral right directions. The additional load factor (ΔN_Y) induced by roll, is computed as follows:

$$\Delta N_Y = (y/g) (d \phi/d t)^2 + (z/g) d^2 \phi/d t^2$$

- c. Pitch maneuver, up and down test directions. The additional load factor (ΔN_Z) induced by pitch change, is computed as follows:

$$\Delta N_Z = (z/g) (d \theta/d t)^2 + (x/g) d^2 \theta/d t^2$$

- d. Pitch maneuver, fore and aft test directions. The additional load factor (ΔN_X) induced by pitch change, is computed as follows:

$$\Delta N_X = (x/g) (d \theta/d t)^2 + (z/g) d^2 \theta/d t^2$$

- e. Yaw maneuver, lateral left and right test directions. The additional load factor (ΔN_Y) induced by yaw, is computed as follows:

$$\Delta N_Y = (y/g) (d \psi/d t)^2 + (x/g) d^2 \psi/d t^2$$

- f. Yaw maneuver, fore and aft test directions. The additional load factor (ΔN_X) induced by yaw change, is computed as follows:

$$\Delta N_X = (x/g) (d \psi/d t)^2 + (y/g) d^2 \psi/d t^2$$

Where:

x = fore and aft distance of materiel from the aircraft CG, m (in)

y = lateral distance of materiel from the aircraft CG, m (in)

z = vertical distance of materiel from the aircraft CG, m (in)

g = acceleration of gravity, 9.81 m/sec² (386 in/sec²)

ϕ = angle of rotation about the X axis (roll), rad

$d \phi/d t$ = maximum roll velocity in rad/sec (if unknown use 5 rad/sec)

$d^2 \phi/d t^2$ = maximum roll acceleration in rad/sec² (if unknown use 20 rad/sec²)

θ = angle of rotation about the Y axis (pitch), rad

$d \theta/d t$ = maximum pitch velocity in rad/sec (if unknown use 2.5 rad/sec)

$d^2 \theta/d t^2$ = maximum pitch acceleration in rad/sec² (if unknown use 5 rad/sec²)

ψ = angle of rotation about the Z axis (yaw), rad

$d \psi/d t$ = maximum yaw velocity in rad/sec (if unknown use 4 rad/sec)

$d^2 \psi/d t^2$ = maximum yaw acceleration in rad/sec² (if unknown use 3 rad/sec²)

2.4 Special Considerations.

- a. Sway space measurements. If a piece of materiel is mounted on vibration isolators or shock mounts, perform the tests with the materiel mounted on the isolators/mounts. Measure the deflections of the isolators/mounts while the test item is exposed to the test accelerations. These data are needed to indicate potential interference with adjacent materiel, (i.e., define sway space requirements).
- b. Acceleration simulation. Careful assessment of the function and characteristics of the test item has to be made in selecting the apparatus on which the acceleration tests are to be performed due to the differences in the manner in which acceleration loads are produced. There are two types of apparatus that are commonly used: the centrifuge and a track/rocket-powered-sled combination.
- c. Centrifuge. The centrifuge generates acceleration loads by rotation about a fixed axis. The direction of acceleration is always radially toward the center of rotation of the centrifuge, whereas the direction of the load induced by acceleration is always radially away from the axis of rotation. When mounted directly on the test arm, the test item experiences both rotational and translational motion. The direction of the acceleration and the load induced is constant with respect to the test item for a given rotational speed, but

the test item rotates 360 degrees for each revolution of the arm. Certain centrifuges have counter-rotating fixtures mounted on the test arm to correct for rotation of the test item. With this arrangement, the test item maintains a fixed direction with respect to space, but the direction of the acceleration and the induced load rotates 360 degrees around the test item for each revolution of the arm. Another characteristic is that the acceleration and induced load are in direct proportion to the distance from the center of rotation. This necessitates the selection of a centrifuge of adequate size so that the portions of the test item nearest to and furthest from the center of rotation are subjected to not less than 90 percent or more than 110 percent, respectively, of the specified test level.

- d. Track/rocket-powered-sled. The track/rocket-powered sled test arrangement generates linear acceleration in the direction of the sled acceleration. The test item mounted on the sled is uniformly subjected to the same acceleration level that the sled experiences. The acceleration test level and the time duration at the test level is dependent upon the length of the track, the power of the rocket, and the rocket charge. The sled track generally will produce a significant vibration environment due to track roughness. Typically this vibration is significantly more severe than the normal in-service use environment. Careful attention to the attachment design may be needed to isolate the test item from this vibration environment. In performing Procedure II tests, the support equipment necessary to operate the test item is mounted on the sled and traverses the track with the test item. This requires the use of self-contained power units and a remote control system to operate the test item while traversing the track. Telemetry or ruggedized instrumentation is required to measure the performance of the test item while it is exposed to the test load.

MIL-STD-810F
1 January 2000

TABLE 513.5-I. Suggested g levels for Procedure I - Structural Test.

| Vehicle Category ^{1/} | | Forward Acceleration A (g's) ^{2/} | Test Level | | | | | |
|---------------------------------------|------------------|---|--|------|------------------------|------------------------|------------------------|------------------------|
| | | | Direction of Vehicle Acceleration (See figure 513.5-1) | | | | | |
| | | | Fore | Aft | Up | Down | Lateral | |
| Left | Right | | | | | | | |
| Aircraft ^{3/, 4/} | | 2.0 | 1.5A | 4.5A | 6.75A | 2.25A | 3.0A | 3.0A |
| Helicopters | | ^{5/} | 4.0 | 4.0 | 10.5 | 4.5 | 6.0 | 6.0 |
| Manned Aerospace Vehicles | | 6.0 to 12.0 ^{6/} | 1.5A | 0.5A | 2.25A | 0.75A | 1.0A | 1.0A |
| Aircraft Stores Carried on: | Wing/ Sponson | 2.0 | 7.5A | 7.5A | 9.0A | 4.9A | 5.6A | 5.6A |
| | Wing Tip | 2.0 | 7.5A | 7.5A | 11.6A | 6.75A | 6.75A | 6.75A |
| | Fuselage | 2.0 | 5.25A | 6.0A | 6.75A | 4.1A | 2.25A | 2.25A |
| Ground-Launched Missiles | | ^{7/, 8/} | 1.2A | 0.5A | 1.2A' ^{9/} | 1.2A' ^{9/} | 1.2A' ^{9/} | 1.2A' ^{9/} |

^{1/} Use levels specified for individual platforms and locations on/in the platforms. Use the values of this table only if platform criteria are unavailable.

^{2/} Use levels in this column when forward acceleration is unknown. When the forward acceleration of the vehicle is known, use that value for A.

^{3/} For carrier-based aircraft, use 4 as a minimum value for A, representing a basic condition associated with catapult launches.

^{4/} For attack and fighter aircraft, add pitch, yaw and roll accelerations as applicable (see paragraph 2.3.3).

^{5/} For helicopters, forward acceleration is unrelated to acceleration in other directions. Test levels are based on current and near future helicopter design requirements.

^{6/} When forward acceleration is not known, use the high value of the acceleration range.

^{7/} A is derived from the propulsion thrust curve data for maximum firing temperature.

^{8/} In some cases, the maximum maneuver acceleration and the maximum longitudinal acceleration will occur at the same time. When this occurs, test the materiel with the appropriate factors using the orientation and levels for the maximum (vertical) acceleration.

^{9/} Where A' is the maximum maneuver acceleration.

TABLE 513.5-II. Suggested g levels for Procedure II - Operational Test.

| Vehicle Category <u>1/</u> | | Forward Acceleration A (g's) <u>2/</u> | Test Level | | | | | |
|-----------------------------------|------------------|---|--|-------|--------------------|--------------------|--------------------|--------------------|
| | | | Direction of Vehicle Acceleration (See figure 513.5-1) | | | | | |
| | | | Fore | Aft | Up | Down | Lateral | |
| Left | Right | | | | | | | |
| Aircraft <u>3/, 4/</u> | | 2.0 | 1.0A | 3.0A | 4.5A | 1.5A | 2.0A | 2.0A |
| Helicopters | | <u>5/</u> | 2.0 | 2.0 | 7.0 | 3.0 | 4.0 | 4.0 |
| Manned Aerospace Vehicles | | 6.0 to 12.0 <u>6/</u> | 1.0A | 0.33A | 1.5A | 0.5A | 0.66A | 0.66A |
| Aircraft Stores Carried on: | Wing/ Sponson | 2.0 | 5.0A | 5.0A | 6.0A | 3.25A | 3.75A | 3.75A |
| | Wing Tip | 2.0 | 5.0A | 5.0A | 7.75A | 4.5A | 4.5A | 4.5A |
| | Fuselage | 2.0 | 3.5A | 4.0A | 4.5A | 2.7A | 1.5A | 1.5A |
| Ground-Launched Missiles | | <u>7/, 8/</u> | 1.1A | 0.33A | 1.1A' <u>9/</u> | 1.1A' <u>9/</u> | 1.1A' <u>9/</u> | 1.1A' <u>9/</u> |

1/ Use levels specified for individual platforms and locations on/in the platforms. Use the values of this table only if platform criteria are unavailable.

2/ Use levels in this column when forward acceleration is unknown. When the forward acceleration of the vehicle is known, use that value for A.

3/ For carrier-based aircraft, use 4 as a minimum value for A, representing a basic condition associated with catapult launches.

4/ For attack and fighter aircraft, add pitch, yaw and roll accelerations as applicable (see paragraph 2.3.3).

5/ For helicopters, forward acceleration is unrelated to acceleration in other directions. Test levels are based on current and near future helicopter design requirements.

6/ When forward acceleration is not known, use the high value of the acceleration range.

7/ A is derived from the propulsion thrust curve data for maximum firing temperature.

8/ In some cases, the maximum maneuver acceleration and the maximum longitudinal acceleration will occur at the same time. When this occurs, test the materiel with the appropriate factors using the orientation and levels for the maximum (vertical) acceleration.

9/ Where A' is the maximum maneuver acceleration.

MIL-STD-810F
1 January 2000

TABLE 513.5-III. Suggested g levels for Procedure III - Crash Safety Test.³

| Vehicle/Category | Test Level ^{1/} | | | | | |
|---|--|-----|-----|------|------|-------|
| | Direction of Vehicle Acceleration (See figure 513.5-1) | | | | | |
| | Fore | Aft | Up | Down | Left | Right |
| All manned aircraft except cargo/transport | | | | | | |
| Personnel capsule | 40 | 12 | 10 | 25 | 14 | 14 |
| Ejection seat | 40 | 7 | 10 | 25 | 14 | 14 |
| All other items ^{2/} | 40 | 20 | 10 | 20 | 14 | 14 |
| Cargo/transport | | | | | | |
| Pilot and aircrew seats | 16 | 6 | 7.5 | 16 | 5.5 | 5.5 |
| Passenger seats | 16 | 3 | 4 | 16 | 5.5 | 5.5 |
| Side facing troop seats | 3 | 3 | 5 | 16 | 3 | 3 |
| Personnel restraint | 10 | 5 | 5 | 10 | 3 | 3 |
| Stowable troop seats | 10 | 5 | 5 | 10 | 10 | 10 |
| All other items ^{2/} | 20 | 10 | 10 | 20 | 10 | 10 |

^{1/} Use levels specified for individual platforms and locations on/in the platforms. Use the values of this table only if platform criteria are unavailable.

^{2/} The intent of this test is to disclose structural failures of materiel that may present a hazard to personnel during or after a crash. This test is intended to verify that materiel mounting and/or restraining devices will not fail and that sub-elements are not ejected during a crash. Use for materiel mounted in flight occupied areas and/or which could block aircrew/passenger egress or rescue personnel ingress after a crash.

^{3/} Test item function is not required following this test. Thus test items that are not suitable for other tests or field use may be used for this test. Test items should be structurally representative (strength, stiffness, mass, and inertia) of the production design but need not be functional. All contents (including fluids) designed to be carried in/on the materiel should be included.

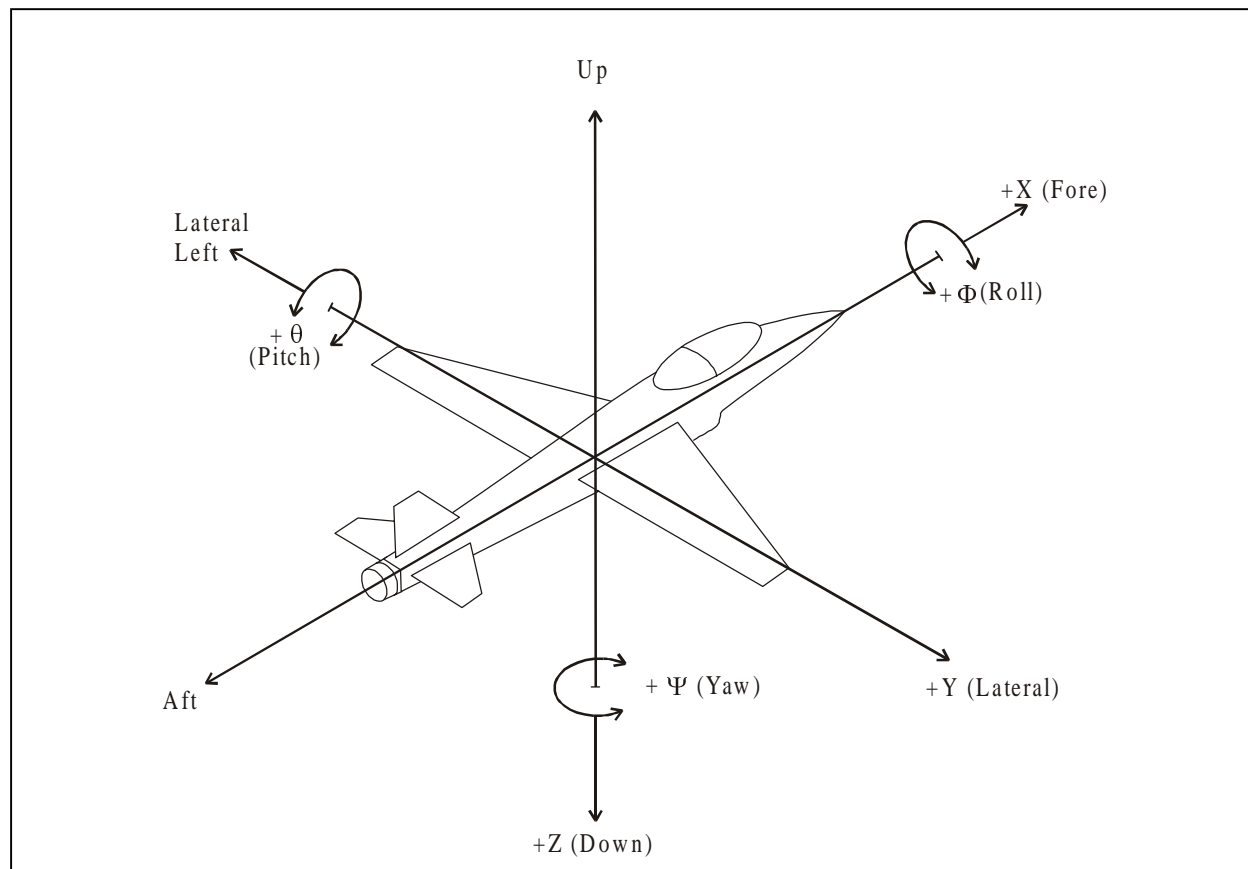

FIGURE 513.5-1. Directions of vehicle acceleration.

3. INFORMATION REQUIRED.

3.1 Pretest.

The following information is required to conduct acceleration tests adequately.

- a. General. Information listed in Part One, paragraphs 5.7 and 5.9, and Part One, Appendix A, Tasks 405 and 406 of this standard.
- b. Specific to this test method.
 - (1) Vector orientation of test item with respect to the fixture.
 - (2) Vector orientation of fixture with respect to direction of acceleration.

3.2 During Test.

Collect the following information during conduct of the test:

- a. General. Information listed in Part One, paragraph 5.10 and in Part One, Appendix A, Tasks 405 and 406 of this standard.
- b. Specific to this Method. Information related to failure criteria for test materiel under acceleration for the selected procedure or procedures. Pay close attention to any test item instrumentation and the manner in

MIL-STD-810F
1 January 2000

which the information is received from the sensors. For example, the acquisition of sensor signals from a test item on a centrifuge must consider either the way of bringing the sensor signals out through the centrifuge, a way of telemetering the sensor signals, or the effects of the acceleration on a recorder mounted on the centrifuge near the sensor for obtaining the sensor signals.

3.3 Post-test.

- a. General. Information listed in Part One, paragraph 5.13 and in Part One, Appendix A, Tasks 405 and 406 of this standard.
- b. Specific to this method.
 - (1) Vector orientation of test item with respect to the fixture.
 - (2) Vector orientation of fixture with respect to direction of acceleration.

4. TEST PROCESS.

4.1 Test Facility.

The required apparatus consists of either a centrifuge of adequate size or a track/rocket-powered-sled test arrangement. Recommend a centrifuge for all Procedure I (Structural Test), Procedure III (Crash Safety Test), and most of Procedure II (Operational Test) evaluations. Use a track/rocket-powered-sled test arrangement for Procedure II evaluations when strictly linear accelerations are required. In general, acceleration tests will not be instrumented. If there is need for test apparatus or test fixture/test item instrumentation, follow practices and procedures outlined in reference b. Verification of the correct input acceleration to the test item will be according to procedures established at the test facility.

4.2 Controls.

4.2.1 Calibration. Ensure any acceleration measurement for test verification have been made by instrumentation properly calibrated to the amplitude and frequency ranges of measurement.

4.2.2 Tolerances. Maintain the acceleration level between 90 per cent and 110 percent of the specified level over the full dimensions of the test item.

4.3 Test Interruption.

- a. General. See Part One, paragraph 5.11, of this standard.
- b. Specific to this method.
 - (1) If an unscheduled interruption occurs while the test item is at a specified test level, restart and run the complete test. If interruptions result in several new starts, evaluate the test item for fatigue damage. (Each application of acceleration is a single loading cycle. Duration of a loading cycle does not influence the severity of the test.)
 - (2) If the test item is subjected to acceleration loads in excess of the level specified for the test, stop the test, inspect the test item and perform a functional test. Based on the inspection and functional test, make an engineering decision as to whether to resume testing with the same test item or with a new test item.

4.4 Test Execution.

4.4.1 Preparation for test.

4.4.1.1 Inspections.

All items require a pretest standard ambient checkout to provide baseline data and additional inspections and performance checks during and after tests. Conduct inspections as follows:

- Step 1. Examine the test item for physical defects, etc.
- Step 2. Prepare the test item for test, in its operating configuration if required, as specified in the test plan.
- Step 3. Obtain sufficient dimensional measurements of the test item to provide a reference guide for the evaluation of physical damage that may be induced during the tests.
- Step 4. Examine the test item/fixture/centrifuge/sled combination for compliance with the test item and test plan requirements.
- Step 5. If applicable, conduct an operational checkout in accordance with the test plan and document the results.
- Step 6. Document the results.

4.4.1.2 Mounting of the test item.

Configure the test item for service application. Mount the test item on the test apparatus using the hardware that is normally used to mount the materiel in its service installation.

a. Centrifuge mounting.

- Step 1. Determine the location for the test item by measurement from the center of rotation of the centrifuge to the location on the centrifuge arm that will provide the g level established for the test. Mount the test item so that its geometric center is at the location on the arm determined for the test load factor (g level). Calculate test levels as follows:

$$N_T = K r n^2$$

Where: N_T = test load factor (load factor normal to the centrifuge plane of rotation)

K = 1.118×10^{-3} , r in meters ($K = 2.480 \times 10^{-5}$, r in inches)

r = radial distance in meters, (inches) from the center of rotation to the mounting location on centrifuge arm

n = angular velocity of centrifuge arm in revolutions per minute (rpm)

- Step 2. Orient the test item on the centrifuge for the six test direction conventions as follows:

- (a) Fore. Front or forward end of test item facing toward center of centrifuge.
- (b) Aft. Reverse the test item 180 degrees from fore position.
- (c) Up. Top of test item facing toward center of centrifuge.
- (d) Down. Reverse item 180 degrees from up position.
- (e) Lateral left. Left side of test item facing toward center of centrifuge.
- (f) Lateral right. Right side of test item facing toward center of centrifuge.

- Step 3. After the test item is properly oriented and mounted on the centrifuge, make measurements and calculations to ensure the end of the test item nearest to the center of the centrifuge will be subjected to no less than 90 percent of the g level established for the test. If the g level is found to be less than 90 percent of the established g level, either mount the test item further out on the centrifuge arm and adjust the rotational speed accordingly, or use a larger centrifuge to ensure the end of the test item nearest to the center of the centrifuge is subjected to at least 90 percent of the established g level. However, do not subject the opposite end of the test item (the end farthest from the center of the centrifuge) to over 110 percent of the established g level. For large test items, consider exceptions

MIL-STD-810F
1 January 2000

for load gradients based on the existing availability of large centrifuges in commercial or government test facilities.

- b. Track/rocket-powered-sled mounting. For track/rocket-powered-sled mounting, mount the test item and associated test fixture or apparatus on the sled platform in accordance with the controlled acceleration direction of the sled. (Ensure the test fixture or apparatus has been designed to isolate sled vibrations from the test item.) Since the sled and test item experience the same g levels, only the orientation of the test item on the sled is critical. Orient the test item on the sled according to the acceleration directions shown on figure 513.5-1 and the controlled acceleration direction of the sled for the six test directions.

4.4.2 Procedure I - Structural Test.

- Step 1. Install the test item and place it in its operational mode and orientation as in paragraph 4.4.1.2.
- Step 2. Bring the centrifuge to the speed required to induce the specified g level in the test item as determined from paragraph 2.3 and table 513.5-I for the particular test item orientation. Maintain this g level for at least one minute after the centrifuge rpm has stabilized.
- Step 3. Functionally test and inspect the test item as specified in paragraph 4.4.1.1.
- Step 4. Repeat this test procedure for the remaining five test directions noted in paragraph 4.4.1.2.a, Step 2.
- Step 5. Upon completing the tests in the six test directions, functionally test and inspect the test item as specified in paragraph 4.4.1.1.

4.4.3 Procedure II - Operational Test.

4.4.3.1 Centrifuge.

- Step 1. Install the test item and place it in its operational mode and orientation as in paragraph 4.4.1.2.
- Step 2. Functionally test and inspect the test item as specified in paragraph 4.4.1.1.
- Step 3. With the test item operating, bring the centrifuge to the speed required to induce specified g level in the test item as determined from paragraph 2.3 and table 513.5-II for the particular test item orientation. Maintain this g level for at least one minute after the centrifuge rpm has stabilized. Conduct a performance check and document the results.
- Step 4. Stop the centrifuge and inspect the test item as specified in paragraph 4.4.1.1.
- Step 5. Repeat Steps 1-3 for the five remaining orientations noted in paragraph 4.4.1.2.a, Step 2.
- Step 6. Upon completing the tests in the six test directions, functionally check and inspect the test item according to paragraph 4.4.1.1.

4.4.3.2 Track/rocket-powered-sled.

- Step 1. Install the test item and place it in its operational mode and orientation as in paragraph 4.4.1.2.
- Step 2. Functionally test and inspect the test item as specified in paragraph 4.4.1.1.
- Step 3. With the test item operating, accelerate the sled to the level required to induce the specified g level in the test item as determined from paragraph 2.3 and table 513.5-II for the particular test item orientation. Conduct a performance check while the test item is subjected to the specified g level. Document the results.
- Step 4. Evaluate test run parameters and determine if the required test accelerations were achieved. Repeat the test run as necessary to demonstrate acceptable performance of the test item while under required test acceleration. Document test run parameters.
- Step 5. Repeat this test procedure for the five remaining test directions noted in paragraph 4.4.1.2.a, Step 2. Upon completing the tests in the six test directions, functionally check and inspect the test item according to paragraph 4.4.1.1.

4.4.4 Procedure III - Crash Safety Test.

- Step 1. Install the test item and place it in its operational mode and orientation as in paragraph 4.4.1.2.
- Step 2. Bring the centrifuge to the speed required to induce the specified g level in the test item as determined from paragraph 2.3 and table 513.5-III for the particular test item orientation. Maintain this g level for at least one minute after the centrifuge rpm has stabilized.

- Step 3. Inspect the test item as specified in paragraph 4.4.1.1.
- Step 4. Repeat this test procedure for the remaining five test directions noted in paragraph 4.4.1.2.a Step 2.
- Step 5. Upon completing the tests in the six test directions inspect the test item as specified in paragraph 4.4.1.1.

5. ANALYSIS OF RESULTS.

5.1 General.

Refer to the guidance in Part One, paragraphs 5.14 and 5.17, and to Part One, Annex A, Tasks 405 and 406.

5.2 Specific to this Method.

5.2.1 Structural test.

A test is successful if the test item is undamaged and fully functional at test completion.

5.2.2 Operational test.

A test is successful if the test item is fully functional at test accelerations and is undamaged and fully functional at test completion.

5.2.3 Crash safety test.

A test is successful if the test item remains structurally attached to the mounts and no parts, pieces, or contents are detached from the item at test completion.

6. REFERENCE/RELATED DOCUMENTS.

- a. Junker, V.J., The Evolution of USAF Environmental Testing. October 1965; AFFDL TR 65-197; DTIC No. AD 625543.
- b. Handbook for Dynamic Data Acquisition and Analysis, IES-RP-DTE012.1, Institute of Environmental Sciences, 940 East Northwest Highway, Mount Prospect, Illinois 60056.

MIL-STD-810F
1 January 2000

THIS PAGE INTENTIONALLY BLANK

METHOD 514.5**VIBRATION****CONTENTS**

| <u>Paragraph</u> | <u>Page</u> |
|---|-------------|
| 1. SCOPE..... | 1 |
| 1.1 Purpose..... | 1 |
| 1.2 Application..... | 1 |
| 1.3 Limitations..... | 2 |
| 2. TAILORING GUIDANCE..... | 2 |
| 2.1 Selecting the Method..... | 2 |
| 2.1.1 Effects of environment..... | 3 |
| 2.1.2 Sequence..... | 3 |
| 2.2 Selecting Procedures..... | 4 |
| 2.2.1 Procedure selection considerations..... | 4 |
| 2.2.2 Difference among procedures..... | 4 |
| 2.3 Determine Test Levels and Conditions..... | 5 |
| 2.3.1 Climatic conditions..... | 5 |
| 2.3.2 Test item configuration..... | 7 |
| 2.4 Test Item Operation..... | 7 |
| 3. INFORMATION REQUIRED..... | 7 |
| 3.1 Pretest..... | 7 |
| 3.2 During Test..... | 8 |
| 3.3 Post-Test..... | 8 |
| 4. TEST PROCESS..... | 8 |
| 4.1 Test Facility..... | 8 |
| 4.1.1 Procedure I - General vibration..... | 9 |
| 4.1.2 Procedure II - Loose cargo transportation..... | 9 |
| 4.1.3 Procedure III - Large assembly transportation..... | 9 |
| 4.1.4 Procedure IV - Assembled aircraft store captive carriage and free flight..... | 9 |
| 4.2 Controls..... | 9 |
| 4.2.1 Control strategy..... | 10 |
| 4.2.1.1 Acceleration input control strategy..... | 10 |
| 4.2.1.2 Force control strategy..... | 10 |
| 4.2.1.3 Acceleration limit strategy..... | 10 |
| 4.2.1.4 Acceleration response control strategy..... | 10 |
| 4.2.1.5 Open loop waveform control strategy..... | 10 |
| 4.2.2 Tolerances..... | 11 |
| 4.2.2.1 Acceleration spectral density..... | 11 |
| 4.2.2.2 Peak sinusoidal acceleration..... | 11 |
| 4.2.2.3 Frequency measurement..... | 11 |
| 4.2.2.4 Cross axis accelerations..... | 12 |

MIL-STD-810F
1 January 2000

CONTENTS - Continued

| <u>Paragraph</u> | <u>Page</u> |
|------------------|-------------|
| 4.3 | 12 |
| 4.4 | 12 |
| 4.4.1 | 12 |
| 4.4.2 | 12 |
| 4.4.3 | 13 |
| 4.4.4 | 14 |
| 4.5 | 15 |
| 4.5.1 | 15 |
| 4.5.1.1 | 15 |
| 4.5.1.2 | 15 |
| 4.5.2 | 16 |
| 4.5.3 | 17 |
| 4.5.4 | 17 |
| 4.5.5 | 17 |
| 5. | 19 |
| 5.1 | 19 |
| 5.2 | 20 |
| 5.3 | 20 |
| 6. | 20 |

TABLE

| | |
|--|---|
| TABLE 514-I. Vibration environment categories..... | 6 |
|--|---|

ANNEX A. TAILORING GUIDANCE FOR VIBRATION EXPOSURE DEFINITION

| | |
|-----------|----------|
| 1. | 1 |
| 1.1 | 1 |
| 1.2 | 1 |
| 2. | 1 |
| 2.1 | 1 |
| 2.1.1 | 1 |
| 2.1.2 | 2 |
| 2.1.3 | 2 |
| 2.2 | 2 |
| 2.2.1 | 3 |
| 2.2.2 | 4 |
| 2.2.3 | 4 |
| 2.2.4 | 5 |
| 2.2.5 | 5 |
| 2.2.6 | 6 |
| 2.2.7 | 6 |

METHOD 514.5

CONTENTS - Continued

| <u>Paragraph</u> | | <u>Page</u> |
|------------------|---|-------------|
| 2.2.8 | Category 11 - Railroad - train..... | 7 |
| 2.3 | Operational Service..... | 7 |
| 2.3.1 | Category 12 - Fixed wing aircraft - jet aircraft..... | 7 |
| 2.3.2 | Category 13 - Fixed wing aircraft - propeller aircraft..... | 8 |
| 2.3.3 | Category 14 - Rotary wing aircraft - helicopter..... | 9 |
| 2.3.4 | Category 15 - Aircraft stores - assembled, jet aircraft..... | 10 |
| 2.3.5 | Category 16 - Aircraft stores - materiel, jet aircraft..... | 13 |
| 2.3.6 | Category 17 - Aircraft stores - assembled/materiel, propeller aircraft..... | 14 |
| 2.3.7 | Category 18 - Aircraft stores - assembled/materiel, helicopter..... | 14 |
| 2.3.8 | Category 19 - Missiles - Tactical missiles (free flight)..... | 14 |
| 2.3.9 | Category 20 - Ground vehicles - ground mobile..... | 15 |
| 2.3.10 | Category 21 - Watercraft - marine vehicles..... | 15 |
| 2.3.11 | Category 22 - Engines - turbine engines..... | 16 |
| 2.3.12 | Category 23 - Personnel - materiel carried by/on personnel..... | 16 |
| 2.4 | Supplemental Considerations..... | 17 |
| 2.4.1 | Category 24 - All materiel - minimum integrity test..... | 17 |
| 2.4.2 | Category 25 - All vehicles - cantilevered external materiel..... | 17 |

ANNEX B. ENGINEERING INFORMATION

| | | |
|-----------|--|----------|
| 1 | SCOPE..... | 1 |
| 1.1 | Purpose..... | 1 |
| 1.2 | Application..... | 1 |
| 2. | ENGINEERING INFORMATION..... | 1 |
| 2.1 | Vibration Test Types..... | 1 |
| 2.1.1 | Development test..... | 1 |
| 2.1.2 | Qualification test..... | 1 |
| 2.1.3 | Functional test..... | 2 |
| 2.1.4 | Endurance test..... | 2 |
| 2.1.5 | Durability test..... | 2 |
| 2.1.6 | Reliability test..... | 3 |
| 2.1.7 | Worthiness test..... | 3 |
| 2.1.8 | Environmental Stress Screen (ESS)..... | 3 |
| 2.2 | Fatigue Relationship..... | 3 |
| 2.3 | Vibration Characterization..... | 4 |
| 2.3.1 | Random vibration..... | 4 |
| 2.3.2 | Sinusoidal vibration..... | 5 |
| 2.3.3 | Mixed broadband and narrowband vibration..... | 5 |
| 2.3.4 | Transient vibration..... | 5 |
| 2.3.5 | Random versus sinusoidal vibration equivalence..... | 5 |
| 2.4 | Platform/Materiel and Fixture/Test Item Interaction..... | 6 |
| 2.4.1 | Mechanical impedance..... | 6 |
| 2.4.2 | Vibration isolation..... | 6 |
| 2.4.3 | Materiel resonant frequency variation..... | 7 |
| 2.5 | Modal Test and Analysis..... | 7 |
| 2.5.1 | Modal test techniques..... | 7 |

MIL-STD-810F
1 January 2000

CONTENTS - Continued

| <u>Paragraph</u> | <u>Page</u> |
|------------------|-------------|
| 2.5.2 | 8 |
| 2.6 | 8 |
| 2.6.1 | 8 |
| 2.6.2 | 8 |
| 2.6.3 | 9 |
| 2.7 | 9 |
| 2.7.1 | 9 |
| 2.7.2 | 9 |
| 2.7.3 | 9 |
| 2.7.4 | 10 |
| 2.7.5 | 10 |
| 2.7.6 | 11 |

ANNEX C. TABLES AND FIGURES

| | | |
|-----------|--|----------|
| 1. | SCOPE | 1 |
| 1.1 | Purpose | 1 |
| 2. | TABLES | 1 |
| | TABLE 514.5C-I. Typical mission / field transportation scenario | 1 |
| | TABLE 514.5C-II. Propeller aircraft vibration exposure | 1 |
| | TABLE 514.5C-III. Jet aircraft vibration exposure | 2 |
| | TABLE 514.5C-IV. Helicopter vibration exposure | 3 |
| | TABLE 514.5C-V. Jet aircraft external store vibration exposure | 4 |
| | TABLE 514.5C-VI. Dynamic pressure calculation | 5 |
| | TABLE 514.5C-VII. Break points for curves of figures 514.5C-1 through 514.5C-3 | 6 |
| | TABLE 514.5C-VIII. Break points for figure 514.5C-6 | 7 |
| 3. | FIGURES | 8 |
| | FIGURE 514.5C-1. U. S. highway truck vibration exposure | 8 |
| | FIGURE 514.5C-2. Composite two-wheeled trailer vibration exposure | 8 |
| | FIGURE 514.5C-3. Composite wheeled vehicle vibration exposure | 9 |
| | FIGURE 514.5C-4. Tracked vehicle representative spectral shape | 9 |
| | FIGURE 514.5C-5. Loose cargo test setup | 10 |
| | FIGURE 514.5C-6. Jet aircraft cargo vibration exposure | 10 |
| | FIGURE 514.5C-7. Rail cargo vibration exposure | 11 |
| | FIGURE 514.5C-8. Jet aircraft vibration exposure | 11 |
| | FIGURE 514.5C-9. Propeller aircraft vibration exposure | 12 |
| | FIGURE 514.5C-10. Helicopter vibration exposure | 12 |
| | FIGURE 514.5C-11. Helicopter vibration zones | 13 |
| | FIGURE 514.5C-12. Jet aircraft store vibration response | 13 |
| | FIGURE 514.5C-13. Jet aircraft store buffet response | 14 |
| | FIGURE 514.5C-14. Jet aircraft store equipment vibration exposure | 14 |
| | FIGURE 514.5C-15. Shipboard random vibration exposure | 15 |
| | FIGURE 514.5C-16. Turbine engine vibration exposure | 15 |
| | FIGURE 514.5C-17. General minimum integrity exposure | 16 |
| | FIGURE 514.5C-18. Helicopter minimum integrity exposure | 16 |

METHOD 514.5

METHOD 514.5

VIBRATION

NOTES:

Tailoring is essential. Select methods, procedures, and parameter levels based on the tailoring process described in Part One, paragraph 4, and Appendix C. Apply the general guidelines for laboratory test methods described in Part One, paragraph 5 of this standard.

Organization. The main body of this method is arranged similarly to the other methods of MIL-STD-810F. A considerable body of supplementary information is included in the Annexes. With the exception of table 514.5-I, all tables and figures for the entire method are in Annex C. Reference citations to external documents are at the end of the main body (paragraph 6). The annexes are as follows:

ANNEX A - TAILORING GUIDANCE FOR VIBRATION EXPOSURE DEFINITION

ANNEX B - ENGINEERING INFORMATION

ANNEX C - TABLES AND FIGURES

1. SCOPE.

1.1 Purpose.

Vibration tests are performed to:

- a. Develop materiel to function in and withstand the vibration exposures of a life cycle including synergistic effects of other environmental factors, materiel duty cycle, and maintenance. Combine the guidance of this method with the guidance of Part One and other methods herein to account for environmental synergism.
- b. Verify that materiel will function in and withstand the vibration exposures of a life cycle.

1.2 Application.

- a. General. Use this method for all types of materiel except as noted in MIL-STD-810F, Part One, paragraph 1.3 and as stated in section 1.3 below. For combined environment tests, conduct the test in accordance with the applicable test documentation. However, use this method for determination of vibration test levels, durations, data reduction, and test procedure details.
- b. Purpose of test. The test procedures and guidance herein are adaptable to various test purposes including development, reliability, qualification, etc. See Annex B for definitions and guidance.
- c. Vibration life cycle. Table 514.5-I provides an overview of various life cycle situations during which some form of vibration may be encountered, along with the anticipated platform involved. Annex A provides guidance for estimating vibration levels and durations and for selection of test procedures. Annex B provides definitions and engineering guidance useful in interpreting and applying this method. International Test Operations Procedure (ITOP) 1-2-601 (ref d) includes an assortment of specific ground vehicle and helicopter vibration data.
- d. Manufacturing. The manufacture and acceptance testing of materiel involves vibration exposures. These exposures are not directly addressed herein. It is assumed that the manufacturing and acceptance process completed on the units that undergo environmental testing are the same as the process used to produce deliverable units. Thus the environmental test unit(s) will have accumulated the same damage prior to test as a delivered unit accumulates prior to delivery. The environmental test then verifies the field life of

MIL-STD-810F
1 January 2000

delivered units. When a change is made to the manufacturing process that involves increased vibration exposure, evaluate this increased vibration exposure to ensure the field life of subsequent units is not shortened. An example might be a pre-production unit completely assembled in one building, whereas production units are partially assembled at one site and then transported to another site for final assembly. Such exposures could be incorporated as pre-conditioning to the test program.

- e. Environmental Stress Screen (ESS). Many materiel items are subjected to ESS, burn-in, or other production acceptance test procedures prior to delivery to the government and sometimes during maintenance. As in basic production processes, it is assumed that both the test units and the field units receive the same vibration exposures so that environmental test results are valid for the field units. Where units do not necessarily receive the same exposures, such as multiple passes through ESS, apply the maximum allowable exposures to the units used for environmental test as pre-conditioning for the environmental tests. (See Annex A, paragraph 2.1.3 and Annex B, paragraph 2.1.8.)

1.3 Limitations.

- a. Safety testing. This method may be used to apply specific safety test requirements as coordinated with the responsible safety organization. However, vibration levels or durations for specific safety related issues are not provided or discussed.
- b. Platform/materiel interaction. In this method, vibration requirements are generally expressed as inputs to materiel that is considered to be a rigid body with respect to the vibration exciter (platform, shaker, etc.). While this is often not true, it is an acceptable simplification for smaller materiel items. For large materiel items, it is necessary to recognize that the materiel and the exciter vibrate as a single flexible system. There is no simple rule to determine the validity of this assumption (see Annex B, paragraph 2.4). Further, proper treatment of a given materiel item may vary with platform. An example might be a galley designed for an aircraft. For the operational environment, installation on an operating aircraft, consider the galley structure as aircraft secondary structure, and design and test accordingly. Design subassemblies within the galley (e.g., coffee maker) for vibration levels based on guidance of Annex A and tested in accordance with Procedure I. When packaged for shipment, the packaging, galley, and subassemblies are considered a single materiel item, and tested accordingly. Another example is a shelter transported to the field as a pre-assembled office, laboratory, etc. Consider the shelter as large materiel and develop accordingly. A suitable test would be the large assembly transport test of paragraph 4.4.3. Where impedance mismatch between platform/materiel and laboratory vibration exciter/test item are significantly different, force control or acceleration limiting control strategies may be required to avoid unrealistically severe vibration response (see paragraph 4.2). Control limits should be based upon field and laboratory measurements. For sensitive materiel for which over-conservative testing philosophy must not be applied, force or acceleration limiting control is an option. In certain cases in which the field measured response is well defined on a small component, the duration of the vibration is short, then execution of the laboratory test under open loop waveform control based upon the field measured data is an option.
- c. Manufacture and maintenance. Vibration associated with processes at the manufacturer's facility, or experienced during maintenance is not addressed herein. Guidance concerning transportation environments may be applicable to transportation elements of manufacture or maintenance processes.
- d. Environmental Stress Screen (ESS). No guidance for selection of ESS exposures is contained herein. Some discussion is in Annex A, paragraph 2.1.3.

2. TAILORING GUIDANCE.

2.1 Selecting the Method.

Essentially all materiel will experience vibration, whether during manufacture, transportation, maintenance, or operational use. The procedures of this method address most of the life cycle situations during which vibration is likely to be experienced. Select the procedure or procedures most appropriate for the materiel to be tested and the

environment to be simulated. See table 514.5-I for a general listing of vibration exposures and test procedures as related to environmental life cycle elements. See Annex A for guidance on determining vibration levels and durations.

- a. Conservatism in selection of levels. In the past, vibration test criteria often contained added margin to account for variables that cannot be included in criteria derivation. These include (among many others) undefined worst case situations, synergism with other environmental factors (temperature, acceleration, etc.), and three-axis orthogonal versus three dimensional vibration. Due to strong pressure toward minimum cost and weight, this margin is often not included. When margin is not included, be aware that any improvements in weight or cost are purchased with added risk to materiel life and function.
- b. Conservatism with measured data. The guidance in this document encourages the use of materiel-specific measured data as the basis for vibration criteria. Due to limitations in numbers of transducers, accessibility of measurement points, linearity of data at extreme conditions, and other causes, measurements do not include all extreme conditions. Further, there are test limitations such as single axis versus multi-axis, and practical fixtures versus platform support. Apply margin to measured data in deriving test criteria to account for these variables. When sufficient measured data are available, use statistical methods as shown in method 516.5.
- c. Conservatism with predicted data. Annex A of this method and other sources such as the Mission Environmental Requirements Integration Technology (MERIT) computer program provide information which can be used to generate alternate criteria for those cases where measured data are unavailable. These data are based on envelopes of wide ranges of cases and are conservative for any one case. Additional margin is not recommended.

2.1.1 Effects of environment.

Vibration results in dynamic deflections of and within materiel. These dynamic deflections and associated velocities and accelerations may cause or contribute to structural fatigue and mechanical wear of structures, assemblies, and parts. In addition, dynamic deflections may result in impacting of elements and/or disruption of function. Some typical symptoms of vibration-induced problems follow. This list is not intended to be all-inclusive:

- a. Chafed wiring.
- b. Loose fasteners/components.
- c. Intermittent electrical contacts.
- d. Electrical shorts.
- e. Deformed seals.
- f. Failed components.
- g. Optical or mechanical misalignment.
- h. Cracked and/or broken structures.
- i. Migration of particles and failed components.
- j. Particles and failed components lodged in circuitry or mechanisms.
- k. Excessive electrical noise.
- l. Fretting corrosion in bearings.

2.1.2 Sequence.

Tailor the test sequence as a function of the life cycle environments of the specific Program (See Part One, paragraph 5.5).

MIL-STD-810F
1 January 2000

- a. General. The accumulated effects of vibration-induced stress may affect materiel performance under other environmental conditions such as temperature, altitude, humidity, leakage, or electromagnetic interference (EMI/EMC). When evaluating the cumulative environmental effects of vibration and other environments, expose a single test item to all environmental conditions, with vibration testing generally performed first. If another environment (e.g., temperature cycling) is projected to produce damage that would make the materiel more susceptible to vibration, perform tests for that environment before vibration tests. For example, thermal cycles might initiate a fatigue crack that would grow under vibration or vice versa.
- b. Unique to this method. Generally, expose the test item to the sequence of individual vibration tests that follow the sequence of the life cycle. For most tests, this can be varied if necessary to accommodate test facility schedules or for other practical reasons. However, always perform some tests in the life cycle sequence. Complete all manufacture associated preconditioning (including ESS) before any of the vibration tests. Complete any maintenance associated preconditioning (including ESS) prior to tests representing mission environments. Perform tests representing critical end-of-mission environments last.

2.2 Selecting Procedures.

Identify the environments of the materiel life cycle during the tailoring process as described in Part One. Table 514.5-I provides a list of vibration environments by category versus test procedure. Descriptions of each category listed in this table are included in Annex A along with information for tailoring the test procedures of paragraph 4 below, and alternate test criteria for use when measured data are not available. In general, test materiel for each category to which it will be exposed during an environmental life cycle. Tailor test procedures to best accomplish the test purpose (see Annex B, paragraph 2.1), and to be as realistic as possible (Annex A, paragraph 1.2).

2.2.1 Procedure selection considerations.

Depending on relative severity, it may be acceptable to delete vibration tests representing particular life cycle elements for a materiel test program. Base such decisions on consideration of both vibration amplitude and fatigue damage potential across the frequency range of importance. Make analytical estimates of fatigue damage potential on the basis of simple, well-understood models of the materiel.

- a. Transportation vibration more severe than application environment. Transportation vibration levels are often more severe than application vibration levels for ground-based and some shipboard materiel. In this case, both transportation and platform vibration tests are usually needed because the transportation test is performed with the test item non-operating and the platform test is performed with the test item operating.
- b. Application vibration more severe than transportation vibration. If the application vibration levels are more severe than the transportation levels, it may be feasible to delete transportation testing. It may also be feasible to change the application test spectrum shape or duration to include transportation requirements in a single test. In aircraft applications, a minimum integrity test (see Annex A, paragraph 2.4.1) is sometimes substituted for transportation and maintenance vibration requirements.
- c. Transportation configuration versus application configuration. In evaluation of the relative severity of environments, include the differences in transportation configuration (packaging, shoring, folding, etc.) and application configuration (mounted to platform, all parts deployed for service, etc.). In addition, transportation environments are usually defined as inputs to the packaging, whereas application environments are expressed as inputs to the materiel mounting structure or as response of the materiel to the environment.

2.2.2 Difference among procedures.

- a. Procedure I - General Vibration. Use Procedure I for those cases where a test item is secured to a vibration exciter and vibration is applied to the test item at the fixture/test item interface. Steady state or transient vibration may be applied as appropriate.

METHOD 514.5

- b. Procedure II - Loose Cargo Transportation. Use this procedure for materiel to be carried in/on trucks, trailers, or tracked vehicles and not secured to (tied down in) the carrying vehicle. The test severity is not tailorable and represents loose cargo transport in military vehicles traversing rough terrain.
- c. Procedure III - Large Assembly Transportation. This procedure is intended to replicate the vibration and shock environment incurred by large assemblies of materiel installed or transported by wheeled or tracked vehicles. It is applicable to large assemblies or groupings forming a high proportion of vehicle mass, and to materiel forming an integral part of the vehicle. In this procedure, use the specified vehicle type to provide the mechanical excitation to the test materiel. The vehicle is driven over surfaces representative of service conditions, resulting in realistic simulation of both the vibration environment and the dynamic response of the test materiel to the environment. Generally, measured vibration data are not used to define this test. However, measured data are often acquired during this test to verify that vibration and shock criteria for materiel subassemblies are realistic.
- d. Procedure IV - Assembled Aircraft Store Captive Carriage and Free Flight. Apply Procedure IV to fixed wing aircraft carriage and free flight portions of the environmental life cycles of all aircraft stores, and to the free flight phases of ground or sea launched missiles. Use Procedure I, II or III for other portions of the store's life cycle as applicable. Steady state or transient vibration may be applied as appropriate. Do not apply Procedure I to fixed wing aircraft carriage or free flight phases.

2.3 Determine Test Levels and Conditions.

Select excitation form (steady state or transient), excitation levels, control strategies, durations and laboratory conditions to simulate the vibration exposures of the environmental life cycle as accurately as possible. Whenever possible, acquire measured data as a basis for these parameters. Annex A includes descriptions of various phases typical of an environmental life cycle along with discussions of important parameters and guidance for developing test parameters. Annex B has further guidance in interpretation of technical detail.

2.3.1 Climatic conditions.

Many laboratory vibration tests are conducted under Standard Ambient Test Conditions as discussed in Part One, paragraph 5. However, when the life cycle events being simulated occur in environmental conditions significantly different than standard conditions, consider applying those environmental factors during vibration testing. Individual climatic test methods of this standard include guidance for determining levels of other environmental loads. Methods 520.2, "Temperature, Humidity, Vibration, Altitude," and 523.2, "Vibro-Acoustic/Temperature," contain specific guidance for combined environments testing.

MIL-STD-810F
1 January 2000

TABLE 514.5-I. Vibration environment categories.

| Life Phase | Platform | Category | Materiel Description | Level & Duration Annex A | Test ^{1/} | |
|---|---------------------------------------|--|---|--------------------------|--------------------|---|
| Manufacture / Maintenance | Plant Facility / Maintenance Facility | 1. Manufacture / Maintenance processes | Materiel / assembly / part | 2.1.1 | ^{2/} | |
| | | 2. Shipping, handling | Materiel / assembly / part | 2.1.2 | ^{2/} | |
| | | 3. ESS | Materiel / assembly / part | 2.1.3 | ^{3/} | |
| Transportation | Truck / Trailer / Tracked | 4. Restrained Cargo | Materiel as restrained cargo ^{4/} | 2.2.1 | I | |
| | | 5. Loose Cargo | Materiel as loose cargo ^{4/} | 2.2.2 | II | |
| | | 6. Large Assembly Cargo | Large assemblies, shelters, van and trailer units ^{4/} | 2.2.3 | III | |
| | Aircraft | 7. Jet | Materiel as cargo | 2.2.4 | I | |
| | | 8. Propeller | Materiel as cargo | 2.2.5 | I | |
| | | 9. Helicopter | Materiel as cargo | 2.2.6 | I | |
| | Ship | 10. Surface Ship | Materiel as cargo | 2.2.7 | I | |
| | Railroad | 11. Train | Materiel as cargo | 2.2.8 | I | |
| | Operational | Aircraft | 12. Jet | Installed Materiel | 2.3.1 | I |
| | | | 13. Propeller | Installed Materiel | 2.3.2 | I |
| | | | 14. Helicopter | Installed Materiel | 2.3.3 | I |
| Aircraft Stores | | 15. Jet | Assembled stores | 2.3.4 | IV | |
| | | 16. Jet | Installed in stores | 2.3.5 | I | |
| | | 17. Propeller | Assembled / Installed in stores | 2.3.6 | IV/I | |
| Missiles | | 18. Helicopter | Assembled / installed in stores | 2.3.7 | IV/I | |
| | | 19. Tactical Missiles | Assembled / installed in missiles (free flight) | 2.3.8 | IV/I | |
| Ground | | 20. Ground Vehicles | Installed in wheeled / tracked / trailer | 2.3.9 | I/III | |
| Watercraft | | 21. Marine Vehicles | Installed Materiel | 2.3.10 | I | |
| Engines | | 22. Turbine Engines | Materiel Installed on | 2.3.11 | I | |
| Personnel | | 23. Personnel | Materiel carried by/on personnel | 2.3.12 | ^{2/} | |
| Supplemental | All | 24. Minimum Integrity | Installed on Isolators / Life cycle not defined | 2.4.1 | I | |
| | All Vehicles | 25. External Cantilevered | Antennae, airfoils, masts, etc. | 2.4.2 | ^{2/} | |
| ^{1/} Test procedure – see paragraph 4 ^{2/} See Annex A reference. ^{3/} Use applicable ESS procedure. ^{4/} See paragraph 2.3.2. | | | | | | |

2.3.2 Test item configuration.

Configure the test item for each test, as it will be in the corresponding life cycle phase. In cases representing transportation, include all packing, shoring, padding, or other configuration modifications of the particular shipment mode. The transportation configuration may be different for different modes of transportation.

- a. Loose cargo. The method contained herein is a general representation based on experience as well as measurement, and is not tailorable (see Annex A, paragraph 2.2.2 for details). The most realistic alternative for truck, trailer, or other ground transportation is to utilize Procedure III. Note that Procedure III requires the transportation vehicle and a full cargo load.
- b. Restrained cargo. Procedure I assumes no relative motion between the vehicle cargo deck or cargo compartment and the cargo. This applies directly to materiel that is tied down or otherwise restrained such that no relative motion is allowed considering vibration, shock, and acceleration loads. When restraints are not used or are such as to allow limited relative motions, provide allowance in the test set up and in the vibration excitation system to account for this motion. Procedure III is an alternative for ground transportation.
- c. Stacked cargo. Stacking or bundling of sets or groups of materiel items may effect the vibration transmitted to individual items. Ensure the test item configuration includes appropriate numbers and groupings of materiel items.

2.4 Test Item Operation.

Whenever practical, ensure test items are active and functioning during vibration tests. Monitor and record achieved performance. Obtain as much data as possible that defines the sensitivity of the materiel to vibration. Where tests are conducted to determine functional capability while exposed to the environment, function the test item. In other cases, function the item where practical. Functioning during transportation will not be possible in almost all cases. Also, there are cases where the functional configuration varies with mission phase, or where operation at high levels of vibration may not be required and may be likely to result in damage.

3. INFORMATION REQUIRED.

The following information is required to conduct and document vibration tests adequately. Tailor the lists to the specific circumstances, adding or deleting items as necessary. Although generally not required in the past, perform fixture and materiel modal surveys when practical. These data are useful in evaluating test results, and in evaluating the suitability of materiel against changing requirements or for new applications. These data can be particularly valuable in future programs where the major emphasis will be to utilize existing materiel in new applications. (When modal survey is ruled out for programmatic reasons, a simple resonance search can sometimes provide useful information.)

3.1 Pretest.

- a. General. See Part One, paragraphs, 5.7 and 5.9, and Appendix A, Tasks 405 and 406 of this standard.
- b. Specific to this method.
 - (1) Test fixture requirements.
 - (2) Test fixture modal survey procedure.
 - (3) Test item/fixture modal survey procedure.
 - (4) Vibration exciter control strategy.
 - (5) Test tolerances.
 - (6) Requirements for combined environments.

MIL-STD-810F
1 January 2000

- (7) Test schedule(s) and duration of exposure(s).
 - (8) Axes of exposure.
 - (9) Measurement instrumentation configuration.
 - (10) Test shutdown procedures for test equipment or test item problems, failures, etc.
 - (11) Test interruption recovery procedure.
 - (12) Test completion criteria.
- c. Specific to Procedure.
- (1) Procedure II - Loose cargo vibration. Define the orientation of test item(s) in relation to the axis of throw of the test table.
 - (2) Procedure III - Large assembly transportation. Define the test vehicle(s), loading(s), surface(s), distance(s), and speed(s).

NOTE: Modal surveys of both test fixtures and test items can be extremely valuable. Large test items on large complex fixtures are almost certain to have fixture resonances within the test range. These resonances result in large overtests or undertests at specific frequencies and locations within a test item. Where fixture and test item resonances couple, the result can be catastrophic. Similar problems often occur with small test items, even when the shaker/fixture system is well designed because it is very difficult and often impractical to achieve a lowest fixture resonant frequency above 2000 Hz. In cases where the fixture/item resonance coupling cannot be eliminated, consider special vibration control techniques such as acceleration or force limit control.

3.2 During Test.

Collect the information listed in Part One, paragraph 5.10, and in Appendix A, Tasks 405 and 406 of this standard.

3.3 Post-Test.

- a. General. See Part One, paragraph 5.13, and Appendix A, Task 406 of this standard.
- b. Specific to this method.
 - (1) Summary and chronology of test events, test interruptions, and test failures.
 - (2) Discussion and interpretation of test events.
 - (3) Functional verification data.
 - (4) Test item modal analysis data.
 - (5) Fixture modal analysis data.
 - (6) All vibration measurement data.

4. TEST PROCESS.

Tailor the following sections as appropriate for the individual contract or program. Note that if these sections are directly referenced in a contract, they will generally not comply with current and future Department of Defense requirements for contractual language.

4.1 Test Facility.

Use a test facility, including all auxiliary equipment, capable of providing the specified vibration environments and the control strategies and tolerances discussed in paragraph 4.2. In addition, use measurement transducers, data recording and data reduction equipment capable of measuring, recording, analyzing and displaying data sufficient to

document the test and to acquire any additional data required. Unless otherwise specified, perform the specified vibration tests and take measurements at standard ambient conditions as specified in Part One, paragraph 5.1.

4.1.1 Procedure I - General vibration.

This procedure utilizes standard laboratory vibration exciters (shakers), slip tables, and fixtures. Choose the specific exciters to be used based on size and mass of test items and fixtures, the frequency range required, and the low frequency stroke length (displacement) required.

4.1.2 Procedure II - Loose cargo transportation.

Simulation of this environment requires use of a package tester (figure 514.5C-5) that imparts a 25.4 mm (1.0 inch) peak-to-peak, circular motion to the table at a frequency of 5 Hz. This motion takes place in a vertical plane. The figure shows the required fixturing. This fixturing does not secure the test item(s) to the bed of the package tester. Ensure the package tester is large enough for the specific test item(s) (dimensions and weight).

- a. Test bed. Cover the test bed of the package tester with a cold rolled steel plate (see note), 5 to 10 mm (0.2 to 0.4 in) thick, and secure the plate with bolts, the tops of the heads of which are slightly below the surface. Space the bolts at sufficient intervals around the four edges and through the center area to prevent diaphragming of the steel plate. Do not start a test on an area of steel plate that is severely damaged or worn through.
- b. Fencing. The fence opposite the vertical impact wall is not intended as an impact surface, but is used to restrain the test item from leaving the tester. The distance to this restraining fence should be sufficient to prevent constant impact, but still prevent one or more of multiple test items from “walking” away from the others. The height of the test enclosure (sideboards, impact wall, and restraining fence) should be at least 5 cm higher than the height of the test item to prevent unrealistic impacting of the test item on the top of the enclosure.

Note: Comparison of plywood bed and steel bed data show no statistical difference. Also, steel bed requires less maintenance and U. S. Army trucks use steel beds. See reference a.

4.1.3 Procedure III - Large assembly transportation.

The test facility for this method is a test surface(s) and vehicle(s) representative of transportation and/or service phases of the environmental life cycle. The test item is loaded on the vehicle and restrained or mounted to represent the life cycle event. The vehicle is then driven over the test surface in a manner that reproduces the transportation or service conditions. The test surfaces may include designed test tracks (e.g., test surfaces at the U. S. Army Aberdeen Test Center, reference b), typical highways, or specific highways between given points (e.g., a specified route between a manufacturing facility and a military depot). Potentially, such testing can include all environmental factors (vibration, shock, temperature, humidity, pressure, etc.) related to wheeled vehicle transport.

4.1.4 Procedure IV - Assembled aircraft store captive carriage and free flight.

This procedure utilizes standard laboratory vibration exciters (shakers) driving the test item directly or through a local fixture. The test item is supported by a test frame independent of the vibration exciters (see paragraph 4.4.4). Select the specific exciters based on size and mass of test items and fixtures, frequency range, and low frequency stroke length (displacement) required.

4.2 Controls.

The accuracy in providing and measuring vibration environments is highly dependent on fixtures and mountings for the test item, the measurement system and the exciter control strategy. Ensure all instrumentation considerations are in accordance with the best practices available (see reference c). Careful design of the test set up, fixtures, transducer mountings and wiring, along with good quality control will be necessary to meet the tolerances of paragraph 4.2.2 below.

MIL-STD-810F
1 January 2000

4.2.1 Control strategy.

Select a control strategy that will provide the required vibration at the required location(s) in or on the test item. Base this selection on the characteristics of the vibration to be generated and platform/material interaction (see paragraph 1.3b above and Annex B, paragraph 2.4). Generally, a single strategy is appropriate. There are cases where multiple strategies are used simultaneously.

4.2.1.1 Acceleration input control strategy.

Input control is the traditional approach to vibration testing. Control accelerometers are mounted on the fixture at the test item mounting points. Exciter motion is controlled with feedback from the control accelerometer(s) to provide defined vibration levels at the fixture/test item interface. Where appropriate, the control signal can be the average of the signals from more than one test item/fixture accelerometer. This represents the platform input to the materiel and assumes that the materiel does not influence platform vibration.

4.2.1.2 Force control strategy.

Dynamic force gages are mounted between the exciter/fixture and the test item. Exciter motion is controlled with feedback from the force gages to replicate field measured interface forces. This strategy is used where the field (platform/materiel) dynamic interaction is significantly different from the laboratory (exciter/test item) dynamic interaction. This form of control inputs the correct field-measured forces at the interface of the laboratory vibration exciter and test item. This strategy is used to prevent overtest or undertest of materiel mounts at the lowest structural resonances that may otherwise occur with other forms of control.

4.2.1.3 Acceleration limit strategy.

Input vibration criteria is defined as in paragraph 4.2.1.1. In addition, vibration response limits at specific points on the materiel are defined (typically based on field measurements). Monitoring accelerometers are located at these points. The test item is excited as in paragraph 4.2.1.1 using test item mounting point accelerometer signals to control the exciters. The input criteria are experimentally modified as needed to limit responses at the monitoring accelerometers to the predefined limits. Changes to the specified input criteria are limited in frequency bandwidth and in level to the minimum needed to achieve the required limits.

4.2.1.4 Acceleration response control strategy.

Vibration criteria are specified for specific points on, or within the test item. Control accelerometers are mounted at the vibration exciter/fixture interface. Monitoring accelerometers are mounted at the specified points within the item. An arbitrary low level vibration, controlled with feedback from the control accelerometers, is input to the test item. The input vibration is experimentally adjusted until the specified levels are achieved at the monitoring accelerometers. This strategy is commonly used with assembled aircraft stores where store response to the dynamic environment is measured or estimated. It is also applicable for other materiel when field measured response data are available.

4.2.1.5 Open loop waveform control strategy.

Monitoring accelerometers are mounted at locations on/in the test item for which measured data are available. The exciter is driven by an appropriately compensated time/voltage waveform obtained directly from (1) field measured data, or (2) a specified digitized waveform, and monitor acceleration responses are measured. In general, the compensated voltage waveform will be determined in the same way that a voltage waveform is determined for a shock test, i.e., from a convolution of the desired response waveform with the system impulse response function. This strategy is not generally applicable to the procedures of method 514.5. It is more generally used for control of transient or short duration, time-varying random vibration of method 516.5.

4.2.2 Tolerances.

Use the following tolerances unless otherwise specified. In cases where these tolerances cannot be met, achievable tolerances should be established and agreed to by the cognizant engineering authority and the customer prior to initiation of test. Protect measurement transducer(s) to prevent contact with surfaces other than the mounting surface(s).

4.2.2.1 Acceleration spectral density.

Care must be taken to examine field measured response probability density information for non-Gaussian behavior. In particular, determine the relationship between the measured field response data and the laboratory replicated data relative to three sigma peak height limiting that may be introduced in the laboratory test.

- a. Vibration environment. Maintain the acceleration spectral density at a control transducer within +2.0 dB or -1.0 dB over the specified frequency range. This tolerance is usually readily attainable with small, compact test items (such as small and medium sized rectangular electronic packages), well-designed fixtures, and modern control equipment. When test items are large or heavy, when fixture resonances cannot be eliminated, or when steep slopes (> 20 dB/octave) occur in the spectrum, these tolerances may have to be increased. When increases are required, exercise care to ensure the selected tolerances are the minimum attainable, and that attainable tolerances are compatible with test objectives. In any case, tolerances should not exceed ± 3 dB over the entire test frequency range and +3, -6 above 500 Hz. These tolerances should be limited to a maximum of 5% of the test frequency range. Otherwise, change the tests, fixtures, or facilities so test objectives can be met. For Procedure IV, Assembled Aircraft Stores, the allowable deviation is ± 3 dB.
- b. Vibration measurement. Use a vibration measurement system that can provide acceleration spectral density measurements within ± 0.5 dB of the vibration level at the transducer mounting surface (or transducer target mounting surface) over the required frequency range. Do not use a measurement bandwidth that exceeds 2.5 Hz at 25 Hz or below or 5 Hz at frequencies above 25 Hz. For control and analysis systems of fast Fourier transform (FFT) type, use a resolution of at least 400 frequency lines. For wider frequency ranges the use of 800 frequency lines is recommended. Ensure the number of statistical degrees of freedom is not be less than 120.
- c. Root mean square (RMS) "g." Do not use RMS g for defining or controlling vibration tests because it contains no spectral information. RMS levels are useful in monitoring vibration tests since RMS can be monitored continuously, whereas measured spectra are available on a delayed, periodic basis. Also, RMS values are sometimes useful in detecting errors in test spectra definition. Define the tolerances on RMS g monitoring values based on the test variables and the test equipment. Do not use random vibration RMS g as a comparison with sinusoidal peak g. These values are unrelated.

4.2.2.2 Peak sinusoidal acceleration.

- a. Vibration environment. Ensure the peak sinusoidal acceleration at a control transducer does not deviate from that specified by more than $\pm 10\%$ over the specified frequency range.
- b. Vibration measurement. Ensure the vibration measurement system provides peak sinusoidal acceleration measurements within $\pm 5\%$ of the vibration level at the transducer mounting surface (or transducer target mounting surface) over the required frequency range.
- c. RMS g. The RMS g of a sinusoid equals 0.707 times peak g. It is not related to RMS g of a random (g^2/Hz) spectrum; do not use this to compare sine criteria (g) to random criteria (g^2/Hz).

4.2.2.3 Frequency measurement.

Ensure the vibration measurement system provides frequency measurements within $\pm 1.25\%$ at the transducer mounting surface (or transducer target mounting surface) over the required frequency range.

MIL-STD-810F
1 January 2000

4.2.2.4 Cross axis accelerations.

Ensure vibration acceleration in two axes mutually orthogonal and orthogonal to the drive axis is less than or equal to 0.45 times the acceleration (0.2 times the spectral density) in the drive axis at any frequency. In a random vibration test the cross axis acceleration spectral density often has high but narrow peaks. Consider these in tailoring cross-axis tolerances.

4.3 Test interruption.

- a. General. See Part One, paragraph 5.11, of this standard.
- b. Specific to this method.
 - (1) When interruptions are due to failure of the test item, analyze the failure to determine root cause. With this information, make a decision to restart, to replace, to repair failed components and resume, or to declare the test complete. Tailor this decision to the test and the test objectives. See Annex B, paragraph 2.1 for descriptions of common test types and a general discussion of test objectives.
 - (2) If a qualification test is interrupted because of a failed component and the component is replaced, continuation of the test from the point of interruption will not verify the adequacy of the replaced component. Each replaced component must experience the full vibration requirement prior to its acceptance. Additional guidance is provided in paragraph 5.2.

4.4 Test Setup.

See Part One, paragraph 5.8.

4.4.1 Procedure I - General vibration.

Configure the test item appropriately for the life cycle phase to be simulated.

- a. Transportation. Configure the test item for shipment including protective cases, devices, and/or packing. Mount the test item to the test fixture(s) by means of restraints and/or tie-downs dynamically representative of life cycle transportation events.
- b. Operational service. Configure the test item for service use. Secure the test item to the test fixture(s) at the mounting point(s) and use the same type of mounting hardware as used during life cycle operational service. Provide all mechanical, electrical, hydraulic, pneumatic or other connections to the materiel that will be used in operational service. Ensure these connections dynamically simulate the service connections and that they are fully functional unless otherwise specified.

4.4.2 Procedure II - Loose cargo transportation.

Two different setups of fencing are required depending on the type of test item. The two types are those that are more likely to slide on the test surface or "rectangular cross section items" (typically packaged items), and those most likely to roll on the surface or "circular cross section items." (Note that "multiple test items" refers to identical test items and not to a mixture of unrelated items.)

- a. Rectangular cross section items. Position the test item on the package tester bed in its most likely shipping orientation. If the most likely shipping orientation cannot be determined, place the test item on the bed with the longest axis of the test item parallel to the long axis of the table (throw axis). Position the wooden impact walls and sideboards so as to allow impacting on only one end wall (no rebounding) and to prevent rotation of the test item through 90 degrees. Do not separate multiple test items by sideboards. The first half of the test is to be conducted with this orientation. The second half is to be conducted with the orientation of the test item rotated 90 degrees.
- b. Circular cross section items with 4 or more test items. Place the impact walls so as to form a square test area with the walls parallel and perpendicular to the throw axis. Use the following formulae to determine

METHOD 514.5

the dimensions. Determine the slenderness ratio for individual test items by $R_T = L/D$, where R_T = the item slenderness ratio; L = the item length; D = the item diameter. Calculate an R_R value for defining the test area as follows:

$$R_R = N L / [0.767 L N^{1/2} - 2 S_W - (N-1) S_B]$$

where:

S_W = spacing between the test item and the side wall

S_B = spacing between test items

(S_W and S_B are chosen based on test item geometry to provide realistic impacting with impact walls and between test items. 25 mm is a typical value for both.)

N = number of test items where $N > 3$

If the $R_T > R_R$, the length of each side of the test area is given by "X" where:

$$X = 0.767 L N^{1/2}$$

If $R_T \leq R_R$, the length of each side of the test area is given by "W" where:

$$W = N D + 2 S_W + (N-1) S_B$$

- c. Circular cross section items with 3 or fewer test items. Determine the slenderness ratio for individual test items by $R_T = L/D$. Calculate an R_R value for defining the test area as follows:

$$R_R = N L / [1.5 L - 2 S_W - (N-1) S_B]$$

If $R_T > R_R$, the length of each side of the test area is given by "X" where:

$$X = 1.5 L$$

If $R_T \leq R_R$, the length of each side of the test area is given by "W" where:

$$W = N D + 2 S_W + (N-1) S_B$$

Place the test item on the package tester, inside the impact walls, in a random manner. Because part of the damage incurred during these tests is due to items impacting each other, use more than 3 test items if possible.

4.4.3 Procedure III - Large assembly transportation.

Install the test item in/on the vehicle in its intended transportation or service configuration. If the assembly is to be contained within a shelter, or if other units are attached to the materiel assembly in its in-service configuration, also install these items in their design configuration.

- Test surfaces. When setting up the test, consider the test surfaces available at the particular test location (see reference b). Also, ensure the selection of test surfaces, test distances, and test speeds are appropriate for the specified vehicles and their anticipated use.
- Test loads. Response of the vehicle to the test terrain is a function of the total load and the distribution of the load on the vehicle. In general, a harsher ride occurs with a lighter load while a heavier load will result in maximum levels at lower frequencies. Multiple test runs with variations in load may be required to include worst case, average, or other relevant cases.
- Tie-down/mounting arrangements. During the test, it is important to reproduce the more adverse arrangements that could arise in normal use. For example, during transportation, relaxation of tie-down strap tension could allow the cargo to lift off the cargo bed and result in repeated shock conditions. Excessive tightening of webbing straps could prevent movement of test items and thereby reduce or eliminate such shocks.

MIL-STD-810F
1 January 2000

4.4.4 Procedure IV - Assembled aircraft store captive carriage and free flight.

- a. Captive carriage test fixture. Suspend the test item from a structural support frame by means of the operational service store suspension equipment (bomb rack, launcher, pylon, etc.). Ensure that the flexible modes of the support frame are as high as practical, at least twice the first flexible frequency of the store, and that they do not coincide with store modes. Include and load (torque, clamp, latch, etc.) sway braces, lugs, hooks or other locking and load carrying devices that attach the store to the suspension equipment and the suspension equipment to the carrier aircraft, as required for captive carriage in service. Ensure that the layout of the structural support frame and the test area is such that there is adequate access for the vibration exciters and test material.
 - (1) Configure the assembled store for captive carriage and mount it to the structural support frame. Softly suspend the structural support frame within the test chamber. Ensure that rigid body modes of the store, suspension equipment, and structural support frame combination are between 5 and 20 Hz, and lower than one half the lowest flexible mode frequency of the store. Use structural support that is sufficiently heavy and of sufficient pitch and roll inertias to approximately simulate carrier aircraft dynamic reaction mass. If the structural support is too heavy or its inertia too large, the store suspension equipment and store hardback will be over-stressed. This is because unrealistically high dynamic bending moments are needed to match acceleration spectral densities. Conversely, if the structural support is too light or its inertia too low, there will be an undertest of the suspension equipment and store hardback.
 - (2) Do not use the structural support to introduce vibration into the store. In the past, stores have been hard mounted to large shakers. Do not attempt this because this has proven to be inadequate. Recent test experience with F-15, F-16, and F/A-18 stores indicates that including a structural support/reaction mass greatly improves the match between flight measured data and laboratory vibrations, particularly at lower frequencies.
 - (3) In cases in which the frequency requirements in (1) and (2) cannot be met, consider force control strategy (see paragraph 4.2.1.2).
- b. Free flight test fixture. Configure the assembled test store for free flight and softly suspend it within the test chamber. Ensure rigid body modes of the suspended store are between 5 and 20 Hz and lower than one half the lowest flexible mode frequency of the store.
- c. Orientation. With the store suspended for test, the longitudinal axis is the axis parallel to the ground plane and passing through the longest dimension of the store. The vertical axis is mutually perpendicular to the ground plane and the longitudinal axis. The lateral axis is mutually perpendicular to longitudinal and vertical axes.
- d. Vibration excitation. Store longitudinal vibration is typically less than vertical and lateral vibration. Vertical and lateral excitation of store modes usually results in sufficient longitudinal vibration. When a store is relatively slender (length greater than 4 times the height or width), drive the store in the vertical and lateral axes. In other cases, drive the store in the vertical, lateral, and longitudinal axes. If a store contains material that is not vibration tested except at assembled store level, or the store contains components that are sensitive to longitudinal vibration, include longitudinal excitation.
 - (1) Transmit vibration to the store by means of rods (stingers) or other suitable devices running from vibration exciters to the store. Separate drive points at each end of the store in each axis are recommended. Ideally, the store will be driven simultaneously at each end. However, it can be driven at each end separately. A single driving point in each axis aligned with the store aerodynamic center has also been successful. Use drive points on the store surface that are relatively hard and structurally supported by the store internal structure or by test fixture(s) (usually external rings around the local store diameter) that distribute the vibratory loads into the store primary structure.
 - (2) This test is intended to represent a highly random, highly uncorrelated vibration condition. Thus, when two vibration exciters are used simultaneously, the two drive signals are uncorrelated. Note that two drive signals that start out uncorrelated and that are from two separate controllers may

METHOD 514.5

become correlated unless uncorrelation is forced. In general, the use of two vibration exciters will require some knowledge of current dual drive testing capabilities that include specification of the vibration exciter cross spectral density matrices.

- e. **Instrumentation.** Mount transducers on the store and/or the store excitation devices to monitor compliance of vibration levels with requirements, to provide feedback signals to control the vibration exciter, and to measure materiel function. Additionally, it is usually important to overall program objectives to add transducers to measure local vibration environment throughout the store. Note the vibration exciter control strategy used, e.g., single point response, multipoint response, force limit, waveform, etc. Also note the relationship, if any, between field measurement data and laboratory measurement data.
- (1) Mount accelerometers to monitor vibration levels at the forward and aft extremes of the primary load carrying structure of the store. Do not mount these accelerometers on fairings, unsupported areas of skin panels, aerodynamic surfaces, or other relatively soft structures. In some cases (see paragraph 4.4.4c above), transducers are required in the vertical and lateral directions. In other cases, transducers are required in vertical, lateral, and longitudinal directions. Designate these transducers as the test monitor transducers.
 - (2) An alternate method is to monitor the test with strain gages that are calibrated to provide dynamic bending moment. This has proven successful where integrity of the store primary structure is a major concern. Flight measured dynamic bending moment data is required for this method. Also, use accelerometers positioned as discussed above to verify that general vibration levels are as required.
 - (3) As feedback control transducers, use either accelerometers on or near the store/vibration transmission device(s)/vibration exciter interface, force transducer(s) in series with the store/vibration transmission device(s)/vibration exciter, or dynamic bending moment strain gages. A clear understanding of the vibration exciter control strategy and its effects on the overall measurements is necessary.

4.5 Test Execution.

The following steps, alone or in combination, provide the basis for collecting necessary information concerning the durability and function of a test item in a vibration environment.

4.5.1 Preparation for test.

4.5.1.1 Preliminary steps.

Before starting test, review pretest information in the test plan to determine test details (procedure(s), test item configuration(s), levels, durations, vibration exciter control strategy, failure criteria, item functional requirements, instrumentation requirements, facility capability, fixture(s), etc.).

- a. Select appropriate vibration exciters and fixtures.
- b. Select appropriate data acquisition system (e.g., instrumentation, cables, signal conditioning, recording, analysis equipment).
- c. Operate vibration equipment without the test item installed to confirm proper operation.
- d. Ensure that the data acquisition system functions as required.

4.5.1.2 Pretest standard ambient checkout.

All items require a pretest standard ambient checkout to provide baseline data. Conduct the pretest checkout as follows:

- Step 1. Examine the test item for physical defects, etc. and document the results.

MIL-STD-810F
1 January 2000

- Step 2. Prepare the test item for test, in its operating configuration if required, as specified in the test plan.
- Step 3. Examine the test item/fixture/exciter combination for compliance with test item and test plan requirements.
- Step 4. If applicable, conduct an operational checkout in accordance with the test plan and document the results for comparison with data taken during or after the test.

4.5.2 Procedure I - General vibration.

- Step 1. Perform a visual inspection of the test item and an operational check. If a failure is noted, proceed as in paragraph 4.3.
- Step 2. Conduct fixture modal survey and verify that fixture meets requirements, if required.
- Step 3. Mount the test item to the test fixture in a manner dynamically representative of the life cycle event simulated.
- Step 4. Install sufficient transducers on or near the test item/fixture/vibration exciter combination to measure vibration at the test item/fixture interface, to control the vibration exciter as required by the control strategy, and measure any other required parameters. Mount control transducer(s) as close as possible to the test item/fixture interface. Ensure that the total accuracy of the instrumentation system is sufficient to verify that vibration levels are within the tolerances of paragraph 4.2.2 and to meet additionally specified accuracy requirements.
- Step 5. Conduct test item modal survey, if required.
- Step 6. Perform a visual inspection of the test item and, if applicable, an operational check. If failure is noted, proceed as in paragraph 4.3.
- Step 7. Apply low level vibration to the test item/fixture interface. If required, include other environmental stresses.
- Step 8. Verify that the vibration exciter, fixture, and instrumentation system functions as required.
- Step 9. Apply the required vibration levels to the test item/fixture interface, as well as any other required environmental stresses.
- Step 10. Verify that vibration levels at test item/fixture interface are as specified. If the exposure duration is 1/2 hour or less accomplish this step immediately after full levels are first applied, and immediately before scheduled shut down. Otherwise, accomplish this step immediately after full levels are first applied, every half-hour thereafter, and immediately before scheduled shut down.
- Step 11. Monitor vibration levels and, if applicable, test item performance continuously through the exposure. If levels shift or a failure occurs, shut down the test in accordance with the test shut down procedure (paragraph 3.1b(10)). Determine the reason for the shift and proceed in accordance with the test interruption recovery procedure (paragraph 3.1b(11)).
- Step 12. When the required duration has been achieved, stop the vibration. Depending on the test objectives, the test plan may call for additional exposures at varied levels prior to shut down. If so, repeat steps 6 through 12 as required by the test plan before proceeding.
- Step 13. Inspect the test item, fixture, vibration exciter, and instrumentation. If failure, wear, looseness, or other anomalies are found, proceed in accordance with the test interruption recovery procedure (paragraph 3.1b(11)).
- Step 14. Verify that the instrumentation functions as required and perform an operational check of the test item. If a failure is noted, proceed as in paragraph 4.3.
- Step 15. Repeat steps 1 through 14 for each required excitation axis.

METHOD 514.5

- Step 16. Repeat steps 1 through 15 for each required vibration exposure.
- Step 17. Remove the test item from the fixture and inspect the test item, mounting hardware, packaging, etc. Refer to paragraph 4.3 if there are failures.

4.5.3 Procedure II - Loose cargo transportation.

- Step 1. Perform a visual inspection of the test item and an operational check.
- Step 2. Conduct test item modal survey, if required.
- Step 3. Place the test item(s) on the package tester within the restraining fences in accordance with paragraphs 4.1.2 and 4.4.2.
- Step 4. Install instrumentation sufficient to measure any required parameters. Ensure that the total accuracy of the instrumentation system is sufficient to meet specified accuracy requirements.
- Step 5. Operate the package tester for one-half of the prescribed duration.
- Step 6. Perform a visual inspection of the test item and an operational check. If a failure is noted, proceed as in paragraph 4.3.
- Step 7. Reorient the test item(s) and/or the fencing/impact walls in accordance with paragraph 4.4.2.
- Step 8. Operate the package tester for one-half of the prescribed duration.
- Step 9. Perform a visual inspection of the test item and an operational check. If a failure is noted, proceed as in paragraph 4.3.

4.5.4 Procedure III - Large assembly transportation.

- Step 1. Perform a visual inspection of the test item and an operational check. If a failure is noted, proceed as in paragraph 4.3.
- Step 2. Mount the test item(s) on/in the test vehicle as required in the test plan.
- Step 3. Install transducers on or near the test item sufficient to measure vibration at the test item/vehicle interface and to measure any other required parameters. Protect transducers to prevent contact with surfaces other than the mounting surface.
- Step 4. Subject the vehicle containing the test item to the specified test conditions.
- Step 5. Perform a visual inspection of the test item and an operational check. If a failure is noted, proceed as in paragraph 4.3.
- Step 6. Repeat steps 1 through 5 for additional test runs, test loads, or test vehicles as required by the test plan.

4.5.5 Procedure IV - Assembled aircraft store captive carriage and free flight.

- Step 1. With the store suspended within the test chamber and the instrumentation functional, verify that the store suspension system functions as required by measuring the suspension frequencies.
- Step 2. If required, conduct a test item modal survey.
- Step 3. Place the test item in an operational mode and verify that it functions properly.
- Step 4. Apply low level vibration to the vibration exciter/store interface(s) to ensure that the vibration exciter and instrumentation system function properly. For acceleration feedback control, use an initial input level 9 dB down from the required forward test monitor transducer spectrum. For force feedback control, use a flat force spectrum where the response at the test monitor accelerometer is at least 9 dB below the required test monitor value at all frequencies. For bending moment feedback

MIL-STD-810F
1 January 2000

control, use an initial input level that is 9 dB down from the required test monitor transducer spectrum.

- Step 5. Adjust the vibration exciter(s) such that the test monitor transducers in the excitation axis meet the test requirements. For acceleration control, identify the test monitor transducer spectrum peaks that exceed the input spectrum by 6 dB or more (frequencies may differ fore and aft). For force feedback control, identify major peaks from the force measurements to check monitor accelerometer transfer functions. For both cases, equalize the input spectra until the identified peaks equal or exceed the required test levels. The resulting input spectra should be as smooth and continuous as possible while achieving the required peak responses. (It is not necessary to fill in valleys in the test monitor transducer spectra; however, it is not acceptable to notch out the input in these valleys.) For bending moment control raise and shape the input spectrum until it matches the required spectrum (peaks and valleys).
- Step 6. When the input vibration is adjusted such that the required input response (A_1) is achieved, measure the off-axis response(s) (A_2, A_3). Verify that off-axis response levels are within requirements using the following equations. If the result obtained from the equation is greater than the value established for the equation, reduce the input vibration level until the achieved input and off-axis response levels balance the equation. Apply these equations at each peak separately. Use the first equation for testing that requires vibration application in two separate mutually perpendicular axes, and use the second equation for testing that requires vibration application in three separate mutually perpendicular axes.

$$2 = (R_1/A_1 + R_2/A_2) \text{ or } 3 = (R_1/A_1 + R_2/A_2 + R_3/A_3)$$

where;

R_i = Test requirement level in g^2/Hz or $(N-m)^2/Hz$ or $(in-lb)^2/Hz$ for $i = 1 - 3$, and

A_i = Response level in g^2/Hz or $(N-m)^2/Hz$ or $(in-lb)^2/Hz$ for $i = 1 - 3$

For example:

For testing that requires vibration application in three separate mutually perpendicular axes, and when vibration is being applied in the vertical axis, use the equation below as follows.

$$3 = (R_1/A_1 + R_2/A_2 + R_3/A_3)$$

where;

R_1 = Vertical axis test requirement level

A_1 = Vertical axis response level

R_2 = Horizontal axis test requirement level

A_2 = Horizontal axis response level

R_3 = Longitudinal axis test requirement level

A_3 = Longitudinal axis response level

For vibration being applied in the horizontal axis, use the equation below as follows.

$$3 = (R_1/A_1 + R_2/A_2 + R_3/A_3)$$

where;

R_1 = Horizontal axis test requirement level

A_1 = Horizontal axis response level

R_2 = Vertical axis test requirement level

A_2 = Vertical axis response level

R_3 = Longitudinal axis test requirement level

A_3 = Longitudinal axis response level

For vibration being applied in the longitudinal axis, use the equation below as follows.

$$3 = (R_1/A_1 + R_2/A_2 + R_3/A_3)$$

where;

R_1 = Longitudinal axis test requirement level

A_1 = Longitudinal axis response level

R_2 = Vertical axis test requirement level

A_2 = Vertical axis response level

R_3 = Horizontal axis test requirement level

A_3 = Horizontal axis response level

- Step 7. Verify that vibration levels are as specified. If the exposure duration is 1/2 hour or less, accomplish this step immediately after full levels are first applied, and immediately before scheduled shut down. Otherwise, accomplish this step immediately after full levels are first applied, every half-hour thereafter, and immediately before scheduled shut down.
- Step 8. Monitor the vibration levels and test item performance continuously through the exposure. If levels shift, performance deviates beyond allowable limits, or failure occurs, shut down the test in accordance with the test shut down procedure (paragraph 3.1b(10)). Determine the reason for the anomaly and proceed in accordance with the test interruption recovery procedure (paragraph 3.1b(11)).
- Step 9. When the required duration has been achieved, stop the vibration. Depending on the test objectives, the test plan may call for additional exposures at varied levels prior to shut down. If so, repeat steps 6 through 9 as required by the test plan before proceeding.
- Step 10. Inspect the test item, fixture, vibration exciter, and instrumentation. If failure, wear, looseness or other anomalies are found, proceed in accordance with the test interruption recovery procedure (paragraph 3.1b(11)).
- Step 11. Verify that the instrumentation functions as required and perform an operational check of the test item for comparison with data collected in paragraph 4.5.1.2. If a failure is noted, proceed as in paragraph 4.3.
- Step 12. Repeat steps 1 through 11 for each required excitation axis.
- Step 13. Repeat steps 1 through 12 for each required vibration exposure.
- Step 14. Remove the test item from the fixture and inspect the test item and mounting hardware. Refer to paragraph 4.3 if there are failures.

5. ANALYSIS OF RESULTS.

In addition to the guidance provided in Part One, paragraph 5.14, the following is provided to assist in the evaluation of the test results.

5.1 Physics of Failure.

Analyses of vibration related failures must relate the failure mechanism to the dynamics of the failed item and to the dynamic environment. It is not enough to determine that something broke due to high cycle fatigue or wear. It is necessary to relate the failure to the dynamic response of the materiel to the dynamic environment. Thus, include in failure analyses a determination of resonant mode shapes, frequencies, damping values and dynamic strain distributions in addition to the usual material properties, crack initiation locations, etc. (See Annex B, paragraph 2.5).

MIL-STD-810F
1 January 2000

5.2 Qualification Tests.

When a test is intended to show formal compliance with contract requirements the following definitions are recommended.

- a. Failure definition. "Materiel is deemed to have failed if it suffers permanent deformation or fracture; if any fixed part or assembly loosens; if any moving or movable part of an assembly becomes free or sluggish in operation; if any movable part or control shifts in setting, position or adjustment, and if test item performance does not meet specification requirements while exposed to functional levels and following endurance tests." Ensure this statement is accompanied by references to appropriate specifications, drawings, and inspection methods.
- b. Test completion. "A vibration qualification test is complete when all elements of the test item have successfully passed a complete test. When a failure occurs, stop the test, analyze the failure, and repair the test item. Continue the test until all fixes have been exposed to a complete test. Each individual element is considered qualified when it has successfully passed a complete test. Qualified elements that fail during extended tests are not considered failures and can be repaired to allow test completion."

5.3 Other Tests.

For tests other than qualification tests, prepare success and/or failure criteria and test completion criteria that reflect the purpose of the tests.

6. REFERENCE/RELATED DOCUMENTS.

- a. Methodology Investigation, Final Report of the TECOM Package Tester Characterization, AD B217688, September 1996.
- b. Test Operations Procedure (TOP) 1-1-011, Vehicle Test Facilities at Aberdeen Proving Ground, 6 July 1981; DTIC AD No. A103325.
- c. Handbook for Dynamic Data Acquisition and Analysis, IES-RP-DTE012.1, Institute of Environmental Sciences, 940 East Northwest Highway, Mount Prospect, IL 60056.
- d. International Test Operating Procedure (ITOP) 1-2-601, FR/GE/UK/US. Laboratory Vibration Schedules. 19 October 1992. DTIC AD No B169566L.
- e. International Test Operating Procedure (ITOP) 1-1-050. Development of Laboratory Vibration Test Schedules. 6 June 1997. DTIC AD No B227368.
- f. Tevelow, Frank L., The Military Logistical Transportation Vibration Environment: Its Characterization and Relevance to MIL-STD Fuse Vibration Testing. Harry Diamond Laboratories, December 83. HDL-SR-83-11.
- g. Connon, William H. (III). Methodology Investigation, Final Report, Ground Vehicle-Loose Cargo Vibration Schedules. January 1987. DTIC AD No. B1114819L.
- h. White, George O., Methodology Investigation, Final Report, Loose Cargo Testing of Unpackaged Separate Loading Projectiles. May 1990, DTIC No. B144437.
- i. Wafford, J. H. and J. F. Dreher, Aircraft Equipment Vibration Test Criteria Based on Vibration Induced by Jet and Fan Engine Exhaust Noise. Shock and Vibration Bulletin 43, Part 3, 1973, pp. 141-151.
- j. Dreher, J. F., Aircraft Equipment Random Vibration Test Criteria Based on Vibration Induced by Turbulent Air Flow Across Aircraft External Surfaces. Shock and Vibration Bulletin 43, Part 3, 1973, pp. 127-139.
- k. Hinegardner, W. D., et al., Vibration and Acoustics Measurements on the RF-4C Aircraft. Wright-Patterson AFB, OH: ASD Systems Engineering Group, 1967, TM-SEF-67-4.

- l. Bartel, H. W and J. M. McAvoy, Cavity Oscillation in Cruise Missile Carrier Aircraft. Air Force Wright Aeronautical Laboratories, June 1981. AFWAL-TR-81-3036.
- m. Tipton, A. G., Weapon Bay Cavity Noise Environments Data Correlation and Prediction for the B-1 Aircraft. Air Force Wright Aeronautical Laboratories, June 1980. AFWAL-TR-80-3050.
- n. Thomas, C. E., Flight Survey of C-130A Aircraft. March 1972. ASD-TR-62-2167. DTIC No. AD-274-904.
- o. Bolds, P. G., Flight Vibration Survey C-133 Aircraft. April 1972. ASD-TDR-62-383. DTIC No. AD-277-128.
- p. Kuhn, D. L., Analysis of the Vibration Environment for Airborne Reconnaissance Integrated Electronics System (ARIES) Installed on EP-3E Aircraft. Indianapolis: Naval Avionics Center 443, 1975. Document No. ESL-163.
- q. Kuhn, D. L. and R. M. Johnson., Evaluation of the Vibration Environment for the Doppler Ranging Information System. Indianapolis: Naval Avionics Center 443, 1982. Document No. ESL-420.
- r. Analysis of the Vibration Environment for TACAMO IV B System Installed on ED-130 Aircraft. Indianapolis: Naval Avionics Center 443, 1976. Document No. ESL-199.
- s. Kuhn, D. L., Evaluation of Flight Data for the Big Look Antenna System OE-319/APS Installed on EP-3E aircraft. Indianapolis: Naval Avionics Center 443, 1981. Document No. ESL-418.
- t. Kuhn, D. L., Analysis of Flight Data for Deepwell System Installed in EP-3E Aircraft. Indianapolis: Naval Avionics Center 443, 1975. Document No. ESL-169.
- u. Dreher, J. F., E. D. Lakin, and E. A. Tolle, Vibroacoustic Environment and Test Criteria for Aircraft Stores During Captive Flight. Shock and Vibration Bulletin 39, Supplement (1969), pp. 15-40.
- v. Dreher, J. F., Effects of Vibration and Acoustical Noise on Aircraft/Stores Compatibility. Aircraft Store Symposium Proceedings, Vol. 6, November 1969.
- w. Piersol, A. G., Vibration and Acoustic Test Criteria for Captive Flight of Externally Carried Stores, December 1971. AFFDL-TR-71-158. DTIC No. AD-893-005L.
- x. Frost, W. G., P. B. Tucker, and G. R. Waymon, Captive Carriage Vibration of Air-to-Air Missiles on Fighter Aircraft. Journal of Environmental Sciences, 21:15, (September/October 1978), pp. 11-15.
- y. Mechanical Vibrations; Den Hartog, J. P., Fourth Edition, McGraw-Hill Book Company. 1956.
- z. A Modern Course in Aeroelasticity. Dowell, E. H., et al, Second Edition, Kluwer Academic Publisher, 1989.
- aa. Shock and Vibration Handbook. Edited by Harris, Cyril M. and Charles E. Crede; McGraw-Hill Book Company.
- bb. Bendat, Julius S., and Piersol, Allan G., Engineering Applications of Correlation and Spectral Analysis, 2nd Edition, John Wiley & Sons, Inc., New York, 1993.
- cc. Allemang, Randall J. and David L. Brown, Experimental Modal Analysis and Dynamic Component Synthesis - Measurement Techniques for Experimental Modal Analysis. Vol. II. December 1987. AFWAL-TR-87-3069.
- dd. Allemang, Randall J. and David L. Brown, Experimental Modal Analysis and Dynamic Component Synthesis - Modal Parameter Estimation. Vol. III. December 1987. AFWAL-TR-87-3069.
- ee. Allemang, Randall J. and David L. Brown, Experimental Modal Analysis and Dynamic Component Synthesis - System Modeling Techniques. Vol. VI. December 1987. AFWAL-TR-87-3069.
- ff. Airplane Aerodynamics, Dommasch, Daniel O, Sidney S. Sherby and Thomas F. Connolly, Pitman Publishing Corporation, 1958.

MIL-STD-810F
1 January 2000

- gg. U.S. Standard Atmosphere, 1962.
- hh. MIL-HDBK-167, Mechanical Vibrations of Shipboard Equipment (Type I – Environmental and Type II – Internally Excited).
- ii. Mission Environmental Requirements Integration Technology (MERIT), Final Report (draft), 15 September 1996, McDonald Douglas Aerospace

ANNEX A

TAILORING GUIDANCE FOR VIBRATION EXPOSURE DEFINITION

1. SCOPE.

1.1 Purpose.

This Annex provides information intended to be useful in determining the vibration levels and durations of environmental life cycle events and in defining the tests necessary to develop materiel to operate in and survive these environments.

1.2 Application.

It is highly recommended that actual environments be measured and materiel life cycle durations be used to develop materiel design and test criteria whenever possible. Existing databases can sometimes be used in lieu of measurements. A preliminary environmental life cycle based on data provided herein can be useful as a planning tool. A preliminary life cycle definition can be used to concentrate limited resources on those vibration exposures most significant to the materiel. Guidance for setting design and test exposure values is given below with descriptions of vibration environments of many typical life cycle events. Suggested alternate criteria (levels and durations) or other guidance is recommended for those cases where measured data defining the actual environments are not available. Table 514.5-I contains an outline of the following section with references to the paragraph numbers.

2. VIBRATION ENVIRONMENTS.

2.1 Manufacture/Maintenance.

The following areas are not usually considered as part of the environmental life cycle. However these activities may result in vibratory fatigue damage to the materiel. Evaluate these environments and, where significant, include them in design and as preconditioning to environmental tests.

2.1.1 Category 1 - Manufacturing/Maintenance processes.

All materiel will experience some vibration during manufacture and maintenance.

- a. Manufacture. If manufacturing processes are identical for all items (including test items), this exposure is common and additional testing is not required. However, evaluate this environment and include it in design calculations when significant. When different serial number items (lots) experience significant differences in vibration exposure during manufacture, select vibration test specimens from those items that experience the maximum vibration exposure.
- b. Maintenance. Evaluate this environment and include it in design and test exposures when significant.
- c. Exposure levels. Measure exposure levels. Where levels vary between serial number items, use the maximum values.
- d. Exposure durations. Determine exposure durations from the manufacturing and/or maintenance processes. Where durations vary between serial number items, use the maximum values.

MIL-STD-810F
1 January 2000
ANNEX A

2.1.2 Category 2 - Shipping and handling.

Parts, subassemblies, and materiel are subject to vibration of handling and transportation within and between manufacturing and maintenance facilities. If handling and transportation are identical for all items (including test articles), this exposure is common and testing is not required. However, evaluate this environment and include it in design calculations when significant. When there are significant differences between exposures to different serial number items (lots), select vibration test articles from those items that experience the maximum vibration exposure.

- a. Exposure levels. Where transportation is by normal commercial means, use the applicable guidance of Annex A, paragraph 2.2. For other conditions, measure exposure levels.
- b. Exposure durations. Where transportation is by normal commercial means, use the applicable guidance of Annex A, paragraph 2.2. Determine exposure durations from manufacturing and maintenance planning.

2.1.3 Category 3 - Environmental Stress Screen (ESS).

Parts, subassemblies, and materiel are often subject to ESS vibration exposures during manufacturing and maintenance. While exposure levels are identical for each like item, exposure times are not. Items can be subjected to multiple cycles of ESS prior to production acceptance. Further, exposures are often significant with respect to vibratory fatigue. Include maximum allowable exposures in design calculations and as environmental test preconditioning.

- a. Exposure levels. Use specified exposure levels for part, subassembly, and materiel ESS.
- b. Exposure durations. Use the maximum allowable production and maintenance exposure durations for part, subassembly, and materiel ESS.

2.2 Transportation.

- a. Test item configuration. In all transportation exposures, configure the test item (packaged or not) as appropriate for the specific transportation phase. The following criteria are defined as inputs to packaged (or transportation configured) materiel. Use test items that are real materiel in real packaging. Making a vibration measurement on a simulated (dummy) item and comparing this to other vibration exposures of the materiel life cycle is generally not adequate. See paragraph 1.3.b in the front part of this method, and Annex B, paragraph 2.4.
- b. Configuration variation with transportation phase. Packaging is sometimes reconfigured for different transportation phases. For example, shipping containers may have low frequency shock isolation systems to protect against dropping and bumping while loading and unloading. This low frequency system may be bypassed by blocking or bracing when the container is loaded in the cargo area of the transport vehicle. The guidance provided below is for the vibration portion of the environment while being transported by various vehicles. See method 516.5 for guidance on shock environments.
- c. Shock or vibration isolation. Materiel as packaged for shipment should not have very low resonant frequencies (see Annex B, paragraph 2.4.2). Otherwise, damage due to impacting of fixed and suspended elements or over-extension of suspension elements is likely. Packaging/configuring for transport should include blocking softly suspended internal elements to prevent low frequency relative motion between suspended elements and surrounding structures. The minimum suspension frequency should be two times the frequency of any low frequency spike or hump in the input spectra. In addition, the minimum suspension frequency of materiel packaged for transport on fixed wing aircraft should be 20 Hz (see Annex A, paragraphs 2.2.4 and 2.2.5).
- d. Materiel orientation. When packaged materiel orientation is fixed relative to the transportation vehicle, vibration exposures should be related to vehicle orientation (e.g., vertical, longitudinal, transverse). When orientation within the vehicle can vary, vibration exposures should be derived from envelopes of possible orientations (e.g., longitudinal and transverse combined, vertical).

METHOD 514.5

514.5A-2

Note: Annex A, paragraph 2.2.3, below, for truck/trailer large assembly cargo can be tailored to any cargo size or tiedown configuration when high accuracy of ground vehicle transport environmental measurement or test is required.

2.2.1 Category 4 - Truck/trailer/tracked - restrained cargo.

These transportation environments are characterized by broadband vibration resulting from the interaction of vehicle suspension and structures with road and surface discontinuities. Representative conditions experienced on moving materiel from point of manufacture to end-use are depicted in Part One, figure 4-2. This environment may be divided into two phases, truck transportation over U.S. highways and mission/field transportation. Mission/field transportation is further broken down into two-wheeled trailer/wheeled vehicles and tracked vehicle categories.

- a. Truck transportation over U. S. highways. This involves movement from the manufacturer's plant to any continental United States storage or user installation. (Data are available for U.S. roads but not for roads in other countries.) This movement is usually accomplished by large truck and/or tractor-trailer combination. Mileage for this transportation generally ranges from 3200 to 6400 kilometers (2000 to 4000 miles) over improved or paved highways.
- b. Mission/field transportation. This involves movement of materiel as cargo where the platform may be two-wheeled trailers, 2-1/2 to 10 ton trucks, semi-trailers, and/or tracked vehicles. Typical distances for this phase are 500 to 800 kilometers (300 to 500 miles). Road conditions for mission/field support differ from the common carrier in that, in addition to the paved highway, the vehicles will traverse unimproved roads and unprepared terrain (off-the-road) under combat conditions.
- c. Exposure levels. Whenever possible, measure vibration on the transport vehicles using the road conditions (surfaces, speeds, and maneuvers) of the materiel's Life Cycle Environment Profile. Include realistic load configurations (approximately 75% of the vehicle load capacity by weight). Use these data to develop exposure levels (see examples in ITOP 1-2-601 (reference d)). Alternatively, derive exposure levels as discussed below.
 - (1) Truck transportation over U. S. highways. Derive exposure levels from Annex C, figure 514.5C-1. These figures are based upon data measured at the cargo floor of seven different configurations of trucks and semitrailer combinations. Both conventional suspensions and air-cushioned suspensions are represented. The data were collected from typical interstate highways with rough portions as part of the database.
 - (2) Two-wheeled trailer and wheeled vehicles. Exposures are shown in Annex C, figures 514.5C-2 and 514.5C-3. Both trucks and two-wheeled trailers are utilized between the Forward Supply Point (FSP) and at the Using Unit (USU). Trailer vibration levels are significantly higher; use these to represent the wheeled vehicle environment. However, when materiel is too large for the two-wheeled trailer, use the composite wheeled levels.
 - (3) Tracked vehicles. A representative tracked vehicle spectrum shape is given in Annex C, figure 514.5C-4. Note that this figure is based on sweeping across the narrow band spikes as discussed in reference f that also contains detailed criteria for some tracked vehicles. Testing to this requirement will require a narrow band random-on-random vibration exciter control strategy.
- d. Exposure durations. Base durations on the materiel Life Cycle Environment Profile. Annex C, table 514.5C-I shows the typical field/mission transportation scenario with the most typical vehicles.
 - (1) Truck transportation over U. S. highways. The exposure duration for common carrier/truck is 60 minutes per 1609 kilometers (1000 miles) of road travel (per axis). (See ITOP 1-1-050 (reference e) for guidance.)
 - (2) Two-wheeled trailer and wheeled vehicles. The exposure duration for two-wheeled trailer is 32 minutes per 51.5 kilometers (32 miles) traveled (per axis) and the exposure duration for composite wheeled vehicle is 40 minutes per 804.6 kilometers (500 miles) traveled (per axis).

MIL-STD-810F
1 January 2000
ANNEX A

- (3) Tracked vehicles. Use environmental life cycle durations. See reference f for further guidance.

2.2.2 Category 5 - Truck/trailer/tracked - loose cargo.

The cargo has freedom to bounce, scuff and collide with other cargo and with the sides of the vehicle. The loose cargo environment includes conditions experienced by cargo transported in a vehicle traversing irregular surfaces. This test replicates the repetitive random shock environment incurred by cargo transported under these conditions. This test does not address general cargo deck vibration or individual shocks or impacts inflicted during handling or accidents.

- a. Exposure levels. This environment is a function of package geometry and inertial properties, vehicle geometry, and the complex vibratory motion of the vehicle cargo bed. No database exists for input vibration to simulate this environment. However, the test discussed below will provide a generally conservative simulation of the environment.
- (1) Two methodology studies (references g and h) determined that a standard package tester (300 rpm, circular synchronous mode) (Annex C, figure 514.5C-5) provides a reasonable simulation of the loose cargo transportation environment. The movement of the package tester bed is a 2.54 cm (1.0 inch) diameter orbital path at 5 Hz (each point on the bed moves in a circular path in a plane perpendicular to the horizontal plane). The test item is allowed to collide with established test setup restraints.
 - (2) This test is not tailorable and cannot be directly interpreted in terms of materiel design requirements.
- b. Exposure durations. A duration of 20 minutes represents 240 km (150 miles) of transportation (encompassing truck, two-wheeled trailer, and tracked vehicle), over the various road profiles found in the transport scenario from the Corps storage area to a Using Unit (see Annex C, table 514.5C-I). Scenario times in the materiel Life Cycle Environment Profile should be ratioed to define exposure times.

2.2.3 Category 6 - Truck/trailer/tracked - large assembly cargo.

For large materiel, it is necessary to recognize that the materiel and the transport vehicle vibrate as a flexible system (see Annex B, paragraph 2.4). In such cases, transportation conditions may be simulated using the actual transport vehicle as the vibration exciter. The test assemblage may consist of materiel mounted in a truck, trailer, tracked vehicle, or materiel mounted in a shelter that is then mounted on a truck, trailer, or dolly set. Ensure the materiel is mounted and secured on the transport vehicle(s) that is used during actual transport. Provide instrumentation to measure vertical vibration of the materiel mounts, cargo floor, or shelter floor. Provide additional instrumentation as needed to determine the vibration of the materiel and critical subassemblies.

Note: This procedure is suitable for measuring or testing for the transportation or ground mobile environment of materiel of any size or weight. For smaller cargo loads, the assemblage should be either the specific design cargo load or the most critical cargo load(s) for the transport vehicle as appropriate.

- a. Exposure levels. The assemblage should be in its deployment configuration and mounted on the vehicle for which it was designed. If the assemblage is to be contained in a shelter, it should be installed within the shelter in the deployment configuration. The exposure consists of traversing the transport vehicle over a prepared test course. The test course and vehicle speeds should represent the transportation terrain/road conditions of the Life Cycle Environment Profile. Note that transport vehicle speeds may be limited either by the vehicle's safe operating speed over a specific course profile or by the speed limit set for the specific course. An example based on test surfaces available at the U.S. Army Aberdeen Test Center (reference b) is as follows. Drive the test vehicle over each of the following test surfaces. Operate at the specified speeds unless these exceed safe driving conditions. In this case, define and coordinate maximum safe operating speeds with the authority responsible for the environmental requirements.
- (1) Coarse washboard (150 mm waves 2 m apart) 8 km/hr

METHOD 514.5

- | | |
|--|----------|
| (2) Belgian block | 24 km/hr |
| (3) Radial washboard (50 mm to 100 mm waves) | 24 km/hr |
| (4) Two inch washboard (50 mm) | 16 km/hr |
| (5) Three inch spaces bump (75 mm) | 32 km/hr |
- b. Exposure durations. Ensure the durations (distances over) of each test course segment/speed combination are in accordance with the scenario(s) of the Life Cycle Environment Profile.

2.2.4 Category 7 - Aircraft - jet.

Cargo vibration environments on jet aircraft are broadband random in nature. The maximum vibrations are usually engine exhaust noise generated and occur during takeoff. Levels drop off rapidly after takeoff to lower level cruise levels that are boundary layer noise generated. These sources are discussed in Annex A, paragraph 2.3.1.

- a. Low frequency vibration. Vibration criteria typically begins at 15 Hz. At frequencies below 15 Hz, it is assumed that the cargo does not respond dynamically (see Annex B, paragraph 2.4). Airframe low frequency vibration (gust response, landing impact, maneuvers, etc.) is experienced as steady inertial loads (acceleration). That part of the environment is included in method 513.5.
- b. Large cargo items. Cargo items that are large relative to the airframe in dimensions and/or mass may interact with aircraft structural dynamics (see Annex B, paragraph 2.4). This is particularly true if the materiel has natural frequencies below 20 Hz. This interaction may have serious consequences with regard to aircraft loads and flutter. Evaluate materiel that fits this description by the aircraft structural engineers prior to carriage. Contact the System Program Office responsible for the aircraft type for this evaluation.
- c. Exposure levels.
- (1) Vibration qualification criteria for most jet cargo airplanes are available through the System Program Office responsible for the aircraft type. These criteria are intended to qualify equipment for permanent installation on the airplanes and are conservative for cargo. However, function criteria for equipment located in the cargo deck zones can be used for cargo if necessary. The guidance of Annex A, paragraph 2.3.1 can also be used to generate conservative criteria for specific airplanes and cargo.
 - (2) Annex C, figure 514.5C-6 shows the cargo compartment zone functional qualification levels of the C-5, C/KC-135, C-141, E-3, KC-10, and T-43 aircraft. Also, shown on the figure is a curve labeled "General Exposure." These are the recommended criteria for jet aircraft cargo. This curve is based on the worst case zone requirements of the most common military jet transports so that even though it does not envelope all peaks in the various spectra, it should still be mildly conservative for cargo. Also, since it does not allow the valleys in the individual spectra, it should cover other jet transports with different frequency characteristics. The envelope represents take-off, the worst case for cargo. Vibration during other flight conditions is substantially less.
- d. Exposure durations. When Annex C, figure 514.5C-6 is used, select a duration of one minute per takeoff. Determine the number of takeoffs from the Life Cycle Environment Profile. Otherwise, take durations from the Life Cycle Environment Profile.

2.2.5 Category 8 - Aircraft - propeller.

Cargo vibration environments on propeller aircraft are dominated by relatively high amplitude, approximately sinusoidal spikes at propeller passage frequency and harmonics. Because of engine speed variations, the frequencies of the spikes vary over a bandwidth. There is wide band vibration at lower levels across the spectra. This wide band vibration is primarily due to boundary layer flow over the aircraft. These sources are discussed in Annex A, paragraph 2.3.2.

MIL-STD-810F
1 January 2000
ANNEX A

- a. Low frequency vibration. Vibration criteria typically begin at 15 Hz. At frequencies below 15 Hz it is assumed that the cargo does not respond dynamically (see Annex B, paragraph 2.4). Airframe low frequency vibration (gust response, landing impact, maneuvers, etc.) are experienced as steady inertial loads (acceleration). That part of the environment is included in method 513.
- b. Large cargo items. Cargo items that are large relative to the airframe in dimensions and/or mass may interact with aircraft structural dynamics (see Annex B, paragraph 2.4). This is particularly true if the materiel has natural frequencies below 20 Hz. This interaction may have serious consequences with regard to aircraft loads and flutter. Materiel that fits this description must be evaluated by aircraft structural engineers prior to carriage. Contact the System Program Office responsible for the aircraft type for this evaluation.
- c. Exposure levels. Contact the System Program Office responsible for the aircraft for vibration criteria. If no criteria are available, measurements of cargo deck vibration in the aircraft are recommended. As a last resort the guidance of Annex A, paragraph 2.3.2 can be used.
- d. Exposure durations. Take durations from the Life Cycle Environment Profile.

2.2.6 Category 9 - Aircraft - helicopter.

- a. Environment characterization. Vibration of cargo carried in helicopters is characterized by a continuous wideband, low-level background with strong narrowband peaks superimposed. This environment is a combination of many sinusoidal or near sinusoidal components due to main and tail rotors, rotating machinery and low-level random components due to aerodynamic flow. These sources are discussed in Annex A, paragraph 2.3.3.
- b. Sling loads. Cargo carried as sling loads below a helicopter is normally subjected to low level random vibration due to turbulent flow around the cargo with narrow band peaks due to helicopter main rotor blade passage. In addition, there will be low frequency (primarily vertical) motions due to the sling suspension modes (similar to vibration isolator modes, see Annex B, paragraph 2.4.2). Choose slings based on sling stiffness and suspended mass such that suspension frequencies (f_s) do not coincide with helicopter main rotor forcing frequencies (f_j). Ensure suspension frequencies are not within a factor of two of forcing frequencies ($f_s < f_j / 2$ or $f_s > 2 f_j$). Determine main rotor forcing frequencies (shaft rotation frequency, blade passage frequency, and harmonics) for several helicopters from Annex C, table 514.5C-IV. When inappropriate combinations of cargo and slings are used, violent vibration can occur. The cargo is likely to be dropped to protect the helicopter.
- c. Exposure levels.
 - (1) Helicopter internal cargo vibration is a complex function of location within the helicopter cargo bay and the interaction of the cargo mass and stiffness with the helicopter structure. Measurements of the vibration of the cargo in the specific helicopter are necessary to determine vibration with any accuracy. Approximate criteria may be derived from Annex A, paragraph 2.3.3. A revised version of reference f, scheduled for 1998 release, contains tailored criteria for specific helicopters.
 - (2) There is no current source of data to define slung cargo vibration levels. However, these levels should be low and should not be a significant factor in design of materiel that has a reasonable degree of ruggedness. Materiel that has been designed for vibration levels and durations equal to or exceeding the suggested minimum integrity test of Annex A, paragraph 2.4.1 should not be affected by this environment.
 - (3) Exposure durations. Take durations from the Life Cycle Environment Profile or from reference f.

2.2.7 Category 10 - Ship - surface ship.

The vibration environment of cargo carried in ships is fundamentally the same as for materiel installed on ships. See Annex A, paragraph 2.3.10.

METHOD 514.5

514.5A-6

- a. Exposure levels. See Annex A, paragraph 2.3.10.
- b. Exposure durations. See Annex A, paragraph 2.3.10.

2.2.8 Category 11 - Railroad - train.

Cargo vibration levels for rail transport are generally low in level and moderately wideband. Vertical axis vibration is typically more severe than lateral and longitudinal. See ITOP 1-1-050 (reference e).

- a. Exposure levels. Annex C, figure 514.5C-7 provides a general definition of railcar vibration. The levels are such that this environment will not significantly affect materiel or packaging design in most cases. In those cases where the levels of Annex C, figure 514.5C-7 are significant to materiel, take measurements to determine the actual environments.
- b. Exposure durations. Take durations from the Life Cycle Environment Profile.

2.3 Operational Service.

This section applies to materiel installed in a vehicle, aircraft store, turbine engine, or carried by personnel. Such materiel may be permanently installed or removable.

2.3.1 Category 12 - Fixed wing aircraft - jet aircraft.

The vibration environment for materiel installed in jet aircraft (except engine-mounted, see Annex A, paragraph 2.3.11 and gunfire-induced, see method 519.5) stems from four principal mechanisms. These are (1) engine noise impinging on aircraft structures; (2) turbulent aerodynamic flow over external aircraft structures, (3) turbulent aerodynamic flow and acoustic resonance phenomena within cavities open to the external airflow, particularly open weapon bays, and (4) airframe structural motions due to maneuvers, aerodynamic buffet, landing, taxi, etc. Vibration can also be produced by installed materiel items. These vibrations are generally important only locally at or near the source and may not be significant even in that local area.

- a. Airframe structural response. Airframe structural motions are the responses of flexible airframe structures to transient events. Examples of such events are landing impact, arrested landings, catapult, rebound of wings and pylons when heavy stores are ejected, and separated flow or shed vortex excitation of flight surfaces during maneuvers. Catapult take-off and arrested landing also result in structural motions. These are included in method 516.5 as transient vibrations. Airframe structural motions are most important for the outer regions of flexible structures (i.e., outer 1/2 of wings, empennage, pylons, etc.). These vibrations are characteristic of the particular airframe involved and must be evaluated through measured data. In other areas of the airframe (fuselage, inboard wing, etc.) these vibrations are relatively mild and are generally covered by the fallback criteria described below or by minimum integrity criteria (Annex A, paragraph 2.4.1).
- b. Jet noise and aerodynamically induced vibration. Jet noise induced vibration is usually dominant in vehicles that operate at lower dynamic pressures, i.e., limited to subsonic speeds at lower altitudes and transonic speeds at high altitudes (reference i). Aerodynamically induced vibration usually predominates in vehicles that operate at transonic speeds at lower altitudes or supersonic speeds at any altitude (references j and k).
- c. Cavity noise induced vibration. Where there are openings in the aircraft skin with airflow across the opening, the corresponding cavity within the aircraft is subject to very high levels of aerodynamic and acoustic fluctuating pressures. This is because of general flow disruption and, more importantly, to a phenomenon known as cavity resonance. The fluctuating pressures can be crudely predicted analytically (see references l and m) and somewhat more accurately measured in wind tunnel measurements. Flight test measurement is the only accurate method available to determine these pressures. Further, given the pressures, it is very difficult to predict the resulting vibration and no simple method is available. This

MIL-STD-810F
1 January 2000
ANNEX A

vibration should be measured. These vibrations are likely to be important in the local areas surrounding small cavities such as flare launchers, cooling air exhaust openings, etc. With large cavities (particularly weapons bays), the resulting vibration is likely to be a major element of the overall aircraft environment. Method 515.5 contains an acoustic test simulating this environment. That procedure may be used for materiel located inside the cavity but it is not suitable for simulating the vibration environments for areas near the cavity. Where cavities remain open continuously, the vibration is continuous. When doors or covers open, there will be a transient vibration. As the doors remain open, there is a steady state vibration, followed by another transient vibration as the doors close. When doors open and close quickly, the entire event can sometimes be characterized as a single transient vibration.

- d. Materiel induced vibration. In addition, installed materiel can produce significant vibration. Any materiel that involves mechanical motion may produce vibration. This is particularly true of those that have rotating elements such as motors, pumps, and gearboxes. The vibration output of installed materiel varies widely and is highly dependent on the mounting as well as the characteristics of the materiel. There is no basis for predicting local environments due to materiel. Materiel items must be evaluated individually. General aircraft environments as discussed above can generally be expected to cover the contribution of installed materiel.
- e. Exposure levels. Vibration criteria in the form of qualification test levels (see Annex B, paragraph 2.1.2) have been established for most airplanes developed for the military. Obtain these criteria through the program office responsible for the particular aircraft. This is the recommended basis for developing exposure levels. In cases where satisfactory criteria are not available, measured data may be available through the aircraft program office. Otherwise, measurements of actual vibrations are recommended.
 - (1) As a last resort, the guidance of Annex C, table 514.5C-III and figure 514.5C-8 may be used to develop levels. Define both jet noise induced and aerodynamic noise induced levels for each flight condition of interest. The level for that flight condition is the envelope of the two.
 - (2) This applies to materiel that is small (light) relative to the structure that supports it. As materiel gets heavier, dynamic interaction with supporting structures increases. For typical full-scale manned aircraft, this effect is usually ignored for materiel weighing less than 36 kg (80 lb). A simple mass loading factor is included in Annex C, table 514.5C-III for heavier materiel. However, evaluate the installation of materiel weighing more than roughly 72 kg (160 lb.) for dynamic interaction. (See Annex B, paragraph 2.4.)
 - (3) Materiel mounted on vibration isolators (shock mounts) is dynamically uncoupled from the support structure. Unless it is very large (heavy) relative to the support structure (see Annex B, paragraph 2.4.2), its influence on vibration of the support structure will be minimal and the mass loading factor discussed above does not apply. Use the exposure levels discussed above as input to the vibration isolators.
- f. Exposure durations. Take durations from the Life Cycle Environment Profile.

2.3.2 Category 13 - Fixed wing aircraft - propeller aircraft.

The vibration environment for materiel installed in propeller aircraft (except engine-mounted, see Annex A paragraph 2.3.11, and gunfire induced, see method 519) is primarily propeller induced. The vibration frequency spectra consists of a broadband background with superimposed narrow band spikes (see references n through t). The background spectrum results from various random sources (see Annex A, paragraph 2.3.1) combined with many lower level periodic components due to the rotating elements (engines, gearboxes, shafts, etc.) associated with turboprops. The spikes are produced by the passage of pressure fields rotating with the propeller blades. These occur in relatively narrow bands centered on the propeller passage frequency (number of blades multiplied by the propeller rpm) and harmonics.

- a. Constant propeller speed. Most current propeller aircraft are constant-speed machines. This means that rpm is held constant and power changes are made through fuel flow changes and variable-pitch blades,

METHOD 514.5

514.5A-8

vanes, and propellers. These machines produce the fixed frequency spikes of Annex C, figure 514.5C-9. These spikes have a bandwidth because there is minor rpm drift, the vibration is not pure sinusoidal (Annex B, paragraph 2.3.3), and to account for materiel resonant frequency differences as modeled or tested and as manufactured and installed on the aircraft.

- b. Varying propeller speed. When propeller speed varies during operation, a spectrum or set of spectra similar to Annex C, figure 514.5C-9 is required to define vibration levels. The spikes on these spectra would have bandwidths encompassing the propeller speed variations of operation. Separate spectra may be required to describe individual mission segments.
- c. Source dwell testing. These vibration environments can be approximated in the laboratory by the source dwell test described in Annex B, paragraph 2.3.3. Vibration problems in this type of environment are typically associated with the coincidence of materiel vibration modes and excitation spikes. Intelligent designs use notches between spikes as safe regions for materiel vibration modes. It is particularly important to assure that vibration isolation frequencies do not coincide with spike frequencies. Source dwell tests minimize the likelihood that materiel will be overstressed at non-representative conditions, and ensure reasonable design provisions will not be subverted.
- d. Exposure levels. Whenever possible, use flight vibration measurements to develop vibration criteria. In the absence of flight measurements, the levels of Annex C, table 514.5C-II can be used with the spectra of Annex C, figure 514.5C-9. These levels are based on C-130 and P-3 aircraft measurements (references p through t) and are fairly representative of the environments of these aircraft. The decline of spike acceleration spectral density with frequency is based on data analyzed in a spectral density format.
- e. Exposure durations. Take durations from the Life Cycle Environment Profile.

2.3.3 Category 14 - Rotary wing aircraft - helicopter.

Helicopter vibration (for engine-mounted materiel, see Annex A, paragraph 2.3.11, and for gunfire induced vibration, see method 519.5) is characterized by dominant peaks superimposed on a broadband background, as depicted in Annex C, figure 514.5C-10. The peaks are sinusoids produced by the major rotating components (main rotor, tail rotor, engine, gearboxes, shafting, etc.). The peaks occur at the rotation speed (frequency) of each component (i. e., 1P for main rotor, 1T for tail rotor, and 1S where S designates a locally predominate rotating element) and harmonics of these speeds (e. g., 2P, 3P, 4P). The broadband background is a mixture of lower amplitude sinusoids and random vibrations due to sources such as aerodynamic flow noise (see Annex A, paragraph 2.3.1). Vibration levels and spectrum shapes vary widely between helicopter types and throughout each helicopter, depending on strength and location of sources and the geometry and stiffness of the structure. Thus, the need for measured data is acute.

- a. Broadband background. The broadband background is expressed as random vibration for design and test purposes as a matter of expediency. The definition of and application to design and test of all lower level sinusoidal and random components is not practical.
- b. Dominant sinusoids. The dominant sinusoids are generated by rotating components of the helicopter, primarily the main rotor(s), but also tail rotor, engine(s), drive shafts, and gear meshing. The normal operating speeds of these components are generally constant, varying less than five percent. However, recent designs have taken advantage of variable rotor speed control that generates a pseudo steady state rotor speed at values between 95 and 110 per cent of the nominal rotor speed. This complicates the materiel design and test process since all rotating component speeds, pseudo or otherwise, should be accounted for.
- c. Variable rotor speeds. Variable speed helicopters are also possible; in this case they also account for the full range of rotation speeds. A range of 0.975 times minimum speed to 1.025 times maximum speed is recommended.
- d. Design practice. An obvious requirement for helicopter materiel design is to avoid a match or near match between materiel resonant frequencies and the dominant sinusoids. A minimum clearance between

MIL-STD-810F
1 January 2000
ANNEX A

operating speed and resonant frequency of at least five per cent is recommended. It is important to note that helicopter frequencies and amplitudes are unique for each helicopter type and, to some degree, each model of a given type.

e. Exposure levels.

(1) For reasons stated above, the exposure levels for materiel installed in helicopters should be derived from field measurement (a revised version of reference f due for release in 1998 contains criteria for specific helicopters). When measured data are not available, levels can be derived from Annex C, figures 514.5C-10 and 514.5C-11, and table 514.5C-IV. These levels are intended to envelope potential worst-case environments. They do not represent environments under which vibration sensitive materiel should be expected to perform to specification. However, the materiel is expected to survive undamaged and to function to specification at the completion of the test. Materiel costs are often strongly influenced by the performance required in a vibration environment. Consequently, field measurement based vibration criteria can be very important.

(2) To determine levels, divide the aircraft into zones as shown in Annex C, figure 514.5C-11. Use the source frequencies of the main rotor in determining the values of A₁, A₂, A₃, and A₄ (Annex C, table 514.5C-IV) for all materiel locations except those defined below. For materiel located in the horizontal projection of the tail rotor disc, use the source frequencies of the tail rotor. In addition, ensure criteria for materiel located in an overlap of main and tail rotor zones includes both sets of frequencies. Fundamental main and tail rotor source frequencies of several helicopters are given in Annex C, table 514.5C-IV. For materiel located on or in close proximity to drive train components such as gearboxes and drive shafts, use the source frequencies of that drive train component (i.e., gear mesh frequencies, shaft rotational speeds). Determine these from the drive train data for the particular helicopter.

f. Exposure durations. When measured data are used to establish exposure levels, take durations from the Life Cycle Environment Profile. When levels are derived from Annex C, figures 514.5C-10 and 514.5C-11, and table 514.5C-IV, use a duration of four (4) hours in each of three (3) orthogonal axes for a total test time of twelve (12) hours. This represents a 2600-hour operational life. The fatigue relationship shown below may be used to trade test time for exposure level. Make the calculation separately for each sinusoid and each segment of the broadband background.

$$t_f = 4.0 (A_D / A_T)^M$$

where:

t_f = actual test time per axis

A_D = default test amplitude

A_T = actual test amplitude

M = 6 (materiel exponent for sinusoidal vibration, see Annex B, paragraph 2.2)

2.3.4 Category 15 – Aircraft stores – assembled, jet aircraft.

Assembled jet aircraft stores may encounter three distinct vibration environments; external captive carriage, internal captive carriage, and free flight.

Note: High frequency vibration (beginning at or below 1000 Hz) cannot be practically transmitted to a store mechanically. Combine store vibration and acoustic testing (method 523.2). These test excitations in combination produce a much more realistic test.

a. Captive flight – external carriage. Vibration (for gunfire induced vibration see method 519.5) experienced by a store carried externally on a jet aircraft arises primarily from four sources:

- (1) Engine noise is produced by turbulence in the boundary of the jet exhaust plume. This turbulence is maximum at initiation of takeoff when the velocity difference between the jet and ambient air is maximum. This source is generally of primary importance when the store is carried on an aircraft that uses pure jet or very low bypass engines since these engines have the highest exhaust velocities. Further, it is important at higher frequencies because sources discussed below dominate at lower frequencies (references u, v, and w).
- (2) In-flight store vibration is primarily caused by aerodynamic turbulence distributed over the surface of the store.
 - (a) In single carriage, excitation is relatively independent of the carrying aircraft and mounting location on the aircraft. Local flow disturbances such as pylon wakes will vary considerably between aircraft and between store stations on a given aircraft. In general, these do not greatly effect overall store vibration. But, they may severely effect local structures such as tail fins that, in turn, may increase levels of store vibration. See Annex A, paragraph 2.4.2 for guidance on local flow effects. When stores are carried close together, the turbulence field around each is increased. A store carried behind another store is exposed to the turbulence generated by the forward store.
 - (b) An extensive program of measurement and analysis was accomplished to characterize this environment (references u, v, and w). Vibratory excitation is influenced by store configuration, structural configuration, mass density, and flight dynamic pressure. The high frequency portion of the resulting vibration is best represented by a combination of mechanical vibration and the acoustic noise exposures of method 523.2. The low and medium frequency portion of this environment is better simulated by mechanical excitation. The studies mentioned above resulted in a method to accomplish this defining the response vibration of the store rather than specifying input vibration. Note that this method also includes low frequency vibration transmitted from the carrying aircraft (see below).
- (3) Vibrations of the carrying aircraft are transmitted to the store through the attaching structures. The total vibrating system (aircraft, pylon, bomb rack, and store) is a low frequency system. That is, the lowest natural frequency of the system is typically below 20 Hertz and the store is isolated from high frequency aircraft vibration. Depending on the particular circumstances, these vibrations are often best represented as transient vibration (see Annex B, paragraph 2.3.4).
 - (a) The low frequency vibration of the airframe transmitted to the store is not separable in the general case from the low frequency turbulence generated vibration. This vibration is accounted for by the method discussed under "Aerodynamic turbulence" above.
 - (b) Flight test measurements on the F-15 with various external stores, (reference x) have shown intense, very low frequency vibrations associated with aircraft buffet during high angle of attack maneuvers. Other aircraft, such as F-14, F-16, and F-18, or next generation fighters, have the potential to produce intense buffet vibrations during maneuvers.
 - (c) The F-15 buffet maneuver envelope is roughly bounded by speeds of 0.7 to 1.0 Mach and altitudes of approximately 3 to 10.7 kilometers (10,000 to 35,000 ft). Flight test measurements have shown the maximum F-15 buffet vibration to occur in the flight regime of 0.8 to 0.9 Mach, 4.6 to 7.6 km (15,000 to 25,000 ft) altitude, 8° to 12° angle of attack, and dynamic pressure less than 26.3 kN/m² (550 lb/ft²). Similar measurements on F/A-18 have shown the maximum buffet maneuver vibration to occur in the regime of 0.85 to 0.95 Mach, 1.5 to 4.6 km (5,000 to 15,000 ft.), 8° to 10° angle of attack, and dynamic pressure less than 33.5 kN/m² (700 lb/ft²). Although the vibration levels during high-performance maneuvers are very intense, they generally do not last for more than 10 seconds, reaching maximum in less than a second and deteriorating in 5 to 10 seconds. Typically F-15 external stores will experience 30 seconds of maneuver buffet vibration for each hour of captive-carriage flight.

MIL-STD-810F
1 January 2000
ANNEX A

- (d) Buffet vibration is typically concentrated between 10 and 50 Hz. Vibration response of the store is dominated by store structural resonances. Store loads that occur at frequencies below the lowest store natural frequency are effectively static loads. Buffet levels vary over a wide range on a given aircraft as well as between aircraft. Thus, buffet vibration requirements should be derived from in-flight vibration measurement when possible. As an alternative to measurements, the lowest store vibratory modes can be exercised at conservative levels to show that the store will be robust enough for any encountered buffet vibration. Note that this does not cover the static loads associated with buffet. In order to include these loads, it is necessary to duplicate flight measured dynamic bending moments as discussed as an option in the front section of this method (paragraph 4.2.1.2, Force control strategy). This would require extending the test frequency down to the lowest frequency of airplane buffet response and must be done in coordination with the responsible strength and loads engineers.
- (4) Stores are also susceptible to vibration generated by internal materiel and local aerodynamic effects. There are no accepted criteria or methodology for predicting these environments. However, these environments can be dominating vibration sources and should not be ignored. Whenever they are present, they should be accounted for through development tests and measurements.
 - (a) Internal materiel vibration is typically produced by rotating elements such as electric or hydraulic motors. Any device that generates or incorporates physical motion can produce vibration. Ram air turbines (RAT) are sometimes used to generate electrical or hydraulic power. A RAT can produce high levels of rotating element vibration in addition to severe aerodynamic turbulence at and behind the rotating blades.
 - (b) Acoustic resonance of simple cavities is typically handled as an acoustic environment (see method 515.5). Any hole, opening, inlet, etc. that allows airflow to enter the store or a cavity in the store can produce high intensity acoustic resonance responses.
- b. Captive flight – internal carriage. There are two distinct vibration environments for stores carried in a closed, internal, aircraft bay. These environments occur when the bay is closed to the aircraft external environment and when the bay is open to this environment. Aircraft capable of high angle of attack maneuvers may be susceptible to buffet. Since buffet vibration is mechanically transmitted to the store, the bay will provide no protection. Thus the buffet vibration method discussed above applies.
 - (1) The general vibration environment of a store in a closed bay is very mild. The store is protected from the jet engine noise and aerodynamic turbulence environments and isolated from aircraft vibration. If a store is qualified for external carriage on any jet aircraft, this should more than adequately account for this case. There is no known method to predict this environment for the general case. Measured data may be available for specific aircraft, but generally measurements will be necessary if this environment must be defined.
 - (2) When the bay is opened in flight, a dramatic event occurs. This event is referred to as cavity resonance (references l and m) and results in high levels of turbulence inside the bay. This is wide band turbulence, and unless suppression devices are installed in the bay, with very high spikes across the spectrum. The low frequency portions of the disturbance are not likely to drive the store because disturbance wavelengths greatly differ from store dimensions. The high frequency part of the spectrum will significantly affect the store. Store vibration resulting from this turbulence cannot be adequately predicted. Acoustic characterizations of the turbulence exist for most active aircraft and the resulting vibration is best represented by the acoustic noise exposures of method 515.5.
 - (a) Generally, store flight surfaces (control surfaces, wings, stabilizers, etc.) are small enough (small surface area) and/or stiff enough (lowest resonant frequency above 100 Hz) that they are not significantly excited by this environment. However, in cases in which the control surfaces of the store are relatively large or soft, they may be excited by the open-bay environment. In these cases the store response can result in flight surface failure, high levels of store vibration or both.

- (b) In some instances, a store is carried in one configuration or position until use. Just prior to use, the configuration or position may change, for example, a weapon carried on a rotary launcher inside a weapons bay of a large bomber. The weapon moves from clock position to clock position as other weapons on the launcher are launched. The weapon is exposed to the bay open environment either each time another weapon is launched, or for a relatively long period while several are launched. Another example is a weapon that is extended out of the bay on the launch mechanism prior to launch. Here the environment will change considerably with position. A third example is an optical sensor pod. This type of store can be carried internally, extended into the air stream, configuration changed (e.g., covers over optical windows retract), operated, configuration changed back, and retracted into the closed bay many times in a lifetime. Such variations in environment and configuration must be accounted for.

Note: Door opening, position changes, configuration changes, door closing, etc., should be expected to happen rapidly. Each of these events and possibly a whole sequence of events can happen rapidly enough so that they should be treated as transient (see Annex B, paragraph 2.3.4 and method 516.5) rather than steady state vibration.

- c. Free flight. Vibration will be experienced by stores that are deployed from aircraft, ground vehicles, or surface ships. The sources of vibration for the free flight environment are engine exhaust noise, vibration and noise produced by internal equipment, and boundary layer turbulence.
- (1) Generally, engine exhaust noise levels will be too low to excite significant vibration in the store. This is because the engine only operates when the ratio of the exhaust velocity to the ambient air speed is low and (except in unusual cases) the exhaust plume is behind the store.
 - (2) Vibration produced by onboard materiel can be severe in specific cases. Examples are ram air turbines, engines, and propellers. There is no general basis for predicting store vibrations from such sources. Each case must be evaluated individually and it is likely that measurements will be required.
 - (3) Boundary layer turbulence induced vibration should be as for captive carriage except that store vibration mode frequencies may shift, flight dynamic pressures may be different, and turbulence from the carrier aircraft and nearby stores will be absent.
- d. Exposure levels. Select test levels and spectra for three of the vibration environments, captive flight, free flight, and buffet from Annex C, table 514.5C-V and figures 514.5C-12 and 514.5C-13. The use of these tables and figures is suggested only when there is an absence of satisfactory flight measurements. Except for buffet portions, these criteria are closely based on references u, v, and w. These document the results of an extensive study and include a large amount of information and insight. The buffet criteria are based on reference x and additional measurements and experience with the F-15 aircraft. It represents F-15 wing pylon buffet that is the worst known buffet environment. F-15 fuselage store stations buffet environments are generally less severe. Criteria for the other environments must be determined for each specific case.
- e. Exposure durations. Take durations from the Life Cycle Environment Profile.

2.3.5 Category 16 - Aircraft stores - materiel, jet aircraft.

Materiel installed within a jet aircraft store will experience the store vibration discussed in Annex A, paragraph 2.3.4. The input exposure levels for materiel within the store are essentially the same as response levels of the store. If gunfire, cavity resonance, buffet-maneuver, and free-flight conditions occur for the store, the materiel will also be exposed to these conditions.

- a. Exposure levels. Base vibration criteria on in-flight measurements when possible. If satisfactory flight measurements are not available, derive levels from Annex C, table 514.4C-V and figures 514.5C-13 and 514.5C-14. Note: use input control for vibration testing of this materiel rather than response control (see paragraph 4.2.1).
- b. Exposure durations. Take durations from the Life Cycle Environment Profile.

MIL-STD-810F
1 January 2000
ANNEX A

2.3.6 Category 17 - Aircraft stores - assembled/materiel, propeller aircraft.

There is no known source of general guidance or measured data for the vibration of propeller aircraft stores (except gunfire induced, see method 519.5). However, since the excitation sources are the same, it seems likely that store vibration will be similar to that of the carrying aircraft. See Annex A, paragraph 2.3.2 and Annex B, paragraph 2.3.3 for a discussion of this vibration. Maneuver buffet vibration experienced by stores of highly maneuverable propeller aircraft should be similar to that experienced by jet aircraft stores. See the buffet vibration portion of Annex A, paragraph 2.3.4.

- a. Exposure levels. There is no known source of data. For accurate definition of propeller aircraft store vibration, measurement of the actual environment is essential. The criteria of Annex C, table 514.5C-II and figure 515.5C-9 may be used to develop preliminary estimates of general vibration. The criteria of Annex C, figure 514.5C-13 may be applied for maneuver buffet vibration.
- b. Exposure durations. Take durations from the Life Cycle Environment Profile.

2.3.7 Category 18 - Aircraft stores - assembled/materiel, helicopter.

Complex periodic waveforms characterize the service environment encountered by assembled stores externally carried on helicopters. Unlike stores carried on fixed-wing aircraft, externally mounted helicopter stores receive little aerodynamic excitation, particularly when compared with the rotor-induced vibration. Thus, most of the vibratory energy reaches the store and materiel through the attachment points between the aircraft and the store. Some excitation, however, is added along the entire store structure due to periodic rotor induced pressure fluctuations. The result is a complex response, unique to the particular aircraft-store configuration. Therefore, realistic definition of the environment depends almost totally upon the use of in-flight vibration measurements. For stores exposed to gunfire, refer to method 519.5.

- a. Exposure levels. Derive exposure levels for helicopter-carried store materiel from field measurements (reference f contains criteria for specific helicopters). When measured data are not available, initial estimates can be derived from Annex C, figures 514.5C-10 and 514.5C-11, and table 514.5C-IV prior to acquisition of field data. These levels are intended as worst-case environments and represent environments for which it may be difficult to develop vibration sensitive materiel. Materiel costs are often strongly influenced by the performance required in a vibration environment. Consequently, field measurement based vibration criteria are very important. To determine levels, locate the store relative to the helicopter zones as shown in Annex C, figure 514.5C-11. Most stores will be inside a vertical projection of the main rotor disc and should use the source frequencies of the main rotor in determining the values of A_1 , A_2 , A_3 , and A_4 (see Annex C, table 514.5C-IV). Fundamental main rotor source frequencies of several helicopters are given in table 514.5C-IV.
- b. Exposure durations. When measured data are used to establish exposure levels, take durations from the Life Cycle Environment Profile. When levels are derived from Annex C, figures 514.5C-10 and 514.5C-11, and table 514.5C-IV, use a duration of four (4) hours in each of three (3) orthogonal axes for a total time of twelve (12) hours. This represents a 2500-hour operational life. Use the fatigue relationship of Annex A, paragraph 2.2 to trade test time for exposure level. Perform the calculation separately for each sinusoid and each segment of the broadband background.

2.3.8 Category 19 - Missiles - Tactical missiles (free flight).

There is no known source of general guidance or measured data for tactical missile carriage or launch vibration environments. Environments for jet aircraft, propeller aircraft, and helicopter carried missiles are discussed in Annex A, paragraphs 2.3.4 through 2.3.7. Tactical carriage ground environments are discussed in Annex A, paragraph 2.3.9. Free flight environments are covered in Annex A, paragraphs 2.3.4.c and 2.3.5 in regard to aircraft carried missiles. These environments should be generally applicable to tactical missiles during free flight mission segments.

METHOD 514.5

- a. Exposure levels. There is no known source of data. For accurate definition of tactical missile store vibration, measurement of the actual environment is essential. The criteria of Annex C, table 514.5C-V and figure 515.5C-12 and figure 515.5C-14 may be used to develop preliminary estimates of free flight vibration.
- b. Exposure durations. Take durations from the Life Cycle Environment Profile.

2.3.9 Category 20 - Ground vehicles - ground mobile.

The ground mobile environment consists of broadband random vibration with peaks and notches. These peaks and notches are considerably higher and lower than the mean level. (See ITOP 1-2-601.) Terrain, road, and surface discontinuities, vehicle speed, loading, structural characteristics, and suspension system all affect this vibration. Note that gunfire criteria (method 519.5) are not applicable since it is based on the response of aircraft-type structures that are significantly different than ground vehicle structures.

- a. Wheeled vehicles. There is presently no analytical model of these environments suitable for generalized application. The spectra of Annex C, figures 514.5C-1 through 514.5C-3 are typical of cargo bed responses in wheeled vehicles and trailers. This may be unrealistic for installed materiel since it does not consider vehicle structural response beyond the heavily supported cargo bed. The large assembly cargo test of Annex A, paragraph 2.2.3 can be adapted to provide highly accurate tests for this materiel.
- b. Track-laying vehicles. Track-laying vehicle environment (Annex C, figure 514.5C-4) is characterized by the strong influence of track-laying pattern. This environment is best represented by superimposing narrowband random (track-laying components) vibration at selected frequencies over a broadband random base.
- c. Exposure levels. As discussed above, generalized methodology for estimating ground vehicle vibration levels have not been developed. Whenever possible, actual vibration environments should be measured and the results used to formulate accurate levels and spectrum shapes. When this is not possible or when preliminary estimates are made, for wheeled vehicles, the information, levels, and curves presented in Annex A, paragraphs 2.2.1 and 2.2.2 may be adapted. Numerous measurements have been made and used to develop test criteria for tracked vehicles. Reference f contains criteria that may be used directly or adapted as necessary.
- d. Exposure durations. Take durations from the Life Cycle Environment Profile. Guidance is given in reference f relating durations to exposure levels for various tracked vehicles.

2.3.10 Category 21 - Watercraft - marine vehicles.

Marine vibration spectra have a random component induced by the variability of cruising speeds, sea states, maneuvers, etc., and a periodic component imposed by propeller shaft rotation and hull resonance. Materiel mounted on masts (such as antennas) can be expected to receive higher input than materiel mounted on the hull or deck. The overall ship's structure, materiel mounting structure, and materiel transmissibility (amplifications) greatly affect materiel vibration. Development of shipboard materiel should address both the levels of environmental inputs and the coincidence of materiel/mounting resonances and input frequencies. Note that gunfire vibration criteria per method 519.5 are not applicable since they are based on the response of aircraft type structures that are significantly different than marine vehicle structures.

- a. Exposure levels.
 - (1) Ship/watercraft vibrations are a very complex function of natural environmental forcing function (wave action, wind), induced forcing function (propeller shaft speeds, operation of other equipment, etc.), ship/watercraft structure, materiel mounting structure and materiel response. Even roughly accurate general vibration criteria are not available. Use measurements of actual environments to develop exposure criteria.

MIL-STD-810F
1 January 2000
ANNEX A

- (2) An arbitrary qualification test requirement has been developed for shipboard materiel. This may be used as a crude definition of a total onboard life exposure. It consists of the random levels of Annex C, figure 515.5C-15 for a duration of two hours along each of three orthogonal axes, and the sinusoidal requirements of MIL-STD-167, Type I (reference hh), with levels enveloping the highest values for each frequency. Note that this criteria applies to ships and not to other watercraft. No criteria are known to be available for other watercraft.

- b. Exposure durations. Take durations from the Life Cycle Environment Profile.

2.3.11 Category 22 - Engines - turbine engines.

Vibration spectra for materiel mounted directly on turbine engines consists of a broadband background with narrow band spikes superimposed. The broadband background is the sum of random flow turbulence and low-level quasi-sinusoidal peaks generated by various rotating machinery elements. The narrow band spikes are due to the rotation of the main engine rotor(s) and the frequencies are the rotor rotational speed(s) and harmonics.

- a. Constant speed. Many turbine engines are constant speed. This means that the rpm is held constant and power changes are made through fuel flow changes and variable pitch blades, vanes, and propellers. These machines produce the fixed frequency spikes of Annex C, figure 514.5C-16. These spikes have an associated bandwidth because there is minor rpm drift, the vibration is quasi-sinusoidal (see Annex B, paragraph 2.3.3), and the materiel resonant frequencies vary with serial number and mounting conditions.
- b. Variable speed. Other turbine engines are not constant speed machines. For these engines, the rpm varies with power setting. To represent these engines, adjust the spikes of Annex C, figure 514.5C-16 to include the engine rpm range. Typically, the engine will have an rpm range associated with a power setting (i.e., idle, cruise, max continuous, take off, etc.). Thus, several spectra with different spike frequencies may be needed to represent all of the power conditions encountered during an engine life cycle.
- c. Multiple rotors. Turbofan engines usually have two and sometimes three mechanically independent rotors operating at different speeds. Modify the spectra of Annex C, figure 514.5C-16 to include spikes for each rotor.
- d. Design criteria. These vibration environments can be approximated in the laboratory by the narrowband random over broadband random test described in Annex B, paragraph 2.3. Many vibration problems in this type of environment are associated with the coincidence of materiel resonant modes and the excitation spikes. The notches between spikes are used in intelligent design as safe regions for critical vibration modes. Source dwell tests minimize the likelihood that materiel will be overstressed at non-representative conditions and that reasonable design provisions will not be subverted.
- e. Engine mounts. Engine vibration levels are affected by the engine mounting structure (see Annex B, paragraph 2.4). Thus, the same engine mounted in two different platforms may produce differing levels. Engine test stand levels are very likely to be different than platform levels. Note that the locations of frequency peaks in the vibration spectrum are engine driven and will not change with the installation.
- f. Exposure levels. Measured values should be used when possible. Annex C, figure 514.5-16 levels can be used when measured data are not obtainable. These levels are rough envelopes of data measured on several Air Force aircraft engines.
- g. Exposure durations. Take durations from the Life Cycle Environment Profile.

2.3.12 Category 23 - Personnel - materiel carried by/on personnel.

The human body has highly damped, low frequency modes of vibration. Materiel carried on the body is protected from the vibration environment. Vibrations sufficient to harm materiel would be intolerable if transmitted through the body. Develop personnel materiel to withstand typical vibration environments (shipping, transportation, etc.) when the materiel is not carried by personnel.

METHOD 514.5

514.5A-16

- a. Exposure levels. No personal materiel vibration exposures are required.
- b. Exposure durations. No personal materiel vibration exposure durations are required.

2.4 Supplemental Considerations.

2.4.1 Category 24 - All materiel - minimum integrity test.

In many cases, materiel is designed and tested to requirements based only on operational service environments. Other phases of the environmental life cycle are assumed to be less stringent or not considered. The minimum integrity test is intended to provide reasonable assurance that materiel can withstand transportation and handling including field installation, removal, and repair. This is particularly important for materiel mounted on vibration isolators in service and subjected to handling, transportation, etc., without isolators.

- a. Basis for levels. Vibration levels and durations of Annex C, figures 514.5C-17 and 514.5C-18 are not based on application environments. Rather, experience has shown that materiel that withstands these exposures functions satisfactorily in the field, and that materiel tested to lower levels does not. These exposures are sometimes called "junk level" tests.
- b. Delicate materiel. Use care with delicate materiel. Do not apply this test when the levels are felt to be too high for the materiel. Rather, evaluate the full environmental life cycle and make provisions to ensure that the materiel is adequately protected from vibration and shock during all phases of the environmental life cycle.
- c. Limitations. Do not apply minimum integrity tests to materiel that has been designed and tested to all environments of its life cycle, or to materiel that is otherwise tested to levels and durations that are equivalent to the minimum integrity test by the vibratory fatigue relationships of Annex B, paragraph 2.2.
- d. Exposure levels. Test levels are shown in Annex C, figure 514.5C-17 for general use, and on figure 514.5C-18 for helicopter materiel. Note that these exposures are to be applied directly to the materiel (hard mounted) and not through vibration isolation devices. These exposures are based on typical electronic boxes. When materiel is too large, unnecessarily high loads are induced in mounting and chassis structures, while higher frequency vibrations at subassemblies are too low. In these cases, apply the minimum integrity test to subassemblies. The maximum test weight of a materiel or subassembly should be approximately 36 kg (80 lb).
- e. Exposure durations. Test durations are shown in Annex C, figure 514.5C-17 for general use and on figure 514.5C-18 for helicopter materiel.

2.4.2 Category 25 - All vehicles - cantilevered external materiel.

Materiel that consists of or includes cantilever elements mounted external to a platform are subject to special problems. These problems are relatively rare but when they occur usually result in rapid and complete failure. These problems occur when the cantilevered elements are excited to vibrate in their cantilever bending or torsion modes by interaction with fluid flows.

- a. Excitation mechanisms. Cantilever elements immersed in a fluid flow can vibrate due to several types of self excited vibration and by forced response to pressure fluctuations. The three primary mechanisms are introduced below. For a general discussion of self-excited vibrations and more information on these three mechanisms, see reference y, Chapter 7 and reference z, section 3.6 and chapters 5 and 6.
 - (1) Flutter is a mechanism where the vibrations of a "wing" in a flow are such as to produce lift forces and moments that reinforce and amplify the vibration. A "wing" is a cantilever beam with slender cross section (i.e., the dimension parallel to the airflow is much larger than the dimension perpendicular to the flow). Flutter is not the result of an environmental forcing function. It is a mechanism inherent in a design and once started it needs no further environmental excitation to sustain and amplify the motion. Flutter is a separate engineering specialty and should be handled by

MIL-STD-810F
1 January 2000
ANNEX A

flutter engineers. The vibration engineer needs to recognize flutter and the difference between flutter and other vibrations. Many artificial problems have been generated when other types of vibrations have been mislabeled as flutter. Conversely, flutter problems will not be solved until recognized as such and treated by flutter engineers.

- (a) A simple form is known as stall or stop sign flutter. Stop sign flutter can be seen when a plate (sign) mounted on a single central metal post flaps violently in the wind. This happens when the wind blows roughly parallel, but at a small angle to the vertical plane of the plate. A pressure distribution forms over the plate as with a "wing." These pressures combine as a lifting force located upstream (1/4 mean chord) of the post. This off center force causes the plate to twist the post, increasing the angle between the plate and the wind (angle of attack). Increased angle of attack causes increased lift, more twist of the post and larger angle of attack. This continues until either the post torsional stiffness is sufficient to stop further twisting or until the airflow over the plate stalls. When stall occurs, the center of lift shifts to the plate center (1/2 mean chord) and the twisting moment disappears. The post (torsional spring) returns the sign to the original angle, the flow reestablishes and the plate twists again, repeating the cycle. The cycle then repeats at the frequency of the plate/post torsion mode. With road signs this cycling can go on for long periods of time without failing the simple steel post. However, when a similar oscillation occurs with more sophisticated structures, failure usually occurs rapidly.
 - (b) Classical flutter is a mechanism that involves two (or more) modes. Typically these are the first bending and first torsion modes. As flow speed increases the fluid interacts with the modal masses and stiffnesses, changing modal frequencies. Flutter occurs when modal frequencies converge and the motions of the two modes couple in a mechanism that extracts energy from the fluid flow. For additional information see reference z, section 7.10 or section 3.6.
- (2) When air flows over a blunt cross section (depth \approx height), vortices are shed alternately from one side, and then the other side, producing an oscillating force. These vortices are parallel to the length of the cantilever and propagate downstream as individual elements, dissipating rapidly. A blunt cross section cantilever attached to a platform moving through a fluid is subject to this force. When the excitation frequency is close to a cantilever resonant frequency, vibration will occur. When the vibrating mode is low, damped vibration can be substantial. This is another self-excited rather than an environment driven vibration. However, in this case, unlike flutter, the vibration engineer is usually expected to handle the problem.
- (a) Vibration due to vortex shedding can often be seen in the radio antennae commonly used on automobiles (the single piece non-telescoping type). When moving at speeds of roughly 80 to 97 kilometers per hour (50 to 60 miles per hour) and when there is water on the antenna, the antenna often vibrates at easily visible amplitudes. It would appear that the antennae are not failing because the vibration is in the second bending mode (2 node points). The strain distribution (mode shape) is such (again clearly visible) that dynamic bending stresses are not very high at the root of the cantilever. (It is also suspected that the antennae are made of a low strength steel that fortuitously has good fatigue properties.)
 - (b) Shed frequency and force generated are approximately equal to:

$$f = 0.22 V/D$$

$$F = (1/2 \rho V^2 DL) \sin(2\pi f t)$$

f = frequency

V = velocity

D = cantilever cross section diameter

F = force

ρ = density

t = time

L = the exposed length (perpendicular to the cross section)

(For non-circular cross sections, D becomes the dimension perpendicular to the flow in the frequency equation and the dimension parallel to the flow in the force equation. See reference y, section 7.6 for more information.)

- (3) Forced vibration of external cantilevers by fluctuations in a fluid flow is the same response to aerodynamic turbulence that is a primary source of vibration in aircraft. The factors that make this a special case for cantilevers are the dynamic characteristics of the cantilevers. First, a cantilever exposes a large surface area to the excitation relative to the cross section of the support structure. Second, a cantilever tends to respond with high amplitude motion and large root stresses in the supporting base. Third, when the cantilever has the form of a "wing," aerodynamic lift and drag forces can be produced that add to the fluctuating pressure loads. These aerodynamic forces are produced because the turbulence is a tumbling of the fluid with variations in flow direction and flow velocity. These variations effect the "wing" as variations in angle of attack and flow velocity.
- (a) There are two types of excitation that are important. One is the broadband random turbulence behind any relatively blunt flow obstruction or behind a stalled airfoil. The other is vortices. A vortex forms when the pressures on two sides of a "wing" are different. The flow from the high pressure side wraps around the tip to the low pressure side. This results in a rotating flow trailing downstream of the tip. This rotating flow or vortex is left in the wake of the "wing," is highly stable, and persists for long distances downstream. Such a vortex is highly structured with a sharply peaked frequency distribution.
- (b) Vortex generators (small "wings") are often seen on airplane wings. The vortices generated help to hold the flow in the desired locations over the wing. This phenomenon can be clearly seen during takeoff of Boeing 737 aircraft equipped with CFM 56 (large diameter) engines when the air is humid. There is a vortex generator (small "wing") roughly 20 centimeters by 20 centimeters (8 inches by 8 inches) on the inboard side of each engine cowling. When the aircraft rotates to takeoff attitude, a vortex is formed that moves up over the wing and extends back parallel to the fuselage. Moisture condenses in the vortex, making it clearly visible to passengers seated at windows beside the engine and over the wing.

b. Platform environments.

- (1) Fixed wing aircraft and external stores.
- (a) Any "wing" can flutter. However, this is not likely with blade antennas or the wings, control surfaces, and fins on stores. This is because first bending and first torsion mode frequencies are typically well separated. Any "wing" that has closely spaced bending and torsion mode frequencies should be evaluated by flutter engineers.
- (b) Fixed wing aircraft usually do not have blunt cross section external cantilevers. Anything outside the mold lines is generally streamlined (i.e., airfoil shaped) to reduce drag. However, if blunt cross sections are used, care should be exercised to ensure that shed frequencies and cantilever frequencies are well separated.
- (c) Many fixed wing aircraft have problems due to turbulence forced vibration. Typical problems are failed blade antennae, failed fins on external stores, and failed wings and control surfaces on missiles. Blade antenna problems are usually caused by locating the antenna down stream of a flow disturbance such as a cockpit canopy, a radome that projects into the air stream, or a cavity in the aircraft skin. Severe broadband flow turbulence carries downstream behind the disturbing element for a distance of three to five times the maximum cross sectional dimension of the disturbing element.
- (d) Fins on external stores are typically exposed to turbulence behind the carrying pylon, rack, or leading store. There is a case where a vortex forms in a corner of an engine inlet during high

MIL-STD-810F
1 January 2000
ANNEX A

speed throttle chops. This vortex drops down and moves toward the airplane centerline as it extends aft. There is a single fuselage external store station that is wiped by this vortex. A specific missile carried at this station experienced high vibration levels of wings and control surfaces leading to rapid failure. The missile had to be redesigned to allow carriage on that one station.

(2) Helicopters and external stores.

- (a) Flutter of "wings" on a helicopter is not likely due to the relatively low air speeds. However, if otherwise unexplainable failures occur in "wing" like elements, a flutter engineer should be consulted.
- (b) Flight speeds of helicopters are lower than fixed wing aircraft and streamlining is not as important. Thus, blunt cross section cantilevers are more likely to be used. When blunt cross sections are used, care should be exercised to insure that vortex shed frequencies and cantilever frequencies are well separated.
- (c) Helicopters are also subject to turbulence. However, turbulence produced vibratory loads are proportional to flow speed and helicopter speeds make problems due to turbulence relatively unlikely. It is still prudent to locate cantilevered materiel away from known turbulence.

(3) Ground vehicles.

- (a) The flapping of the fabric cover of an open truck is a form of flutter. Structures of this type will "flutter" and must be strong enough and tied down well enough to prevent carrying away. However, to replace a fabric cover with a stiffened structure is not reasonable. Flutter problems at ground vehicle speeds should be limited to cases of this type.
- (b) Streamlining is usually not a significant factor in ground vehicle design. Thus, blunt cross-section cantilevers and vortex shedding are relatively likely. Exercise care to ensure vortex shed frequencies and cantilever frequencies are separated.
- (c) Forced vibration problems should be extremely rare due to low flow speeds. However, turbulence does exist at any flow speed and could possibly effect large, low frequency structures. The low frequency turbulence produced by large trucks effects the handling of smaller vehicles in close proximity. Vortices in the wakes of large trucks can often be seen in disturbances of roadside dust.

(4) Watercraft.

- (a) For the portion of the platform above water, the discussion for ground vehicles applies. Portions of the platform below water are in a higher density fluid, even though flow speeds are low, the pressures are high. Wake turbulence of watercraft is clearly visible at the water surface. "Wing" materiel is subject to flutter and blunt cantilevers including "wing" elements with blunt trailing edges are subject to vortex shedding. Much of the original work in this technology dealt with watercraft problems.
- (b) Hulls and externally mounted underwater materiel are generally designed for smooth flow at the bow and along the sides but with squared off "boat tail" sterns. Turbulence driven forced vibration should not be a problem in smooth flow areas. However, anything located downstream of a "boat tail" will be subjected to high levels of flow turbulence.

c. Exposure levels.

- (1) Exposure levels are not pertinent to flutter or other instabilities. These mechanisms, if they occur, will either drive the system to rapid, complete failure or will persist at high levels resulting in rapid fatigue or wear failure. The correct procedure is to design the materiel such that these mechanisms do not occur. When instabilities are discovered, the correct procedure is to understand and then eliminate the mechanism. This is accomplished by determining the mode shapes and frequencies of

those resonances participating in the instability and, if possible, the characteristics of the flow field. Eliminating the mechanism is done by changing modal frequencies, mode shapes, modal damping, and/or flow characteristics. This is accomplished by changing modal mass, stiffness, or damping and/or by changing aerodynamic shapes. (See reference z, section 6.1.) Dynamic absorbers are often useful in changing modal properties (see reference y, sections 3.2 and 3.3).

- (2) Vortex shedding driven vibration also generally leads to rapid fatigue or wear failure. This problem typically involves a single mode of vibration of the materiel. If possible, the problem should be eliminated by separating the shed frequency and the resonant frequency (ideally by a factor of 2). If this is not practical, it may be possible to survive this mechanism for useful periods of time with good design. Good design consists of using materials with good fatigue properties, elimination of high stress points, and adding damping. In order to define exposure levels, it is necessary to measure the motions of the cantilever on the platform in the operating environment. These measurements are used to define modal responses. When laboratory tests are required, response control is necessary. This is because the primary energy input is directly from the fluid flow. Response of the cantilever to this input is greater than the response to the vibration environment at the mount.
 - (3) Local turbulence is not predictable except in a very general sense. Problems of this type should be avoided whenever possible by locating materiel away from known turbulence areas. Beyond this, it is necessary to operate the platform through its operational envelope and evaluate problems as they occur. When problems are discovered, the first approach should be to determine the source of the turbulent wake that is causing the problem and to move the materiel out of this wake. If this is not possible, proceed as discussed for vortex shedding problems.
- d. Exposure durations. As discussed above, problems should be solved by eliminating instability mechanisms or by moving materiel away from turbulence. If it is necessary to define exposure durations, take them from the life cycle profile. Note that these problems may occur in very specific regions of an operating envelope. It may be necessary to break missions down to a very detailed level in order to define realistic durations.

MIL-STD-810F
1 January 2000
ANNEX A

THIS PAGE INTENTIONALLY BLANK

ANNEX B

ENGINEERING INFORMATION

1. SCOPE.

1.1 Purpose.

This Annex provides information intended to be useful in interpreting the main body and Annex A of method 514.5.

1.2 Application.

The following discussions concern basic engineering information. They are intended as a quick introduction to the subject matter and are offered without detailed explanations, mathematics, or references. If further information or understanding is required, the technical literature and engineering textbooks should be consulted. Reference aa is recommended as a starting point.

2. ENGINEERING INFORMATION.

2.1 Vibration Test Types.

The following presents discussions of general types of vibration tests. The nomenclature and descriptions are based on U. S. Air Force aircraft practices. Other test types, definitions, and names will be found in practice. All of these test types may not be applied to a given materiel item. A typical materiel development might include development testing and durability testing, while another might include qualification and reliability testing. Environmental worthiness testing is included when needed. Environmental Stress Screening (ESS) is a part of most current DOD acquisitions. All of the tests, including ESS, consume vibratory fatigue life. It should be assumed that a qualification test, a durability test, or a reliability test consumes the test article such that it is not suitable for field deployment. Development tests and worthiness tests may or may not consume a complete life depending on the specific test goals. It is important to insure that ESS consumes only an appropriate, hopefully negligible, portion of total life and that this portion is accounted for in the total life cycle of vibration exposures. In all cases it is vital to tailor test methodology, requirements, and success or failure criteria to achieve the desired results.

2.1.1 Development test.

Development testing is used to determine characteristics of materiel, to uncover design and construction deficiencies, and to evaluate corrective actions. Begin as early as practical in the development and continue as the design matures. The ultimate purpose is to assure that developed materiel is compatible with the environmental life cycle and that formal testing does not result in failure. The tests have a variety of specific objectives. Therefore, allow considerable freedom in selecting test vibration levels, excitation, frequency ranges, and durations. Typical programs might include modal analysis to verify analytical mode shapes and frequencies, and sine dwell, swept sine, transient, or random excitation transient vibration to evaluate function, fatigue life, or wear life. The test types, levels, and frequencies are selected to accomplish specific test objectives. Levels may be lower than life cycle environments to avoid damage to a prototype, higher to verify structural integrity, or raised in steps to evaluate performance variations and fragility.

2.1.2 Qualification test.

Qualification testing is conducted to determine compliance of a materiel with specific environmental requirements. Note that these tests are a simplified, shortened expression of the environmental life cycle. For most items, this consists of a functional test and an endurance test (sometimes combined). The functional test represents the worst case vibration (or envelope of worst case conditions) of the environmental life cycle. The endurance test is an

MIL-STD-810F
1 January 2000
ANNEX B

accelerated fatigue test representing an entire life cycle. Typically, vibration is not combined with other environmental stresses although part of the vibration test may be at high temperature and part at low temperature. An exception might be the transportation of large assemblies where a production assembly is subjected to the test environment and then fielded.

2.1.3 Functional test.

Functional testing is conducted to verify that the materiel functions as required while exposed to worst case operational vibration. Fully verify function at the beginning, middle and end of each test segment. Monitor basic function at all times during each test run. Functional test levels are normally maximum service levels. When separate functional and endurance tests are required, split the functional test duration, with one half accomplished before the endurance test and one half after the endurance test (in each axis). The duration of each half should be sufficient to fully verify materiel function or one half hour (per axis), whichever is greater. This arrangement has proven to be a good way of adequately verifying that materiel survives endurance testing in all respects. In some cases, materiel that must survive severe worst case environments may not be required to function or function at specification levels during worst case conditions. Typically "operating" and "non-operating" envelopes are established. Tailor functional tests to accommodate non-operating portions by modifying required functional monitoring requirements as appropriate.

2.1.4 Endurance test.

In the past, endurance test duration was normally set at one hour per axis. This approach has serious shortcomings.

- a. Conventional approach. In the past, test levels were usually established by raising functional levels to account for equivalent fatigue damage. Another approach was to assume that if enough stress cycles (usually assumed to be 10^6 cycles) were accumulated without failure, that this demonstrated that the stresses were below the material endurance limit. Each of these approaches has serious shortcomings. The first requires testing at vibration levels well above levels seen in service. This ignores nonlinearity of material properties, joint friction, isolator performance, heat buildup, etc. The second ignores the fact that many materials (particularly those typical of electrical/electronic devices) do not exhibit endurance limits and that 10^6 stress cycles may not be sufficient for those that do.
- b. Recommended approach. Use the simplified fatigue relationship below (see Annex B, paragraph 2.2, below) to determine the time at maximum service levels (functional levels) that is equivalent to a vibration lifetime (levels vary throughout each mission). Use the equivalent time as the functional test duration, thereby combining functional and endurance tests. There may be cases when this test duration is too long to be compatible with program restraints. In these cases, use as long of a test duration as is practical and use the fatigue relationship to define the test level. While this approach does not completely eliminate nonlinearity questions, it does limit levels to more realistic maximums.

2.1.5 Durability test.

Durability testing is a simulation of the environmental life cycle to a high degree of accuracy. A durability analysis precedes the test and is used to determine which environmental factors (vibration, temperature, altitude, humidity, etc.) must be included in the test to achieve realistic results. Although the test is intended to be a real time simulation of the life cycle, it may be shortened by truncation if feasible. Truncation is the elimination of time segments that are shown by the durability analysis to be benign with regard to materiel function and life. Durability analyses should use fatigue and fracture data applicable to each material rather than the simplified expressions of Annex B, paragraph 2.2 below.

- a. Worst case levels. Mission portions of the environmental life cycle are represented in the durability test by mission profiles. Mission profiles are statistical definitions of environmental stress and materiel duty cycle versus time. Mission profiles often do not include worst case environmental stresses because they are encountered too rarely to be significant statistically. However, it is important to verify that materiel

METHOD 514.5

514.5B-2

will survive and function as needed during extreme conditions. Therefore, insert maximum environmental levels into the durability test, in a realistic manner. For example, in the case of a fighter airplane, the maximum levels would be inserted during an appropriate combat mission segment rather than a more benign segment such as cruise.

- b. Success criteria. Pass/fail criteria for durability tests are established for the particular effort. Criteria could include no failures, a maximum number of failures, a maximum amount of maintenance to fix failures, or some combination of these.

2.1.6 Reliability test.

Reliability testing is accomplished to obtain statistical definitions of materiel failure rates. These tests may be development tests or qualification tests. The accuracy of the resulting data is improved by improving realism of the environmental simulation. Test requirements are developed by engineers responsible for materiel reliability. Multiple test items are often exposed to segments of a life cycle rather than one materiel test item exposed to a complete life cycle. The environmental simulation is established to fit these requirements and is generally similar to the durability testing discussed above.

2.1.7 Worthiness test.

When unqualified materiel is to be evaluated in the field, verification that the materiel will function satisfactorily is normally required for safety and/or test efficiency reasons. This is accomplished by environmental worthiness test. The worthiness test is identical to a qualification test except that it covers only the life cycle of the field evaluation. Levels are usually typical operating levels unless safety is involved; then maximum operating levels are necessary. Durations are either equivalent to a complete system/subsystem test, long enough to check materiel function, or an arbitrary short time (5 or 10 minutes). For safety driven worthiness test, the test item is considered to be consumed by the test (the test item may not be used in the field). An identical item of hardware is used in the field evaluation. When safety is not an issue, an item may be subjected to a minimum time functional test and then used in the field evaluation. When it is required to evaluate the cumulative environmental effects of vibration and environments such as temperature, altitude, humidity, leakage or EMI/EMC, a single test item should be exposed to all environmental conditions.

2.1.8 Environmental Stress Screen (ESS).

ESS is not an environmental test. It is a production or maintenance acceptance inspection technique. However, it is an environmental life cycle event and should be included as preconditioning or as part of the test as appropriate. Materiel may be subject to multiple ESS cycles and maintenance ESS vibration exposures may differ from production acceptance exposures. ESS should be included in development tests only as appropriate to the test goals. Qualification tests should include maximum lifetime ESS exposure. Worthiness safety tests should include the maximum ESS exposure appropriate to the particular materiel. When materiel is to be subjected to worthiness test and then used in the field, it may be wise to substitute a worthiness test for ESS. This subjects the materiel to the minimum amount of vibration while showing field worthiness. Durability tests should include maximum ESS events in the correct positions in the life cycle simulation. For reliability tests, it may be appropriate to vary the ESS exposures between minimum and maximum.

2.2 Fatigue Relationship.

The following relationship may be used to determine vibratory fatigue equivalency between vibration exposures, to sum vibratory fatigue damage of separate vibration exposures, and to define accelerated test levels for vibration endurance tests:

$$(W_0/W_1) = (T_1/T_0)^{1/4} \quad \text{or} \quad (g_0/g_1) = (T_1/T_0)^{1/6}$$

MIL-STD-810F
1 January 2000
ANNEX B

W = random vibration level (acceleration spectral density, g^2/Hz)

g = sinusoidal vibration level (peak acceleration, g)

T = Time

This relationship is a simplified expression of linear fatigue damage accumulation. The exponent is the material constant (slope of a log/log fatigue or S/N curve). The values given are widely used for Air Force avionics. Other values are used for other types of materiel. For example, missile programs have used exponents ranging from 1/3.25 to 1/6.6. Space programs sometimes use 1/2. Many materials exhibit exponents between 1/6 and 1/6.5. This wide variation is based on degree of conservatism desired as well as material properties. More sophisticated analyses based on fatigue data (S/N curves) for specific materials should be used when practical. Note that using material S/N curves results in different equivalencies for different parts in a given materiel item. A decision will be required as to which equivalency to use to establish test criteria.

2.3 Vibration Characterization.

The majority of vibration experienced by materiel in operational service is broadband in spectral content. That is, vibration is present at all frequencies over a relatively wide frequency range at varying intensities. Vibration amplitudes may vary randomly, periodically, or mixed random and periodic. Usually, random vibration best simulates these environments. Situations do occur where combined sinusoidal and random vibration and sinusoidal alone are appropriate. Most vibration tests run with steady state excitation. Steady state vibration is appropriate at times in simulation of transient events. However, there are cases where transient events can only be satisfactorily represented by transient vibration excitation.

2.3.1 Random vibration.

Random vibration is expressed as acceleration spectral density (also referred to as power spectral density, or PSD) spectra. The acceleration spectral density at a given frequency is the square of the root mean square (rms) value of the acceleration divided by the bandwidth of the measurement. This gives a value expressed in terms of a one Hertz bandwidth centered on the given frequency. Accuracy of spectral values depends on the product of the measurement bandwidth and the time over which the spectral value is computed. The normalized random error for a spectral estimate is given by $1/(BT)^{1/2}$, where B is the analysis bandwidth in Hz. and T is the averaging time in seconds. In general, use the smallest practical bandwidth or minimum frequency resolution bandwidth, with 1 Hz being ideal. In most cases, acceleration amplitude has a normal (Gaussian) distribution. Other amplitude distributions may be appropriate in specific cases. Ensure that test and analysis hardware and software are appropriate when non-Gaussian distributions are encountered.

- a. Frequency range. Acceleration spectral density is defined over a relevant frequency range. This range is between the lowest and highest frequencies at which the materiel may be effectively excited by mechanical vibration. Typically, the low frequency is one half the frequency of the lowest resonance of the materiel or the lowest frequency at which significant vibration exists in the environment. The high frequency is two times the highest materiel resonant frequency, the highest frequency at which significant vibration exists in the environment, or the highest frequency at which vibration can be effectively transmitted mechanically. It is generally accepted that the highest frequency for mechanically transmitted vibration is 2000 Hz, although practically it is often lower. (When frequencies around and above 2000 Hz are needed, it is generally necessary to augment the vibration with acoustic noise - see method 523.2.)
- b. Rms values. The use of rms values to specify random vibration is not valid. The spectrum rms value is the square root of the area under the spectral density curve over the total frequency range. It contains no frequency information. Rms values are useful as a general error check and as a measure of power needed to run a vibration shaker. Definitions of vibration should always include frequency spectra.

METHOD 514.5

514.5B-4

2.3.2 Sinusoidal vibration.

Sine vibration is expressed as an acceleration and a frequency. An environment dominated by sine vibration is characterized by a fundamental frequency and harmonics (multiples) of that fundamental. Often there will be more than one fundamental frequency. Each fundamental will generate harmonics. The service vibration environment in some cases (low performance propeller aircraft and helicopters for example) contains excitation that is basically sinusoidal in nature and with a very low broadband background. The excitation derives from engine rotational speeds, propeller and turbine blade passage frequencies, rotor blade passage, and their harmonics. Environments such as this may be best simulated by a sinusoidal test. Ensure that the frequency range of the sinusoidal exposure is representative of the platform environment.

2.3.3 Mixed broadband and narrowband vibration.

In some cases, the vibration environment is characterized by quasi-periodic excitation from reciprocating or rotating structures and mechanisms (e.g., rotor blades, propellers, pistons, gunfire). When this form of excitation predominates, source dwell vibration is appropriate. Source dwell is characterized by broadband random vibration, with higher level narrowband random, or sinusoidal vibration superimposed. Exercise care when determining levels of random and sinusoidal vibration from measured data since data reduction techniques affect the apparent amplitudes of these different types of signals.

- a. Narrowband random over broadband random. Ensure that the amplitudes and frequencies of the total spectrum envelope the environment. The narrowband bandwidth(s) should encompass or be cycled through frequencies representative of variations of the environment and variations of materiel resonant frequency (see Annex B, paragraph 2.4.3).
- b. Sinusoid(s) over broadband random background. Ensure that the random spectrum is continuous over the frequency range and that it envelopes all of the environment except for the amplitude(s) to be represented by the sinusoid(s). The sinusoid(s) amplitude(s) should envelop the sinusoid(s) in the environment. Cycle the sinusoid(s) frequency(s) through bands representative of frequency variations in the environment and resonant frequency variations in materiel (see Annex B, paragraph 2.4.3).

2.3.4 Transient vibration.

Transient vibration is a time-varying "windowed" portion of a random vibration that is of comparatively short duration, e.g., 0.5 second to 7.5 seconds. Currently, such a measured environment is replicated in the laboratory on a vibration exciter under open loop waveform control. Verification of the laboratory test is provided by (1) display of the laboratory measured amplitude time history; (2) an optimally smooth estimate of the amplitude time history time-varying root-mean-square, and (3) either an energy spectral density estimate or a Shock Response Spectrum (SRS) estimate for comparatively short environments (transient vibration duration less than the period of the first natural mode of the test item) or a time-varying autospectral density estimate of longer duration environments, e.g., 2.5 to 7.5 seconds. In general, since the environment is being replicated in the laboratory under open loop waveform control, if the impulse response function of the system is correctly determined and correctly applied, then the replication should be near identical to the measured environment. The transient vibration environment is an important environment for stores resident in platform weapon bays that may be exposed to such environments many times in the life of training missions. (See references c, bb, and method 516.5.)

2.3.5 Random versus sinusoidal vibration equivalence.

In the past, most vibration was characterized in terms of sinusoids. Currently, most vibration is correctly understood to be random in nature and is characterized as such. This results in a demand to determine equivalence between random and sine vibration. This demand is generated by the need to utilize materiel that was developed to sine requirements.

- a. General equivalence. Sine and random characterizations of vibration are based on distinctly different sets of mathematics. In order to compare the effects of given random and sine vibration on materiel, it is

MIL-STD-810F
1 January 2000
ANNEX B

necessary to know the details of materiel dynamic response. A general definition of equivalence is not feasible.

- b. g_{rms} . Often, attempts are made to compare the peak acceleration of sine to the rms acceleration of random. The only similarity between these measures is the dimensional units that are typically acceleration in standard gravity units (g). Peak sine acceleration is the maximum acceleration at one frequency (see Annex B, paragraph 2.3.2). Random rms is the square root of the area under a spectral density curve (see Annex B, paragraph 2.3.1). These are not equivalent!

2.4 Platform/Materiel and Fixture/Test Item Interaction.

Generally, it is assumed that the vibration environment of the materiel is not affected by the materiel itself. That is, the vibration of the platform at the materiel attachment point would be the same whether or not the materiel is attached. Since the entire platform, including all materiel, vibrates as a system, this is not strictly correct. However, when the materiel does not add significantly to the mass or stiffness of the platform, the assumption is correct within reasonable accuracy. The following sections discuss the limitations of this assumption. Note that these effects also apply to sub-elements within materiel and to the interactions of materiel with vibration excitation devices (shakers, slip tables, fixtures, etc.).

2.4.1 Mechanical impedance.

- a. Large mass items. At platform natural frequencies where structural response of the platform is high, the materiel will load the supporting structures. That is, the mass of the materiel is added to the mass of the structure, and it inertially resists structural motions. If the materiel mass is large compared to the platform mass, it causes the entire system to vibrate differently by lowering natural frequencies and changing mode shapes. If the materiel inertia is large compared to the stiffness of the local support structure, it causes the local support to flex, introducing new low frequency local resonances. These new local resonances may act as vibration isolators (see Annex B, paragraph 2.4.2 below).
- b. Items acting as structural members. When materiel is installed such that it acts as a structural member of the platform, it will affect vibrations and it will be structurally loaded. This is particularly important for relatively large materiel items but it applies to materiel of any size. In these cases, the materiel structure adds to the stiffness of the platform and may significantly affect vibration modes and frequencies. Further, the materiel will be subjected to structural loads for which it may not have been designed. An example is a beam tied down to the cargo deck of a truck, aircraft, or ship. If the tie-downs are not designed to slip at appropriate points, the beam becomes a structural part of the deck. When the deck bends or twists, the beam is loaded and it changes the load paths of the platform structure. This may be catastrophic for the beam, the platform, or both. Be careful in the design of structural attachments to assure that the materiel does not act as a structural member.
- c. Large item mass relative to supporting structures. When materiel items are small relative to the overall platform but large relative to supporting structures, account for the change in local vibration levels, if practical. This effect is discussed in Annex A, paragraph 2.3.1 for materiel mounted in jet aircraft. Note that due to differences in environments, relative sizes, and structural methods, the factor defined in Annex C, table 514.5C-III is only applicable to materiel mounted in full sized jet aircraft.
- d. Large item size relative to platform. When materiel is large in size or mass relative to the platform, always consider these effects. This is imperative for aircraft and aircraft stores. Catastrophic failure of the aircraft is possible. It is also imperative to consider these effects in design of vibration test fixtures. Otherwise, the vibration transmitted to the test materiel may be greatly different than intended.

2.4.2 Vibration isolation.

Vibration isolators (shock mounts), isolated shelves, and other vibration isolation devices add low-frequency resonances to the dynamic system that attenuate high-frequency vibration inputs to materiel. Vibration inputs at the

METHOD 514.5

514.5B-6

isolation frequencies (materiel six degree-of-freedom rigid body modes) are amplified, resulting in substantial rigid body motions of the isolated materiel. Effective performance of these devices depends on adequate frequency separation (factor of two minimum) between materiel resonant frequencies and isolation frequencies, and on adequate sway space (clearance around isolated materiel) to avoid impacts of the isolated materiel with surrounding materiel (possibly also vibration isolated and moving) and structure.

- a. Sway space. Include sway amplitude and isolation characteristics (transmissibility versus frequency) in all design analyses and measure them in all vibration tests. Isolation devices are nonlinear with amplitude. Evaluate these parameters at vibration levels ranging from minimum to maximum. Note: these comments also apply to isolated sub-elements within materiel items.
- b. Minimum ruggedness. All materiel should have a minimum level of ruggedness, even if protected by isolation in service use and shipping. Thus, when materiel development does not include all shipping and handling environments of the materiel life cycle, include the appropriate minimum integrity exposures in materiel (Annex A, paragraph 2.4.1).

2.4.3 Materiel resonant frequency variation.

The installed resonant frequencies of materiel varies from those of the laboratory test. One cause is the small variations between serial items from an assembly process. Tightness of joints, slight differences in dimensions of parts and subassemblies, and similar differences effect both the resonant frequencies and the damping of the various modes of the item. A second cause is the interaction between the materiel and the mounting. As installed for field use, a materiel item is tied to mounting points that have an undefined local flexibility and that move relative to each other in six degrees of freedom as the platform structure vibrates in its modes. In a typical laboratory test, the test item is tied to a massive, very stiff fixture intended to transmit single axis vibration uniformly to each mounting point. In each case the mounting participates in the vibration modes of the materiel item and in each case the influence is different. When defining test criteria, consider these influences. Both in the cases of measured data and arbitrary criterion, add an allowance to narrow band spectral elements. Plus and minus five per cent has been chosen for the propeller aircraft criteria of Annex A, paragraph 2.3.2. This was chosen because it seemed to be a reasonable number, and because enveloped C-130 and P-3 aircraft data (references p through t) in g^2/Hz form exhibited approximately this bandwidth.

2.5 Modal Test and Analysis.

Modal test and analysis is a technique for determining the structural dynamic characteristics of materiel and test fixtures. Modal tests, (reference cc) also known as ground vibration tests (GVT) and ground vibration surveys (GVS), apply a known dynamic input to the test item and the resulting responses are measured and stored. Modal analysis methods are applied to the measured data to extract modal parameters (resonant frequencies, mode shapes, modal damping, etc.). Modal parameters are used to confirm or generate analytical models, investigate problems, determine appropriate instrumentation locations, evaluate measured vibration data, design test fixtures, etc. Modal analysis methods range from frequency domain, single degree of freedom methods to time domain, multi-degree of freedom methods (references dd and ee).

2.5.1 Modal test techniques.

Modal analysis may be accomplished in various ways. The simplest method consists of inputting sine vibration with a shaker, adjusting the frequency and amplitude output of the shaker to excite a structural mode, measuring outputs with a roving accelerometer, and hand plotting the results. This process is repeated for each structural mode of interest. A more sophisticated approach would utilize multi-shaker wide band random excitation, simultaneous measurement of signals from an accelerometer and force gage array, and computer computation and storage of frequency response functions (FRF). Techniques such as random burst and instrumented hammer excitation are available. Select methodology that will result in well-understood usable data, and that will provide the level or detail needed for the specific test goals.

MIL-STD-810F
1 January 2000
ANNEX B

2.5.2 Material non-linear behavior.

Dynamic inputs should be at as realistic levels as possible and at as many levels as practical because materiel response is generally nonlinear with amplitude.

2.6 Aerodynamic Effects.

A primary source of vibration in aircraft and aircraft stores is the aerodynamic flow over the vehicle. Oscillating pressures (turbulence) within the flow drive vibration of the airframe surfaces. These pressures and thus the vibration are a linear function of dynamic pressure and a non-linear function of Mach number. When a flow becomes supersonic, it smoothes out and turbulence drops off. Then, as speed increases, further turbulence builds up again. This phenomenon is well illustrated in the vibration data contained in reference k. The Mach corrections given in Annex C, table 514.5C-V are based on an average of this data. The following definitions and the values and the formulas of Annex C, table 514.5C-VI are provided for use in calculating airspeeds and dynamic pressures. The formulas are somewhat complex and in the past it was common to use simplified graphical equivalents. With the availability of modern computers and programmable calculators these simplifications are no longer justified. The source of the formulas is reference ff and the source of the atmospheric values is reference gg.

2.6.1 Dynamic pressure.

The total pressure of a gas acting on an object moving through it is made up of static pressure plus dynamic pressure (q). The proportions vary with speed of the body through the gas. Dynamic pressure is related to speed by $q = 1/2 \rho V^2$ where ρ is the density of the gas and V is the velocity of the object through the gas.

2.6.2 Airspeed.

The speed of an aircraft moving through the atmosphere is measured in terms of airspeed or Mach number. There are several forms of airspeed designation. These are discussed below. At sea level these are equal, but as altitude increases they diverge. Equations and data required for airspeed and dynamic pressure calculations are provided in Annex C, table 514.5C-VI. These are based on references ff and gg.

- a. Calibrated airspeed. Airspeed is usually specified and measured in calibrated airspeed. Calibrated airspeed is typically expressed in nautical miles per hour (knots) and designated knots calibrated air speed (Kcas). Kcas is not true airspeed. It is derived from quantities that are directly measurable in flight. Since it is not true airspeed, it cannot be used in the simple formula for q given above.
- b. Indicated airspeed. Another form of airspeed measurement is indicated airspeed. Calibrated airspeed is indicated airspeed when empirical corrections are added to account for factors in the specific aircraft installation. Indicated airspeed is expressed in various units (kilometers per hour, miles per hour, and knots) but in military aircraft, it is normally in knots indicated airspeed (Kias).
- c. Equivalent airspeed. Equivalent airspeed is a form directly related to dynamic pressure. It is sometimes used in engineering calculations since other forces (lift, drag, and structural air-loads) acting on an airframe are also proportional to dynamic pressure. However, it is not used in airspeed measurement systems or flight handbooks. Equivalent airspeed may be expressed in various units but it is usually seen as knots equivalent airspeed (Keas).
- d. True airspeed. This is the actual airspeed. To calculate true airspeed with an aircraft air data system, local atmospheric properties must be accurately known. This was not practical until recent years and aircraft generally do not use true airspeed in handbooks nor to navigate. True airspeed may be expressed in various units but it is usually seen as knots true airspeed (Ktas).
- e. Mach number. Mach number is the ratio of true airspeed to the speed of sound. When Mach number is measured by an aircraft air data system, it is true Mach number.

2.6.3 Altitude.

Aircraft air data systems measure local atmospheric pressure and convert this value to pressure altitude through a standard atmosphere model that relates pressure, temperature, and density. Pressure altitude is used in the equations relating airspeeds and dynamic pressure. Care must be exercised to assure that altitudes are pressure altitudes. Often, low altitude values for modern military aircraft are given as absolute height above local terrain. These values should be changed to pressure altitude values. Guidance from engineers familiar with mission profile development is required to make this adjustment.

2.7 Similarity.

It is often desirable to use materiel in an application other than that for which it was developed. Also, changes are made to existing materiel or the environmental exposures of an application change. The question arises as to how to verify that the materiel is suitable for the application. This is usually accomplished through a process called "qualification by similarity." Unfortunately, this process has never had a generally accepted definition. In practice it sometimes devolves to a paper exercise that provides traceability but has no engineering content. The following is an adaptation of a set of criterion that was provided to an Air Force avionics program. It is suggested as a basis for vibration similarity criteria. Tailor the criteria for materiel type, platform environments, and program restraints. Change the emphasis from circuit cards to the particular critical elements when the materiel is not an electronic box. Also, change the fatigue equation exponents as appropriate.

2.7.1 Unmodified materiel.

Qualify unmodified materiel (items that have not been changed in any way) by documented evidence that one of the following is met:

- a. The materiel was successfully qualified by test to vibration criteria that equals or exceeds the vibration requirements of the application.
- b. The materiel has demonstrated acceptable reliability in an application where vibration environments and exposure durations are equal to or more stringent than the vibration requirements of the application.
- c. The materiel was successfully qualified by test to vibration criteria that is exceeded by application requirements by no more than 6 dB in maximum test level, and by no more than 50% in fatigue damage potential at each frequency. In addition, vibration response at critical resonances is such that materiel life and function will be acceptable in the application.

2.7.2 Modified materiel.

Qualify modified materiel (items that have been changed in any way) by documented evidence that the unmodified materiel meets the vibration requirements for the application supplemented by analyses and/or test data demonstrating that the modified materiel is dynamically similar to the unmodified materiel.

2.7.3 Equal vibration environment.

Previous test(s) or other vibration exposure(s) are considered to equal the application requirement when all of the following conditions are met:

- a. Previous exposures were the same type of vibration as the application requirement. That is, random vibration must be compared to random criteria and sine must be compared to sine.
- b. The exposure frequency range encompasses the application frequency range. Use a low frequency limit of the range that is the low frequency limit of the application requirement, or 1/2 of the lowest materiel resonant frequency, whichever is higher. The high frequency limit of the range is the high frequency limit of the application requirement.

MIL-STD-810F
1 January 2000
ANNEX B

- c. The exposure level (acceleration spectral density level or peak sinusoidal acceleration as applicable) is no more than 3.0 dB below the application requirement at any frequency and was at or above the requirement for at least 80% of the total bandwidth.
- d. The fatigue damage potential of the exposure(s) is not less than 50% of the application fatigue damage potential at each frequency. And, the fatigue damage potential of the exposure(s) equals or exceeds the application fatigue damage potential over 80% of the frequency range. State fatigue damage potentials as totaled equivalent exposure times at maximum application levels. Base summations and equivalencies on the following relationships.

$$W_1/W_2 = (T_2/T_1)^{1/4}$$

W_1 = Acceleration spectral density of exposure 1 (g^2/Hz)

W_2 = Acceleration spectral density of exposure 2 (g^2/Hz)

T_1 = Duration of exposure 1 (hours)

T_2 = Duration of exposure 2 (hours)

$$g_1/g_2 = (T_2/T_1)^{1/6}$$

g_1 = Peak sinusoidal acceleration of exposure 1 (g)

g_2 = Peak sinusoidal acceleration of exposure 2 (g)

T_1 = Duration of exposure 1 (hours)

T_2 = Duration of exposure 2 (hours)

2.7.4 Reliability data.

Use field reliability data that meets all of the following criteria:

- a. The numbers of fielded materiel from which the data were taken are sufficient to statistically represent the specific materiel item.
- b. The field service seen by the materiel from which the data were taken is representative of the design environmental life cycle.
- c. The field reliability data satisfies maintainability, mission readiness, mission completion, and safety requirements.

2.7.5 Critical resonant response.

Evaluate the first three natural frequencies of the chassis, the first natural frequency of each sub assembly, and the first natural frequency of each circuit card with the following procedure:

- a. Determine the required set (first set) of natural frequencies by test.
- b. Compare maximum levels at which the materiel is required to operate for the original qualification and for the application environment. Define the set (second set) of frequencies at which the application environment exceeds the original levels.
- c. Determine which resonances of the first set coincide with the frequencies of the second set. Show by test or analysis that the materiel will function as required when these resonances are exposed to the application environment maximum levels.
- d. Use the procedure of Annex B, paragraph 2.7.3 above to compare the fatigue damage potential of the original qualification and the application environment. Define the set (third set) of frequencies at which the application fatigue damage potential exceeds the fatigue damage potential of the original criteria.

- e. Determine which resonances of the first set coincide with the frequencies of the third set. Show by test or analysis that the required materiel life will be obtained when these resonances are exposed to the application fatigue damage potential.

2.7.6 Dynamic similarity.

Consider modified materiel as dynamically similar to baseline materiel when all of the following apply:

- a. The total change in mass of the unit and of each subassembly is within $\pm 10\%$.
- b. The unit center of gravity is within $\pm 10\%$ of the original location in any direction.
- c. The mounting configuration is unchanged.
- d. The mounting configuration of circuit cards is unchanged.
- e. The first three natural frequencies of the chassis and the first natural frequency of each subassembly are within $\pm 5\%$ of the original frequencies.
- f. The first natural frequency of each circuit board is within $\pm 10\%$ of the original frequency.
- g. Each modified circuit card is vibrated for one hour in the axis perpendicular to the plane of the board. Use a test exposure that is $0.04 \text{ g}^2/\text{Hz}$ from 15 to 1000 Hz rolled off at 6 dB per octave to 2000 Hz. Maintain electrical continuity throughout the card during and after the test. (Where vibration levels and durations at board level are known, these may be substituted for the stated exposure.)
- h. Changes to mounts, chassis, internal support structures, and circuit card materials are to materials with equal or greater high cycle fatigue strength.

MIL-STD-810F
1 January 2000
ANNEX B

THIS PAGE INTENTIONALLY BLANK

ANNEX C

TABLES AND FIGURES

1. SCOPE.

1.1 Purpose.

This Annex provides tables and figures associated with the main body, Annex A, and Annex B of method 514.5.

2. TABLES.

TABLE 514.5C-I. Typical mission / field transportation scenario.

| PORT STAGING AREA (PSA) | CORPS STAGING AREA (CSA) | FORWARD SUPPLY POINT (FSP) | USING UNIT (USU) | EXPENDITURE |
|-------------------------|---------------------------------|---------------------------------|--|-------------------------------|
| | 600 km (375 miles) ←————→ | 200 km (125 miles) ←————→ | 26 km (16 miles) ←————→ | 26 km (16 miles) ←————→ |
| | Trucks, Semitrailers ←————→ | Two-Wheeled Trailers ←————→ | Two-Wheeled Trailers or M548 Cargo Carrier ←————→ | |

TABLE 514.5C-II. Propeller aircraft vibration exposure.

| MATERIEL LOCATION <u>1/</u> , <u>2/</u> , <u>3/</u> , <u>4/</u> | VIBRATION LEVEL L_0 (g^2/Hz) |
|--|---------------------------------------|
| In fuselage or wing forward of propeller | 0.10 |
| Within one propeller blade radius of propeller passage plane | 1.20 |
| In fuselage or wing aft of propeller | 0.30 |
| In engine compartment, empennage, or pylons | 0.60 |
| <u>1/</u> For Materiel mounted to external skin, increase level by 3 dB. <u>2/</u> f_0 = blade passage frequency (propeller rpm times number of blades) (Hz). $f_1 = 2 \times f_0$ $f_2 = 3 \times f_0$ $f_3 = 4 \times f_0$ <u>3/</u> Spike bandwidths are $\pm 5\%$ of center frequency. <u>4/</u> C-130 Aircraft 3 blade propeller - $f_0 = 51$ Hz 4 blade propeller - $f_0 = 68$ Hz 6 blade propeller - $f_0 = 102$ Hz (C-130J) | |

MIL-STD-810F
1 January 2000
ANNEX C

TABLE 514.5C-III. Jet aircraft vibration exposure.

| | |
|---|---|
| $W_0 = W_A + \sum_1^n (W_J)$ | |
| W_0, W_A, W_J - Exposure levels in acceleration spectral density (g^2/Hz). | |
| Aerodynamically induced vibration | |
| $W_A = a \times b \times c \times (q)^2$ | |
| Jet engine noise induced vibration | |
| $W_J = \{[0.48 \times a \times d \times \cos^2(\theta)/R] \times [D_c \times (V_c / V_r)^3 + D_f \times (V_f / V_r)^3]\}$ | |
| a | - Platform/Materiel interaction factor (see Annex B, paragraph 2.4). Note that this factor applies to W_0 and not to the low frequency portion (15 Hz to break) of figure 514.5C-14. = 1.0 for materiel mounted on vibration isolators (shock mounts) and materiel weighing less than 36 kg. = $1.0 \times 10^{(0.6 - W/60)}$ for materiel weighing between 36 and 72.12 kg. (w = weight in kg) = 0.25 for materiel weighing 72.12 kg or more. |
| b | - Proportionality factor between vibration level and dynamic pressure (SI units). = 2.96×10^{-6} for materiel mounted on cockpit instrument panels. = 1.17×10^{-5} for cockpit materiel and materiel in compartments adjacent to external surfaces that are smooth and free from discontinuities. = 6.11×10^{-5} for materiel in compartments adjacent to or immediately aft of external surface discontinuities (cavities, chines, blade antennae, speed brakes, etc.), fuselage aft of wing trailing edge, wing, empennage, and pylons. |
| | \sum_1^n - Jet noise contribution is the sum of the W_J values for each engine. |
| | d - Afterburner factor. = 1.0 for conditions where afterburner is not used or is not present. = 4.0 for conditions where afterburner is used. |
| | R - Vector distance from center of engine exhaust plane to materiel center of gravity, m (ft). |
| | θ - Angle between R vector and engine exhaust vector (aft along engine exhaust centerline), degrees For $70^\circ < \theta \leq 180^\circ$ use 70° . |
| c | - Mach number correction. Note that this factor applies to W_0 and not to the low frequency portion (15 to TBD Hz at 0.04 g^2/Hz) of figure 514.5C-8. (Annex A, paragraph. 2.3.1) = 1.0 for $0 \leq \text{Mach} \leq 0.9$ = $(-4.8M + 5.32)$ for $0.9 \leq \text{Mach} \leq 1.0$ (where M = Mach number) = 0.52 for Mach number greater than 1.0 |
| | D_c - Engine core exhaust diameter, m (ft). |
| | D_f - Engine fan exhaust diameter, m (ft). |
| | V_r - Reference exhaust velocity, m/sec (ft/sec). = 564 m/sec |
| | V_c - Engine core exhaust velocity Engine core exhaust velocity (without afterburner), m/sec (ft/sec). |
| | V_f - Engine fan exhaust velocity (without afterburner), m/sec (ft/sec). |
| q | - Flight dynamic pressure, kN / m^2 (lb/ft ²). (See Annex B, para. 2.6.1 and table 5145C-VI) |
| If Dimensions are in feet and pounds then: | |
| a | = 1.0 for materiel mounted on vibration isolators (shock mounts) and materiel weighing less than 80 lb. = $1.0 \times 10^{(0.60 - 0.0075 W)}$ for materiel weighing between 80 and 160 lb. = 0.25 for materiel weighing 160 lb. or more. |
| b | = 6.78×10^{-9} , 2.70×10^{-8} , or 1.40×10^{-7} in the order listed above. |
| V_r | = 1850 feet/second |

TABLE 514.5C-IV. Helicopter vibration exposure.

| MATERIEL LOCATION | RANDOM LEVELS | SOURCE FREQUENCY (f_x) RANGE (Hz) | PEAK ACCELERATION (A) at f_x (GRAVITY UNITS (g)) | |
|--|--|--|---|--------------------|
| General | $W_0 = 0.0010 \text{ g}^2/\text{Hz}$ $W_1 = 0.010 \text{ g}^2/\text{Hz}$ $f_t = 500 \text{ Hz}$ | 3 to 10 10 to 25 25 to 40 40 to 50 50 to 500 | $0.70 / (10.70 - f_x)$ $0.10 \times f_x$ 2.50 $6.50 - 0.10 \times f_x$ 1.50 | |
| Instrument Panel | $W_0 = 0.0010 \text{ g}^2/\text{Hz}$ $W_1 = 0.010 \text{ g}^2/\text{Hz}$ $f_t = 500 \text{ Hz}$ | 3 to 10 10 to 25 25 to 40 40 to 50 50 to 500 | $0.70 / (10.70 - f_x)$ $0.070 \times f_x$ 1.750 $4.550 - 0.070 \times f_x$ 1.050 | |
| External Stores | $W_0 = 0.0020 \text{ g}^2/\text{Hz}$ $W_1 = 0.020 \text{ g}^2/\text{Hz}$ $f_t = 500 \text{ Hz}$ | 3 to 10 10 to 25 25 to 40 40 to 50 50 to 500 | $0.70 / (10.70 - f_x)$ $0.150 \times f_x$ 3.750 $9.750 - 0.150 \times f_x$ 2.250 | |
| On/Near Drive System Elements | $W_0 = 0.0020 \text{ g}^2/\text{Hz}$ $W_1 = 0.020 \text{ g}^2/\text{Hz}$ $f_t = 2000 \text{ Hz}$ | 5 to 50 50 to 2000 | $0.10 \times f_x$ $5.0 + 0.010 \times f_x$ | |
| Main or Tail Rotor Frequencies (Hz) Determine 1P and 1T from Specific Helicopter or from Table (below). | | | Drive Train Component Rotation Frequency (Hz) Determine 1S from Specific Helicopter and Component. | |
| $f_1 = 1P$ | $f = 1T$ | fundamental | $f = 1S$ | fundamental |
| $f = n \times 1P$ | $f = m \times 1T$ | blade passage | $f = 2 \times 1S$ | 1st harmonic |
| $f = 2 \times n \times 1P$ | $f = 2 \times m \times 1T$ | 1st harmonic | $f = 3 \times 1S$ | 2nd harmonic |
| $f = 3 \times n \times 1P$ | $f = 3 \times m \times 1T$ | 2nd harmonic | $f = 4 \times 1S$ | 3rd harmonic |
| Helicopter | MAIN ROTOR | | TAIL ROTOR | |
| | Rotation Speed 1P (Hz) | Number of Blades n | Rotation Speed 1T (Hz) | Number of Blades m |
| AH-1 | 540 | 2 | 27.7 | 2 |
| AH-6J | 7.80 | 5 | 47.5 | 2 |
| AH-64(early) | 4.82 | 4 | 23.4 | 4 |
| AH-64(late) | 4.86 | 4 | 23.6 | 4 |
| CH-47D | 3.75 | 3 | 2 main rotors and no tail rotor | |
| MH-6H | 780 | 5 | 47.5 | 2 |
| OH-6A | 8.10 | 4 | 51.8 | 2 |
| OH-58A/C | 590 | 2 | 43.8 | 2 |
| OH-58D | 660 | 4 | 39.7 | 2 |
| UH-1 | 540 | 2 | 27.7 | 2 |
| UH-60 | 430 | 4 | 19.8 | 4 |

MIL-STD-810F
1 January 2000
ANNEX C

TABLE 514.5C-V. Jet aircraft external store vibration exposure.

| $W_1 = 5 \times 10^{-3} \times K \times A_1 \times B_1 \times C_1 \times D_1 \times E_1$; (g ² /Hz) <u>1/</u> $W_2 = H \times (q/\rho)^2 \times K \times A_2 \times B_2 \times C_2 \times D_2 \times E_2$; (g ² /Hz) <u>1/</u> $M \leq 0.90$, $K = 1.0$; $0.90 \leq M \leq 1.0$, $K = -4.8 \times M + 5.32$; $M \geq 1.0$, $K = 0.52$ <u>2/</u> $f_1 = C(t/R^2)$, (Hz) <u>3/ 4/ 5/</u> $f_2 = f_1 + 1000$, (Hz) <u>3/</u> $f_0 = f_1 + 100$, (Hz) <u>6/ 7/</u> | | | | | | | |
|---|-------------------|-----------------------|-------------------|-----------------------------|----------------|----------------|----------------|
| Configuration | | Factors | | Configuration | | Factors | |
| Aerodynamically clean | | A ₁ | A ₂ | | | B ₁ | B ₂ |
| Single store | | 1 | 1 | Powered missile, aft half | | 1 | 4 |
| Side by side stores | | 1 | 2 | Other stores, aft half | | 1 | 2 |
| Behind other store(s) | | 2 | 4 | All stores, forward half | | 1 | 1 |
| Aerodynamically dirty <u>8/</u> | | C ₁ | C ₂ | | | D ₁ | D ₂ |
| Single and side by side | | 2 | 4 | Field assembled sheet metal | | | |
| Behind other store(s) | | 1 | 2 | fin / tailcone unit | | 8 | 16 |
| Other stores | | 1 | 1 | Powered missile | | 1 | 1 |
| | | E ₁ | E ₂ | Other stores | | 4 | 4 |
| Jelly filled firebombs | | 1/2 | 1/4 | | | | |
| Other stores | | 1 | 1 | | | | |
| <p>M – Mach number. H – Constant = 5.59 (metric units) (= 5 × 10⁻⁵ English units). C – Constant = 2.54 × 10³ (metric units) (= 1.0 × 10⁵ English units). q – Flight dynamic pressure (see table 514.5C-VI) – kN/m² (lb/ft²). ρ – Store weight density (weight/volume) - kg/m³ (lb/ft³). Limit values of ρ to 641 ≤ ρ ≤ 2403 kg/m³ (40 ≤ ρ ≤ 150 lb/ft³). t – Average thickness of structural (load carrying) skin - m (in). R – Store characteristic (structural) radius m (in) (Average over store length). = Store radius for circular cross sections. = Half or major and minor diameters for elliptical cross section. = Half or longest inscribed chord for irregular cross sections. <u>1/</u> – When store parameters fall outside limits given, consult references. <u>5/</u> – Limit (t/R²) to: 0.0010 ≤ (t/R²) ≤ 0.020 <u>2/</u> – Mach number correction (see Annex B, 2.6) <u>6/</u> – f₀ = 500 Hz for cross sections not circular or elliptical <u>3/</u> – Limit f₁ to 100 ≤ f₁ ≤ 2000 Hz <u>7/</u> – If f₀ > 200 Hz then use f₀ = 2000 Hz <u>4/</u> – Free fall stores with tail fins, f₁ = 125 Hz <u>8/</u> – Configurations with separated aerodynamic flow within the first 1/4 of the store length. Blunt noses, optical flats, sharp corners, and open cavities are some potential sources of separation. Any nose other than smooth, rounded, and gently tapered is suspect. Aerodynamics engineers should make this judgment.</p> | | | | | | | |
| Representative parameter values | | | | | | | |
| Store type | Max q | | ρ | | f ₁ | f ₂ | |
| | kN/m ² | (lb/ft ²) | kg/m ³ | (lb/ft ³) | Hz | Hz | |
| Missile, air to ground | 76.61 | (1600) | 1602 | (100) | 500 | 1500 | |
| Missile, air to air | 76.61 | (1600) | 1602 | (100) | 500 | 1500 | |
| Instrument pod | 86.19 | (1800) | 801 | (50) | 500 | 1500 | |
| Dispenser (reusable) | 57.46 | (1200) | 801 | (50) | 200 | 1200 | |
| Demolition bomb | 57.46 | (1200) | 1922 | (120) | 125 | 1100 | |
| Fire bomb | 57.46 | (1200) | 641 | (40) | 100 | 1100 | |

METHOD 514.5

514.5C-4

TABLE 514.5C-VI. Dynamic pressure calculation.

| (See Annex B, paragraph 2.6.2 for definitions and details) | | | | |
|---|--|-------------------------------------|--|--------------------------------------|
| 1. Airspeed may be used at Mach numbers less than one. | | | | |
| 2. Mach number may be used at any airspeed. | | | | |
| 3. Unless specifically stated otherwise, assume airspeeds to be in calibrated airspeed (K_{cas}). | | | | |
| 4. When airspeed values are given as indicated airspeed (K_{ias}), assume K_{ias} equal K_{cas} . | | | | |
| 5. Altitude (h) is pressure altitude and not height above terrain. | | | | |
| $q = 2.5 \rho_o \sigma V_a^2 [(1/\delta) \{ [1 + 0.2 (V_{cas}/V_{ao})^2]^{3.5} - 1 \} + 1]^{2/7} - 1]$ $q = 1/2 \rho_o \sigma V_a^2 M^2 \quad q = 1/2 \rho_o V_{eas}^2 \quad q = 1/2 \rho_o \sigma V_{tas}^2$ | | | | |
| | $h \leq 11000 \text{ m}$ | $11000 \leq h \leq 20056 \text{ m}$ | $(h \leq 36089 \text{ ft})$ | $36089 \leq h \leq 65800 \text{ ft}$ |
| θ | $1 - 2.2556 \times 10^{-5} h$ | 0.75189 | $1 - 6.8750 \times 10^{-6} \times h$ | 0.75189 |
| δ | $\theta^{5.2561}$ | $0.2234 e^\phi$ | $\theta^{5.2561}$ | $0.2234 e^\phi$ |
| σ | $\theta^{4.2561}$ | $0.2971 e^\phi$ | $\theta^{4.2561}$ | $0.2971 e^\phi$ |
| V_a | $V_{ao} \times \theta^{1/2}$ | 295.06 | $V_{ao} \times \theta^{1/2}$ | 968.03 |
| λ | ----- | $(11000 - h) / 6342.0$ | ----- | $(36089 - h) / 20807$ |
| ρ_o | 1.2251×10^{-3} | 1.2251×10^{-3} | 2.377×10^{-3} | 2.377×10^{-3} |
| V_{ao} | 340.28 | ----- | 1116.4 | ----- |
| T_o | 288.16°K | ----- | 518.69°R | ----- |
| V_{cas} | - Calibrated airspeed, m/sec (ft/sec) | | ρ_o - Sea level atmospheric density kg/m^3 (slugs/ft ³ or lb sec ² /ft ⁴) | |
| V_{ias} | - Indicated airspeed, m/sec (ft/sec) | | δ - Ratio of local atmospheric pressure to sea level atmospheric pressure | |
| V_{eas} | - Equivalent airspeed, m/sec (ft/sec) | | σ - Ratio of local atmospheric density to sea level atmospheric density (standard atmosphere) | |
| V_{tas} | - True airspeed, m/sec (ft/sec) ($V_{tas} = V_{eas} = V_{cas} = V_{ias}$ at sea level) | | θ - Ratio of temperature at altitude to sea level temperature (standard atmosphere) | |
| V_{ao} | - Sea level speed of sound, m/sec (ft/sec) | | λ - Stratospheric altitude variable | |
| V_{ias} | - Local speed of sound, m/sec (ft/sec) | | | |
| M | - Mach number | | | |
| q | - Dynamic pressure, kN/m^2 (lb/ft ²) | | | |
| h | - Pressure altitude, m (ft), (standard atmosphere) | | | |
| T_o | - Sea level atmospheric temperature °K (°R) | | | |
| Airspeeds are typically expressed in knots as follows: | | | | |
| V_{kcas} - knots calibrated air speed | | | | |
| V_{kias} - knots indicated air speed | | | | |
| V_{keas} - knots equivalent air speed | | | | |
| V_{ktas} - knots true air speed | | | | |
| [knots = nautical miles per hour (knots x 0.51478 = m/sec)(knots x 1.6889 = ft/sec)] | | | | |
| Calculation Check Cases | | | | |
| Airspeed | $h = 3048 \text{ m}$ | $(h = 10000 \text{ ft})$ | $h = 15240 \text{ m}$ | $(h = 50000 \text{ ft})$ |
| $500 V_{kcas}$ | $q = 38.5 \text{ kN/m}^2$ | $(q = 804 \text{ lb/ft}^2)$ | $q = 23.8 \text{ kN/m}^2$ | $(q = 497 \text{ lb/ft}^2)$ |
| $500 V_{ktas}$ | $q = 30.0 \text{ kN/m}^2$ | $(q = 626 \text{ lb/ft}^2)$ | $q = 6.18 \text{ kN/m}^2$ | $(q = 129 \text{ lb/ft}^2)$ |
| $M = 0.8$ | $q = 31.2 \text{ kN/m}^2$ | $(q = 652 \text{ lb/ft}^2)$ | $q = 5.20 \text{ kN/m}^2$ | $(q = 109 \text{ lb/ft}^2)$ |
| $500 V_{keas}$ | $q = 40.6 \text{ kN/m}^2$ | $(q = 848 \text{ lb/ft}^2)$ | at all altitudes | |

MIL-STD-810F
1 January 2000
ANNEX C

TABLE 514.5C-VII. Break points for curves of figures 514.5C-1 through 514.5C-3.

| U. S. highway truck vibration exposures figure 514.5C-1 | | | | | | Composite two-wheeled trailer vibration exposures figure 514.5C-2 | | | | | |
|--|--------------------|-------------|--------------------|--------------|--------------------|--|--------------------|------------|--------------------|--------------|--------------------|
| vertical | | transverse | | longitudinal | | vertical | | transverse | | longitudinal | |
| Hz | g ² /Hz | Hz | g ² /Hz | Hz | g ² /Hz | Hz | g ² /Hz | Hz | g ² /Hz | Hz | g ² /Hz |
| 10 | 0.01500 | 10 | 0.00013 | 10 | 0.00650 | 5 | 0.2252 | 5 | 0.0474 | 5 | 0.0563 |
| 40 | 0.01500 | 20 | 0.00065 | 20 | 0.00650 | 8 | 0.5508 | 6 | 0.0303 | 6 | 0.0563 |
| 500 | 0.00015 | 30 | 0.00065 | 120 | 0.00020 | 10 | 0.0437 | 7 | 0.0761 | 8 | 0.1102 |
| 1.04 g rms | | 78 | 0.00002 | 121 | 0.00300 | 13 | 0.0253 | 13 | 0.0130 | 13 | 0.0140 |
| | | 79 | 0.00019 | 200 | 0.00300 | 15 | 0.0735 | 15 | 0.0335 | 16 | 0.0303 |
| | | 120 | 0.00019 | 240 | 0.00150 | 19 | 0.0143 | 16 | 0.0137 | 20 | 0.0130 |
| | | 500 | 0.00001 | 340 | 0.00003 | 23 | 0.0358 | 21 | 0.0120 | 23 | 0.0378 |
| | | 0.204 g rms | | 500 | 0.00015 | 27 | 0.0123 | 23 | 0.0268 | 27 | 0.0079 |
| | | | | 0.740 g rms | | 30 | 0.0286 | 25 | 0.0090 | 30 | 0.0200 |
| | | | | | | 34 | 0.0133 | 28 | 0.0090 | 33 | 0.0068 |
| Composite wheeled vehicle vibration exposures figure 514.5C-3 | | | | | | 36 | 0.0416 | 30 | 0.0137 | 95 | 0.0019 |
| vertical | | transverse | | longitudinal | | 41 | 0.0103 | 34 | 0.0055 | 121 | 0.0214 |
| Hz | g ² /Hz | Hz | g ² /Hz | Hz | g ² /Hz | 45 | 0.0241 | 37 | 0.0081 | 146 | 0.0450 |
| 5 | 0.2308 | 5 | 0.1373 | 5 | 0.0605 | 51 | 0.0114 | 46 | 0.0039 | 153 | 0.0236 |
| 8 | 0.7041 | 9 | 0.0900 | 6 | 0.0577 | 95 | 0.0266 | 51 | 0.0068 | 158 | 0.0549 |
| 12 | 0.0527 | 12 | 0.0902 | 8 | 0.0455 | 111 | 0.0166 | 55 | 0.0042 | 164 | 0.0261 |
| 16 | 0.0300 | 14 | 0.0427 | 12 | 0.0351 | 136 | 0.0683 | 158 | 0.0029 | 185 | 0.0577 |
| 20 | 0.0235 | 16 | 0.0496 | 15 | 0.0241 | 147 | 0.0266 | 235 | 0.0013 | 314 | 0.0015 |
| 22 | 0.0109 | 18 | 0.0229 | 16 | 0.0350 | 185 | 0.0603 | 257 | 0.0027 | 353 | 0.0096 |
| 24 | 0.0109 | 119 | 0.0008 | 19 | 0.0092 | 262 | 0.0634 | 317 | 0.0016 | 398 | 0.0009 |
| 26 | 0.0154 | 146 | 0.0013 | 25 | 0.0159 | 330 | 0.0083 | 326 | 0.0057 | 444 | 0.0027 |
| 69 | 0.0018 | 166 | 0.0009 | 37 | 0.0041 | 360 | 0.0253 | 343 | 0.0009 | 500 | 0.0014 |
| 79 | 0.0048 | 201 | 0.0009 | 41 | 0.0060 | 500 | 0.0017 | 384 | 0.0018 | 2.40 g rms | |
| 87 | 0.0028 | 273 | 0.0053 | 49 | 0.0017 | 3.85 g rms | | 410 | 0.0008 | | |
| 123 | 0.0063 | 289 | 0.0021 | 105 | 0.0006 | | | 462 | 0.0020 | | |
| 161 | 0.0043 | 371 | 0.0104 | 125 | 0.0004 | | | 500 | 0.0007 | | |
| 209 | 0.0057 | 382 | 0.0019 | 143 | 0.0013 | | | 1.28 g rms | | | |
| 224 | 0.0150 | 402 | 0.0077 | 187 | 0.0013 | | | | | | |
| 247 | 0.0031 | 422 | 0.0027 | 219 | 0.0028 | | | | | | |
| 278 | 0.0139 | 500 | 0.0016 | 221 | 0.0068 | | | | | | |
| 293 | 0.0037 | 1.60 g rms | | 247 | 0.0325 | | | | | | |
| 357 | 0.0028 | | | 249 | 0.0098 | | | | | | |
| 375 | 0.0052 | | | 270 | 0.0026 | | | | | | |
| 500 | 0.0011 | | | 293 | 0.0094 | | | | | | |
| 2.18 g rms | | | | 336 | 0.0120 | | | | | | |
| | | | | 353 | 0.0247 | | | | | | |
| | | | | 379 | 0.0085 | | | | | | |
| | | | | 431 | 0.0224 | | | | | | |
| | | | | 433 | 0.0092 | | | | | | |
| | | | | 500 | 0.0014 | | | | | | |
| | | | | 1.96 g rms | | | | | | | |

METHOD 514.5

514.5C-6

TABLE 514.5C-VIII. Break points for figure 514.5C-6.

| C-5 | | | KC-10 | | | C/KC-135, E/KE-3 | | | C-17 | | |
|--------------|----------|--------|--------------|----------|--------|------------------|----------|--------|--|----------|--------|
| Hz | g^2/Hz | dB/Oct | Hz | g^2/Hz | dB/Oct | Hz | g^2/Hz | dB/Oct | Hz | g^2/Hz | dB/Oct |
| 15 | 0.003 | | 15 | 0.0038 | | 10 | 0.002 | | 5 | 0.005 | |
| 1000 | 0.003 | | 1000 | 0.0038 | | 66.897 | 0.002 | | 66.897 | 0.005 | |
| | | -6 | | | -6 | | | 6 | | | 6 |
| 2000 | 7.5E-4 | | 2000 | 9.5E-4 | | 150 | 0.01 | | 150 | 0.025 | |
| rms = 2.11 g | | | rms = 2.38 g | | | 500 | 0.01 | | 500 | 0.025 | |
| | | | | | | | | -6 | | | -6 |
| | | | | | | 2000 | 6.3E-4 | | | | |
| | | | | | | rms = 2.80 g | | | 2000 | 1.6E-3 | |
| | | | | | | | | | rms = 4.43 g | | |
| C-141 | | | T-43 (737) | | | General Exposure | | | Note: C-17 levels apply to the primary cargo floor. Levels for items carried on the aft ramp are higher. | | |
| Hz | g^2/Hz | dB/Oct | Hz | g^2/Hz | dB/Oct | Hz | g^2/Hz | dB/Oct | | | |
| 15 | 0.002 | | 10 | 0.015 | | 15 | | | | | |
| 39.086 | 0.002 | | 20 | 0.015 | | 105.94 | 0.01 | | | | |
| | | 4 | | | -9 | | | 6 | | | |
| 300 | 0.03 | | 34.263 | 0.003 | | 150 | 0.02 | | | | |
| 700 | 0.03 | | 46.698 | 0.003 | | 500 | 0.02 | | | | |
| | | -9 | | | 9 | | | -6 | | | |
| 2000 | 0.0013 | | 80 | 0.015 | | 2000 | 1.3E-3 | | | | |
| rms = 5.01 g | | | 500 | 0.015 | | rms = 3.54 g | | | | | |
| | | | | | -6 | | | | | | |
| | | | 2000 | 9.5E-4 | | | | | | | |
| | | | rms = 3.54 g | | | | | | | | |

MIL-STD-810F
 1 January 2000
 ANNEX C

3. FIGURES

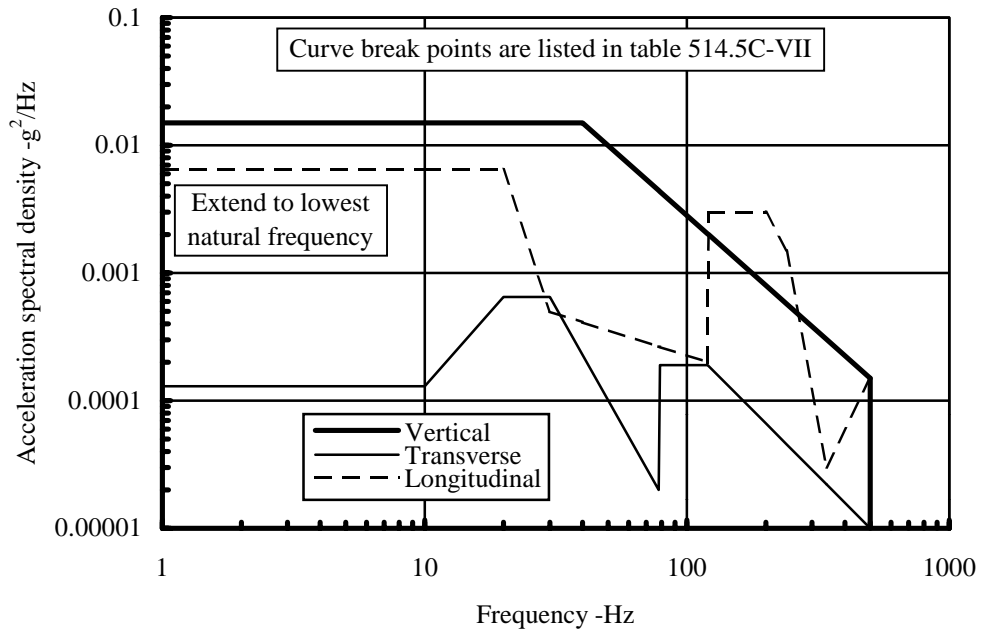

FIGURE 514.5C-1. U. S. highway truck vibration exposure.

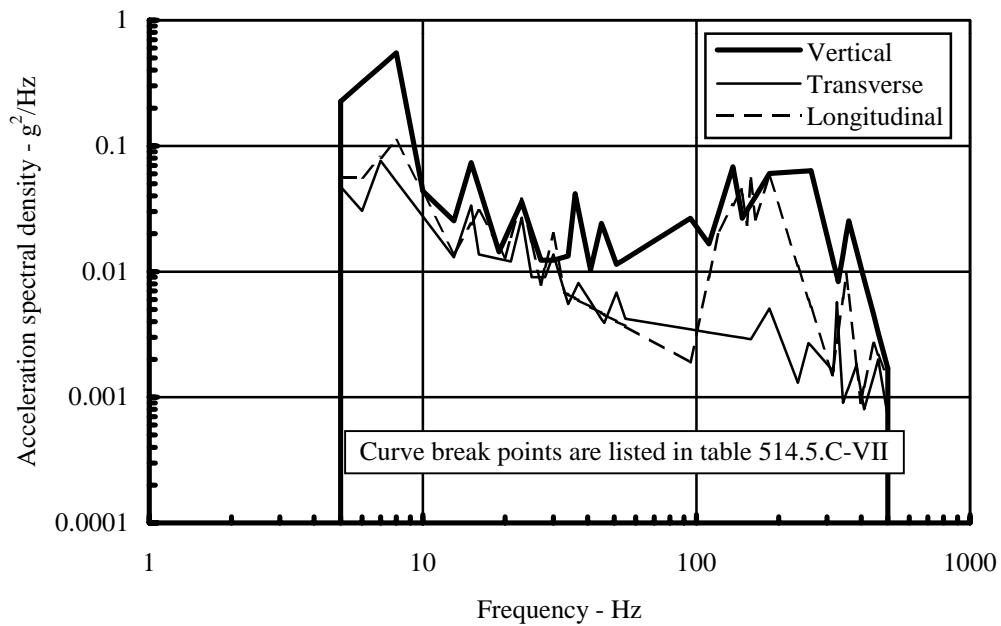

FIGURE 514.5C-2. Composite two-wheeled trailer vibration exposure.

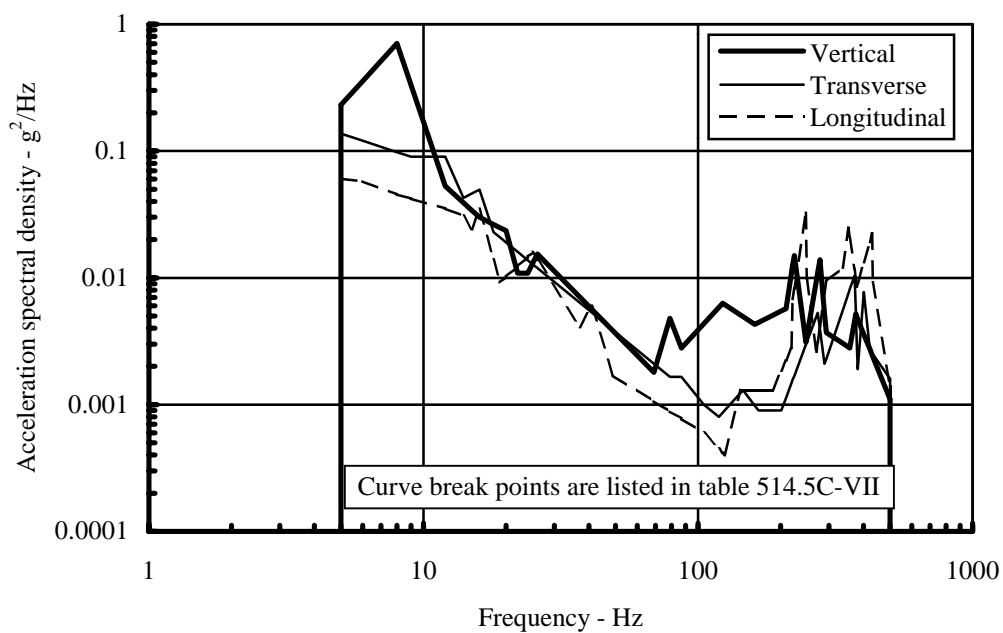

FIGURE 514.5C-3. Composite wheeled vehicle vibration exposure.

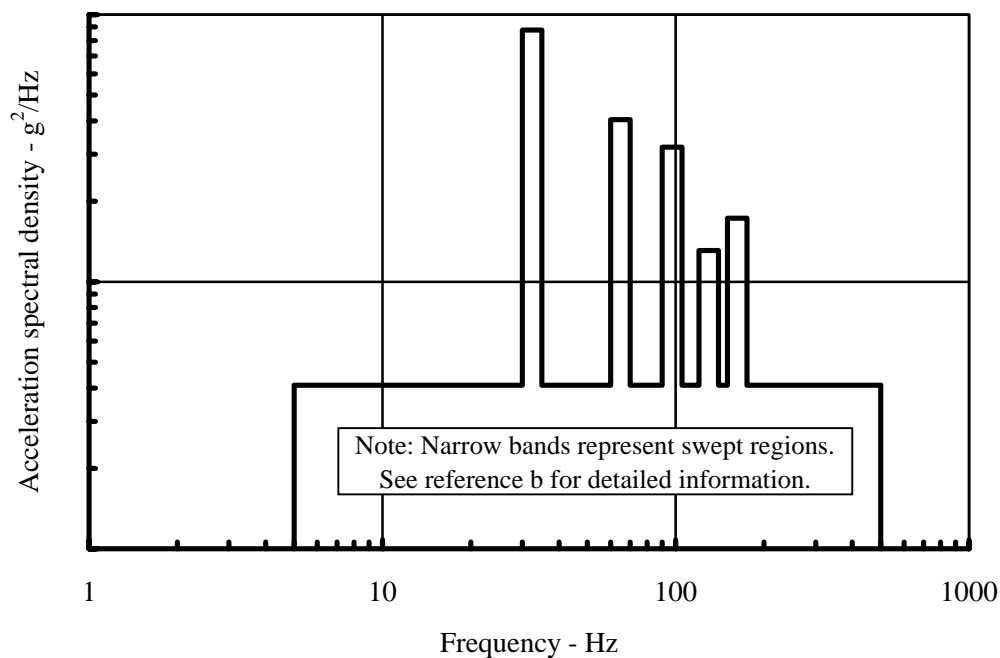

FIGURE 514.5C-4. Tracked vehicle representative spectral shape.

MIL-STD-810F
 1 January 2000
 ANNEX C

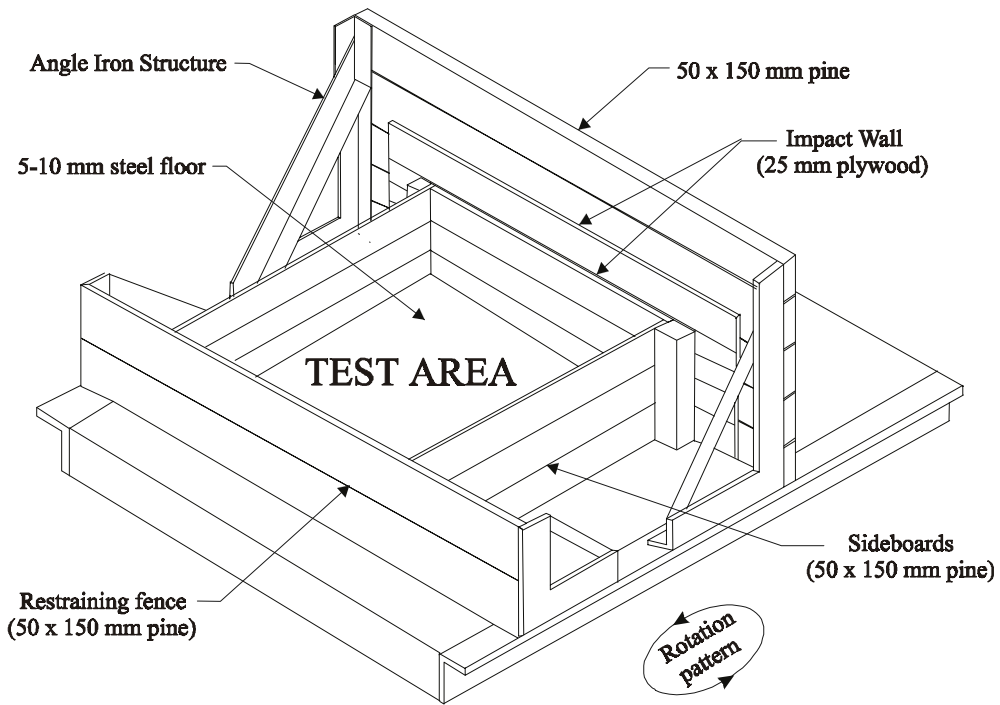

FIGURE 514.5C-5. Loose cargo test setup.

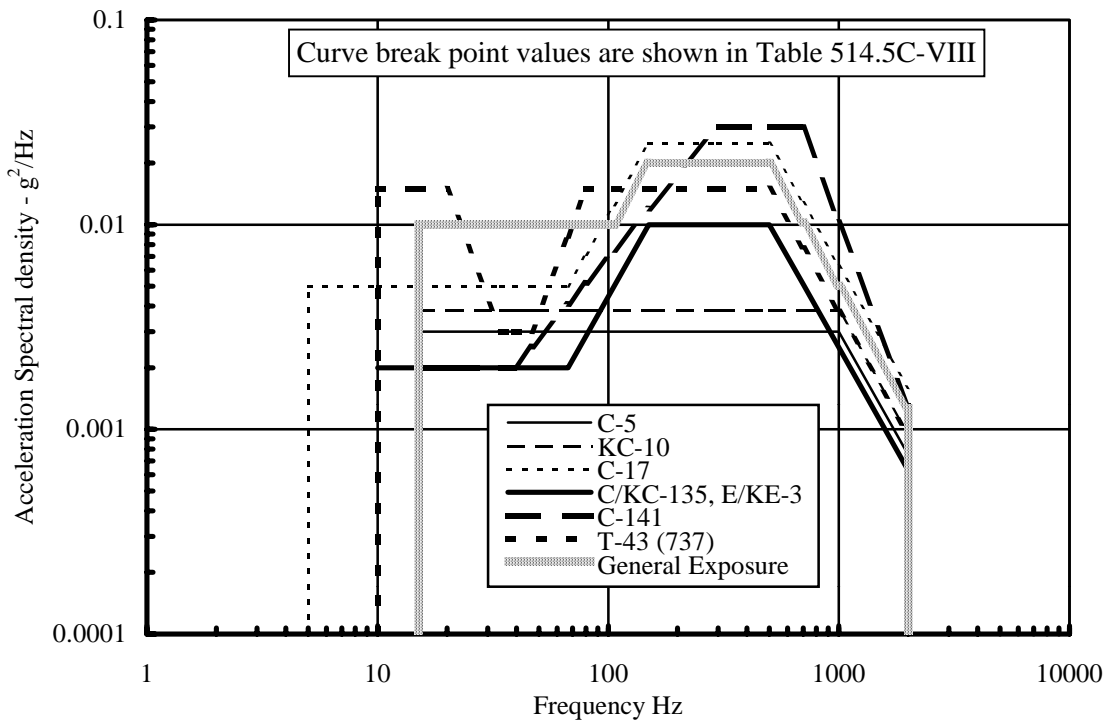

FIGURE 514.5C-6. Jet aircraft cargo vibration exposure.

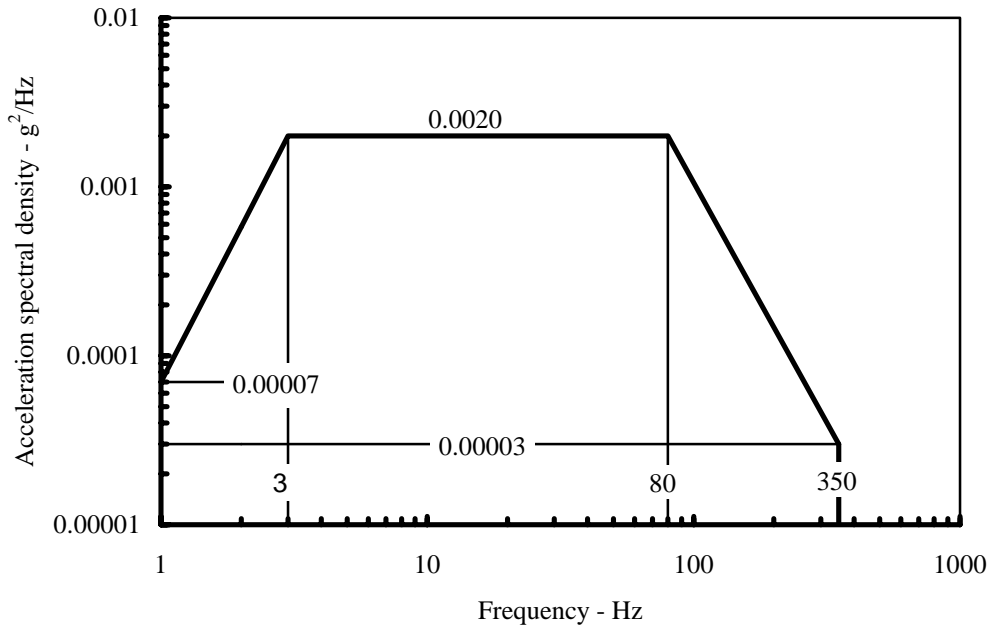

FIGURE 514.5C-7. Rail cargo vibration exposure.

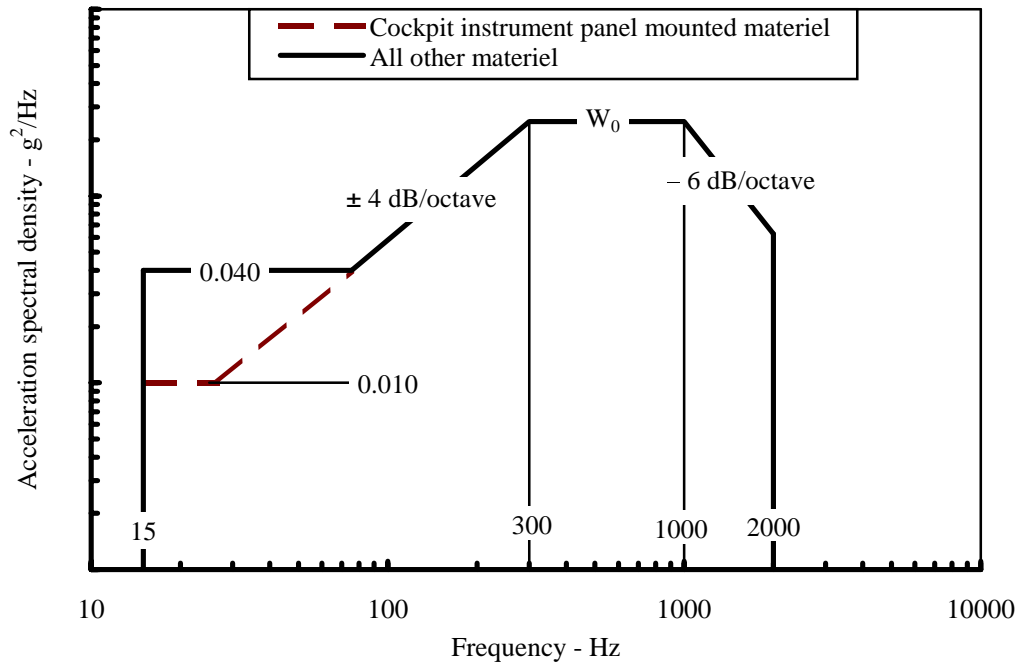

FIGURE 514.5C-8. Jet aircraft vibration exposure.

MIL-STD-810F
 1 January 2000
 ANNEX C

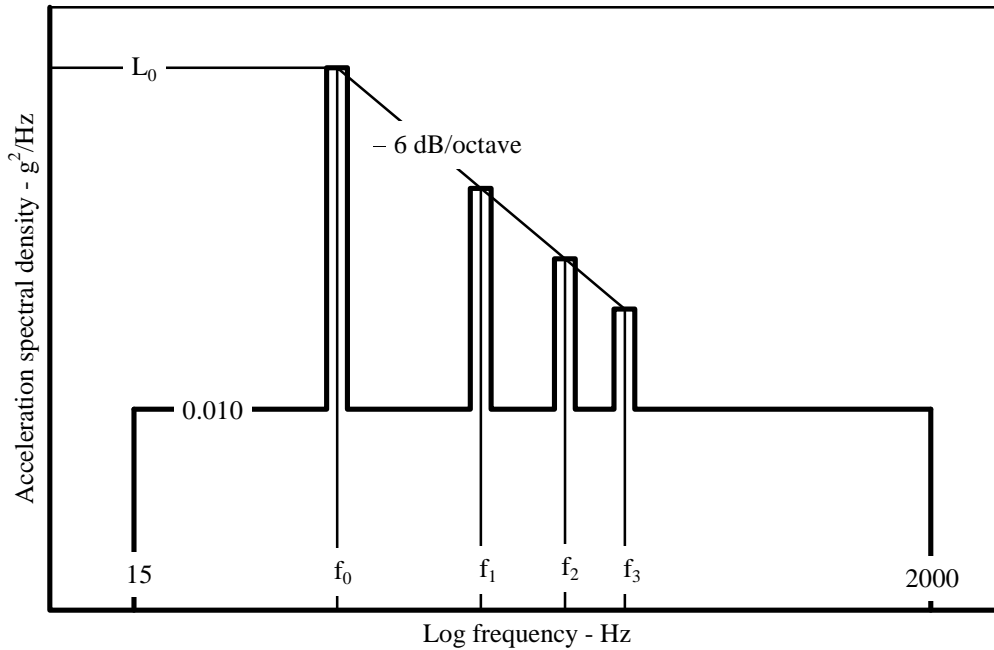

FIGURE 514.5C-9. Propeller aircraft vibration exposure.

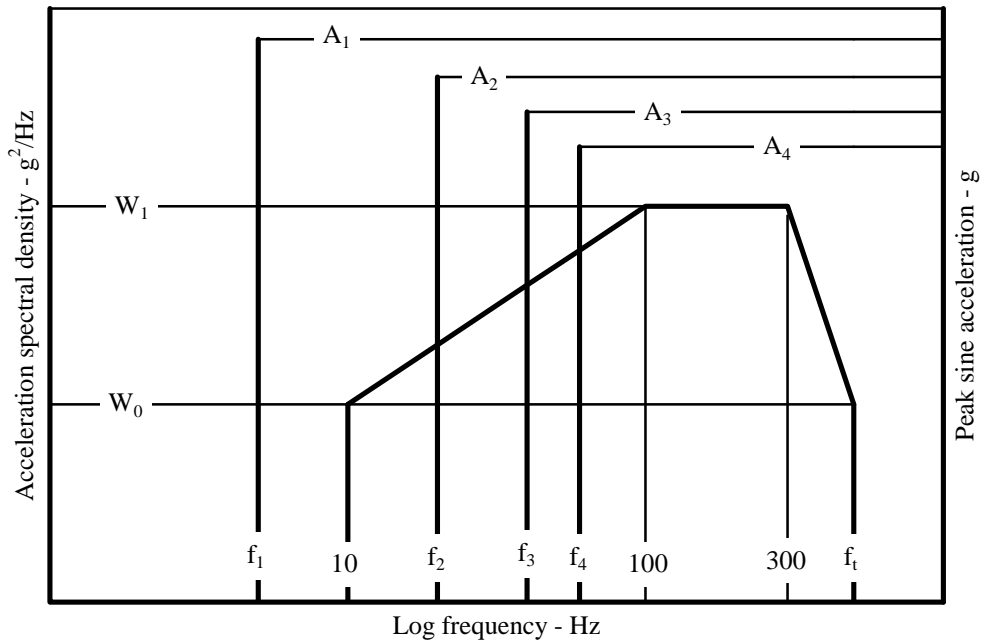

FIGURE 514.5C-10. Helicopter vibration exposure.

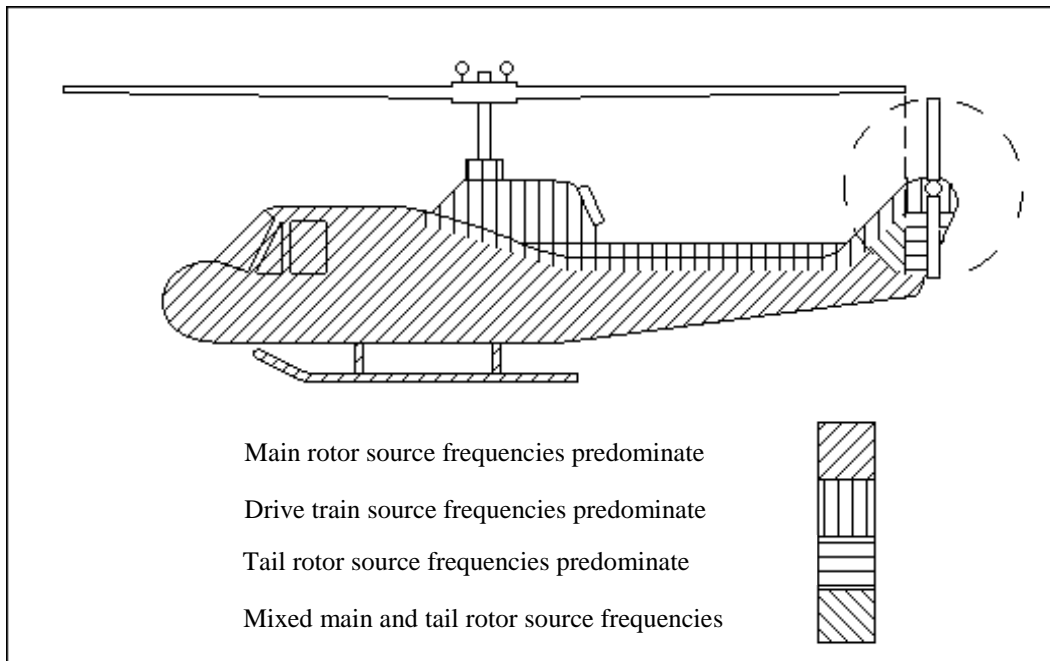

FIGURE 514.5C-11. Helicopter vibration zones.

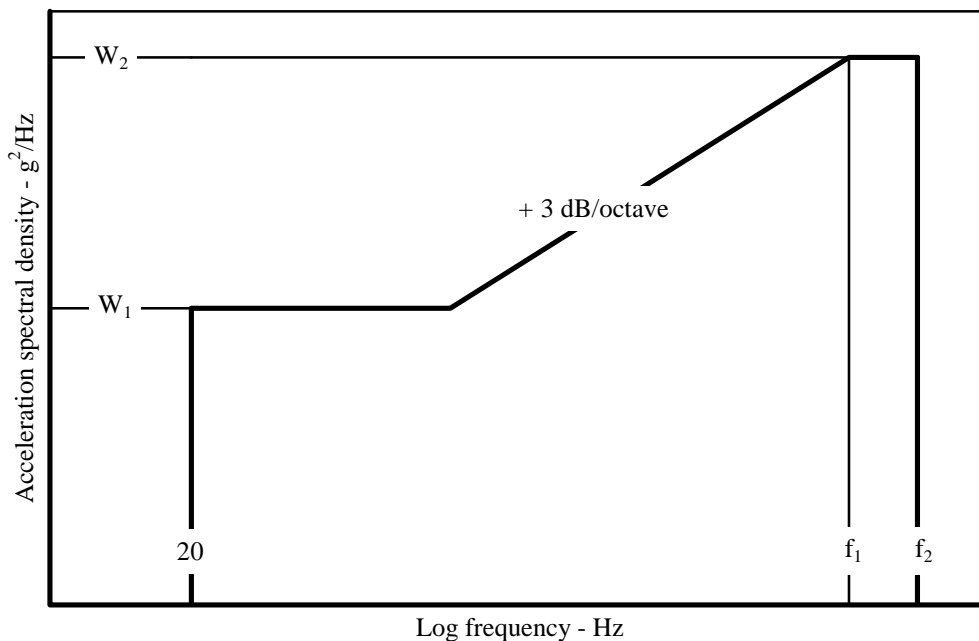

FIGURE 514.5C-12. Jet aircraft store vibration response.

MIL-STD-810F
 1 January 2000
 ANNEX C

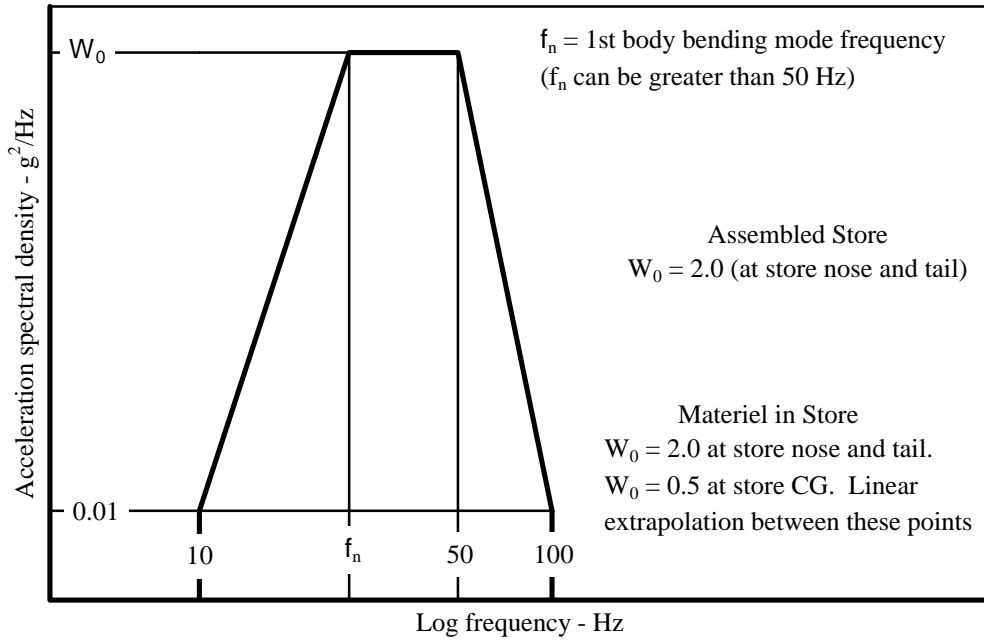

FIGURE 514.5C-13. Jet aircraft store buffet response.

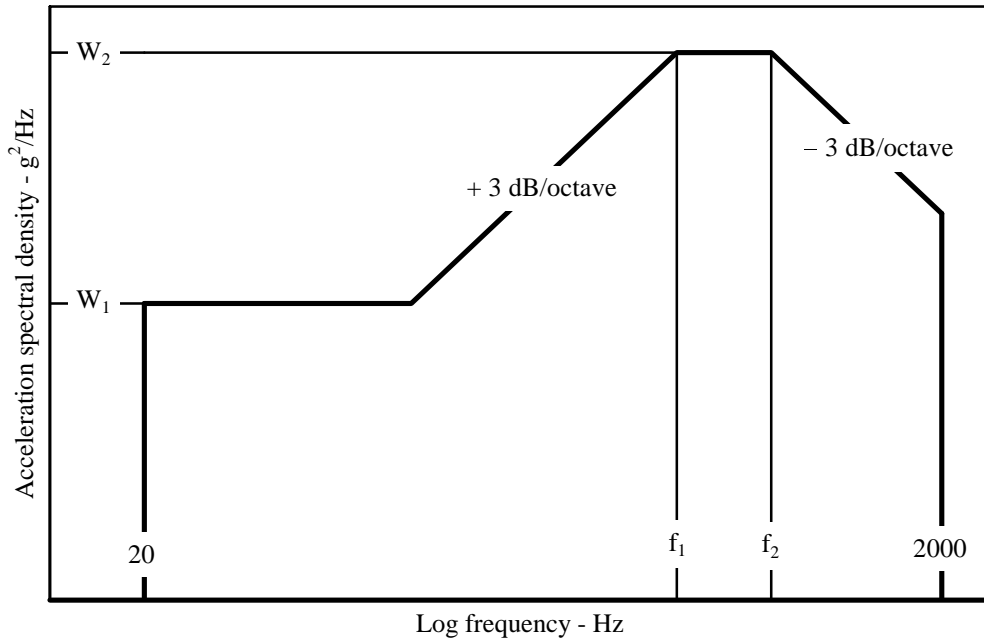

FIGURE 514.5C-14. Jet aircraft store equipment vibration exposure.

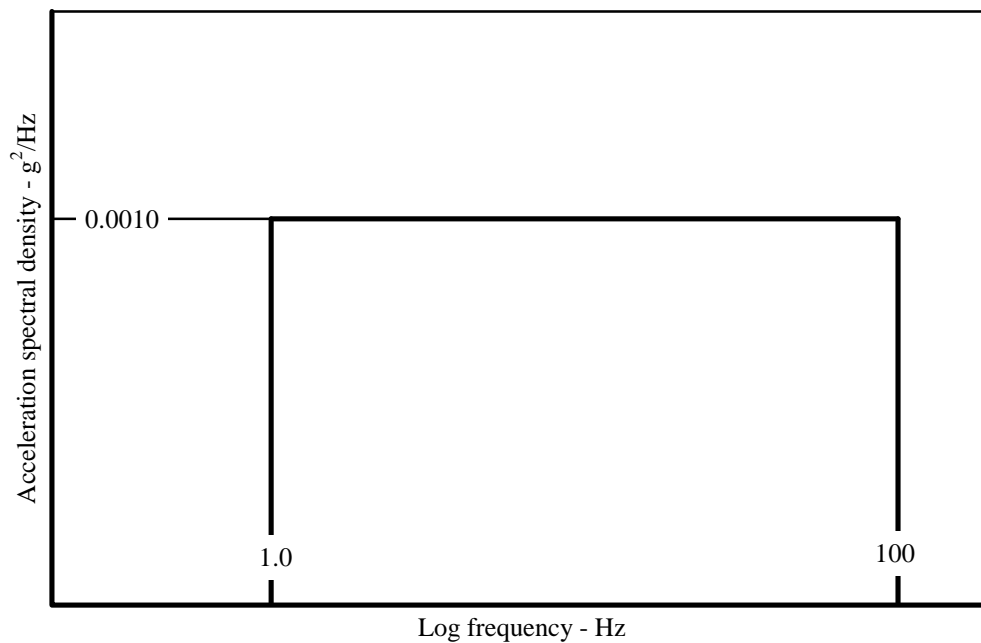

FIGURE 514.5C-15. Shipboard random vibration exposure.

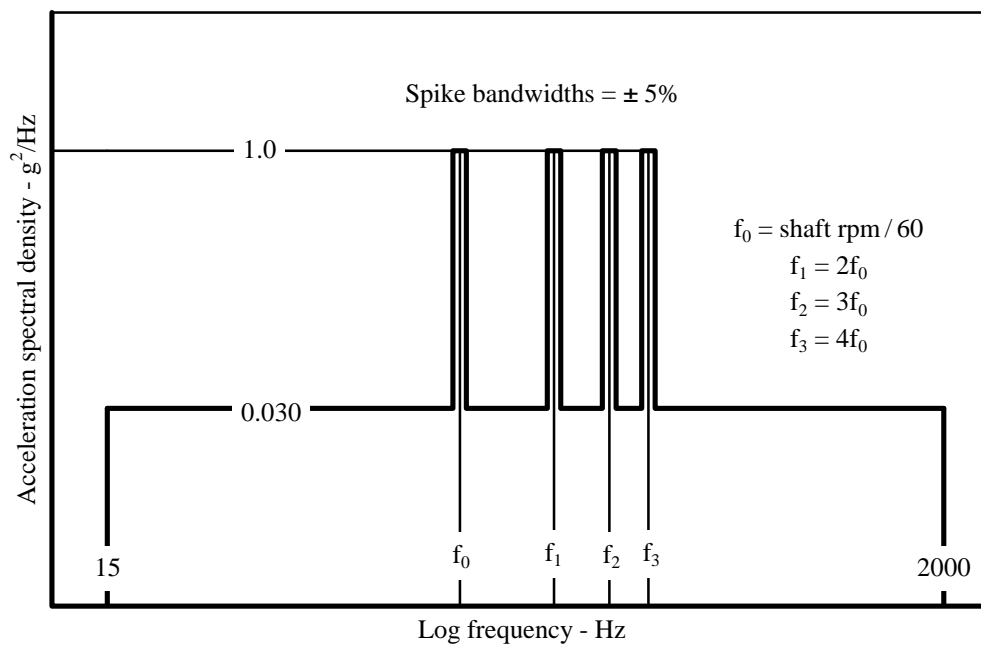

FIGURE 514.5C-16. Turbine engine vibration exposure.

MIL-STD-810F
 1 January 2000
 ANNEX C

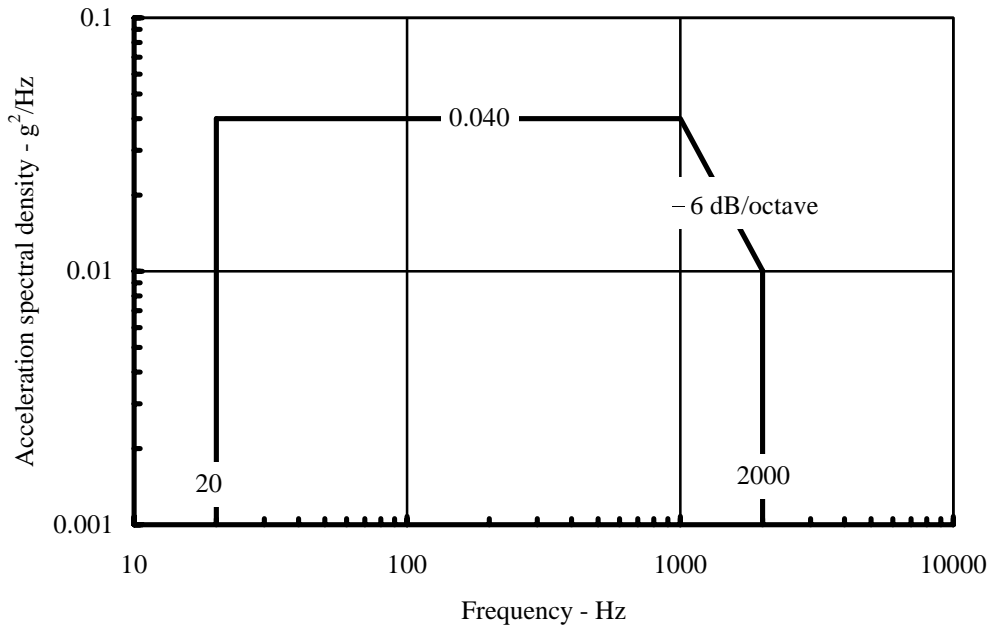

FIGURE 514.5C-17. General minimum integrity exposure.

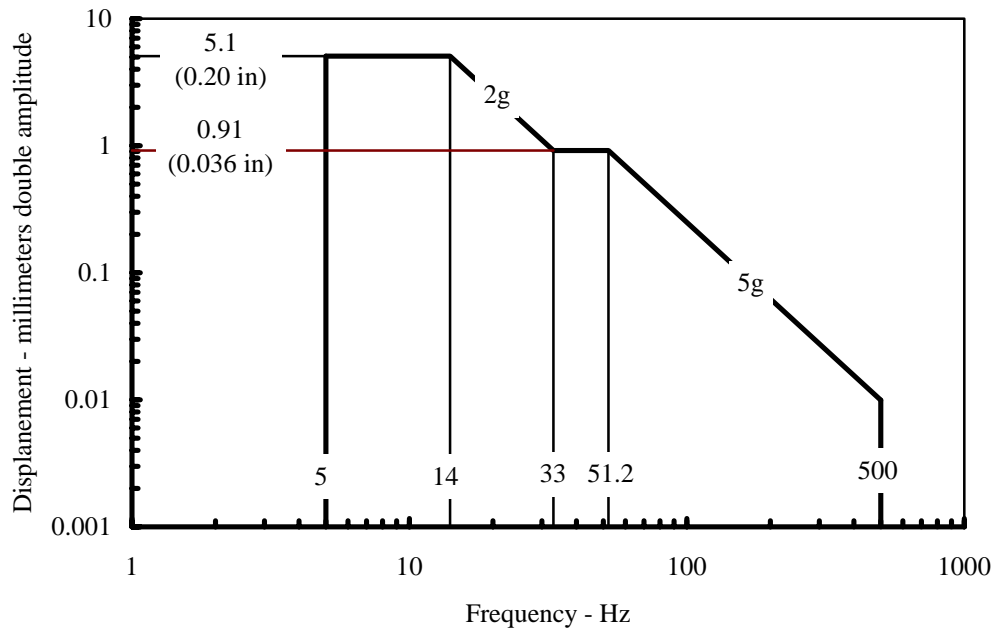

FIGURE 514.5C-18. Helicopter minimum integrity exposure.

METHOD 515.5

ACOUSTIC NOISE

NOTE: Tailoring is essential. Select methods, procedures, and parameter levels based on the tailoring process described in Part One, paragraph 4.2.2, and Appendix C. Apply the general guidelines for laboratory test methods described in Part One, paragraph 5 of this standard.

1. SCOPE.

1.1 Purpose.

The acoustic noise test is performed to demonstrate the adequacy of materiel to resist the specified acoustic environment without unacceptable degradation of its functional performance and/or structural integrity.

1.2 Application.

This test is applicable to systems, sub-systems, and units, hereafter called materiel, which must function and/or survive in a severe acoustic noise environment. This test is also applicable for materiel located where acoustic noise excitation is used in combination with or in preference to mechanical vibration excitation for the simulation of aerodynamic turbulence.

1.3 Limitations.

Technical limitations restrict production and control of laboratory acoustic environments. Thus laboratory acoustic fields can be significantly different from many of the real fluctuating pressure loadings classed as "acoustic." Consider these limitations when choosing a test type and test facility as well as in interpreting test results. For example, diffuse field acoustic noise (see paragraph 2.3.3.1) better represents acoustics in internal cavities where local reflection and re-radiation from vibrating structures predominate. For external skins exposed to aerodynamic turbulence or jet noise, grazing incidence acoustic noise (see paragraph 2.3.3.2) more closely represents flow/acoustic wave propagation along skin surfaces.

2. TAILORING GUIDANCE.

2.1 Selecting the Acoustic Noise Method.

After examining the requirements documents and applying the tailoring process in Part One of this standard to determine where acoustic noise may be encountered in the life cycle of the materiel, use the following to confirm the need for this method and to place it in sequence with other methods.

2.1.1 Effects of the acoustic noise environment.

The acoustic noise environment is produced by any mechanical or electromechanical device capable of causing large airborne pressure fluctuations. In general, these pressure fluctuations are of an entirely random nature over a large amplitude range (5000 Pa to 87000 Pa), and over a broad frequency band extending from 10 Hz to 10000 Hz. On occasion there may exist very high amplitude discrete frequency pressure fluctuations referred to as 'tones.' When pressure fluctuations impact materiel, generally, a transfer of energy takes place between the energy (in the form of fluctuating pressure) in the surrounding air to the strain energy in materiel. This transfer of energy will result in vibration of the materiel, in which case the vibrating materiel may re-radiate pressure energy, absorb energy in materiel damping, or transfer energy to components or cavities interior to the materiel. Because of the large amplitude and broad frequency range of the fluctuating pressure, measurement of materiel response is important. The following list is not intended to be all-inclusive, but it provides examples of problems that could occur when materiel is exposed to an acoustic noise environment.

MIL-STD-810F
1 January 2000

- a. Wire chafing
- b. Component acoustic and vibratory fatigue
- c. Component connecting wire fracture
- d. Cracking of printed circuit boards
- e. Failure of wave guide components
- f. Intermittent operation of electrical contacts
- g. Cracking of small panel areas and structural elements
- h. Optical misalignment
- i. Loosening of small particles that may become lodged in circuits and mechanisms
- j. Excessive electrical noise

2.1.2 Sequence among other methods.

- a. General. See Part One, paragraph 5.5.
- b. Unique to this method. Like vibration, the effects of acoustically induced stresses may affect materiel performance under other environmental conditions, such as temperature, humidity, pressure, electromagnetic, etc. When it is required to evaluate the effects of acoustic noise together with other environments and when a combined test is impractical, expose a single test item to all relevant environmental conditions in turn. Consider an order of application of the tests that is compatible with the Life Cycle Environmental Profile.

2.2 Selecting Procedures.

This method includes three acoustic noise test procedures. Determine which of the following procedure(s) to be used.

- a. Procedure I (Diffuse Field Acoustic Noise)
- b. Procedure II (Grazing Incidence Acoustic Noise)
- c. Procedure III (Cavity Resonance Acoustic Noise).

2.2.1 Procedure selection considerations.

The choice of test procedure is governed by the in-service acoustic environments and test purpose. Identify these environments from consideration of the Life Cycle Environmental Profile as described in Part One, Appendix A, Task 402. When selecting procedures, consider:

- a. The operational purpose of the materiel. From the requirements documents, determine the functions to be performed by the materiel in an acoustic noise environment, the total lifetime exposure to acoustic noise, and any limiting conditions.
- b. The natural exposure circumstances.
- c. The test data required to determine if the operational purpose (function and life) of the materiel has been met.
- d. The procedure sequence within the acoustic noise method. If more than one of the enclosed procedures is to be applied to the same test item, it is generally more appropriate to conduct the less damaging procedure first.

2.2.2 Difference among procedures.

While all procedures involve acoustic noise, they differ on the basis of how the acoustic noise fluctuating pressure is generated and transferred to the materiel.

- a. Procedure I – Diffuse Field Acoustic Noise. Procedure I has a uniform intensity shaped spectrum of acoustic noise that impacts all the exposed materiel surfaces.
- b. Procedure II – Grazing Incidence Acoustic Noise. Procedure II includes a high intensity, rapidly fluctuating acoustic noise with a shaped spectrum that impacts the materiel surfaces in a particular direction – generally along the long dimension of the materiel.
- c. Procedure III – Cavity Resonance Acoustic Noise. In Procedure III, the intensity and, to a great extent, the frequency content of the acoustic noise spectrum is governed by the relationship between the geometrical configuration of the cavity and the materiel within the cavity.

2.3 Determine Test Levels and Conditions.

2.3.1 General.

Having selected this method and relevant procedures (based on the materiel's requirements and the tailoring process), it is necessary to complete the tailoring process by selecting specific parameter levels and special test conditions/techniques for these procedures based on the requirements documents, Life Cycle Environmental Profile, Operational Environment Documentation (see Part One, figure 1-1), and information provided with this procedure. From these sources of information, determine test excitation parameters and the functions to be performed by the materiel in acoustic noise environments or following exposure to these environments.

2.3.2 Use of measured and related data.

Wherever possible, use specifically measured data to develop the test excitation parameters and obtain a better simulation of the actual environment. Obtain data at the materiel location, preferably on the specific platform or, alternatively, on the same platform type. In general, the data will be a function of the intended form of simulation. In some cases, only microphone sound pressure levels will be useful, and in other cases materiel acceleration response measurements will be useful.

2.3.3 Types of Acoustic Excitation.

2.3.3.1 Diffuse field acoustic noise.

A diffuse field is generated in a reverberation chamber. Normally wide band random excitation is provided and the spectrum is shaped. This test is applicable to materiel or structures that have to function or survive in an acoustic noise field such as that produced by aerospace vehicles, power plants and other sources of high intensity acoustic noise. Since this test provides an efficient means of inducing vibration above 100 Hz, the test may also be used to complement a mechanical vibration test, using acoustic energy to induce mechanical responses in internally mounted materiel. In this role the test is applicable to items such as installed materiel in airborne stores carried externally on high performance aircraft. However, since the excitation mechanism induced by a diffuse field is different from that induced by aerodynamic turbulence, when used in this role, this test is not necessarily suitable for testing the structural integrity of thin shell structures interfacing directly with the acoustic noise. A practical guideline is that acoustic tests are not required if materiel is exposed to broadband random noise at a sound pressure level less than 130 dB (ref 20 μ Pascal) overall, and if its exposure in every one Hertz band is less than 100 dB (ref 20 μ Pascal). A diffuse field acoustic test is usually defined by the following parameters.

- a. The spectrum levels.
- b. The frequency range.
- c. The overall sound pressure level.
- d. The duration of the test.

MIL-STD-810F
1 January 2000

2.3.3.2 Grazing incidence acoustic noise.

Grazing incidence acoustic noise is generated in a duct, popularly known as a progressive wave tube. Normally, wide band random noise with a shaped spectrum is directed along the duct. This test is applicable to assembled systems that have to operate or survive in a service environment of pressure fluctuations over the surface, such as exist in aerodynamic turbulence. These conditions are particularly relevant to aircraft panels, where aerodynamic turbulence will exist on one side only, and to externally carried stores subjected to aerodynamic turbulence excitation over their total external exposed surface. In the case of a panel, the test item will be mounted in the wall of the duct so that grazing incidence excitation is applied to one side only. An aircraft carried store such as a missile will be mounted co-axially within the duct such that the excitation is applied over the whole of the external surface. A grazing incidence acoustic noise test is usually defined by the following parameters:

- a. The spectrum levels.
- b. The frequency range.
- c. The overall sound pressure level.
- d. The duration of the test.

2.3.3.3 Cavity resonance.

A resonance condition is generated when a cavity, such as that represented by an open weapons bay on an aircraft, is excited by the airflow over it. This causes oscillation of the air within the cavity at frequencies dependent upon the cavity dimensions and the aerodynamic flow conditions. In turn, this can induce vibration of the structure and of components in and near the cavity. The resonance condition can be simulated by the application of a sinusoidal acoustic source, tuned to the correct frequency of the open cavity. The resonance condition will occur when the control microphone response reaches a maximum in a sound field held at a constant sound pressure level over the frequency range. A cavity resonance test is defined by the following parameters:

- a. The noise frequency.
- b. The overall sound pressure level within the cavity.
- c. The duration of the test.

2.3.3.4 Additional technical guidance.

Additional guidance is given in Annex B.

2.4 Test Item Configuration.

(See Part One, paragraph 5.8.) Where relevant, function the test item and measure and record performance data during each test phase and/or each acoustic level applied.

3. INFORMATION REQUIRED.

The following information is necessary to properly conduct the acoustic test.

3.1 Pretest.

- a. General. See the information listed in Part One, paragraphs 5.7, 5.8, 5.9, 5.11 and 5.12, and Part One, Appendix A, Tasks 405 and 406 of this standard.
- b. Specific to this method.
 - (1) Establish test levels and durations using projected Life Cycle Environmental Profiles, available data or data acquired directly from an environmental data-gathering program. When these data are not available, use the guidance on developing initial test severities in Annex A. Consider these overall sound pressure levels (OASPL) as initial values until measured data are obtained. The test selected

may not necessarily be an adequate simulation of the complete environment and consequently a supporting assessment may be necessary to complement the test results.

- (2) If the test item is required to operate during the test; the operating checks required are pretest, during the test, and post test. For the pre- and post test checks, specify whether they are performed with the test item installed in the test facility. Define the details required to perform the test, including the method of attachment or suspension of the test item, the effect of gravity and any consequent precautions. Identify the control and monitor points, or a procedure to select these points. Define test interruption, test completion and failure criteria.

3.2 During Test.

- a. General. See the information listed in Part One, paragraph 5.10, and in Part One, Appendix A, Tasks 405 and 406.
- b. Specific to this method.
 - (1) Collect outputs of microphones, test control averages, test item operating parameters, and any other relevant transducers at appropriate test times.
 - (2) Collect log/records of materiel operating parameters.
 - (3) Give particular attention to interactions of the input excitation (diffuse and uniform, directional or tonal).
 - (4) Record transient behavior in the input representing a test anomaly.

3.3 Post Test.

- a. General. See the information listed in Part One, paragraph 5.13, and in Part One, Appendix A, Tasks 405 and 406 of this standard.
- b. Specific to this method. Identify any indication of failure under specified failure criteria. Account for tolerance excesses when testing large materiel, the number of simultaneous test items in Procedure I, and any other environmental conditions at which testing was carried out, if other than standard laboratory conditions.

4. TEST PROCESS.

4.1 Test Facility.

Ensure the apparatus used to perform the acoustic test has sufficient capacity to adequately reproduce the input requirements. Diffuse acoustic field apparatus that produce uniform acoustic fields above 165 dB are rare. For high level acoustic input (above 165 dB), consider testing using grazing incidence acoustic noise. For measured data that indicates tonal input, consider a facility that can be configured to produce a cavity resonance condition.

4.2 Control.

The control strategy depends upon the type of test and the size of the materiel.

4.2.1 Control options.

4.2.1.1 Single point noise control.

Define the single point, providing an optimum control position in the chamber or progressive wave tube.

MIL-STD-810F
1 January 2000

4.2.1.2 Multiple point noise control.

Select the control points to define a controlled volume within the reverberation chamber. Base control upon the average of the sound spectrum levels at each microphone. Where the range of measurements at the monitoring positions does not exceed 5 dB (OASPL) a simple arithmetic average of the sound spectrum levels (in dB) may be used. For a range of 5 dB or greater, use an average of the non-logarithmic sound spectrum levels (i.e., μPa or microbar), then convert to dB.

4.2.1.3 Vibration response control.

Where it is necessary to achieve a given vibration acceleration response on the test item, adjust the acoustic test spectrum to achieve the required response which may be monitored at either a single point or as the average from multiple monitoring points. Refer to method 514.5 for further guidance.

4.2.2 Control methods.

Control can be by either open or closed loop. Open loop control is adequate for progressive wave tubes and for small chambers having a single noise source. Closed loop control is more effective for large chambers having multiple noise sources that cover different bands in the test frequency range.

4.2.3 Overall accuracy of control.

Ensure the uncertainty of measurement of the total measurement system, including statistical errors, does not exceed one-third of the specified tolerance for the overall sound pressure level.

4.2.4 Calibration and tolerance.

Test tolerances are given in table 515.5-I. Ensure the calibration and test tolerance procedures for test control are generally consistent with the guidance provided in Part One, paragraphs 5.3.2 and 5.2, respectively.

4.2.5 Test interruption.

- a. General. See Part One, paragraph 5.11 of this standard.
- b. Specific to this method. Interruption of an acoustic noise test is unlikely to generate any adverse effects. Normally, continue the test from the point of interruption.

4.3 Instrumentation.

Ensure that all test environment monitoring instrumentation and test item function monitoring instrumentation is consistent with the calibration and test tolerance procedures, and are generally consistent with the guidance provided in Part One, paragraphs 5.3.2 and 5.2, respectively.

4.4 Data Analysis.

Detailed data analysis for verification of the input to the test item, i.e., the acoustic field and the response monitoring of the test item, are to be in accordance with the test plan.

TABLE 515.5-I. Test tolerances.

| PARAMETER | TOLERANCE |
|---|------------------------------------|
| Overall sound pressure level averaged over all control microphones, ref specified overall sound pressure level | +3dB -1dB |
| Overall sound pressure level at each control microphone, ref specified overall sound pressure level | +4dB -2dB |
| Averaged test spectrum from all control microphones at levels above -15dB in 1/3 octave bands, ref specified 1/3 octave band sound pressure levels. | ±4dB |
| Averaged test spectrum from all control microphones at levels below -15dB and above -25dB in 1/3 octave bands, ref specified 1/3 octave band sound pressure levels. | ±6dB |
| Averaged test spectrum from all control microphones at levels -25dB and below in 1/3 octave bands, ref specified 1/3 octave band sound pressure levels. | ±10dB |
| Duration | ±5% or ±1 min whichever is less |

4.5 Test Conditions.**4.5.1 Installation of the test item.****4.5.1.1 Diffuse field acoustic noise.**

Suspend the test item (or as otherwise mounted) in a reverberation chamber on an elastic system in such a manner that all appropriate external surfaces are exposed to the acoustic field and no surface is parallel to a chamber surface. Ensure the resonance frequency of the mounting system with the specimen is less than 25 Hz or 1/4 of the minimum test frequency, whichever is less. If cables, pipes etc., are required to be connected to the test item during the test, arrange them to provide similar restraint and mass as in service. Locate a microphone in proximity to each major different face of the test item at a distance of 0.5 meter from the face, or midway between the center of the face and the chamber wall, whichever is smaller. Average the outputs from these microphones to provide a single control signal. Where the chamber is provided with a single noise injection point, place one microphone between the test item and the chamber wall furthest from the noise source. The orientation of the microphones in such a facility is not critical, but do not set the microphone axes normal to any flat surface. Calibrate the microphones for random incidence.

4.5.1.2 Grazing incidence acoustic noise.

Mount test items such as panels in the wall of the duct such that the required test surfaces are exposed to the acoustic excitation. Ensure this surface is flush with the inner surface of the duct to prevent the introduction of cavity resonance or local turbulence effects. Suspend test items (such as aircraft external stores) centrally within the duct, on an elastic support. Orient the test item such that the appropriate surfaces are subjected to progressive acoustic waves. For example, orient an aircraft external store parallel to the duct centerline so that the acoustic waves sweep the length of the store. Ensure the rigid body modes of the test item are lower than 25 Hz or 1/4 of the lowest test frequency, whichever is less. Ensure that no spurious acoustic or vibratory inputs are introduced by the test support system or by any ancillary structure. Mount the microphone(s) for control and monitoring of test conditions in the duct wall opposite the test panel. Select other positions within the duct assuming the microphone is positioned so that it responds to only grazing incidence waves and that the necessary corrections are applied to the measured level. Calibrate the microphones for grazing incidence.

MIL-STD-810F
1 January 2000

4.5.1.3 Cavity resonance acoustic noise.

Suspend the test item (or as otherwise mounted) in a reverberation chamber such that only that part of the cavity to be tested is exposed to the direct application of acoustic energy. Protect all other surfaces so that their level of acoustic excitation is reduced by 20 dB. Do not use protective coverings that provide any additional vibration damping to the structure. Do not locate the microphone for control of the test within the cavity to be tested.

4.5.2 Effects of gravity.

Tests will normally be carried out with the test item mounted in the correct attitude, unless it is shown that the performance of the test item is not affected by gravity.

4.5.3 Preparation for test.

4.5.3.1 Preconditioning.

Unless otherwise specified, allow the test item to stabilize at ambient conditions.

4.5.3.2 Inspection and performance checks.

Inspection and performance checks may be carried out before and after testing. Define the requirements for these checks in the test plan. If these checks are required during the test sequence, specify the time intervals at which they are required.

4.5.4 Procedures.

In the test plan stipulate whether the test item is or is not to be operating during the test.

4.5.4.1 Procedure 1 - Diffuse field acoustic noise testing.

- Step 1. Install the test item in the reverberation chamber in accordance with paragraph 4.5.1.1.
- Step 2. Select microphone positions for control, monitoring, and control strategy in accordance with paragraph 4.5.1.1.
- Step 3. When using open loop control, remove the test item and confirm the specified overall sound pressure level and spectrum can be achieved in an empty chamber, then replace the test item in the chamber.
- Step 4. Precondition the test item in accordance with paragraph 4.5.3.1.
- Step 5. Conduct initial checks in accordance with paragraph 4.5.3.2.
- Step 6. Apply the test spectrum for the specified time. If required, carry out inspections and performance checks in accordance with paragraph 4.5.3.2.
- Step 7. Record the test acoustic field at each microphone, any average used in test control, and other pertinent transducer outputs. Make the recordings at the beginning, midpoint, and end of each test run. Where test runs are longer than one hour, record every one-half hour.
- Step 8. Carry out the final inspection.
- Step 9. Remove the test item from the chamber.
- Step 10. In all cases, record the information required.

4.5.4.2 Procedure 2 - Grazing incidence acoustic noise testing.

- Step 1. Install the test item in accordance with paragraph 4.5.1.2.
- Step 2. Select microphone positions for control, monitoring, and control strategy in accordance with 4.5.1.2.
- Step 3. Precondition the test item in accordance with 4.5.3.1.

- Step 4. Conduct initial checks in accordance with 4.5.3.2.
- Step 5. Apply the test spectrum for the specified time. If required, carry out inspections and performance checks in accordance with paragraph 4.5.3.2.
- Step 6. Record the test acoustic field at each microphone, any average used in test control, and other pertinent transducer outputs. Make recordings at the beginning, end and midpoint of each test run. Where test runs are longer than one hour, record every one-half hour.
- Step 7. Carry out the final inspection.
- Step 8. Remove the test item from the duct.
- Step 9. In all cases, record the information required.

4.5.4.3 Procedure 3 - Cavity resonance acoustic noise testing.

- Step 1. Install the test item into the chamber in accordance with paragraph 4.5.1.3.
- Step 2. Locate the control microphone in accordance with paragraph 4.5.1.2.
- Step 3. Precondition the test item in accordance with paragraph 4.5.3.1.
- Step 4. Conduct initial checks in accordance with paragraph 4.5.3.2.
- Step 5. Apply the sinusoidal acoustic excitation at the required frequencies (see table 5.5.5A-II). Adjust the test parameters to the specified levels and apply for the specified time. If required, carry out inspections and performance checks in accordance with paragraph 4.5.3.2.
- Step 6. Record the test acoustic field at each microphone, any average used in test control, and other pertinent transducer outputs. Make recordings at the beginning, midpoint, and end of each test run. Where test runs are longer than one hour, record every one-half hour.
- Step 7. Perform the final inspection.
- Step 8. Remove the test item from the chamber.
- Step 9. In all cases, record the information required.

5. ANALYSIS OF RESULTS.

Refer to Part One, paragraphs 5.14 and 5.17, and Part One, Annex A, Tasks 405 and 406.

6. REFERENCE/RELATED DOCUMENTS.

- a. NATO STANAG 4370, Environmental Testing.
- b. NATO Allied Environmental Engineering and Test Publication (AECTP) 400, Mechanical Environmental Testing.

MIL-STD-810F
1 January 2000

THIS PAGE INTENTIONALLY BLANK

ANNEX A

GUIDANCE FOR INITIAL TEST SEVERITY

1. BROAD BAND RANDOM AND INCIDENCE NOISE TESTING.

1.1 Overall Sound Pressure Level (OASPL).

From the known area of operation for the materiel, the test overall sound pressure level and duration may be obtained from table 515.5A-I.

1.2 Test Spectrum.

The applied test spectrum associated with these levels is shown on figure 515.5A-1 with breakpoints defined in table 515.5A-III. Achieve the test spectrum while maintaining the test parameters within the tolerances given in table 515.5-I.

1.3 Simulation of Aerodynamic Turbulence.

Where a broadband noise test is required for the simulation of aerodynamic turbulence, derive the test levels and durations in conjunction with those for the complementary mechanical test.

2. CAVITY RESONANCE TESTING.

For cavity resonance testing, the sound pressure level B_o , frequencies f_N and duration T will be as calculated or defined in table 515.5A-II.

3. EXTERNAL STORES TESTING.

3.1 Test Spectrum.

A typical store profile is shown on figure 515.5A-2. The applied test spectrum is shown on figure 515.5A-3.

3.2 Test Parameters.

For acoustic testing of external stores, the associated levels and definitions are shown in table 515.5A-IV.

MIL-STD-810F
1 January 2000
ANNEX A

TABLE 515.5A-I. Overall sound pressure levels and durations.

| TYPICAL APPLICATION | TEST LEVEL (OASPL) dB | DURATION (Min) |
|--|-----------------------|----------------|
| Transport aircraft at locations not close to jet exhausts | 130 | 30 |
| Transport aircraft, in internal materiel bays close to jet exhausts | 140 | 30 |
| High performance aircraft at location not close to jet exhausts | 145 | |
| High performance aircraft in internal materiel bays close to jet exhausts | 150 | 30 |
| Air-to-air missile on medium performance aircraft (i.e., $q < 1200$ psf (57456 Pa)). | 150 | 30 |
| Air-to-ground missile on medium performance aircraft (i.e., $q < 1200$ psf (57456 Pa)). | 150 | 15 |
| Ground materiel in enclosed engine runup areas | 135 | 30 |
| High performance aircraft in internal materiel bays close to reheat exhaust and gun muzzles or in nose cones | 160 | 30 |
| Airborne rocket most locations but excluding booster or engine bays | 140 | 8 |
| Air-to-air missile on high performance aircraft (i.e., $q < 1800$ psf (86184 Pa)). | 165 | 30 |
| Air-to-ground missile on high performance aircraft (i.e., $q < 1800$ psf (86184 Pa)). | 165 | 15 |
| Airborne rocket booster or engine bays | 140 | 8 |

TABLE 515.5A-II. Cavity resonance test conditions.

| |
|--|
| <p><u>Test level</u></p> $B_0 = 20 \log(q) + 76.4 \text{ dB} \quad (\text{ref } 20 \text{ } \mu\text{Pa})$ $f_N = \frac{6.13 \left[(N - 0.25) \left(2.4 - \frac{M^2}{2} \right) \right]^{0.5}}{0.57(L)(C) + \left(2.4 - \frac{M^2}{2} \right)^{0.5}} \text{ Hz}$ <p>Test duration: T=1 hour per resonance frequency</p> |
| <p><u>Definitions</u></p> <p>f_N = Resonance frequency for the N^{th} mode (where $N=1, 2, 3, \dots$) up to 500 Hz (where $f_1 > 500$ Hz use only this mode)</p> <p>N = Mode number</p> <p>C = Speed of sound at altitude of flight (m/s)</p> <p>L = Length/radius of opening exposed to air stream (m). Identify a second set of resonance frequencies by using the distance parameter L as the depth of the cavity.</p> <p>M = Mach number</p> <p>q = Flight dynamic pressure when cavity is open (Pa). (See method 514.5 for guidance on defining "q.")</p> |

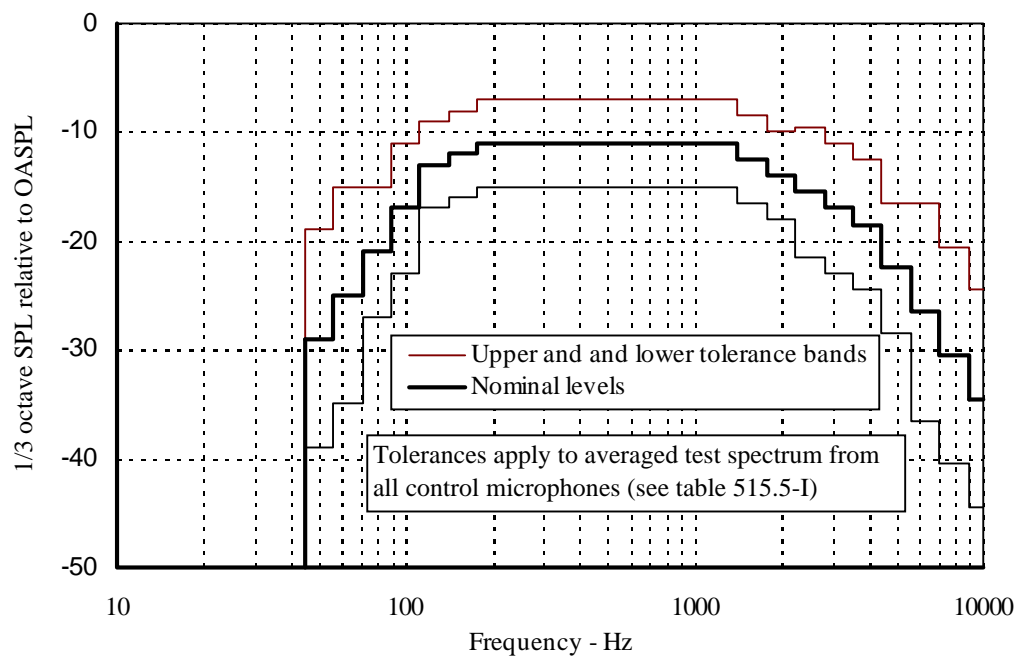

FIGURE 515.5A-1. Applied test spectrum.

TABLE 515.5A-III. 1/3 Octave band levels for figure 515.5A-1.

| 1/3 octave center frequency Hz | Upper tolerance limit dB | Nominal level dB | Lower tolerance limit dB | 1/3 octave center frequency Hz | Upper tolerance limit dB | Nominal level dB | Lower tolerance limit dB |
|--------------------------------|--------------------------|------------------|--------------------------|--------------------------------|--------------------------|------------------|--------------------------|
| 50 | -19 | -29 | -39 | 800 | -7 | -11 | -15 |
| 63 | -15 | -25 | -35 | 1000 | -7 | -11 | -15 |
| 80 | -15 | -21 | -27 | 1250 | -7 | -11 | -15 |
| 100 | -11 | -17 | -23 | 1600 | -8.5 | -12.5 | -16.5 |
| 125 | -9 | -13 | -17 | 2000 | -10 | -14 | -18 |
| 160 | -8 | -12 | -16 | 2500 | -9.5 | -15.5 | -21.5 |
| 200 | -7 | -11 | -15 | 3150 | -11 | -17 | -23 |
| 250 | -7 | -11 | -15 | 4000 | -12.5 | -18.5 | -24.5 |
| 315 | -7 | -11 | -15 | 5000 | -16.5 | -22.5 | -28.5 |
| 400 | -7 | -11 | -15 | 6300 | -16.5 | -26.5 | -36.5 |
| 500 | -7 | -11 | -15 | 8000 | -20.5 | -30.5 | -40.5 |
| 630 | -7 | -11 | -15 | 10000 | -24.5 | -34.5 | -44.5 |

MIL-STD-810F
 1 January 2000
 ANNEX A

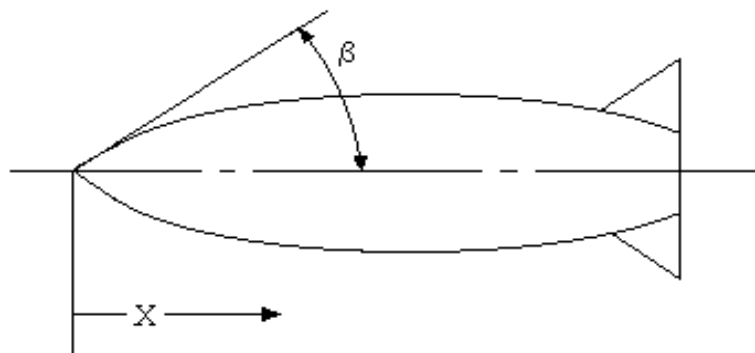

FIGURE 515.5A-2. Typical store profile.

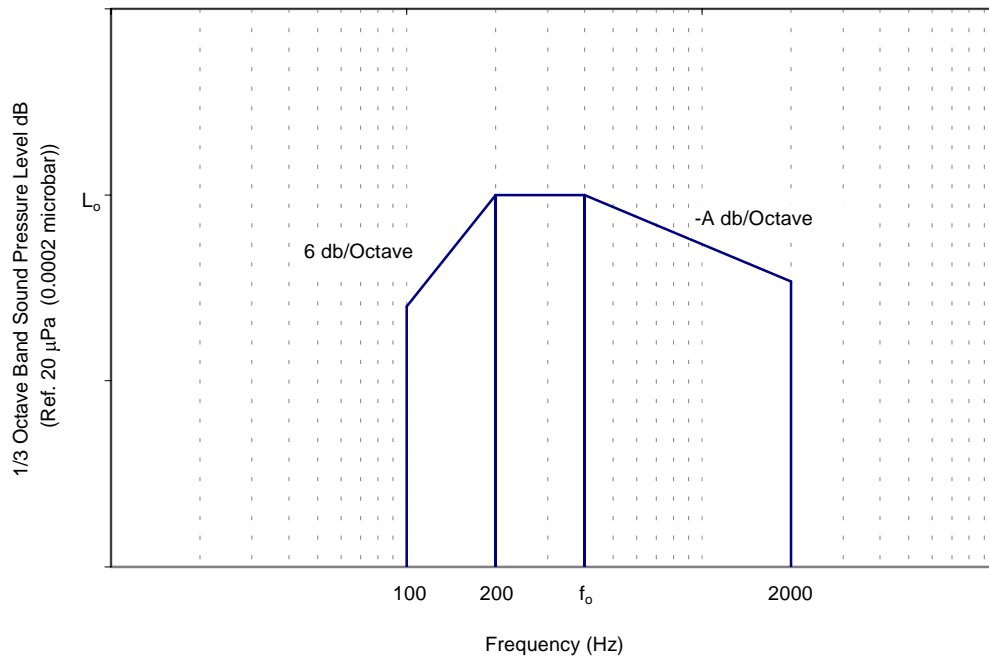

FIGURE 515.5A-3. One-third octave band spectrum for assembled externally carried aircraft stores.

TABLE 515.5A-IV. Suggested acoustic test levels for assembled externally carried aircraft stores.

| | | |
|--|------|-------------------------|
| A = 6 dB/Octave when $f_0 > 400$ Hz | | |
| A = 2 dB/Octave when $f_0 \leq 400$ Hz | | |
| Functional Test | | |
| $L_0 = 20 \log (q_1) + 11 \log (X) + 7 \log (1 - \cos \beta) + G + H$ | (dB) | (see Notes 1, 5, 6, 7.) |
| $f_0 = 600 \log (X/R) + C$ | | (see Notes 2, 3.) |
| Endurance Test | | |
| $L_0 = 20 \log (q_2/q_1) + 2.5 \log (N/3T) + \text{functional level}$ | (dB) | (see Notes 1, 5, 6, 7.) |
| $f_0 = 600 \log (X/R) + C$ | | (see Notes 2, 3.) |
| Definitions | | |
| $q_1 = \text{captive flight dynamic pressure (lbs/ft}^2) \leq 1800$ | | |
| $q_2 = 1200 \text{ psf or maximum captive flight dynamic pressure (whichever is lower) (lbs/ft}^2)$ | | |
| $N = \text{maximum number of anticipated service missions (minimum } N = 3)$ | | |
| $R = \text{local radius of store in inches}$ | | (see Note 4.) |
| $X = \text{distance from nose of store along axis of store in inches}$ | | |
| $T = \text{test time in hours (minimum } T = 1 \text{ hour unless otherwise specified)}$ | | |
| $C = -200 \text{ for locations (1) within one (D) of the aft end of the store, or (2) aft of a flow reentry point.}$ (See Note 8); $= 400 \text{ for all other locations}$ | | |
| $D = \text{maximum store diameter in inches}$ | | (see Note 4.) |
| $\beta = \text{local nose cone angle at } X \text{ equals } 1/\tan \beta = (R/X)$ | | (see figure 515.5A-2) |
| $G = 72 \text{ unless measured data shows otherwise}$ | | |
| $E = 96 \text{ unless measured data shows otherwise}$ | | |
| $F = 84 \text{ unless measured data shows otherwise}$ | | |
| $H = 0 \text{ for } 0.85 < M < 0.95;$ $= -3 \text{ dB for all other values of } M$ | | |
| $M = \text{Mach number}$ | | |

MIL-STD-810F
1 January 2000
ANNEX A

TABLE 515.5A-IV. Suggested acoustic test levels for assembled externally carried aircraft stores (continued).

Representative parametric values to be used for captive flight when specific parameters are not available:

| Store Type | N Endurance | Local Nose Cone Angle Degrees | q max | f ₀ Nose Section | f ₀ Middle Section | f ₀ Aft Section |
|-----------------------|-------------|-------------------------------|-------|-----------------------------|-------------------------------|----------------------------|
| Air-to-Air Missile | 100 | 69 | 1600 | 500 | 1000 | 500 |
| Air-to-Ground Missile | 3 | 12 | 1600 | 800 | 630 | 630 |
| Instrument Pod | 500 | 69 | 1800 | 500 | 1000 | 500 |
| Reusable Dispenser | 50 | 11 | 1200 | 630 | 1000 | 400 |
| Demolition Bomb | 3 | 24 | 1200 | 500 | 1000 | 630 |
| Flat Nose Store | 3 | 90 | 1200 | 400 | 630 | 315 |

Notes:

1. Raise computed L₀ level by 3 dB for a store carried in a TER cluster rack; by 5 dB for an MER cluster rack.
2. If calculated f₀ is above 2000 Hz, use upper frequency limit of 2000 Hz. If calculated f₀ is below 200 Hz, use 200 Hz.
3. Round off f₀ upward to a one-third octave center band frequency.
4. For stores that do not have circular cross-sections, use the radius in the formulas that is the radius of the circle that circumscribes the cross-section of the store.

5. For locations on flat nose stores ($80^\circ \leq \beta \leq 90^\circ$) where $X < 100$:

$$\text{Functional test: } L_0 = 20 \log (q_1) - 6 \log (X) + E + H$$

$$\text{Endurance test: } L_0 = 20 \log (q_2) - 6 \log (X) + E + 2.5 \log (N/3T) + H$$

6. For long cylindrical section $> 2D$, use for locations more than one D aftward into the cylindrical section:

$$\text{Functional test: } L_0 = 20 \log (q_1) + F + H$$

$$\text{Endurance test: } L_0 = 20 \log (q_2) + F + 2.5 \log (N/3T) + H$$

7. For changing radius section either aft of a long cylindrical section or when $X > 100$ on a flat nose store, redefine X so that $X = 1$ at the beginning of this section.

$$\text{Functional test: } L_0 = 20 \log (q_1) + 11 \log (X) + F + H$$

$$\text{Endurance test: } L_0 = 20 \log (q_2) + 11 \log (X) + F + 2.5 \log (N/3T) + H$$

8. A flow reentry point is the furthest upstream (forward) point of a store cross section change which results in a flow component toward the store centerline as opposed to flow away from or parallel to the store centerline.

ANNEX B

ADDITIONAL TECHNICAL GUIDANCE

1. REVERBERATION CHAMBERS.

1.1 A reverberation chamber is basically a cell with hard, acoustically reflective walls. When noise is generated in this room, the multiple reflections within the main volume of the room cause a uniform diffuse noise field to be set up. The uniformity of this field is disturbed by three main effects.

- a. At low frequencies, standing modes are set up between parallel walls. The frequency below which these modes become significant is related to the chamber dimensions. Small chambers, below about 100 cubic meters in volume, are usually constructed so that no wall surfaces are parallel to each other in order to minimize this effect.
- b. Reflections from the walls produce higher levels at the surface. The uniform noise field therefore only applies at positions within the central volume of the chamber; do not position test items within about 0.5 m of the walls.
- c. The size of the test item can distort the noise field if the item is large relative to the volume of the chamber. It is normally recommended that the volume of the test item not exceed 10% of the chamber volume.

1.2 Noise is normally generated with an air modulator and is injected into the chamber via a coupling horn. Provision is made in the chamber design to exhaust the air from the modulator through an acoustic attenuator in order to prevent the direct transmission of high intensity noise to areas outside the test chamber.

2. PROGRESSIVE WAVE TUBES.

A parallel sided duct usually forms the working section of such a progressive noise facility. This may be circular or rectangular in section to suit the test requirements. For testing panels, a rectangular section may be more suitable while an aircraft carried store may be more conveniently tested in a duct of circular section. Noise is generated by an air modulator coupled into one end of the working section by a suitable horn. From the opposite end of the plain duct another horn couples the noise into an absorbing termination. Maximum absorption over the operating frequency range is required here in order to minimize standing wave effects in the duct. Noise then progresses along the duct and is applied with grazing incidence over the surface of the test item. The test item itself may be mounted within the duct in which case the grazing incidence wave will be applied over the whole of its external surface. Alternatively, the test item may be mounted in the wall of the duct when the noise will be applied to only that surface within the duct, e.g., on one side of a panel. The method used will depend upon the test item and its in-service application.

3. ACOUSTIC NOISE CHARACTERISTICS.

Radiated high intensity noise is subjected to distortion due to adiabatic heating. Thus, due to heating of the high pressure peaks and cooling of the rarefaction troughs, the local speed of propagation of these pressures are modified. This causes the peaks to travel faster and the troughs to travel slower than the local speed of propagation such that, at a distance from the source, a sinusoidal wave becomes triangular with a leading shock front. This waveform is rich in harmonics and therefore the energy content is extended into a higher frequency range. It can be seen from this that it is not possible to produce a pure sinusoidal tone at high noise intensities. The same effect takes place with high intensity random noise that is commonly produced by modulating an airflow with a valve driven by a dynamic actuator. Due to velocity and/or acceleration restraints on the actuator, it is not possible to modulate the airflow at

MIL-STD-810F
1 January 2000
ANNEX B

frequencies greater than about 1 kHz. Acoustic energy above this frequency, extending to 20 kHz or more, therefore results from a combination of cold air jet noise and harmonic distortion from this lower frequency modulation.

4. CONTROL STRATEGIES.

Microphones are normally used to monitor and control the test condition. When testing stores and missiles, it is recommended that not less than three microphones be used to control the test. Some test items may be more effectively monitored on their vibration response; in which case, follow the monitoring requirements of method 514.5, as appropriate. Use a monitoring system capable of measuring random noise with a peak to rms ratio of up to 3.0. Correct pressure calibrated microphones used in reverberation chambers for random incidence noise, while correcting those used in progressive wave tubes for free field grazing incidence noise, and ensure both have a linear pressure response. Provide for averaging the outputs of the microphones to provide the spatial average of the noise for control purposes.

5. DEFINITIONS.

5.1 Sound Pressure Level.

The sound pressure level (L_p) is the logarithmic ratio of the sound pressures

$$L_p = 10 \log \frac{1}{l_0} = 20 \log \frac{P}{P_0}$$

expressed as:

where l_0 = reference intensity = 10^{-12} Wm^{-2}
and P_0 = reference pressure = $20 \times 10^{-6} \text{ Pa}$

5.2 Third Octave Filters.

The center frequency, f_0 , of a third octave filter is:

$$f_0 = (f_1 \times f_2)^{1/2}$$

where f_1 = lower -3dB frequency
and f_2 = upper -3dB frequency

The relationships between the upper and lower -3dB frequencies are:

$$\frac{(f_2 - f_1)}{f_0} = 0.23$$

$$f_2 = 2^{1/3} f_1$$

Standard third octave bands are defined in International Specification ISO 266. For other definitions relevant to random vibration and data analysis, refer to method 514.5 or to NATO STANAG 4370, AECTP 400, method 401.

METHOD 516.5**SHOCK****CONTENTS**

| <u>Paragraph</u> | <u>Page</u> |
|---|-------------|
| 1. SCOPE..... | 1 |
| 1.1 Purpose..... | 1 |
| 1.2 Application..... | 1 |
| 1.3 Limitations..... | 2 |
| 2. TAILORING GUIDANCE..... | 2 |
| 2.1 Selecting the Shock Method..... | 2 |
| 2.1.1 Effects of shock..... | 2 |
| 2.1.2 Sequence among other methods..... | 3 |
| 2.2 Selecting a Procedure..... | 3 |
| 2.2.1 Procedure selection considerations..... | 3 |
| 2.2.2 Difference among procedures..... | 4 |
| 2.2.3 Test Interruption..... | 5 |
| 2.3 Determine Test Levels and Conditions..... | 5 |
| 2.3.1 General considerations – Terminology and illustration for complex transient..... | 5 |
| 2.3.2 Test conditions..... | 11 |
| 2.3.3 Test axes and number of shock events – general considerations..... | 15 |
| 2.3.4 Test axes and number of shock events – special consideration for complex transients only..... | 15 |
| 2.4 Test Item Configuration..... | 16 |
| 3. INFORMATION REQUIRED..... | 16 |
| 3.1 Pretest..... | 16 |
| 3.2 During Test..... | 17 |
| 3.3 Post-test..... | 17 |
| 4. TEST PROCESS..... | 17 |
| 4.1 Test Facility..... | 17 |
| 4.2 Controls..... | 18 |
| 4.2.1 Calibration..... | 18 |
| 4.2.2 Tolerance..... | 18 |
| 4.2.2.1 Classical pulses and complex transient pulses-time domain..... | 18 |
| 4.2.2.2 Complex transient pulses-SRS..... | 18 |
| 4.3 Instrumentation..... | 19 |
| 4.4 Data Analysis..... | 19 |
| 4.5 Test Execution..... | 20 |
| 4.5.1 Preparation for test..... | 20 |
| 4.5.1.1 Preliminary guidelines..... | 20 |
| 4.5.1.2 Pretest checkout..... | 20 |
| 4.5.1.3 Procedures overview..... | 20 |
| 4.5.2 Procedure I - Functional Shock..... | 20 |
| 4.5.2.1 Controls..... | 21 |
| 4.5.2.2 Test tolerances..... | 21 |
| 4.5.2.3 Procedure I..... | 21 |

MIL-STD-810F
1 January 2000

CONTENTS

| <u>Paragraph</u> | <u>Page</u> |
|--|-------------|
| 4.5.2.4 Analysis of results..... | 22 |
| 4.5.3 Procedure II - Materiel to be Packaged..... | 22 |
| 4.5.3.1 Controls..... | 22 |
| 4.5.3.2 Test tolerances..... | 23 |
| 4.5.3.3 Procedure II..... | 23 |
| 4.5.3.4 Analysis of results..... | 24 |
| 4.5.4 Procedure III - Fragility..... | 24 |
| 4.5.4.1 Controls..... | 24 |
| 4.5.4.2 Test tolerances..... | 25 |
| 4.5.4.3 Procedure III..... | 25 |
| 4.5.4.4 Analysis of results..... | 27 |
| 4.5.5 Procedure IV - Transit Drop..... | 27 |
| 4.5.5.1 Controls..... | 27 |
| 4.5.5.2 Test tolerances..... | 27 |
| 4.5.5.3 Procedure IV..... | 27 |
| 4.5.5.4 Analysis of results..... | 28 |
| 4.5.6 Procedure V - Crash Hazard..... | 28 |
| 4.5.6.1 Controls..... | 28 |
| 4.5.6.2 Test tolerances..... | 30 |
| 4.5.6.3 Procedure V..... | 30 |
| 4.5.6.4 Analysis of results..... | 30 |
| 4.5.7 Procedure VI - Bench handling..... | 30 |
| 4.5.7.1 Controls..... | 30 |
| 4.5.7.2 Test tolerances..... | 30 |
| 4.5.7.3 Procedure VI..... | 30 |
| 4.5.7.4 Analysis of results..... | 31 |
| 4.5.8 Procedure VII - Rail impact..... | 31 |
| 4.5.8.1 Controls..... | 31 |
| 4.5.8.2 Test tolerances..... | 32 |
| 4.5.8.3 Procedure VII..... | 32 |
| 4.5.8.4 Analysis of results..... | 34 |
| 4.5.9 Procedure VIII - Catapult Launch/Arrested Landing..... | 35 |
| 4.5.9.1 Controls..... | 35 |
| 4.5.9.2 Test tolerances..... | 37 |
| 4.5.9.3 Procedure VIII..... | 37 |
| 4.5.9.4 Analysis of results..... | 38 |
| 5. REFERENCE/RELATED DOCUMENTS..... | 38 |

FIGURES

| | |
|---|----|
| FIGURE 516.5-1. Sample shock response acceleration time history..... | 6 |
| FIGURE 516.5-2. Truncated sample shock response acceleration time history effective durations T_E and T_e | 7 |
| FIGURE 516.5-3. Truncated sample shock acceleration time history short time average RMS (averaging time approximately 13% of T_e)..... | 7 |
| FIGURE 516.5-4. Sample shock response acceleration maximax SRS..... | 9 |
| FIGURE 516.5-5. Sample shock response acceleration pseudo-velocity SRS..... | 9 |
| FIGURE 516.5-6. Sample shock response acceleration ESD estimate..... | 10 |
| FIGURE 516.5-7. Sample shock response acceleration FS estimate..... | 10 |

CONTENTS

| <u>Paragraph</u> | <u>Page</u> |
|---|-------------|
| FIGURE 516.5-8. Test SRS for use if measured data are not available (for Procedure I - Functional Shock & Procedure V - Crash Hazard)..... | 13 |
| FIGURE 516.5-9. Random test input ASD yielding equivalent test SRS spectrum shown on figure 516.5-8 (for Procedure I - Functional Shock). | 14 |
| FIGURE 516.5-10. Terminal peak sawtooth shock pulse configuration and its tolerance limits (for use when shock response spectrum analysis capability is not available in Procedure I – Functional Shock and Procedure V Crash Hazard). | 14 |
| FIGURE 516.5-11. Trapezoidal shock pulse configuration and its tolerance limits (for use when shock response spectrum analysis capability is not available in Procedure II – Materiel to be Packaged, and Procedure III - Fragility). | 16 |
| FIGURE 516.5-12. Sample measured store three axis catapult launch component response acceleration time histories..... | 36 |
| FIGURE 516.5-13. Sample measured store three axis arrested landing component response acceleration time histories..... | 37 |

TABLES

| | |
|---|----|
| TABLE 516.5-I. Test shock response spectra for use if measured data are not available..... | 13 |
| TABLE 516.5-II. Terminal peak sawtooth pulse test parameters (refer to figure 516.5-10). | 21 |
| TABLE 516.5-III. Trapezoidal pulse parameters (refer to figure 516.5-11)..... | 23 |
| TABLE 516.5-IV. Suggested drop height for Procedure II..... | 23 |
| TABLE 516.5-V. Trapezoidal pulse test parameters (refer to figure 516.5-11). | 25 |
| TABLE 516.5-VI. Transit drop test..... | 29 |
| TABLE 516.5-VII. Terminal peak sawtooth pulse test parameters (refer to figure 516.5-10)..... | 29 |
| TABLE 516.5-VIII. Impact test time speed (miles per hour - based on 22'0" rail). | 34 |

**ANNEX A. STATISTICAL CONSIDERATIONS FOR
DEVELOPING LIMITS ON PREDICTED AND PROCESSED DATA**

| | |
|---|----------|
| 1. SCOPE..... | 1 |
| 1.1 Purpose..... | 1 |
| 1.2 Application..... | 1 |
| 2. DEVELOPMENT..... | 1 |
| 2.1 Basic Estimate Assumptions..... | 1 |
| 2.2 Basic Estimate Summary Preprocessing..... | 1 |
| 2.3 Parametric Upper Limit Statistical Estimate Assumptions..... | 2 |
| 2.3.1 NTL - Upper normal one-sided tolerance limit. | 2 |
| 2.3.2 NPL - Upper normal prediction limit. | 3 |
| 2.4 Nonparametric Upper Limit Statistical Estimate Assumptions..... | 3 |
| 2.4.1 ENV – Upper limit..... | 3 |
| 2.4.2 DFL – Upper distribution-free tolerance limit. | 4 |
| 2.4.3 ETL – Upper empirical tolerance limit. | 4 |
| 3. EXAMPLE..... | 5 |
| 3.1 Input Test Data Set. | 5 |
| 3.2 Parametric Upper Limits. | 5 |
| 3.3 Nonparametric Upper Limits. | 5 |
| 3.4 Observations..... | 6 |
| 3.5 MATLAB m-function “ul.”..... | 6 |

CONTENTS

| <u>Paragraph</u> | | <u>Page</u> |
|------------------|---|-------------|
| 4. | RECOMMENDED PROCEDURES..... | 8 |
| 4.1 | Recommended Statistical Procedures for Upper Limit Estimates..... | 8 |
| 4.2 | Uncertainty Factors..... | 8 |

FIGURES

| | | |
|------------------|---|---|
| FIGURE 516.5A-1. | Input test data set..... | 5 |
| FIGURE 516.5A-2. | Parametric and non-parametric upper limits..... | 6 |
| FIGURE 516.5A-3. | MATLAB m-function "ul" for upper limit determination..... | 7 |

TABLES

| | | |
|------------------|---|---|
| TABLE 516.5A-I. | Normal tolerance factors for upper tolerance limit..... | 3 |
| TABLE 516.5A-II. | Input test data set..... | 8 |

ANNEX B. EFFECTIVE SHOCK DURATION

| | | |
|-----------|---|----------|
| 1. | SCOPE..... | 1 |
| 1.1 | Purpose..... | 1 |
| 1.2 | Application..... | 1 |
| 2. | DEVELOPMENT..... | 1 |
| 2.1 | Assumptions on Shock Envelope Development..... | 1 |
| 2.2 | T_e versus T_E | 2 |
| 3. | RECOMMENDED PROCEDURES FOR SYNTHESIS AND ANALYSIS..... | 3 |
| 3.1 | Synthesis Recommended for T_e | 3 |
| 3.2 | Synthesis Uncertainty Factors for T_e | 3 |
| 3.3 | Analysis Relationship to T_e | 3 |

FIGURES

| | | |
|-------------------|---|---|
| FIGURE 516.5B-1a. | Typical shock time history with envelope, T_E and T_e | 2 |
| FIGURE 516.5B-1b. | Typical shock time history RMS with envelope and T_e | 2 |
| FIGURE 516.5B-2. | Scatter plot T_E versus T_e | 3 |

**ANNEX C. AUTOSPECTRAL DENSITY WITH EQUIVALENT TEST
SHOCK RESPONSE SPECTRA**

| | | |
|-----------|--|----------|
| 1. | SCOPE..... | 1 |
| 1.1 | Purpose..... | 1 |
| 1.2 | Application..... | 1 |
| 2. | DEVELOPMENT..... | 1 |
| 2.1 | Assumptions on Autospectral Density..... | 1 |
| 2.2 | Assumptions on Shock Response Spectra..... | 1 |
| 3. | RECOMMENDED PROCEDURES..... | 1 |
| 3.1 | Recommended for ASD..... | 1 |
| 3.2 | Recommended for SRS..... | 1 |

CONTENTS

| <u>Paragraph</u> | FIGURES | <u>Page</u> |
|--|----------------|-------------|
| FIGURE 516.5C-1a. Sample gaussian time history for functional test for ground materiel..... | | 2 |
| FIGURE 516.5C-1b. Sample gaussian time history for functional test for flight materiel. | | 2 |
| FIGURE 516.5C-2a. SRS comparison for functional test for ground materiel..... | | 3 |
| FIGURE 516.5C-2b. SRS comparison for functional test for flight materiel. | | 3 |

MIL-STD-810F
1 January 2000

THIS PAGE INTENTIONALLY BLANK

METHOD 516.5

SHOCK

NOTE: Tailoring is essential. Select methods, procedures, and parameter levels based on the tailoring process described in Part One, paragraph 4, and Appendix C. Apply the general guidelines for laboratory test methods described in Part One, paragraph 5 of this standard.

1. SCOPE.

1.1 Purpose.

Shock tests are performed to:

- a. provide a degree of confidence that materiel can physically and functionally withstand the relatively infrequent, non-repetitive shocks encountered in handling, transportation, and service environments. This may include an assessment of the overall materiel system integrity for safety purposes in any one or all of the handling, transportation, and service environments;
- b. determine the materiel's fragility level, in order that packaging may be designed to protect the materiel's physical and functional integrity; and
- c. test the strength of devices that attach materiel to platforms that can crash.

1.2 Application.

Use this method to evaluate the physical and functional performance of materiel likely to be exposed to mechanically induced shocks in its lifetime. Such mechanical shock environments are generally limited to a frequency range not to exceed 10,000 Hz and a time duration of not more than 1.0 second. (In most cases of mechanical shock the significant materiel response frequencies will not exceed 2,000 Hz and the duration of materiel response will not exceed 0.1 second.) The materiel response to the mechanical shock environment will, in general, be highly oscillatory, of short duration, and have a substantial initial rise time with large positive and negative peak amplitudes of about the same order of magnitude.¹ The peak responses of materiel to mechanical shock will, in general, be enveloped by a decreasing form of exponential function in time. In general, mechanical shock applied to a complex multi-modal materiel system will cause the materiel to respond to (1) forced frequencies imposed on the materiel from the external excitation environment, and (2) the materiel's resonant natural frequencies either during or after application of the excitation. Such response may cause:

- a. materiel failure as a result of increased or decreased friction between parts, or general interference between parts;
- b. changes in materiel dielectric strength, loss of insulation resistance, variations in magnetic and electrostatic field strength;
- c. materiel electronic circuit card malfunction, electronic circuit card damage, and electronic connector failure. (On occasion, circuit card contaminants having the potential to cause short circuit may be dislodged under materiel response to shock.);
- d. permanent mechanical deformation of the materiel as a result of overstress of materiel structural and non-structural members;
- e. collapse of mechanical elements of the materiel as a result of the ultimate strength of the component being exceeded;

¹ For high impact velocity shock, e.g., penetration shocks, there may be significantly less or no oscillatory behavior with substantial area under the acceleration response curve.

MIL-STD-810F
1 January 2000

- f. accelerated fatiguing of materials (low cycle fatigue);
- g. potential piezoelectric activity of materials, and
- h. materiel failure as a result of cracks in fracturing crystals, ceramics, epoxies, or glass envelopes.

1.3 Limitations.

- a. This method does not include the effects of shock experienced by materiel as a result of pyrotechnic device initiation. For this type of shock see method 517, Pyroshock.
- b. This method does not include the effects experienced by materiel to very high level localized impact shocks, e.g., ballistic impacts. For this type of shock, devise specialized tests based on experimental data, and consult method 522, Ballistic Shock.
- c. This method does not include the high impact shock effects experienced by materiel aboard a ship. Consider performing shock tests for shipboard materiel in accordance with MIL-S-901 (reference k).
- d. This method does not include the effects experienced by fuse systems. Perform shock tests for safety and operation of fuses and fuse components in accordance with MIL-STD-331 (reference l).
- e. This method does not include the effects experienced by materiel that is subject to high pressure wave impact, e.g., pressure impact on a materiel surface as a result of firing of a gun. For this type of shock and subsequent materiel response, devise specialized tests based on experimental data and consult method 519.5, Gunfire Vibration.
- f. This method does not include the shock effects experienced by very large extended materiel, e.g., building pipe distribution systems, over which varied parts of the materiel may experience different and unrelated shock events. For this type of shock, specialized tests based on experimental data must be devised.
- g. This method does not include special provisions for performing shock tests at high or low temperatures. Perform tests at room ambient temperature unless otherwise specified. Guidelines found in this section of the standard, however, may be helpful in setting up and performing shock tests at high or low temperatures.
- h. This method does not include engineering guidelines related to unplanned test interruption as a result of test equipment or other malfunction. Generally, if an interruption occurs during a shock pulse input, repeat that shock pulse input. Care must be taken to ensure stresses induced by the interrupted pulse do not invalidate subsequent test results. It is incumbent on all test facilities that data from such interruptions be recorded and analyzed before continuing with the test sequence. In addition, the overall integrity of the materiel must be inspected to ensure pre-shock test materiel integrity.

2. TAILORING GUIDANCE.

2.1 Selecting the Shock Method.

After examining requirements documents and applying the tailoring process in Part One of this standard to determine where mechanical shock environments are foreseen in the life cycle of the materiel, use the following to confirm the need for this method and to place it in sequence with other methods.

2.1.1 Effects of shock.

Mechanical shock has the potential for producing adverse effects on the physical and functional integrity of all materiel. In general, the level of adverse effects increases with both the magnitude and the duration of the shock environment. Durations of shock that correspond with natural frequency periods of the materiel and/or periods of major frequency components in input shock environment waveforms that correspond with natural frequency periods of the materiel will magnify the adverse effects on the materiel's overall physical and functional integrity.

2.1.2 Sequence among other methods.

- a. General. See Part One, paragraph 5.5.
- b. Unique to this method. Sequencing among other methods will depend upon the type of testing i.e., developmental, qualification, endurance, etc and the general availability of test items for test. Normally, schedule shock tests early in the test sequence, but after any vibration tests.
 - (1) If the shock environment is deemed particularly severe, and the chances of materiel survival without major structural or functional failure are small, the shock test should be first in the test sequence. This provides the opportunity to redesign the materiel to meet the shock requirement before testing to the more benign environments with potential cost savings.
 - (2) If the shock environment is deemed severe but the chances of the materiel survival without structural or functional failure is good, perform the shock test after vibration and thermal tests, allowing the stressing of the test item prior to shock testing to uncover combined vibration, temperature, and shock environmental failures.
 - (3) In cases in which the shock test levels are deemed less severe than the vibration test levels, the shock tests may be deleted from the testing sequence.
 - (4) There are often advantages to applying shock tests before climatic tests, provided this sequence represents realistic service conditions. Test experience has shown that climate-sensitive defects often show up more clearly after the application of shock environments. However, internal or external thermal stresses may permanently weaken materiel resistance to vibration and shock that may go undetected if shock tests are applied before climatic tests.

2.2 Selecting a Procedure.

This method includes eight test procedures.

- a. Procedure I - Functional Shock.
- b. Procedure II - Materiel to be packaged.
- c. Procedure III - Fragility.
- d. Procedure IV - Transit Drop.
- e. Procedure V - Crash Hazard.
- f. Procedure VI - Bench Handling.
- g. Procedure VII - Rail Impact.
- h. Procedure VIII - Catapult Launch/Arrested Landing.

2.2.1 Procedure selection considerations.

Based on the test data requirements, determine which test procedure, combination of procedures, or sequence of procedures is applicable. In many cases, one or more of the procedures will apply. Consider all shock environments anticipated for the materiel during its life cycle, both in its logistic and operational modes. When selecting procedures, consider:

- a. The operational purpose of the materiel. From requirement documents, determine the operations or functions to be performed by the materiel before, during and after the shock environment.
- b. The natural exposure circumstances. Procedures I through VII specify single shocks which result from momentum exchange between materiel or materiel support structures and another body. Procedure VIII (catapult launch) contains a sequence of two shocks separated by a comparatively short duration vibration, i.e., transient vibration. Procedure VIII (Catapult Launch/Arrested Landing) may be considered a single shock followed by a transient vibration.

MIL-STD-810F
1 January 2000

- c. Data required. The test data required to document the test environment and to verify the performance of the materiel before, during, and after test.
- d. Procedure sequence. Refer to paragraph 2.1.2.

2.2.2 Difference among procedures.

- a. Procedure I - Functional Shock. Procedure I is intended to test materiel (including mechanical, electrical, hydraulic, and electronic) in its functional mode and to assess the physical integrity, continuity and functionality of the materiel to shock. In general, the materiel is required to function during the shock and to survive without damage to shocks representative of those that may be encountered during operational service.
- b. Procedure II - Materiel to be packaged. Procedure II is to be used when materiel will require a shipping container. It specifies a minimum critical shock resistance level to a handling drop height. The shock definition may be furnished to a package designer as a design criterion. This procedure is not intended for the test of extremely fragile materiel, e.g., missile guidance systems, precision-aligned test equipment, gyros, inertial guidance platforms, etc. For extremely fragile materiel where quantification of shock resistance is required Procedure III should be considered. See paragraph 2.3 below for processing techniques useful in expressing shock resistance criteria.
- c. Procedure III - Fragility. Procedure III is used to determine a materiel's ruggedness or fragility so that packaging can be designed for the materiel, or so the materiel can be redesigned to meet transportation and/or handling requirements. This procedure is used to determine the critical shock conditions at which there is reasonable chance of structural and/or functional system degradation. To achieve the most realistic criteria, perform the procedure at environmental temperature extremes. See paragraph 2.3 below for processing techniques useful in expressing shock fragility criteria.
- d. Procedure IV - Transit Drop. Procedure IV is intended for materiel either outside of or within its transit or combination case, or as prepared for field use (carried to a combat situation by man, truck, rail, etc.). This procedure is used to determine if the materiel is capable of withstanding the shocks normally induced by loading and unloading when it is (1) outside of its transit or combination case, e.g., during routine maintenance, when being removed from a rack, being placed in its transit case, etc., or (2) inside its transit or combination case. Such shocks are accidental, but may impair the functioning of the materiel. This procedure is not intended for shocks encountered in a normal logistic environment as experienced by materiel inside shipping containers and defined in the materiel's life cycle profile (see Procedure II – Materiel to be Packaged).
- e. Procedure V - Crash Hazard. Procedure V is for materiel mounted in air or ground vehicles that could break loose from its mounts, tiedowns or containment configuration during a crash and present a hazard to vehicle occupants and bystanders. This procedure is intended to verify the structural integrity of materiel mounts, tiedowns or containment configuration during simulated crash conditions. The test should be used to verify the overall structural integrity of the materiel, i.e., parts of the materiel are not ejected under the shock. This procedure is not intended for materiel transported as cargo for which method 513.5, Acceleration, or method 514.5, Vibration, could be applied.
- f. Procedure VI - Bench Handling. Procedure VI is intended for materiel that may typically experience bench handling, bench maintenance, or packaging. It is used to determine the ability of the materiel to withstand representative levels of shock encountered during typical bench handling, bench maintenance, or packaging. Such shocks might occur during materiel repair. This procedure may include testing for materiel with protrusions that may be easily damaged without regard to gross shock on the total materiel. The nature of such testing is highly specialized and must be performed on a case-by-case basis, noting the configuration of the materiel protrusions and the case scenarios for damage during such activities as bench handling, maintenance, and packaging. This procedure is appropriate for medium-to-large test materiel out of its transit or combination case that has a maximum dimension greater than approximately 23 cm (9 inches). Small materiel systems, in general, will be tested to higher levels during Procedure IV, Transit Drop.

- g. Procedure VII - Rail Impact. Procedure VII is intended to test materiel that will be transported by rail; to determine the effect of normal railroad car impacts that occur during rail shipment, to verify the structural integrity of the materiel, and to evaluate the adequacy of the tiedown system and the tiedown procedures. All items are to be tested at their maximum gross weight (fully loaded) rating unless otherwise specified in the transportability requirements for the materiel. This procedure is not intended for the separate testing of small, individually packaged pieces of materiel that would normally be shipped (and tested) when mounted on a pallet, or as part of a larger materiel. For such tests, the references provide guidance on environments measured during rail impact that may be useful in specially tailored laboratory testing.
- h. Procedure VIII - Catapult Launch/Arrested Landing. Procedure VIII is intended for materiel mounted in or on fixed-wing aircraft that are subject to catapult launches and arrested landings. For catapult launch, materiel may experience a combination of initial shock followed by a low level transient vibration of some duration having frequency components in the neighborhood of the mounting platform's lowest frequencies, and concluded by a final shock according to the catapult event sequence. For arrested landing, materiel may experience an initial shock followed by a low level transient vibration of some duration having frequency components in the neighborhood of the mounting platform's lowest frequencies.

2.2.3 Test interruption.

- a. General. See Part One, paragraph 5.11 of this standard.
- b. Specific to this method. Interruption of a shock test is unlikely to generate any adverse effects. Normally, continue the test from the point of interruption.

2.3 Determine Test Levels and Conditions.

Having selected this method and relevant procedures (based on the materiel's requirements documents and the tailoring process), complete the tailoring process by identifying appropriate parameter levels, applicable test conditions, and test techniques for the selected procedures. Base these selections on the requirements documents, the Life Cycle Environmental Profile, Operational Environment Documentation (see Part One, figure 1-1), and information provided with this procedure. Consider the following when selecting test levels:

2.3.1 General considerations – Terminology and illustration for complex transient.

- a. Shock. Shock is the term applied to a comparatively short time moderately high level force impulse input to materiel. For this method materiel response acceleration will generally be the experimental variable of measurement. However, this does not preclude other variables of materiel response measurement such as velocity, displacement, strain, force, or pressure from being used and processed in an analogous manner, as long as the interpretation of the measurement variable is clear and the measurement instrumentation configuration is validated, e.g., measurements made within the significant frequency range of the materiel response, etc. Figure 516.5-1 displays a moderately complex extended measured shock response acceleration time history that might, based upon the judgement of a trained analyst and the objectives of the test, reasonably be decomposed into several independent shocks. There are several useful measurement estimates of duration, amplitude, and frequency for describing the time-varying response behavior of the materiel. Four useful descriptive estimates are defined in detail with references in the Part One, Appendix D (Terminology), and will be discussed here briefly for characterizing the materiel response (1) Effective Transient Duration (T_E), (2) Shock Response Spectra (SRS), (3) Energy Spectral Density (ESD), and (4) Fourier Spectra (FS).

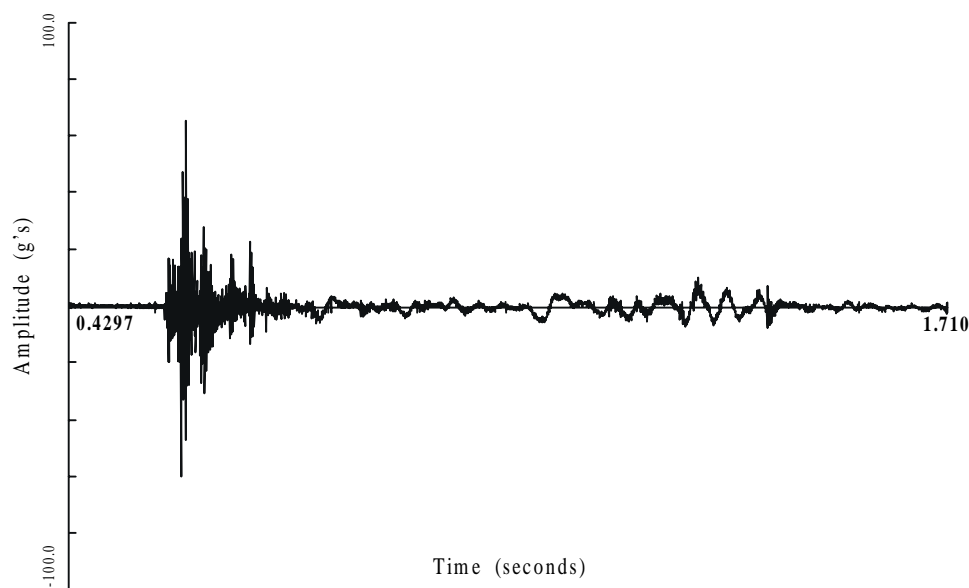

FIGURE 516.5-1. Sample shock response acceleration time history.

- (1) Effective shock duration (T_E/T_e): For Procedures I and V the effective shock duration, T_E , is defined to be the minimum length of time which contains all time history magnitudes exceeding in absolute value $1/3$ of the peak magnitude, A_p , associated with the shock event. An additional definition of effective shock duration, T_e , (potentially more useful for complex measured transients that are to be processed), will be the minimum length of time that contains at least 90% of the root-mean-square (RMS) time history amplitudes exceeding in value 10% of the peak RMS magnitude associated with the shock event. Figure 516.5-2 illustrates the effective shock durations T_E and T_e on a truncated form of the shock time history depicted on figure 516.5-1. Because of the complex and extended nature of the shock, T_E and T_e are nearly identical. For less complex shock time histories this is usually not the case (see Annex B of this method). The 90% requirement in T_e precludes extending the shock over times that include noise spikes of amplitude greater than 10% of the peak RMS magnitude. It is important to note that the RMS estimate is a function of the length of the record over which the estimate is made. For a moving average estimate the length of average should always be greater than 10% of T_e or an equivalent time constant for exponential averaging. Figure 516.5-3 provides an estimate of the short time average RMS of the time history depicted on figure 516.5-2 along with T_e (and T_E from figure 516.5-2). On figure 516.5-3 the short time averaging time is about 13% of T_e . In most cases, the judgement of an experienced analyst will be satisfactory in determining the effective duration, T_E or T_e , in place of a rigorously applied analytical definition. For determination of the effective shock duration, T_e , for any processing of measured transient time history data, it is important that (a) information inherent in the complex transient is preserved and (b) information related to instrumentation noise is minimized.

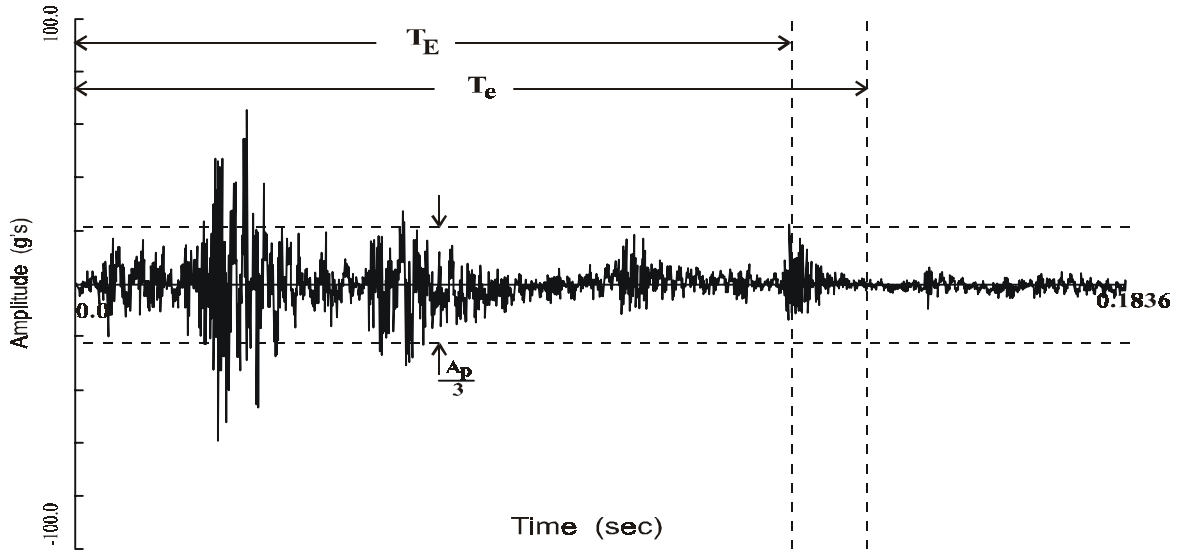

FIGURE 516.5-2. Truncated sample shock response acceleration time history effective durations T_E and T_e .

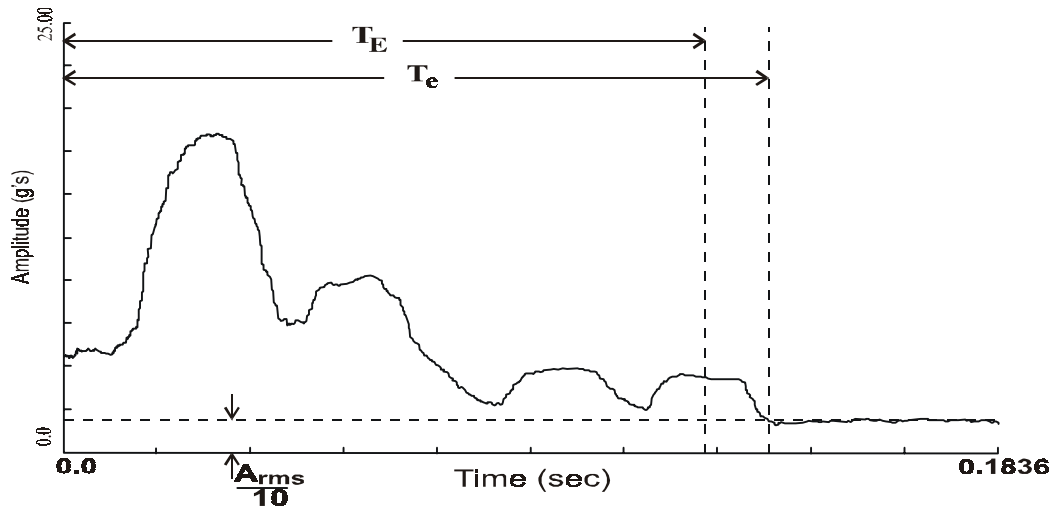

FIGURE 516.5-3. Truncated sample shock acceleration time history short time average RMS (averaging time approximately 13% of T_e).

MIL-STD-810F
1 January 2000

- (2) Shock Response Spectrum (SRS): The SRS value at a given undamped natural oscillator frequency, f_n , describes the maximum response of the mass of a damped single degree of freedom system (SDOF) at this frequency to a shock base input time history of duration T_e . Damping of the SDOF is expressed in terms of a “Q” (quality factor) value where a Q of 50 represents 1% critical damping; a Q of 10, 5% critical damping; and a Q of 5, 10% critical damping of the SDOF. For processing of shock response data, the absolute acceleration maximax SRS has become primary analysis descriptor. In this measurement description of the shock, the maximax acceleration values are plotted on the ordinate with the undamped natural frequency of the SDOF with base input plotted along the abscissa. The frequency range over which the SRS is computed extends from a lowest frequency of interest up to a frequency at which the flat portion of the spectrum has been reached. This latter upper frequency requirement helps ensure no high frequency content in the spectrum is neglected. The lowest frequency of interest is determined by the frequency response characteristics of the materiel under test. For f_{min} , the lowest frequency of interest, the SRS is computed over a time interval T_e or $1/2f_{min}$, (whichever is the greatest) starting with the first amplitude rise of the shock.
- A more complete description of the shock (potentially more useful for shock damage assessment, but not widely accepted) can be obtained by determining the maximax pseudo-velocity response spectrum and plotting this on four-coordinate paper where, in pairs of orthogonal axes, the maximax pseudo-velocity response spectrum is represented by the ordinate, with the undamped natural frequency being the abscissa and the maximax absolute acceleration along with maximax pseudo-displacement plotted in a pair of orthogonal axes, all plots having the same abscissa. The maximax pseudo-velocity at a particular SDOF undamped natural frequency is thought to be more representative of the damage potential for a shock since it correlates with stress and strain in the elements of a single degree of freedom system (reference b). If the testing is to be used for laboratory simulation, use a Q value of ten and a second Q value of 50 in the processing. Using two Q values, a damped value and a value corresponding to light damping, provides an analyst with information on the potential spread of materiel response. It is recommended that the maximax absolute acceleration SRS be the primary method of display for the shock, with the maximax pseudo-velocity SRS the secondary method of display and useful in cases in which it is desirable to be able to correlate damage of simple systems with the shock. Figure 516.5-4 displays the maximax acceleration SRS for the shock time history displayed on figure 516.5-2 over the effective shock duration, T_e , displayed on figure 516.5-3. Figure 516.5-5 displays the corresponding maximax pseudo-velocity SRS.
- (3) Energy Spectral Density (ESD): The ESD estimate, the properly scaled magnitude of the Fourier Transform of the total shock, is computed at a uniform set of frequencies and displayed as a two-dimensional plot of amplitude versus frequency. The amplitude units are “units²-sec/Hz.” In determining the ESD estimate, it is important that the Fast Fourier Transform block size is selected such that all the shock event is contained within the block; but excessive noise beyond the effective duration, T_e , of the shock be removed by zero-padding the transform block, i.e., replacing noise data values by zeros. The ESD description is useful for comparing the distribution of energy within the frequency band among several shocks. Figure 516.5-6 displays the ESD estimate for the shock time history of figure 516.5-2. For an ESD estimate, the percentage of normalized random error in the ordinate is 100%. By either (1) averaging n adjacent ESD ordinates or (2) averaging n independent, but statistically equivalent ESD estimates, the percentage of normalized random error can be decreased by $1/\sqrt{n}$.

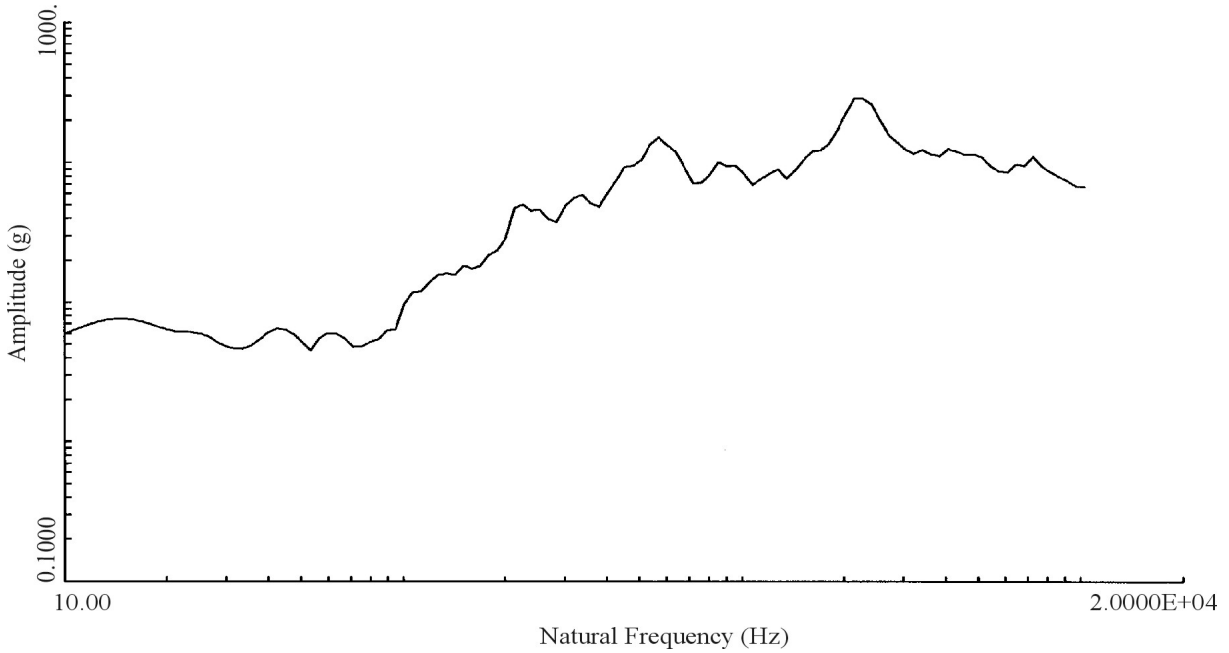

FIGURE 516.5-4. Sample shock response acceleration maximax SRS.

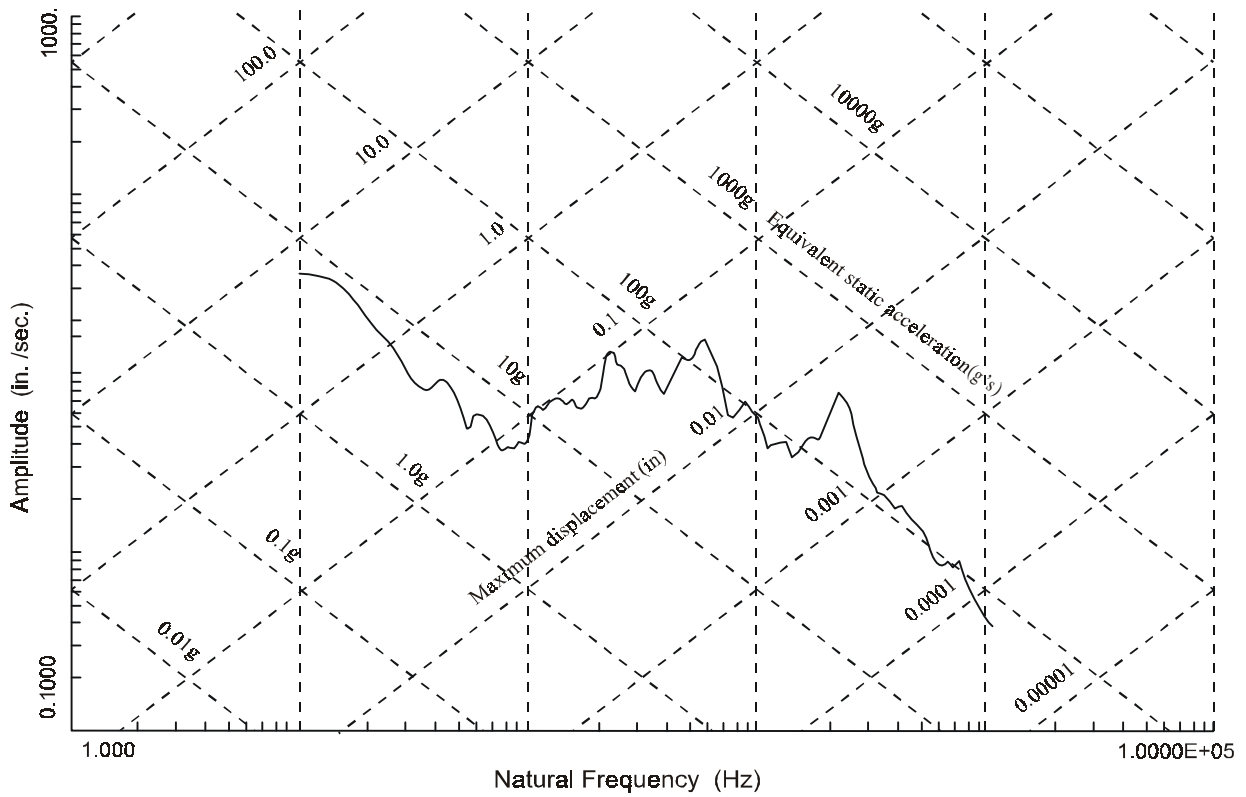

FIGURE 516.5-5. Sample shock response acceleration pseudo-velocity SRS.

MIL-STD-810F
1 January 2000

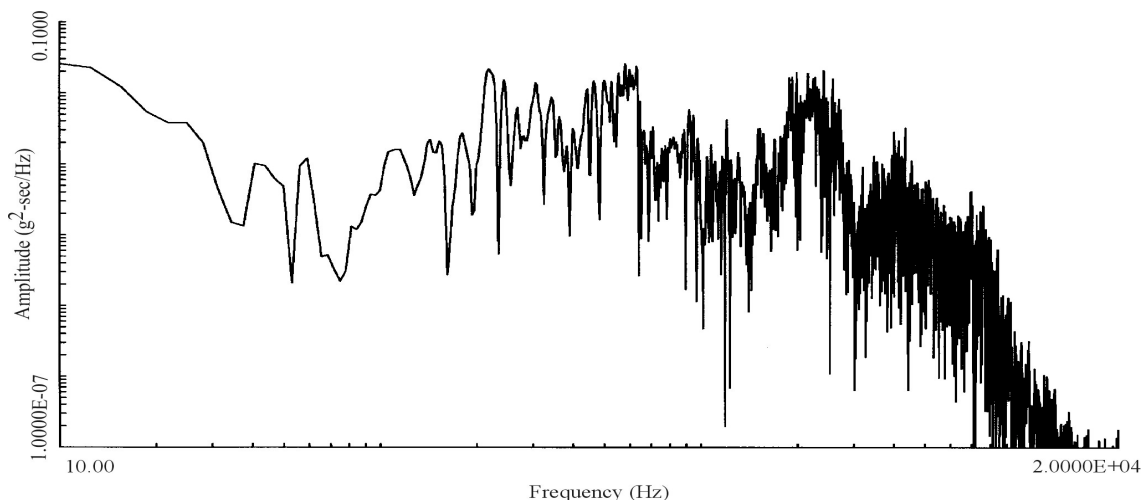

FIGURE 516.5-6. Sample shock response acceleration ESD estimate.

- (4) **Fourier Spectra (FS):** The FS estimate, the properly scaled square root of the magnitude of the Fourier Transform of the total shock, is computed at a uniform set of frequencies and displayed as a two-dimensional plot of amplitude versus frequency. The amplitude units are “units-sec.” In determining the FS estimate, it is important that the Fast Fourier Transform block size is selected such that all of the shock event is contained within the block, but excessive noise beyond the effective duration, T_e of the shock be removed by zero-padding the transform block. The FS description is useful for noting outstanding frequency components within the overall frequency band among shocks. Figure 516.5-7 displays the FS estimate for the shock time history of figure 516.5-2. For an FS estimate, the percentage of normalized random error in the ordinate is 100%. By either (1) averaging n adjacent FS ordinates or (2) averaging n independent but statistically equivalent FS estimates, the percentage of normalized random error can be decreased by $1/\sqrt{n}$.

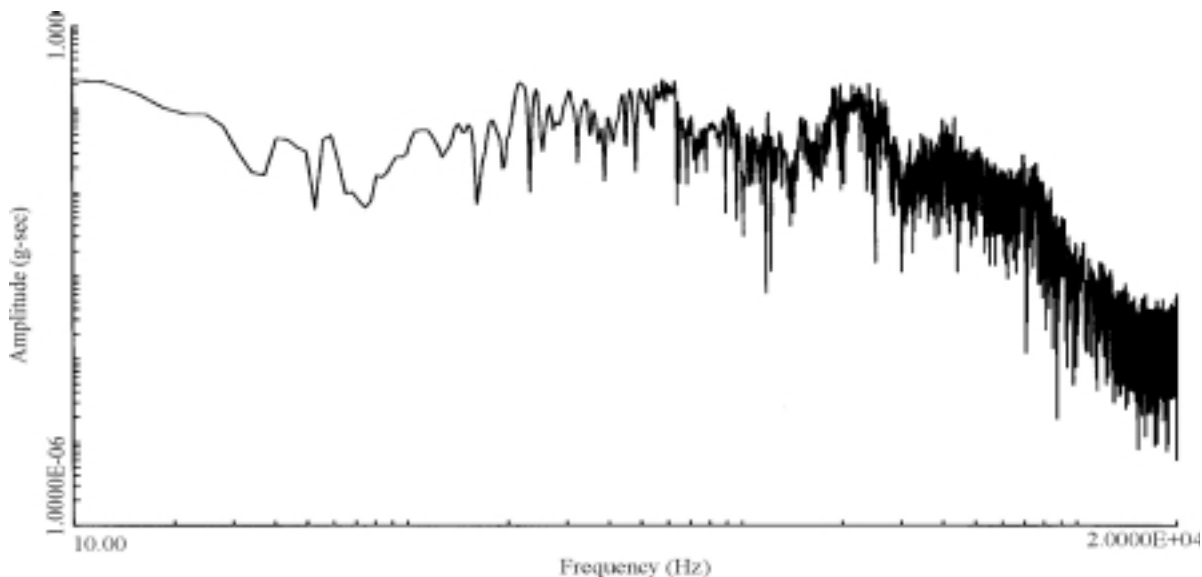

FIGURE 516.5-7. Sample shock response acceleration FS estimate.

- b. Shock/Random Vibration. In general, any one test procedure will not be required along any axis for which a sufficiently severe random vibration test procedure is required, provided that system integrity requirements are comparable. Random vibration test severity is sufficient if the shock response spectrum over a short duration of the signal based upon a three-sigma Gaussian acceleration response of a SDOF, exceeds the shock test response spectrum everywhere in the specified range of natural frequencies. The Q value to be used in the analysis is generally taken to be ten, which is equivalent to five percent of critical viscous damping. The three-sigma shock response spectrum for the random test is given, as a function of natural frequency of the SDOF, by

$$A(f) = 3 \left[\left(\frac{\pi}{2} \right) G(f) f Q \right]^{\frac{1}{2}}$$

in units of acceleration, where G(f) is the acceleration ASD at frequency f (reference a). Annex C of this method discusses the relationship between ASD levels and corresponding SRS levels for purposes of substituting a comparatively high level random vibration test for a relatively low level shock test.

- c. Statistical Estimate Processing. At times it may be convenient or even necessary to combine equivalently processed response estimates in some statistical manner. Reference g discusses some options in statistically summarizing processed results from a series of tests. The best option is dependent upon the size of sample in general. Processed results from the SRS, ESD, or FS are typically logarithmically transformed to provide estimates that are more normally distributed. This transformation is important since often very few estimates are available from a test series and the probability distribution of the untransformed estimates cannot be assumed to be normally distributed. In virtually all cases, combination of processed results will fall under the category of small sample statistics and need to be considered with care with other parametric or less powerful nonparametric methods of statistical analysis. Annex 516.5A addresses the appropriate techniques for the statistical combination of processed test results as a function of the size of the sample.
- d. Other Processing. Other descriptive processes that tend to decompose the shock into component parts, e.g., product model, time domain moments, wavelets, etc., may be useful, but are beyond the scope of this document.

2.3.2 Test conditions.

Derive the test SRS and T_e from statistical processing of (1) time history measurements of the materiel's functional environment, (2) from a carefully scaled measurement of a dynamically similar environment, (3) from prediction, or (4) from a combination of sources. For tailoring purposes, every attempt needs to be made to obtain measured data under conditions similar to service environment conditions in the Life Cycle Profile. In test SRS and T_e derivation and subsequent execution rank from the most desirable to the least desirable as follows:

- measured data summarized and shock created by way of direct reproduction of the measured data under shaker waveform control;
- measured data summarized and shock synthesized by way of a complex transient making sure that measured T_e is approximately the test T_e , and the measured waveform is similar to the synthesized waveform, i.e., amplitude and zero crossing similarity.
- no measured data but previous SRS estimates available and shock synthesized by way of a complex transient with T_e specified in some reasonable way taking into consideration the natural frequency response characteristics of the materiel;
- no measured data but classical pulse shock descriptions available for use in reproducing the shock. (The use of classical pulse description is unacceptable unless use of such pulses can be justified on the basis of analysis.)

MIL-STD-810F
1 January 2000

- a. Measured data available. T_e required for the test will be determined by examining representative time history measurements. T_e will extend from the first significant response time history point to the analytically derived T_e or to the noise floor of the instrumentation system, whichever is shortest. SRS required for the test will be determined from analytical computations. For $T_e < \frac{1}{2f_{\min}}$, T_e for test may be extended to $\frac{1}{2f_{\min}}$. The SRS analysis will be performed on the AC coupled time history for $Q = 10$ at a sequence of natural frequencies spaced at 1/12 octave or less spacing to span at least 5 to 2,000 Hz.
- (1) When a sufficient number of representative shock spectra are available, an appropriate statistical enveloping technique should be employed to determine the required test spectrum with a statistical basis (see Annex A of this method). The T_e for test should be taken as the maximum of the T_e or $\frac{1}{2f_{\min}}$, which ever is greater.
 - (2) When insufficient measured data are available for statistical analysis, an increase over the maximum of the available spectral data should be used to establish the required test spectrum. This should account for stochastic variability in the environment and uncertainty in any predictive methods employed. The degree of increase is based on engineering judgment and should be supported by rationale. In these cases, it is often convenient to envelope the SRS estimates and proceed to add either a 3dB or 6dB margin to the SRS, depending on the degree of test level conservativeness desired (see Annex A paragraph A3.2. of this method). The T_e for test should be taken as the maximum of the T_e or $\frac{1}{2f_{\min}}$, which ever is greater.
- b. Measured data not available. If a measured data base is not available, then for Procedure I - Functional shock and Procedure V - Crash hazard, employ the applicable SRS spectrum from figure 516.5-8 as the test spectrum for each axis, provided T_e of the test shock time history falls between the values in the accompanying table (516.5-I). This spectrum approximates that of the perfect terminal-peak sawtooth pulse. It is highly recommended that the test be performed with a waveform that is composed of either (1) a superposition of damped sinusoids with selected properties at a finite number of designated frequencies or (2) a superposition of amplitude modulated sine waves with selected properties at a finite number of designated frequencies, such that this waveform has an SRS that approximates the SRS on figure 516.5-8 where the duration of this waveform is a maximum of T_e provided in table 516.5-I. In reality, any complex test transient is suitable if it equals or exceeds this spectrum requirement over the frequency range of 5 to 2000 Hz, and meets the duration requirement. Use of the classical terminal-peak sawtooth pulse and the classical trapezoidal pulse is the least permissible test alternative in the case of no data being available (see paragraph 2.3.2c). In cases in which there is a vibration requirement for the materiel in addition to a shock requirement it may be possible to perform the vibration test in lieu of the shock test in the tailoring procedure. An example of this form of tailoring is contained in Procedure I - Functional Shock. Figure 516.5-9 provides two ASD curves to be used for comparison with specified ASD test environments to determine if random vibration is of sufficient severity to be used in lieu of measured or specified shock levels. The SRS for stationary random environments developed from these ASD curves, envelopes the appropriate SRS spectra on figure 516.5-8. For some empirical justification of this, see Annex C of this method.
- c. Classical shock pulses. Unless the procedure requires the use of a classical shock pulse, the use of such a pulse is not acceptable unless it can be demonstrated that measured data is within the tolerances of the classical shock pulses. Only two classical shock pulses are defined for testing in the method – the terminal peak sawtooth pulse and the trapezoidal pulse. The terminal peak sawtooth pulse along with its parameters and tolerances is provided on figure 516.5-10 and is an alternative for testing in Procedure I - Functional shock and Procedure V - Crash hazard.

TABLE 516.5-I. Test shock response spectra for use if measured data are not available.

| Test Category | Peak Acceleration (g's) | T _e (ms) | Cross-over Frequency (Hz) |
|--|-------------------------|---------------------|---------------------------|
| Functional Test for Flight Equipment | 20 | 15-23 | 45 |
| Functional Test for Ground Equipment | 40 | 15-23 | 45 |
| Crash Hazard Test for Flight Equipment | 40 | 15-23 | 45 |
| Crash Hazard Test for Ground Equipment | 75 | 8-13 | 80 |

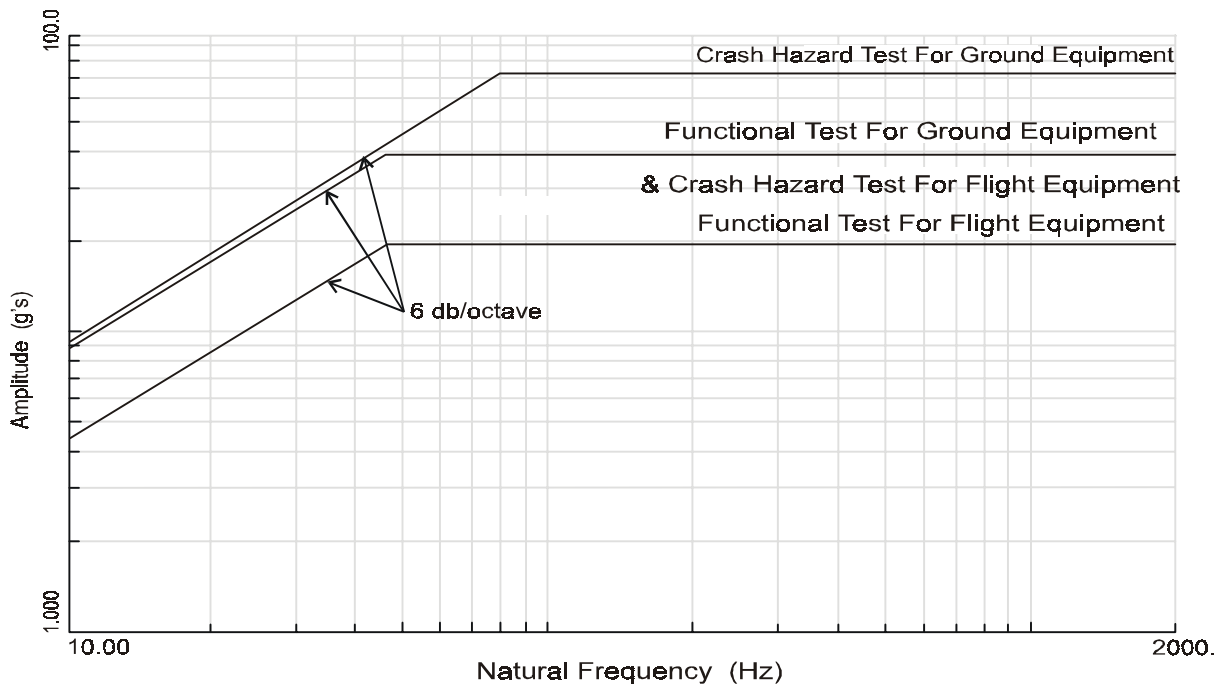
**FIGURE 516.5-8. Test SRS for use if measured data are not available (for Procedure I - Functional Shock & Procedure V - Crash Hazard).**

MIL-STD-810F
1 January 2000

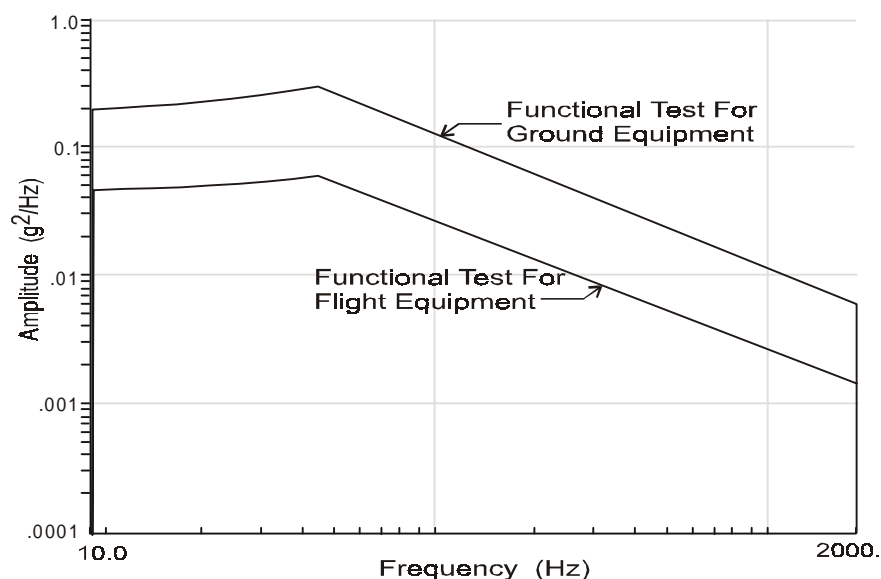
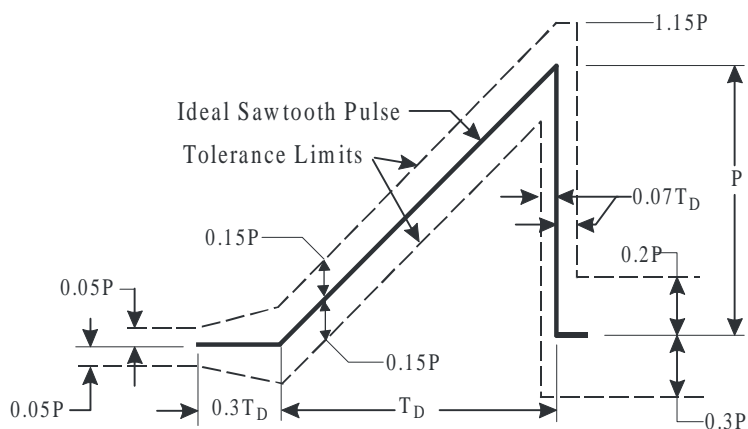

FIGURE 516.5-9. Random test input ASD yielding equivalent test SRS spectrum shown on figure 516.5-8 (for Procedure I - Functional Shock).



NOTE: Include in the time history display a time about $3T_D$ long with a pulse located approximately in the center. The peak acceleration magnitude of the sawtooth pulse is P and its duration is T_D . Ensure the measured acceleration pulse is contained between the broken line boundaries and the measured velocity change (which may be obtained by integration of the acceleration pulse) is within the limits of $V_i \pm 0.1 V_i$, where V_i is the velocity change associated with the ideal pulse which equals $0.5 T_D P$. Extend the integration to determine velocity change from $0.4 T_D$ before the pulse, to $0.1 T_D$ after the pulse.

FIGURE 516.5-10. Terminal peak sawtooth shock pulse configuration and its tolerance limits (for use when shock response spectrum analysis capability is not available in Procedure I – Functional Shock and Procedure V Crash Hazard).

The trapezoidal pulse along with its parameters and tolerances is provided on figure 516.5-11 and is an alternative for testing in Procedure II - Materiel to be Packaged, and Procedure III - Fragility.

2.3.3 Test axes and number of shock events – general considerations.

Subject the test item to a sufficient number of suitable shocks to meet the specified test conditions at least three times in both directions along each of three orthogonal axes. A suitable test shock for each direction of each axis is defined to be one classical shock pulse or complex transient pulse that yields a response spectrum that is within the tolerances of the required test spectrum over the specified frequency range, and when the effective duration of the shock is within twenty percent of the specified T_e value. Determine the spectra for positive and negative maximum accelerations (either maximum absolute or equivalent static), generally at $Q = 10$, and at least 1/12-octave frequency intervals. If the required test spectrum can be satisfied simultaneously in both directions along an axis, three shock repetitions will satisfy the requirement for that axis. If the requirement can only be satisfied in one direction, i.e., polarity consideration for classical shock inputs, it is permissible to change the test setup and impose three additional shocks to satisfy the spectrum requirement in the other direction. Setup change possibilities are to (1) reverse the polarity of the test shock time history or (2) to reverse the test item orientation (in general, for complex transient pulses, reversal of the polarity of the test shock time history will not significantly affect the test levels). The following guidelines may also be applied for either classical shock pulses or complex transient pulses.

- a. For materiel that is likely to be exposed only rarely to a given shock event, perform one shock for each appropriate environmental condition: one shock per axis minimum or two shocks per axis if polarity charge is a consideration. For large velocity change shock conditions, perform one shock for each appropriate environmental condition.
- b. For materiel that is likely to be exposed more frequently to a given shock event and there is little available data to substantiate the number of shocks, apply three or more at each environmental condition based on the anticipated in-service use, three shocks per axis minimum or six shocks per axis if polarity charge is a consideration.
- c. If the test item has no significant low frequency modal response then it is permissible to allow the low frequency portion of the SRS to fall out of tolerance in order to satisfy the high frequency portion of the SRS provided the high frequency portion begins at least one octave below the first natural mode frequency of the test item. Keep the duration within tolerance.
- d. If the test item has significant low frequency modal response, then it is permissible to allow the duration of the complex transient pulse to fall out of tolerance in order to satisfy the low frequency portion of the SRS provided the duration of the complex transient pulse does not exceed $T_e + \frac{1}{2f_{\min}}$. If the duration of the complex transient pulse must exceed $T_e + \frac{1}{2f_{\min}}$ in order to have the low frequency portion of the SRS within tolerance, then a new shock procedure must be used.

2.3.4 Test axes and number of shock events – special consideration for complex transients only.

It is well established that there is no unique synthesized complex transient pulse satisfying a given SRS. In synthesizing a complex transient pulse from a given SRS and this complex transient pulse either (1) exceeds the capability of the shock application system (usually in displacement or velocity), or (2) the duration of the complex transient pulse is more than 20% longer than T_e , some compromise in spectrum or duration tolerance may be necessary. It is unacceptable to decompose a SRS into a low frequency component (large velocity and displacement) and a high frequency component to meet a shock requirement. Often an experienced analyst may be able to specify the input parameters to the complex transient pulse synthesis algorithm in order to satisfy the requirement for which the shock application system manufacturer "optimum" solution will not. The following guidelines may be applied.

- a. If the test item has no significant low frequency modal response, it is permissible to allow the low frequency portion of the SRS to fall out of tolerance in order to satisfy the high frequency portion of the SRS, provided the high frequency portion begins at least one octave below the first natural mode frequency of the test item. Keep the duration within tolerance.
- b. If the test item has significant low frequency modal response, it is permissible to allow the duration of the complex transient pulse to fall out of tolerance in order to satisfy the low frequency portion of the SRS,

MIL-STD-810F
1 January 2000

provided the duration of the complex transient pulse does not exceed $T_e + 1/(2f_{\min})$ where the latter term is one half the period of the lowest frequency of interest (f_{\min}) in the SRS analysis. If the duration of the complex transient pulse must exceed $T_e + 1/(2f_{\min})$ in order to have the low frequency portion of the SRS within tolerance, use a new shock procedure.

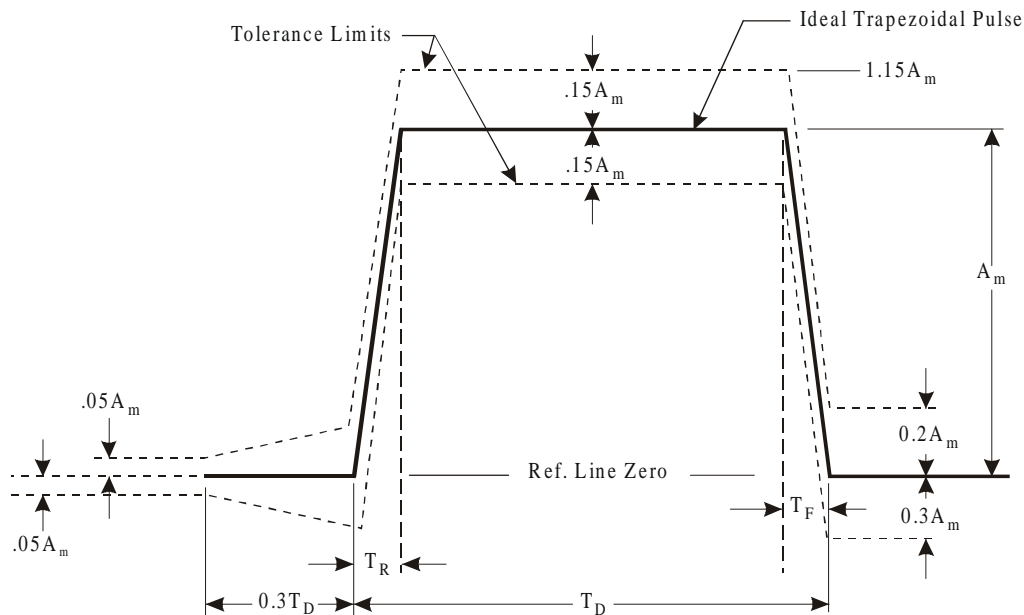

NOTE: Include in the time history display a time about $3T_D$ long with a pulse located approximately in the center. The peak acceleration magnitude of the trapezoidal pulse is A_m and its duration is T_D . Ensure the measured acceleration pulse is between the broken line boundaries and the measured velocity change (which may be obtained by integration of the acceleration pulse) is within the limits of $V_i \pm 0.1 V_b$, where V_i is the velocity change associated with the ideal pulse that approximately equals $0.5 A_m g (2T_D - T_R - T_F)$. The integration to determine velocity change extends from $0.4T_D$ before the pulse to $0.1 T_D$ after the pulse. Ensure the rise (T_R) and fall (T_F) times are less than or equal to $0.1T_D$.

FIGURE 516.5-11. Trapezoidal shock pulse configuration and its tolerance limits (for use when shock response spectrum analysis capability is not available in Procedure II – Materiel to be Packaged, and Procedure III - Fragility).

2.4 Test Item Configuration.

(See Part One, paragraph 5.8.) The configuration of the test item strongly affects test results. Use the anticipated configuration of the materiel in the life cycle profile. As a minimum, consider the following configurations:

- a. In a shipping/storage container or transit case.
- b. Deployed in the service environment.

3. INFORMATION REQUIRED.

3.1 Pretest.

The following information is required to conduct a shock test.

- a. General. Information listed in Part One, paragraphs 5.7, 5.9, and 5.11 of this standard, and Appendix A, Tasks 405 and 406.

- b. Specific to this method.
 - (1) Test fixture modal survey procedure.
 - (2) Test item/fixture modal survey procedure.
 - (3) Shock environment. Either:
 - (a) the predicted SRS or the complex shock pulse synthesis form (superposition of damped sinusoids, amplitude modulated sine waves, or other) specifying spectrum shape, peak spectrum values, spectrum break points, and pulse duration, or
 - (b) the measured data selected for use in conjunction with the SRS synthesis technique outlined in the procedures. (If the SRS synthesis technique is used, ensure both the spectral shape and synthesized shock duration are as specified.), or
 - (c) the measured data that are input as a compensated waveform into a shaker/shock system under direct waveform control.
 - (4) Techniques used in the processing of the input and the response data.

3.2 During Test.

Collect the following information during conduct of the test:

- a. General. Information listed in Part One, paragraph 5.10 and in Part One, Appendix A, Tasks 405 and 406 of this standard.
- b. Specific to this Method. Information related to failure criteria for test materiel under acceleration for the selected procedure or procedures. Pay close attention to any test item instrumentation and the manner in which the information is received from the sensors. For large velocity shock, ensure instrumentation cabling does not add noise to measurements as a result of cable movement.

3.3 Post-test.

Record the following post-test information.

- a. General. Information listed in Part One, paragraph 5.13 of this standard, and in Part One, Appendix A, Tasks 405 and 406.
- b. Specific to this method.
 - (1) Duration of each exposure and number of exposures.
 - (2) Status of the test item after each visual examination.
 - (3) Response time histories and the information processed from these time histories. In general, under-processed information, the absolute acceleration maximax SRS and the pseudo-velocity SRS should be supplied as a function of single degree of freedom oscillator undamped natural frequency. In certain cases, the ESD and FS may be supplied.
 - (4) Test item and/or fixture modal analysis data.

4. TEST PROCESS.

4.1 Test Facility.

Use a shock-producing apparatus capable of meeting the test conditions as determined according to the appropriate paragraphs of this method. The shock apparatus may be of the free fall, resilient rebound, nonresilient rebound, hydraulic, compressed gas, electrodynamic shaker, electrohydraulic shaker, rail car or other activating types capable of eliciting test item response over the time, amplitude and frequency ranges specified. For all types of shock-producing apparatus, careful attention needs to be paid to the time, amplitude, and frequency ranges over which the apparatus is capable of delivering a shock input. For example, an electrodynamic shaker can suitably reproduce

MIL-STD-810F
1 January 2000

synthesized shock records from 5 Hz to 3000 Hz; however, an electrohydraulic shaker may have only a DC to 500 Hz controllable frequency reproduction range. Procedures II and III require test apparatus capable of producing relatively large displacement. Procedure VII is a special test setup utilizing rail cars and provides both moderately high response frequencies along with very low frequency response. Procedure VIII for catapult launch is best satisfied by application of two shock pulses with an intervening “transient vibration.”

4.2 Controls.

4.2.1 Calibration.

The shock apparatus will be user calibrated for conformance with the specified test requirement from the selected procedure where the response measurements will be made with traceable laboratory calibrated measurement devices. Conformance to test specifications will, in general, use a “calibration load” in the test setup. The calibration load will, in general, be a mass/stiffness simulant of the test item. “Mass/stiffness simulants” imply that the modal dynamic characteristics of the test item are replicated to the extent possible in the simulant – particularly those modal dynamic characteristics that may interact with the modal dynamic configuration of the fixturing and/or the test device. For calibration, produce two consecutive input applications to a calibration load which satisfy the test conditions outlined in Procedures I, II, III, V, VI, or VIII. Procedure IV is not a calibrated test and Procedure VII has a unique set of prescribed calibration procedures. After processing the measured response data from the calibration load and verifying that it is in conformance with the test specification tolerances, remove the calibration load and perform the shock test on the test item. Use of calibration loads for setup is highly recommended in all cases.

4.2.2 Tolerance.

For test validation, use the tolerances specified under each individual procedure, along with the guidelines provided below. In cases in which such tolerances cannot be met, establish achievable tolerances that are agreed to by the cognizant engineering authority and the customer prior to initiation of test. In any case, where tolerances are established independently of the guidance provided below, establish those tolerances that are within the limitations of the specified measurement calibration, instrumentation, signal conditioning, and data analysis procedures.

4.2.2.1 Classical pulses and complex transient pulses-time domain.

For the classical pulses of the terminal-peak sawtooth pulse and the trapezoidal pulse tolerance limits on the time domain representation of the pulses (both for amplitude and duration) are as specified on figure 516.5-10 and figure 516.5-11, respectively. For complex transient pulses specified in the time domain the major peaks and valleys of the measured pulses, (peaks and valleys within 75% of the maximum peak and valley specified, respectively) 90% of the peak and valley levels are to be within $\pm 10\%$ of the specified peaks and valleys, respectively. This tolerance limit assumes that the shock test machine is able to replicate the specified shock accurately under a waveform control procedure. Such time domain specification is useful for shock replication from measured data and for fragility tests performed using an electrodynamic or electrohydraulic test machine. Inherent in the tolerance specification is the assumption that the measured peak and valley sequence is ordered as the specified peak and valley time history peak and valley sequence.

4.2.2.2 Complex transient pulses-SRS.

For complex transient pulses specified by way of the maximax SRS on figure 516.5-8 and for the other complex transient pulses specified from measured data generally the tolerances are specified in terms of amplitude over a specified frequency bandwidth and a tolerance on the pulse duration. If prior measured data is available or a series of shocks are performed all acceleration maximax SRS computed with a one-twelfth octave frequency resolution are to be within -1.5 dB and $+3$ dB over a minimum of 90% of the overall frequency bandwidth from 10 Hz to 2 kHz. For the remaining 10% part of the frequency band all SRS are to be within -3 dB and $+6$ dB. The duration of the complex transient is to be within $\pm 20\%$ of the effective duration of the measured pulse, T_e . In addition, the following guidance is provided for use of (1) the pseudo-velocity response spectra and (2) multiple measurements to specify a shock environment. All tolerances are specified on the maximax acceleration SRS. Any tolerances specified on the

pseudo-velocity response spectra must be derived from the tolerances on the maximax acceleration SRS and be consistent with those tolerances including tolerance on the duration of the pulse. The test tolerances are stated in terms of single measurement tolerance. For an array of measurements defined in terms of a "zone" (reference g) amplitude tolerance may be specified in terms of an average of the measurements within a "zone." It should be noted, however, this is in effect a relaxation of the single measurement tolerance and that individual measurements may be substantially out of tolerance while the average is within tolerance. In general, when specifying test tolerances based on averaging for more than two measurements within a zone, the tolerance band should not exceed the 95/50 one-sided normal tolerance upper limit computed for the logarithmically transformed SRS estimates nor be less than the mean minus 1.5dB. Any use of "zone" tolerances and averaging must have support documentation prepared by a trained analyst. Tolerance on the duration of the pulse shall apply to the input pulse duration to the measurement array.

4.3 Instrumentation.

In general, acceleration will be the quantity measured to meet the specification. On occasion other devices may be employed, e.g., linear displacement/voltage transducer, force gage, laser velocimeter, rate gyro, etc. In these cases give special consideration to the instrument specification to satisfy the calibration, measurement, and analysis requirements. Calibrate all measurement instrumentation to traceable national calibration standards (see Part One, paragraph 5.3.2). In addition, instrumentation to measure test item function may be required. In this case, obtain suitable calibration standards and adhere to them.

- a. Accelerometer.
 - (1) Transverse sensitivity of less than or equal to 5%.
 - (2) An amplitude linearity within 10% from 5% to 100% of the peak acceleration amplitude required for testing.
 - (3) For Procedures I, II, III, IV, V, VI, and VIII, a flat frequency response within $\pm 10\%$ across the frequency range 2 Hz - 2000 kHz.
 - (4) For cases in which response below 2 Hz is desired, piezoresistive accelerometer measurement is required with a flat frequency response within $\pm 10\%$ across the measurement specification bandwidth.
 - (5) The measurement device and its mounting will be compatible with the requirements and guidelines provided in reference f.
- b. Other measurement devices. Any other measurement devices used to collect data must be demonstrated to be consistent with the requirements of the test, in particular, the calibration and tolerance information provided in paragraph 4.2.
- c. Signal conditioning. Use only signal conditioning that is compatible with the instrumentation requirements on the test and is compatible with the requirements and guidelines provided in reference f. In particular, filtering of the analog voltage signals will be consistent with the time history response requirements (in general, demonstrable linearity of phase throughout the frequency domain of response) and the filtering will be so configured that anomalous acceleration data caused by clipping will not be misinterpreted as response data. In particular, use extreme care in filtering the acceleration signals at the amplifier output. The signal into the amplifier should never be filtered for fear of filtering bad measurement data and the inability to detect the bad measurement data. The signal from the signal conditioning must be anti-alias filtered before digitizing.

4.4 Data Analysis.

- a. An analog anti-alias filter configuration will be used that will:
 - (1) not alias more than a 5 percent measurement error into the frequency band of interest.
 - (2) have linear phase-shift characteristics in the data passband.

MIL-STD-810F
1 January 2000

- (3) have a pass band uniform to within one dB across the frequency band of interest (see paragraph 4.3).
- b. In subsequent processing of the data, use any additional digital filtering that is compatible with the anti-alias analog filtering. In particular, additional digital filtering must maintain phase linearity for processing of shock time histories.
- c. Analysis procedures will be in accordance with those requirements and guidelines provided in reference f. In particular, validate the shock acceleration amplitude time histories according to the procedures in reference f. Integrate each amplitude time history to detect any anomalies in the measurement system, e.g., cable breakage, amplifier slew rate exceedance, data clipped, unexplained accelerometer offset, etc., before processing the response time histories. If anomalies are detected, discard the invalid measured response time history data.

4.5 Test Execution.

4.5.1 Preparation for test.

4.5.1.1 Preliminary guidelines.

Prior to initiating any testing, review the pretest information in the test plan to determine test details (e.g., procedure, calibration load, test item configuration, measurement configuration, shock level, shock duration, number of shocks applied). Note all details of the test validation procedures.

4.5.1.2 Pretest checkout.

After calibration of the excitation input device and prior to conducting the test, perform a pretest checkout of the test item at standard ambient conditions to provide baseline data. Conduct the checkout as follows:

- Step 1. Conduct a complete visual examination of the test item with special attention to stress areas or areas identified as being particularly susceptible to damage and document the results.
- Step 2. Where applicable, install the test item in its test fixture.
- Step 3. Conduct a test item operational check in accordance with the approved test plan and document the results for compliance with Part One, paragraph 5.15.
- Step 4. If the test item operates satisfactorily, proceed to the first test. If not, resolve the problem and restart at Step 1.

4.5.1.3 Procedures overview.

Paragraphs 4.5.2 through 4.5.9 provide the basis for collecting the necessary information concerning the system under shock. For failure analysis purposes, in addition to the guidance provided in Part One, paragraph 5.14, each procedure contains information to assist in the evaluation of the test results. Analyze any failure of a test item to meet the requirements of the system specifications, and consider related information such as follows in paragraphs 4.5.2 through 4.5.9.

4.5.2 Procedure I - Functional Shock.

The intent of this test is to disclose equipment malfunction that may result from shocks experienced by materiel during use in the field. Even though materiel has successfully withstood even more severe shocks during shipping or transit shock tests, there are differences in support and attachment methods and in functional checking requirements that make this test necessary. Tailoring of the test is required when data are available, can be measured, or can be estimated from related data using accepted dynamic scaling techniques. When measured field data are not available for tailoring, use the information on figure 516.5-8 and the accompanying table 516.5-I to define the shock test system input SRS. In the calibration procedure, the calibration load will be subject to a properly compensated complex waveform in accordance with the SRS described above for electrodynamic or electrohydraulic shock testing. In general, tests using classical pulses, e.g., half-sine, terminal peak saw tooth, etc., are unacceptable unless it can be demonstrated during tailoring that the field shock environment approximates such a form. If all other testing resources have been exhausted it will be permissible to use the information on figure 516.5-10 for the

terminal peak sawtooth for testing. However, such testing must be performed in a positive and negative direction to assure meeting the spectrum requirements on figure 516.5-8 in both the positive and negative direction. In cases in which the test item has been exposed to random vibration prior to shock testing, figure 516.5-9 presents ASD requirements that provide for “equivalent test SRS.” If the prior random vibration levels meet or exceed the ASD levels provided on figure 516.5-8, the functional shock test may be waived under approval of the cognizant test authority, however, functional test requirements must be the same between the vibration and the proposed shock test.

4.5.2.1 Controls.

Figure 516.5-8 provides predicted input SRS for the functional shock test for use when measured data are not available, and when the test item configuration falls into one of two specified categories – (1) flight equipment, or (2) ground equipment. The duration, T_e , is defined in paragraph 2.3.1, and is specified in table 516.5-I. Figure 516.5-9 provides the predicted random vibration test input ASD's that yield the equivalent SRS given on figure 516.5-8. If the prior random vibration levels meet or exceed the ASD levels provided on figure 516.5-9, the functional shock test may be waived. Functional test requirements must be the same between the vibration and the shock tests.

TABLE 516.5-II. Terminal peak sawtooth pulse test parameters (refer to figure 516.5-10).

| Test | Minimum Peak Value (P) g's | | Nominal Duration (T_D) ms | |
|-----------------|--|-----------------------|--|-----------------------|
| | Flight Vehicle Equipment ¹ a | Ground Equipment b | Flight Vehicle Equipment ¹ c | Ground Equipment d |
| Functional Test | 20 | 40 ² | 11 | 11 |

¹ Shock parameters a and c: Recommend for materiel not shock-mounted and weighing less than 136 kg (300 lbs).

² For materiel mounted only in trucks and semi-trailers, use a 20g peak value.

4.5.2.2 Test tolerances.

For complex transients from measured data, ensure that test tolerances are consistent with the general guidelines provided in paragraph 4.2.2 with respect to the information provided in table 516.5-I and accompanying figure 516.5-8. For random test input ASD yielding an equivalent test SRS spectrum, the lower tolerance band on the ASD of figure 516.5-9 is to be -1dB over the entire frequency band of interest with no specification for the upper tolerance band (generally when the equivalence testing is used it is because the vibration requirement is substantially more severe than that defined by the ASD spectra on figure 516.5-9). Annex C provides additional information related to the empirical spread of the maximax SRS for $Q=5$ given the ASD inputs on figure 516.5-9.

For classical pulse testing, the test tolerances are specified on figure 516.5-10 with respect to information in table 516.5-II.

4.5.2.3 Procedure I.

Step 1. Select the test conditions and calibrate the shock test apparatus as follows:

- a. Select accelerometers and analysis techniques that meet or exceed the criteria outlined in paragraph 4.3 of reference f.
- b. Mount the calibration load to the shock test apparatus in a configuration similar to that of the test item. If the materiel is normally mounted on vibration/shock isolators, ensure the corresponding test item isolators are functional during the test. If the shock test apparatus input waveform is to be compensated via input/output impulse response function for waveform control, exercise care to details in the calibration configuration and the subsequent processing of the data.

MIL-STD-810F
1 January 2000

- c. Perform calibration shocks until two consecutive shock applications to the calibration load produce waveforms that meet or exceed the derived test conditions consistent with the test tolerances in paragraph 4.5.2.2 for at least the test direction of one axis.
 - d. Remove the calibration load and install the test item on the shock apparatus.
- Step 2. Perform a pre-shock functional check of the test item.
- Step 3. Subject the test item (in its operational mode) to the test shock input.
- Step 4. Record necessary data to show that the shock met or exceeded desired test levels within the specified tolerances in paragraph 4.5.2.2. This includes test setup photos, test logs, and photos of actual shocks from the transient recorder or storage oscilloscope. For shock and vibration isolated assemblies inherent within the test item, make measurements and/or inspections to assure these assemblies did not impact with adjacent assemblies. If required, record the data to show that the materiel functions satisfactorily during shock.
- Step 5. Perform a post test functional check on the test item. Record performance data.
- Step 6. Repeat steps 2, 3, 4, and 5 three times for each orthogonal test axis if the SRS form of specification is used. If the classical shock form of specification is used, subject the test item to both a positive and a negative input pulse. If the SRS waveform satisfies both the pulse time history tolerance, and the SRS test tolerance, proceed to test with polarity considerations (a total of six shocks in each orthogonal axis). If one or both of the test pulse's time history or SRS falls outside the pulse time history tolerance or the SRS test tolerance, continue to tailor the pulses until both test tolerances are met. If both test tolerances cannot be met simultaneously, choose to satisfy the SRS test tolerance.
- Step 7. Document the test sequence.

4.5.2.4 Analysis of results.

In addition to the guidance in Part One, paragraph 5.14, the following information is provided to assist in the evaluation of the test results. Consider any interruption of the materiel functions during or after the shock in relationship to the materiel's functional test requirements.

4.5.3 Procedure II - Materiel to be Packaged.

The intent of this test is to ensure the functionality of materiel after it has been inadvertently dropped before, during, or after a packaging process. In general, such input to the materiel produces large velocities and large changes in velocity. For this procedure, the classical trapezoidal pulse may be used on properly calibrated drop machines if the large velocity/velocity change exceeds that available on standard electrodynamic and electrohydraulic test equipment. However, if the large velocity/velocity change is compatible with the capabilities of electrodynamic and/or electrohydraulic test equipment consideration should be given to tailoring the shock according to a complex transient for application on the electrodynamic or electrohydraulic test equipment. Using the classical trapezoidal pulse on electrodynamic and/or electrohydraulic test equipment is acceptable if there is no available measured data contrary to the response time history form for this approach. In any case, when data are available or can be measured, or can be estimated from related data, tailor the test using accepted dynamic scaling techniques.

4.5.3.1 Controls.

For application of the classical trapezoidal pulse subject the unpackaged test item in a nonoperational mode to a series of trapezoidal 30-g shock pulses, i.e., $A_m = 30g$, having a time duration (in seconds) to be determined from table 516.5-III and the equation

$$T_D = \frac{2\sqrt{2\frac{h}{g}}}{A_{m/g}} = \frac{2\sqrt{2gh}}{A_m}$$

where h is the design drop height and g is the acceleration of gravity. The equation for T_D assumes a 100% elastic rebound.

TABLE 516.5-III. Trapezoidal pulse parameters (refer to figure 516.5-11).

| Test | Peak Value (A_m) g's | Nominal Duration (T_D) (sec) |
|----------------|--------------------------|----------------------------------|
| Packaged Shock | 30 | $\frac{2\sqrt{2gh}}{A_m}$ |

TABLE 516.5-IV. Suggested drop height for Procedure II.

| Package Gross Weight, kg (lb) | Type of Handling | Design Drop Height, cm (in) | Maximum Test Item Velocity Change * cm/s (in/s) |
|-------------------------------|------------------|-----------------------------|---|
| 0 to 9.1 (0 to 20) | Manual | 76 (30) | 772 (304) |
| 9.2 to 18.2 (21 to 40) | Manual | 66 (26) | 719 (283) |
| 18.3 to 27.2 (41 to 60) | Manual | 61 (24) | 691 (272) |
| 27.4 to 36.3 (61 to 80) | Manual | 46 (18) | 600 (236) |
| 36.4 to 45.4 (81 to 100) | Manual | 38 (15) | 546 (215) |
| 45.5 to 68.1 (101 to 150) | Mechanical | 31 (12) | 488 (192) |
| 68.2 to 113.5 (151 to 250) | Mechanical | 26 (10) | 447 (176) |
| 113.6 - (251 -) | Mechanical | 20 (8) | 399 (157) |

*For an assumed 100% elastic rebound.

The pulse will be in accordance with figure 516.5-11. A programmable shock machine or a long stroke electrohydraulic shaker will more than likely be required to reproduce these test conditions because of the substantial displacement and velocity requirements. The trapezoidal pulse shape was chosen because:

- (1) computation of velocity change it produces (for comparison with design drop height is much easier to make and more reproducible than most shock spectrum synthesis routines that allow for more general pulses).
- (2) trapezoidal pulse shape provides an upper bound on primary and maximax SRS for a given peak acceleration input level where the primary SRS is defined to be the SRS over the duration of the pulse only.

For a tailored test using a complex waveform with SRS shock control, ensure the test input to the item is within specified test tolerances.

4.5.3.2 Test tolerances.

For complex transients from measured data, ensure that test tolerances are consistent with the general guidelines provided in paragraph 4.2.2. For classical pulse testing, ensure the test tolerances specified in figure 516.5-11 with respect to the information provided in table 516.5-III are satisfied.

4.5.3.3 Procedure II.

Step 1. Calibrate the shock machine as follows:

- a. Mount the calibration load to the test apparatus in a configuration similar to that of the actual test item. Use a fixture similar in shape and configuration to the shock attenuation system that will support the materiel in its shipping container. The fixture should be as rigid as possible to prevent distortion of the shock pulse input to the test item. If the test apparatus input waveform is to be compensated via input/output impulse response function, exercise care to details in the calibration configuration and the subsequent processing of the data.
- b. Perform calibration shocks until two consecutive shock applications to the calibration load reproduce waveforms that are within the test tolerance specification.

Step 2. Remove the calibration load and install the actual test item on the shock apparatus.

MIL-STD-810F
1 January 2000

- Step 3. Perform a pre-shock functional test of the test item.
- Step 4. Subject the test item to the test pulse.
- Step 5. Record necessary test data to include test setup photos, test logs, and photos of the actual test pulse from a transient recorder or storage oscilloscope.
- Step 6. Perform a post shock functional test of the test item.
- Step 7. For classical trapezoidal shock waveform repeat steps 3, 4, 5, and 6 once in each direction for three orthogonal axes with positive and negative polarity (six shocks total). For a complex shock waveform repeat steps 3, 4, 5, and 6 once in each direction for three orthogonal axes (three shocks total).
- Step 8. Document the results including plots of the measured test response waveforms and any pre- or post shock functional anomalies.

4.5.3.4 Analysis of results.

In addition to the guidance in Part One, paragraph 5.14, the following information is provided to assist in the evaluation of the test results. In the evaluation consider any damage to the shock mounts or the internal structural configuration of the test item which may provide a cause for the development of a failure analysis course of action to consider retrofit or redesign.

4.5.4 Procedure III - Fragility.

The intent of this test is to determine (1) the maximum level of input to which the materiel can be exposed and still continue to function as required by its operational guide without damage to the configuration or, (2) determine the minimum level of input on which exposure to a higher level of input will most likely result in either functional failure or configuration damage. Determination of the fragility level is accomplished by starting at a benign level of shock and proceeding to increase the level of shock to the test item until:

- a. failure of the test item occurs.
- b. a predefined test objective is reached without failure of the test item.
- c. a critical level of shock is reached that indicates failure is certain to occur at a higher level of shock.

(c. implies that an analysis of the materiel has been completed prior to testing, that critical elements have been identified with their "stress thresholds", and a failure model of the materiel relative to the shock input level has been developed. In addition, during the test the "stress thresholds" of these critical elements can be monitored and input to a failure model to predict failure at a given shock input level.) In general, such input to the materiel produces large velocities and large changes in velocity. For this procedure, the classical trapezoidal pulse may be used on properly calibrated drop machines, if the large velocity/velocity change exceeds that available on standard electrodynamic and electrohydraulic test equipment. However, if the large velocity/velocity change is compatible with the capabilities of electrodynamic and/or electrohydraulic test equipment, consideration should be given to tailoring the shock according to a complex transient for application on the electrodynamic or electrohydraulic test equipment. Using trapezoidal pulse on electrodynamic and/or electrohydraulic test equipment is acceptable if there is no available data, providing shock input information that is tailorable to a complex transient. For testing, note that there is a single parameter (peak amplitude of the shock input) to define the fragility level holding the maximum velocity change of the test shock approximately constant. In the case of SRS synthesis, maximum velocity change is not as well defined, nor as important, nor as easily controllable as for the classical trapezoidal pulse. Tailoring of the test is required when data are available, can be measured, or can be estimated from related data using accepted dynamic scaling techniques. An inherent assumption in the fragility test is that damage potential increases linearly with input shock level. If this is not the case, other test procedures may need to be employed for establishing materiel fragility levels.

4.5.4.1 Controls.

- a. Select a design drop height, h , based on measurement of the materiel's shipping environment, or from table 516.5-IV when measured data are unavailable. (A design drop height is the height from which the materiel might be dropped in its shipping configuration and be expected to survive.) A maximum test

item velocity change may be taken from table 516.5-IV or determined by using the following relationship:

$$\Delta V = 2\sqrt{2gh}$$

where

ΔV = maximum product velocity change cm/s (in/s) (summation of impact velocity and rebound velocity)

h = design drop height cm (in)

g = 980.6 cm/s² (386 in/s²)

The maximum test velocity change assumes 100% rebound. Programming materials, other than pneumatic springs, may have less than 100% rebound, so the maximum test velocity needs to be decreased accordingly. If the maximum test velocity specified is used for drop table shock machine programming materials other than pneumatic springs, the test is conservative (an overtest), and the maximum test item velocity is a bounding requirement.

- b. Set the shock machine to a maximum acceleration level (A_m) well below the anticipated fragility level (see table 516.5-V). Determine the appropriate pulse duration from the design drop height, h, and the expression for T_D in paragraph 4.5.3.1. If an initial value for A_m does not exist, use 15g's. If no damage occurs, increase A_m incrementally while holding the maximum test item velocity change constant (i.e., decrease the pulse duration) until damage to the test item occurs. This will establish the materiel's critical acceleration fragility level.
- c. Test levels used in this procedure represent the correlation of the best information currently available from research and experience. If more applicable test level data become available, they should be used (reference c). In particular, if data are collected on a materiel drop and the SRS of the environment computed, a scaled version of the SRS could be used to establish the acceleration fragility level with respect to a measured environment on electrodynamic or electrohydraulic test equipment, provided the displacement and velocity limitations of the test equipment are not exceeded, and the maximum test item velocity change can be held approximately constant. In addition to the maximax acceleration response spectra, compute the pseudovelocity response spectra.

4.5.4.2 Test tolerances.

It is assumed that the instrumentation noise in the measurements is low so that tolerances may be established. For complex transients from measured data, ensure that test tolerances are consistent with the general guidelines provided in paragraph 4.2.2. For classical pulse testing, ensure the test tolerances specified on figure 516.5-11 with respect to the information provided in table 516.5-V are satisfied.

TABLE 516.5-V. Trapezoidal pulse test parameters (refer to figure 516.5-11).

| Test | Peak Value (A_m) g's | Nominal Duration (T_D) (sec) |
|-----------|--------------------------|----------------------------------|
| Fragility | 10 to 50 | $\frac{2\sqrt{2gh}}{A_m}$ |

4.5.4.3 Procedure III.

This test is designed to build up in severity until a test item failure occurs or a predetermined goal is reached. It may be necessary to switch axes between each shock event unless critical axes are determined prior to test. In general, all axes of importance will be tested at the same level before moving to another level. The order of test activity and the calibration requirements for each test setup should be clearly established in the test plan. It is also desirable to preselect the steps in severity based on knowledge of the materiel item or the test environment and document this in the test plan. It is important to note that unless critical stress thresholds are analytically predicted and instrumentation used to track stress threshold buildup, there is no rational way to estimate the potential for stress threshold exceedance at the next shock input level. The following procedures, one for a classical pulse and the other

MIL-STD-810F
1 January 2000

for a complex transient, are written as if the test will be conducted in one axis alone. In cases where more test axes are required the procedure should be modified accordingly.

- a. Classical Pulse. This part of the procedures assumes that the classical pulse approach is being used to establish the fragility level by increasing the drop height of the test item thereby increasing the ΔV directly. The fragility level is given in terms of the measurement variable – peak acceleration of the classical pulse.
- Step 1. Mount the calibration load to the test apparatus in a configuration similar to that of the actual test item. Use a fixture similar in configuration to the interface of the shock attenuation system (if any) that will support the materiel. The fixture should be as rigid as possible to prevent distortion of the shock pulse input to the test item.
- Step 2. Perform calibration shocks until two consecutive shock applications to the calibration load reproduce the waveforms that are within the specified test tolerances. If response to the calibration shock is nonlinear with respect to shock input level, then other test procedures may need to be applied to establish materiel fragility levels depending upon the extent of the nonlinearity prior to reaching the "stress threshold".
- Step 3. Select a drop height low enough to assure that no damage will occur. For drop heights other than those in table 516.5-IV the maximum velocity change can be taken to be

$$\Delta V = 2\sqrt{2gh}$$

Where

ΔV = maximum test item velocity change, cm/s (in/s) (assumes full resilient rebound of test item)

h = drop height, cm (in)

g = acceleration of gravity 981 cm/s² (386 in/s²)

- Step 4. Mount the test item in the fixture. Inspect and functionally test the item to document the pre-test condition.
- Step 5. Perform the shock test at the selected level and examine the recorded data to assure the test is within tolerance.
- Step 6. Visually examine and functionally test the materiel to determine if damage has occurred. If damage is found or pre-established goals have been reached, go to Step 10.
- Step 7. If it is required to determine the fragility of the test item in more than one axis then proceed to test the item in the other axes (before changing the drop height).
- Step 8. If the test item integrity is preserved, select the next drop height.
- Step 9. Repeat steps 5 through 8 until the test objectives have been met.
- Step 10. Document the results correlating the drop height with the measurement variable selected to define the fragility level. If the test item is damaged in one axis during test then replace the test item with an identically configured test item and proceed in testing starting at Step 4.
- b. Synthesized Pulse. This part of the procedure assumes that the fragility level is some function of the peak acceleration level determined from a maximax acceleration SRS of a complex transient. For a complex transient specified in the time domain this procedure could use the peak acceleration of the time history to define the fragility level.
- Step 1. Mount the calibration load to the test apparatus in a configuration similar to that of the actual test item. Use a fixture similar in configuration to the interface of the shock attenuation system (if any) that will support the materiel. The fixture should be as rigid as possible to prevent distortion of the shock pulse input to the test item.
- Step 2. Perform calibration shocks until two consecutive shock applications to the calibration load reproduce maximax acceleration SRS that are within the specified test tolerances. If response to the calibration shock is nonlinear with respect to shock input level then other test procedures may need to be applied to establish materiel fragility levels depending upon the extent of the nonlinearity prior to reaching the "stress threshold".
- Step 3. Select a peak maximax acceleration SRS level low enough to assure that no damage will occur.

- Step 4. Mount the test item in the fixture. Inspect and functionally test the item to document the pre-test condition.
- Step 5. Perform the shock test at the selected level and examine the recorded data to assure the test maximax acceleration SRS is within tolerance.
- Step 6. Visually examine and functionally test the materiel to determine if damage has occurred. If damage is found or pre-established goals have been reached, go to Step 10.
- Step 7. If it is required to determine the fragility of the test item in more than one axis then proceed to test the item in the other axes (before changing the peak maximax acceleration SRS level).
- Step 8. If the test item integrity is preserved, select the next predetermined peak maximax acceleration SRS level.
- Step 9. Repeat steps 5 through 8 until the test objectives have been met.
- Step 10. Document the results recording the peak maximax acceleration SRS to define the fragility level. If the test item is damaged in one axis during test, then replace the test item with an identically configured test item and proceed in testing starting at Step 4.

4.5.4.4 Analysis of results.

Refer to the guidance in Part One, paragraph 5.14, to assist in the evaluation of the test results. The outcome of a successful fragility test is one specified measurement level of test item failure to each test axis. Consider that if the test item fails either functionally or structurally at the lowest level of testing and there is no provision for testing at lower levels, then the test item's fragility level is indeterminate.

4.5.5 Procedure IV - Transit Drop.

The intent of this test is to determine the structural and functional integrity of the materiel to a transit drop in its transit or combination case. Perform all tests with a quick release hook or drop tester. In general, there is no instrumentation calibration for the test and measurement information is minimized, however, if measurements are made, the maximax acceleration SRS and the pseudovelocity SRS will define the results of the test, along with the measurement amplitude time history.

4.5.5.1 Controls.

Test levels for this test are shown in table 516.5-VI. Test the item in the same configuration that is used in a transportation, handling or a combat situation. For test items under 45kg (100 pounds), the 26-drop requirement (table 516.5-VI) may be divided among up to five samples of the same test item in any combination. Toppling of the item following impact will occur in the field and, therefore, toppling of the test item following its initial impact should not be restrained as long as the test item does not leave the required drop surface. Levels for this test were set by considering how materiel in the field might commonly be dropped. (For example, a light item might be carried by one man, chest high; thus it could drop 122 cm (48 inches).) Field data have shown that a typical piece of man-portable materiel will be dropped from heights up to 122 cm an average of four to six times during its life cycle. The 26-drop requirement exists to ensure each vulnerable position (faces, edges, and corners) of a typical test item receives an impact.

4.5.5.2 Test tolerances.

Ensure the test height of drop is within 2.5% of the height of drop as specified in table 516.5-VI.

4.5.5.3 Procedure IV.

- Step 1. After performing a visual inspection and operational check for baseline data, install the test item in its transit or combination case as prepared for field use (if measurement information is to be obtained, install and calibrate such instrumentation in this step.)
- Step 2. From paragraph 4.5.5.1 and table 516.5-VI, determine the height of the drops to be performed, the number of drops per test item, and the drop surface.

MIL-STD-810F
1 January 2000

- Step 3. Perform the required drops using the apparatus and requirements of paragraph 4.5.5.1 and table 516.5-VI notes. Recommend visually and/or operationally checking the test item periodically during the drop test to simplify any follow-on failure evaluation that may be required.
- Step 4. Document the impact point or surface for each drop and any obvious damage.
- Step 5. Following completion of the required drops, visually examine the test item(s).
- Step 6. Document the results.
- Step 7. Conduct an operational checkout in accordance with the approved test plan.
- Step 8. Document the results for comparison with data obtained in Step 1, above (if measurement information was obtained during the drop examine the time history traces and process them in this step according to procedures outlined in the test plan).

4.5.5.4 Analysis of results.

Refer to the guidance in Part One, paragraph 5.14, to assist in the evaluation of the test results. In general, analysis of results will consist of visual and operational comparisons for before test and after test. Measurement instrumentation and subsequent processing of acceleration time history information can provide valuable information related to response characteristics of the test item and statistical variation in the shock environment.

4.5.6 Procedure V - Crash Hazard.

The intent of this procedure is to disclose structural failures of materiel or mounts for materiel in air or ground vehicles that may present a hazard to personnel or other materiel if the materiel breaks loose from its mount during or after a vehicle crash. The test in this procedure is intended to verify that materiel mounting and/or restraining devices will not fail, and that sub-elements are not ejected during crash situations. Attach the test item to its shock fixture by its in-service mounting or tiedowns.

4.5.6.1 Controls.

Use figure 516.5-8 as the test spectrum for the axis of test with the effective shock duration, T_e , between 15 and 23 milliseconds for flight materiel, and between 8 and 13 milliseconds for ground materiel. If shock spectrum analysis capabilities are not available, the classical terminal peak sawtooth pulse on figure 516.5-10 may be used as an alternative to a complex transient waveform developed from the SRS on figure 516.5-8. Table 516.5-VII provides the parameters for the terminal peak sawtooth pulse. An aircraft crash level of 40 g's is based on the assumption that, during a survivable crash, localized g levels can approach 40 g's. Ground transportation vehicles are designed with a higher safety factor and, therefore, must sustain a much higher g level with correspondingly higher specified test levels.

TABLE 516.5-VI. Transit drop test.

| Weight of Test Item & Case kg (lbs) | Largest Dimension, cm (in) | Notes | Height of Drop, h cm (in) | Number of Drops |
|---|----------------------------|-----------|---------------------------|---|
| Under 45.4 (100) Manpacked or man-portable | Under 91 (36) | <u>A/</u> | 122 (48) | Drop on each face, edge and corner; total of 26 drops <u>D/</u> |
| | 91 & over | <u>A/</u> | 76 (30) | |
| 45.4 - 90.8 (100 - 200) inclusive | Under 91 | <u>A/</u> | 76 (30) | Drop on each corner; total of eight drops |
| | 91 & over | <u>A/</u> | 61 (24) | |
| 90.8-454 (200 - 1000) inclusive | Under 91 | <u>A/</u> | 61 (24) | |
| | 91 - 152 (36 - 60) | <u>B/</u> | 61 (24) | |
| | Over 152 | <u>B/</u> | 61 (24) | |
| Over 454 | No limit | <u>C/</u> | 46 (18) | Drop on each bottom edge. Drop on bottom face or skids; total of five drops |

NOTES:

A/ Perform drops from a quick-release hook or drop tester. Orient the test item so that, upon impact, a line from the struck corner or edge to the center of gravity of the case and contents is perpendicular to the impact surface.

B/ With the longest dimension parallel to the floor, support the transit, or combination case with the test item within, at the corner of one end by a block 13 cm (five inches) in height, and at the other corner or edge of the same end by a block 30 cm (12 inches) in height. Raise the opposite end of the case to the specified height at the lowest unsupported corner and allow it to fall freely.

C/ While in the normal transit position, subject the case and contents to the edgewise drop test as follows (if the normal transit position is unknown, orient the case so the two longest dimensions are parallel to the floor):

Edgewise drop test: Support one edge of the base of the case on a sill 13-15 cm (five to six inches) in height. Raise the opposite edge to the specified height and allow it to fall freely. Apply the test once to each edge of the base of the case (total of four drops).

D/ If desired, divide the 26 drops among no more than five test items (see paragraph 4.5.5.1).

TABLE 516.5-VII. Terminal peak sawtooth pulse test parameters (refer to figure 516.5-10).

| Test | Minimum Peak Value (P) g's | | Nominal Duration (T _D) ms | |
|--------------|--|--------------------|--|--------------------|
| | Flight Vehicle Equipment ^{1/} a | Ground Equipment b | Flight Vehicle Equipment ^{1/} c | Ground Equipment d |
| Crash Hazard | 40 | 75 | 11 | 6 |

^{1/} Shock parameters a and c : Recommend for materiel not shock-mounted and weighing less than 136 kg (300 lbs).

MIL-STD-810F
1 January 2000

4.5.6.2 Test tolerances.

For complex waveform replication based upon SRS, ensure the test tolerances are within those specified for the SRS in paragraph 4.2.2. For the classical pulse terminal peak sawtooth pulse described in table 516.5-VII, ensure the waveform is within the tolerances specified on figure 516.5-10.

4.5.6.3 Procedure V.

- Step 1. Secure the test item mount to the shock apparatus by its in-service mounting configuration. Use a test item that is dynamically similar to the materiel, or a mechanically equivalent mockup. If a mockup is used, it will represent the same hazard potential, mass, center of mass, and mass moments about the attachment points as the materiel being simulated. (If measurement information is to be collected, mount and calibrate the instrumentation.)
- Step 2. Perform two shocks in each direction (as determined in paragraph 2.3.3) along three orthogonal axes of the test item for a maximum of 12 shocks.
- Step 3. Perform a physical inspection of the test setup. Operation of the test item is not required.
- Step 4. Document the results of the physical inspection including an assessment of potential hazards created by either materiel breakage or structural deformation or both. Process any measurement data according to the maximax acceleration SRS or the pseudovelocity SRS.

4.5.6.4 Analysis of results.

Refer to the guidance in Part One, paragraphs 5.14 and 5.17, to assist in the evaluation of the test results. If measurement information was obtained process this in accordance with paragraph 4.5.6.3, Step 4.

4.5.7 Procedure VI - Bench handling.

The intent of this test is to determine the ability of materiel to withstand the usual level of shock associated with typical bench maintenance or repair. Use this test for any materiel that may experience bench or bench-type maintenance. This test considers both the structural and functional integrity of the materiel.

4.5.7.1 Controls.

Ensure the test item is a fully functional representative of the materiel. Raise the test item at one edge 100 mm (4 in) above a solid wooden bench top or until the chassis forms an angle of 45° with the bench top or until point of balance is reached, whichever is less. (The bench top must be at least 4.25 cm (1.675 inches) thick.) Perform a series of drops in accordance with specifications. The heights used during this test are defined by examining the typical drops that are commonly made by bench technicians and assembly line personnel.

4.5.7.2 Test tolerances.

Ensure the test height of drop is within 2.5% of the height of drop as specified in paragraph 4.5.7.1.

4.5.7.3 Procedure VI.

- Step 1. Following a functional and physical checkout, configure the item as it would be for servicing, e.g., with the chassis and front panel assembly removed from its enclosure. Position the test item as it would be for servicing. Generally, the test item will be non-operational during the test.
- Step 2. Using one edge as a pivot, lift the opposite edge of the chassis until one of the following conditions occurs (whichever occurs first).
 - a. The lifted edge of the chassis has been raised 100 mm (4 in) above the horizontal bench top.
 - b. The chassis forms an angle of 45° with the horizontal bench top.
 - c. The lifted edge of the chassis is just below the point of perfect balance. Let the chassis drop back freely to the horizontal bench top. Repeat using other practical edges of the same horizontal face as pivot points, for a total of four drops.
- Step 3. Repeat Step 2 with the test item resting on other faces until it has been dropped for a total of four times on each face on which the test item could be placed practically during servicing.
- Step 4. Visually inspect the test item.

- Step 5. Document the results.
- Step 6. Operate the test item in accordance with the approved test plan.
- Step 7. Document the results for comparison with data obtained in step 1, above.

4.5.7.4 Analysis of results.

Refer to the guidance in Part One, paragraph 5.14, to assist in the evaluation of the test results. In general, any functional or physical (mechanical or structural) change of configuration from Step 1 in paragraph 4.5.7.3 must be recorded and analyzed.

4.5.8 Procedure VII - Rail impact.

4.5.8.1 Controls.

The Department of Defense (DoD) uses this test to determine the effect of normal railroad car impacts that occur during rail shipment, to verify the structural integrity of the materiel, and to evaluate the adequacy of the tiedown system and the tiedown process.

- a. Test facility/equipment.
 - (1) Buffer railcars. Empty cars are preferred for use as the buffer or struck cars. However, loaded cars may also be used with prior approval by the Director, Military Traffic Management Command Transportation Engineering Agency (MTMCTEA), ATTN: MTTE-DPE, 720 Thimble Shoals Blvd., Suite 130, Newport News, VA 23606-2574. (MTMCTEA is the designated DoD agent for land transportation (AR 70-44).) In either case, the total weight of the buffer cars is to be at least 113,400 kg (250,000 lbs). The first buffer car must be a standard draft gear car. The remaining buffer cars should have standard draft gear, if possible. The following are required to perform the rail impact test:
 - (2) A test railcar, equipped with chain tiedowns and end-of-car cushioned draft gear, unless other railcar types are approved by MTMCTEA. Some materiel may require other types of railcars for testing to be representative of the intended shipping methods.

NOTE: Cushioned draft gear is a significant change from previous equipment requirements.

- (3) One locomotive.
- (4) A minimum 61 m (200 ft) length of reasonably level, tangent track is required between the buffer cars and test car to allow acceleration of locomotive and test car to specified impact speeds.
- (5) If the alternate procedure (see paragraph 4.5.8.3b) is used to conduct the test, use a tangent track with a slight grade in lieu of a locomotive.
- b. Preparation for test.
 - (1) Load and secure the test item as would be done for actual rail transport. If safety or other reasons preclude the use of a test item representative of the actual materiel, use a substitute test item that is equal in weight and general character to the materiel. Prior to using a substitute test item, obtain approval from MTMCTEA.
 - (2) The materiel developer is responsible for the development of transportation procedures and instructions and is responsible for coordinating these with and obtaining approval from MTMCTEA well in advance of rail impact testing. Mount the test item as would be done in actual service and in accordance with the standard loading and bracing methods shown in Section No. 6 of the Rules Governing the Loading of Department of Defense Materiel on Open Top Cars (procure copies from the Publications Department, Association of American Railroads, 50 F Street N. W., Washington, DC 20001-1530, (202) 639-2211). Do not use more than four tiedown provisions, typically two at each end of the test item. Apply the first tiedown from each provision as near as possible to, but without exceeding 45 degrees from the horizontal (when viewed from the side). Apply additional tiedowns to the next available tiedown point on the flatcar. Apply chains to the railcar near side (do not cross chains). All tiedown procedures require approval by MTMCTEA prior to testing. Only

MIL-STD-810F
1 January 2000

use an arrangement of the test item and its blocking and tiedown to be tested that is identical to that proposed or approved by MTMCTEA.

- (3) Unless otherwise specified in the transportability requirements for the materiel, perform the test with the test item at its maximum gross weight (fully loaded) rating.

c. Test setup.

- (1) Buffer cars must have their air and hand brakes set. This provides a more conservative test. Cars must be bunched to compress all slack and cushioning in the couplings, if any. The struck end of first buffer car must have standard draft gear.
- (2) Locate the test car between the buffer cars and the locomotive.
- (3) Install one of the following timing devices (or equivalent) to obtain the impact speed of the test car.
 - (a) An electric timer capable of measuring within 0.16 km/h (± 0.1 mph): Place the switch contacts on the track in accordance with manufacturer's instructions.
 - (b) A stop watch and torpedoes: when used, measure the torpedo locations. Place the first torpedo beyond the face of the knuckle on the first buffer car and located one foot more than the distance between the leading axle and knuckle face on the test car. Place the second torpedo 6.7 m (22 ft) along the track from the first torpedo. The relationship of time lapse versus speed for travel of a distance of 6.7 m (22 ft) is shown in table 516.5-VIII.
 - (c) Radar: In order to obtain an accurate speed, position the operator of the radar in line with the direction of impact or as otherwise recommended by the radar manufacturer.
- (4) Photograph the test setup including any securement items. This may be a valuable tool if there is any subsequent failure of the items of securement.

4.5.8.2 Test tolerances.

Ensure test tolerances are in accordance with tolerances specified in paragraph 4.5.8.1 and the test plan.

4.5.8.3 Procedure VII.

a. General considerations for main procedure.

- (1) Brief the train crew on the procedure. Delegate one person to advise the appropriate member of the train crew when moves are to be made. Instruct all participants and observers to take precautions for their personal safety and observe safety practices of the carrier and/or company conducting the test. If desired, perform a test run without impacting the test item to establish accuracy of speed.
- (2) Subject the test item to four impacts, the first three of which are in the same direction and at speeds of 6.4, 9.7, and 13 km/h (4, 6, and 8 mph) respectively, each speed with a tolerance of +0.8, -0.0 km/h (0.5 mph).
- (3) Perform the fourth impact at 13 km/h (+0.8, -0.0 km/h) and impact the opposite end of the test car from the first three impacts. If it is not possible to turn the test car because of track layout, this may be accomplished by running the test item car to the opposite end of the buffer cars and impacting as above.
- (4) If the lading or securement items loosen or fail during the test, photograph and document these items. If it appears necessary to adjust the lading or securement items to continue the test, correct the restraint and restart the test beginning with the 6.4 km/h (4 mph) impact.
- (5) Pull the rail car carrying the test item a sufficient distance from the buffer cars. Next, push the test load car toward the buffer cars until the desired speed is obtained, and release it so it rolls freely into the buffer cars having knuckles positioned for coupling.
- (6) If the materiel can be shipped in two orientations (such as lengthwise and crosswise on the rail car), repeat the four impacts for each orientation.

b. General considerations for alternate procedure.

- (1) A section of track can be calibrated using a test car and either radar or another speed-measuring device. Release the test car from the designated starting point and allow it to roll freely down the inclined track. For radar, a crew member riding the test car is in radio contact with the radar operator who reads off the car speed to the rider. For other than radar, follow the same concept. The rider drops markers at track-side to indicate locations at which the desired speeds are obtained. After determining the 8 mph mark, stop the test car by use of the hand brake. Ensure no other cars are present on the test track during the calibration process. Repeat the process two times to ensure the accuracy of speed locations. If it is difficult for the rider to safely drop the markers and stop the car using the hand brake, use a free rolling locomotive for the initial calibration when markers are dropped with the locomotive's brakes applied after reaching 8 mph as indicated by radar. Then release the test car from the same starting point and make adjustments in markers if needed prior to impacting.
 - (2) After determining speed locations, perform impacts by locating the buffer cars at the proper location for desired impact speed and releasing the test car from the designated starting point. This requires moving the buffer cars every time a different speed is required.
 - (3) Use speeds and the direction of impacts as outlined in paragraph 4.5.8.3a.
 - (4) In lieu of positioning of the buffer cars at various positions on the track, release the test car from calibrated positions on the inclined track that correspond to the desired speeds.
 - (5) If the lading or securement items loosen or fail during the test, photograph and document these items. If it appears necessary to adjust the lading or securement items to continue the test, correct the restraint and restart the test beginning with the 6.4 km/h impact.
- c. Additional requirements.
- (1) Repeat any impacts that are below the required test speeds. If any readjustment of the lading or reconditioning of the bracing or items of securement is necessary, correct, photograph and document the problem(s), correct the restraint and restart the entire test beginning with the 6.4 km/h impact. Accept any impacts above the required test speed providing the test item satisfies the requirements of paragraph 4.5.8.4.
 - (2) If the tiedown chains or chock blocks become loose during the test, photograph and document the problem(s). The test director will notify MTMCTEA of the modifications required, and jointly decide if a retest will be required.

MIL-STD-810F
1 January 2000

TABLE 516.5-VIII. Impact test time speed (miles per hour - based on 22'0" rail).

| TIME SPEED SECS. MPH | TIME SPEED SECS. MPH | TIME SPEED SECS. MPH | TIME SPEED SECS. MPH |
|---------------------------------|---------------------------------|---------------------------------|---------------------------------|
| 1.0 - 15.0 | 4.0 - 3.8 | 7.0 - 2.1 | 10.0 - 1.5 |
| 1.1 - 13.6 | 4.1 - 3.7 | 7.1 - 2.1 | 10.1 - 1.5 |
| 1.2 - 12.5 | 4.2 - 3.6 | 7.2 - 2.1 | 10.2 - 1.5 |
| 1.3 - 11.5 | 4.3 - 3.5 | 7.3 - 2.0 | 10.3 - 1.5 |
| 1.4 - 10.7 | 4.4 - 3.4 | 7.4 - 2.0 | 10.4 - 1.4 |
| 1.5 - 10.0 | 4.5 - 3.3 | 7.5 - 2.0 | 10.5 - 1.4 |
| 1.6 - 9.4 | 4.6 - 3.3 | 7.6 - 2.0 | 10.6 - 1.4 |
| 1.7 - 8.8 | 4.7 - 3.2 | 7.7 - 1.9 | 10.7 - 1.4 |
| 1.8 - 8.3 | 4.8 - 3.1 | 7.8 - 1.9 | 10.8 - 1.4 |
| 1.9 - 7.9 | 4.9 - 3.1 | 7.9 - 1.9 | 10.9 - 1.4 |
| 2.0 - 7.5 | 5.0 - 3.0 | 8.0 - 1.9 | 11.0 - 1.4 |
| 2.1 - 7.1 | 5.1 - 2.9 | 8.1 - 1.9 | 11.1 - 1.4 |
| 2.2 - 6.8 | 5.2 - 2.9 | 8.2 - 1.8 | 11.2 - 1.3 |
| 2.3 - 6.5 | 5.3 - 2.8 | 8.3 - 1.8 | 11.3 - 1.3 |
| 2.4 - 6.3 | 5.4 - 2.8 | 8.4 - 1.8 | 11.4 - 1.3 |
| 2.5 - 6.0 | 5.5 - 2.7 | 8.5 - 1.8 | 11.5 - 1.3 |
| 2.6 - 5.8 | 5.6 - 2.7 | 8.6 - 1.7 | 11.6 - 1.3 |
| 2.7 - 5.6 | 5.7 - 2.6 | 8.7 - 1.7 | 11.7 - 1.3 |
| 2.8 - 5.4 | 5.8 - 2.6 | 8.8 - 1.7 | 11.8 - 1.3 |
| 2.9 - 5.2 | 5.9 - 2.5 | 8.9 - 1.7 | 11.9 - 1.3 |
| 3.0 - 5.0 | 6.0 - 2.5 | 9.0 - 1.7 | 12.0 - 1.3 |
| 3.1 - 4.8 | 6.1 - 2.5 | 9.1 - 1.6 | 12.1 - 1.2 |
| 3.2 - 4.7 | 6.2 - 2.4 | 9.2 - 1.6 | 12.2 - 1.2 |
| 3.3 - 4.5 | 6.3 - 2.4 | 9.3 - 1.6 | 12.3 - 1.2 |
| 3.4 - 4.4 | 6.4 - 2.3 | 9.4 - 1.6 | 12.4 - 1.2 |
| 3.5 - 4.3 | 6.5 - 2.3 | 9.5 - 1.6 | 12.5 - 1.2 |
| 3.6 - 4.2 | 6.6 - 2.3 | 9.6 - 1.6 | 12.6 - 1.2 |
| 3.7 - 4.0 | 6.7 - 2.2 | 9.7 - 1.5 | 12.7 - 1.2 |
| 3.8 - 3.9 | 6.8 - 2.2 | 9.8 - 1.5 | 12.8 - 1.2 |
| 3.9 - 3.8 | 6.9 - 2.2 | 9.9 - 1.5 | 12.9 - 1.2 |

NOTE: Cargo requiring extraordinary attention, e.g., nuclear, one-of-a-kind, high value, or key military materiel, may justify changes to the test procedure and criteria; the developer or Program Manager must identify these, and they must be approved by the Director, Military Traffic Management Command Transportation Engineering Agency (MTMCTEA), ATTN: MTTE-DPE, 720 Thimble Shoals Blvd., Suite 130, Newport News, VA 23606-2574 (or its European equivalent).

4.5.8.4 Analysis of results.

Refer to the guidance in Part One, paragraphs 5.14 and 5.17, to assist in the evaluation of the test results. The test item fails this test if the test item or any item that is attached to it, or that is included as an integral part of the test item, breaks free, loosens, or shows any sign of permanent deformation beyond specification tolerances. Likewise, the test item and its subassemblies must be operationally effective after the test. If tiedown securement items break or displace substantially, photograph and document the problem areas for evaluation of the procedures and materials used. The test director and MTMCTEA jointly decide if any failed securement items require reconfiguring and, if so, whether a complete retest is required. If the test item fails, the necessary required action will be determined jointly by the parties involved. For retests, use new tiedown material to eliminate additive effects and, if possible, a new test item.

4.5.9 Procedure VIII - Catapult Launch/Arrested Landing.

The intent of this test is to verify the functionality and structural integrity of materiel mounted in or on fixed wing aircraft that are subject to catapult launches and arrested landings.

4.5.9.1 Controls.

- a. Measured data not available. Whenever possible, derive the test conditions from measured data on applicable carrying aircraft (see Part One, paragraph 5.6, as well as the tasks at the end of Part One in Appendix A for information on the use of field/fleet data), since shock responses can be affected by local influences such as wing and fuselage bending modes, pylon interfaces, and structural damping. While the pulse amplitudes associated with this environment are generally low, the long periods of application and high frequency of occurrence have the potential to cause significant dynamic and/or low cycle fatigue damage in improperly designed materiel. A typical aircraft may fly as many as 200 sorties per year, of which more than two-thirds involve catapult launches and arrested landings. However, for laboratory test purposes, 30 simulated catapult/arrested landing events in each of two axes (longitudinal and vertical) should provide confidence that the majority of significant defects will be identified for remedial action. If acceptable field-measured data are not available, the following guidance is offered in which sinusoidal burst is used to simulate each catapult or launch event. This time history has been simplified to a constant amplitude sine burst of 2-second duration for simulation. In paragraph 4.5.9.1a(5) measured data seems to indicate that response in the horizontal direction can be comparable to that in the vertical direction. For testing purposes, it is permissible to reduce the maximum amplitude in the horizontal direction to 75% of that in the vertical direction.
 - (1) Wave shape: damped sine wave.
 - (2) Wave frequency: determined by structural analysis of the specific aircraft and frequency of the fundamental mode.
 - (3) Burst amplitude: determined by structural analysis of the specific aircraft, the frequency of the fundamental mode and the location of the materiel relative to the shape of the fundamental mode.
 - (4) Wave damping (quality factor): $Q = 20$.
 - (5) Axis: vertical, horizontal, longitudinal.
 - (6) Number of bursts: determined by the specific application (for example, 30 bursts, each followed by a 10 second rest period).
- b. Measured data available. If acceptable field measured data are available, the following guidance is offered in which the catapult event is simulated by two shocks separated by a transient vibration, and the arrested landing event by one shock followed by transient vibration. The catapult launch/arrested landing shock environment differs from other typical shock events in that it is a transient periodic vibration (roughly sinusoidal) at a relatively low frequency determined by aircraft mass and landing gear damping characteristics. Typical catapult launch shock time histories are shown on figure 516.5-12. These data represent measured acceleration response in the vertical, horizontal and longitudinal directions of a store component mounted on the pylon of a platform. The data are DC coupled and lowpass filtered at 70 Hz. All three time histories demonstrate an initial transient, followed by a transient vibration (nearly two seconds long), and concluded by a final transient. The longitudinal axis provides a profile of the DC catapult acceleration which in general will not be important for testing purposes and can be removed by high pass filtering the time history at a frequency less than 10% of the lowest significant frequency in the maximax acceleration SRS. Procedures for accomplishing this filtering may necessarily be iterative (unless Fourier transform information is used) with high pass filtering beginning at a comparatively high frequency and decreasing until the most significant SRS low frequency is identified. In general, catapult acceleration response will display two shock events corresponding to initial catapult load application to the aircraft and catapult release from the aircraft separated by an oscillatory acceleration. Both the initial and the final shock events have a distinct oscillatory nature. It is essential that this test be run as a series of two shock transients separated by a two second period of time in which transient vibration may be input. Typical arrested landing shock time histories are shown on figure 516.5-13. These data represent

MIL-STD-810F
1 January 2000

measured acceleration response in the vertical, horizontal and longitudinal directions of a store component mounted on the pylon of a platform. The data are DC coupled and low pass filtered at 70 Hz. All three time histories demonstrate an initial transient, followed by a transient vibration (nearly three seconds long). It is clear that the longitudinal time history has a comparatively large DC component that may be filtered out for test specification development. The term 'transient vibration' is introduced here because of the duration of the event being not typical of a shock event.

Note : Transient vibrations. For precise laboratory simulation Procedure VIII may require consideration of the concept of a transient vibration in processing and replication of the form of time history from measured data. For long duration transient environments (durations on the order of one second or more), it may be useful to process the response time history by estimating the envelope function, $a(t)$, and proceeding to compute a maximax Autospectral Density Estimate (ASD), assuming short portions of the response time history behave in the same manner as stationary random data. Estimation of this form falls under the category of nonstationary time history processing and will not be considered further in this method. For a precise definition of transient vibration see Part One, Appendix D. The importance of the transient vibration phenomenon is that (1) it has the form of a shock (short duration and substantial time varying amplitude), (2) it can be mathematically modeled in a precise way, and (3) it can be used in stochastic simulation of certain shock environments. In general, shocks have their significant energy in a shorter time frame than transient vibrations, while transient vibrations allow for time history enveloping functions other than the exponential envelope form often times displayed in shocks as a result of resonant response decay to an impact.

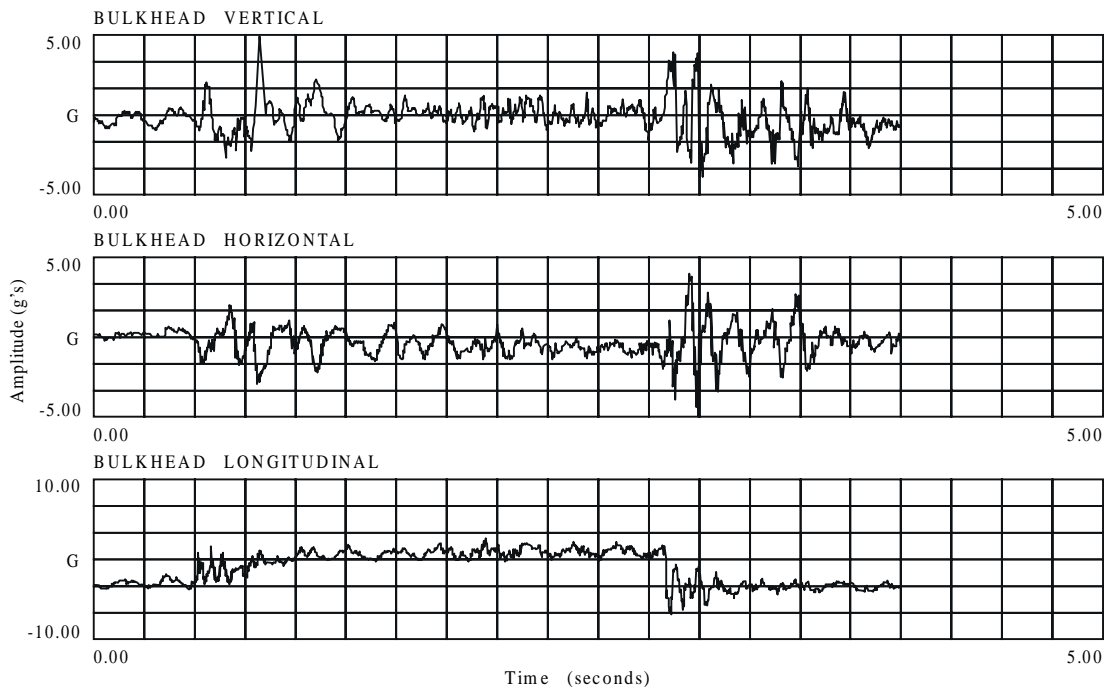

FIGURE 516.5-12. Sample measured store three axis catapult launch component response acceleration time histories.

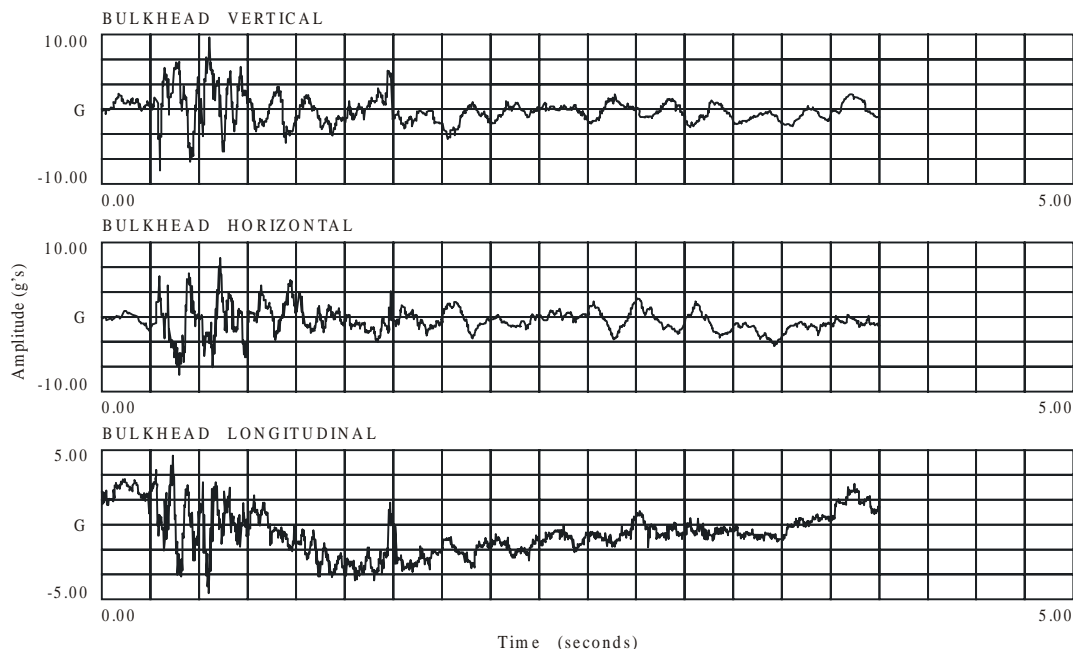

FIGURE 516.5-13. Sample measured store three axis arrested landing component response acceleration time histories.

4.5.9.2 Test tolerances.

For cases in which measured data are not available and waveforms are generated from dynamic analysis of the configuration, ensure the waveform tolerances are within the time history test tolerances specified for waveforms in paragraph 4.2.2. For cases in which measured data are available, ensure the SRS for the test response is within the SRS tolerances specified in paragraph 4.2.2. For transient vibration, ensure the waveform peaks and valleys are within the tolerances given for waveforms in paragraph 4.2.2 or as provided in the test specification.

4.5.9.3 Procedure VIII.

- Step 1. Mount the test item to its shock/vibration fixture on the shock device for the first test axis.
- Step 2. Attach instrumentation as required in the approved test plan.
- Step 3. Conduct an operational checkout and visual examination in accordance with the approved test plan.
- Step 4.
 - a. If no measured field data are available, apply short transient sine waves of several cycles to the test item in the first test axis. (Each short transient sine wave of several cycles represents a single catapult or arrested landing event.) Follow each burst by a rest period to prevent unrepresentative effects. Operate the test item in its appropriate operational mode while bursts are applied.
 - b. If measured field data are available, either apply the measured response data under shaker system wave form control (see method 519.5, Annex A), or process the catapult as two shocks separated by a transient vibration, and the arrested landing as a shock followed by a transient vibration.
- Step 5. If the test item has not malfunctioned during testing, conduct an operational checkout and visual examination in accordance with the approved test plan. If a failure has occurred, it may be desirable to perform a thorough visual examination before proceeding with the operational checkout to avoid initiating additional hardware damage. When a failure occurs, consider the nature of the failure and corrective action along with the purpose of the test (engineering information or contractual compliance) in determining whether to restart the test or to continue from the point of interruption.
- Step 6. Repeat steps 1 through 5 for the second test axis.
- Step 7. Document the test including amplitude time history plots, and notes of any test item functional or structural degradation.

MIL-STD-810F
1 January 2000

4.5.9.4 Analysis of results.

In addition to the guidance in Part One, paragraphs 5.14 and 5.17, and Part One, Appendix A, Tasks 405 and 406, in the evaluation consider any failure of the structural configuration of the test item, mount or launcher that may not directly impact failure of the functioning of the materiel but that would lead to failure under in-service conditions.

5. REFERENCE/RELATED DOCUMENTS.

- a. Harris, C., and C. E. Crede, eds. Shock and Vibration Handbook, 2nd Edition, NY, McGraw-Hill, 1976.
- b. Gaberson, H. A. and R. H. Chalmers. Model Velocity as a Criterion of Shock Severity, Shock and Vibration Bulletin 40, Pt. 2, (1969) 31-49.
- c. ANSI/ASTM D3332-77, Standard Methods for Fragility of Products Using Machines. 1977.
- d. Conover, W.J., Practical Nonparametric Statistics. New York; Wiley, 1971, Chapter 3.
- e. Piersol, A.G., Analysis of Harpoon Missile Structural Response to Aircraft Launches, Landings and Captive Flight and Gunfire. Naval Weapons Center Report #NWC TP 58890. January 1977.
- f. Handbook for Dynamic Data Acquisition and Analysis, IES-RP-DTE012.1, Institute of Environmental Sciences, 940 East Northwest Highway, Mount Prospect, Illinois 60056
- g. Piersol, Allan G., Determination of Maximum Structural Responses From Predictions or Measurements at Selected Points, Proceedings of the 65th Shock and Vibration Symposium, Volume I, SAVIAC, 1994.
- h. Bendat, J. S. and A. G. Piersol, Random Data: Analysis and Measurement Procedures, John Wiley & Sons Inc., New York, 1986
- i. Schock, R. W. and W. E. Paulson, TRANSPORTATION A Survey of Shock and Vibration Environments in the Four Major Modes of Transportation, Shock and Vibration Bulletin #35, Part 5, February 1966.
- j. Ostrem, F. E., TRANSPORTATION AND PACKAGING A Survey of the Transportation Shock and Vibration Input to Cargo, Shock and Vibration Bulletin #42, Part 1, January 1972.
- k. MIL-S-901, "Shock Tests, H.I. (High Impact), Shipboard Machinery, Equipment and Systems, Requirements for."
- l. MIL-STD-331, "Fuze and Fuze Components, Environmental and Performance Tests for."

ANNEX A

STATISTICAL CONSIDERATIONS FOR DEVELOPING LIMITS ON PREDICTED AND PROCESSED DATA

1. SCOPE.

1.1 Purpose.

This Annex provides information relative to the statistical characterization of a set of data for the purpose of defining an upper limit of the data set related to statistical/probabilistic considerations.

1.2 Application.

Information in this Annex is generally applicable to frequency domain estimates that are either predicted based on given information or time domain measurements processed in the frequency domain according to an appropriate technique i.e., for stationary random vibration the processing would be an ASD, for a very short transient the processing could be an SRS, ESD, or FS. Given estimates in the frequency domain information in this Annex will allow the establishment of upper limits of the data in a statistically correct way.

2. DEVELOPMENT.

2.1 Basic Estimate Assumptions.

Prediction estimates, measurement estimates, or a combination of prediction and measurement estimates may be considered in the same manner. It is assumed that uncertainty in individual measurements (processing error) does not effect the limit considerations. For measured field data digitally processed such that estimates of the SRS, ESD, FS, or ASD are obtained for single sample records, it becomes useful to examine and summarize the overall statistics of "similar" estimates selected in a way so as to not bias the summary statistics. To ensure the estimates are not biased, the measurement locations might be chosen randomly, consistent with the measurement objectives. Similar estimates may be defined as (1) estimates at a single location on materiel that has been obtained from repeated testing under essentially identical experimental conditions; (2) estimates on a system that have been obtained from one test, where the estimates are taken (a) at several neighboring locations displaying a degree of response homogeneity or (b) in "zones" i.e., points of similar response at varying locations; or (3) some combination of (1) and (2). In any case, it is assumed that there is a certain degree of homogeneity among the estimates across the frequency band of interest. This latter assumption generally requires that (1) the set of estimates for a given frequency have no significant "outliers" that can cause large sample variance estimates and (2) larger input stimulus to the system from which the measurements are taken implies larger estimate values.

2.2 Basic Estimate Summary Preprocessing.

There are two ways in which summaries may be obtained. The first way is to utilize an "enveloping" scheme on the basic estimates to arrive at a conservative estimate of the environment, and some qualitative estimate of the spread of basic estimates relative to this envelope. This procedure is dependent upon the judgment of the analyst and, in general, does not provide consistent results among analysts. The second way is to combine the basic estimates in some statistically appropriate way and infer the statistical significance of the estimates based upon probability distribution theory. Reference g summarizes the current state of knowledge relative to this approach and its relationship to determining upper limits on sets of data. In general, the estimates referred to and their statistics are related to the same frequency band over which the processing takes place. Unfortunately, for a given frequency band, the statistics behind the overall set of estimates are not easily accessible because of the unknown distribution function of amplitudes for the frequency band of interest. In most cases the distribution function can be assumed to be normal, provided the individual estimates are transformed to a "normalizing" form by computing the logarithm to the base ten of the estimates. For ESD and FS estimates, the averaging of adjacent components (assumed to be statistically independent) increases the number of degrees of freedom in the estimates while decreasing the frequency

MIL-STD-810F
1 January 2000
ANNEX A

resolution with the possible introduction of statistical bias in the estimates. For ASD estimates, averaging of adjacent components can be useful provided the bias error in the estimate is small; i.e., the resolution filter bandwidth is a very small fraction of the overall estimate bandwidth. For SRS estimates, because they are based on maximum response of a single-degree-of-freedom system as its natural frequency is varied, adjacent estimates tend to be statistically dependent and therefore not well smoothed by averaging unless the SRS is computed for very narrow frequency spacing. In such cases, smoothing of SRS estimates is better accomplished by reprocessing the original time history data at a broader natural frequency spacing, e.g., 1/6th octave as opposed to 1/12th octave. There is no apparent way to smooth dependent SRS estimates mathematically when reprocessing cannot be performed, and the acceptable alternative is some form of enveloping of the estimates. The larger the sample size the closer the logarithm transform of the estimates is to the normal distribution unless there is a measurement selection bias error in the experiment. Finally, it is important to note that generally, before application, the upper limits obtained in the paragraphs to follow are smoothed by straight line segments intersecting at spectrum “breakpoints”. No guidance is provided in this annex relative to this “smoothing” or “enveloping” procedure, e.g., whether estimates should be clipped or enveloped and the relationship of the bandwidth of the estimates to the degree of clipping, etc., except that such smoothing should be performed only by an experienced analyst. Reference g discusses this further.

2.3 Parametric Upper Limit Statistical Estimate Assumptions.

In all the formulas for the estimate of the statistical upper limit of a set of N predictions or measurements,

$$\{ x_1, x_2, \dots, x_N \},$$

it is assumed that (1) the estimates will be logarithm transformed to bring the overall set of measurements closer to those sampled of a normal distribution and (2) the measurement selection bias error is negligible. Since the normal and “t” distribution are symmetric, the formulas below apply for the lower bound by changing the sign between the mean and the standard deviation quantity to minus. It is assumed here that all estimates are at a single frequency or for a single bandwidth, and that estimates among bandwidths are independent so that each bandwidth under consideration may be processed individually, and the results summarized on one plot over the entire bandwidth as a function of frequency. For

$$y_i = \log_{10}(x_i) \quad i = 1, 2, \dots, N$$

Mean estimate for true mean, μ_y is given by

$$m_y = \frac{1}{N} \sum_{i=1}^N y_i$$

and the unbiased estimate of the standard deviation for the true standard deviation σ_y is given by

$$s_y = \sqrt{\frac{\sum_{i=1}^N (y_i - m_y)^2}{N-1}}$$

2.3.1 NTL - Upper normal one-sided tolerance limit.

The upper normal one-sided tolerance limit on the proportion β of population values that will be exceeded with a confidence coefficient, γ , is given by $NTL(N, \beta, \gamma)$, where

$$NTL(N, \beta, \gamma) = 10^{m_y + s_y k_{N, \beta, \gamma}}$$

where $k_{N, \beta, \gamma}$ is the one-sided normal tolerance factor given in table 516.5A-I for selected values of N, β and γ . NTL is termed the upper one-sided normal tolerance interval (of the original set of estimates) for which 100 β % of the values will lie below the limit with 100 γ % confidence. For $\beta = 0.95$ and $\gamma = 0.50$, this is referred to as the 95/50 limit.

The following table from reference g contains the k value for selected N, β , γ . In general this method of estimation should not be used for small N with values of β and γ close to 1 since it is likely the assumption of the normality of the logarithm transform of the estimates will be violated.

TABLE 516.5A-I. Normal tolerance factors for upper tolerance limit.

| N | $\gamma = 0.50$ | | | $\gamma = 0.90$ | | | $\gamma = 0.95$ | | |
|----------|-----------------|----------------|----------------|-----------------|----------------|----------------|-----------------|----------------|----------------|
| | $\beta = 0.90$ | $\beta = 0.95$ | $\beta = 0.99$ | $\beta = 0.90$ | $\beta = 0.95$ | $\beta = 0.99$ | $\beta = 0.90$ | $\beta = 0.95$ | $\beta = 0.99$ |
| 3 | 1.50 | 1.94 | 2.76 | 4.26 | 5.31 | 7.34 | 6.16 | 7.66 | 10.55 |
| 4 | 1.42 | 1.83 | 2.60 | 3.19 | 3.96 | 5.44 | 4.16 | 5.14 | 7.04 |
| 5 | 1.38 | 1.78 | 2.53 | 2.74 | 3.40 | 4.67 | 3.41 | 4.20 | 5.74 |
| 6 | 1.36 | 1.75 | 2.48 | 2.49 | 3.09 | 4.24 | 3.01 | 3.71 | 5.06 |
| 7 | 1.35 | 1.73 | 2.46 | 2.33 | 2.89 | 3.97 | 2.76 | 3.40 | 4.64 |
| 8 | 1.34 | 1.72 | 2.44 | 2.22 | 2.76 | 3.78 | 2.58 | 3.19 | 4.35 |
| 9 | 1.33 | 1.71 | 2.42 | 2.13 | 2.65 | 3.64 | 2.45 | 3.03 | 4.14 |
| 10 | 1.32 | 1.70 | 2.41 | 2.06 | 2.57 | 3.53 | 2.36 | 2.91 | 3.98 |
| 12 | 1.32 | 1.69 | 2.40 | 1.97 | 2.45 | 3.37 | 2.21 | 2.74 | 3.75 |
| 14 | 1.31 | 1.68 | 2.39 | 1.90 | 2.36 | 3.26 | 2.11 | 2.61 | 3.58 |
| 16 | 1.31 | 1.68 | 2.38 | 1.84 | 2.30 | 3.17 | 2.03 | 2.52 | 3.46 |
| 18 | 1.30 | 1.67 | 2.37 | 1.80 | 2.25 | 3.11 | 1.97 | 2.45 | 3.37 |
| 20 | 1.30 | 1.67 | 2.37 | 1.76 | 2.21 | 3.05 | 1.93 | 2.40 | 3.30 |
| 25 | 1.30 | 1.67 | 2.36 | 1.70 | 2.13 | 2.95 | 1.84 | 2.29 | 3.16 |
| 30 | 1.29 | 1.66 | 2.35 | 1.66 | 2.08 | 2.88 | 1.78 | 2.22 | 3.06 |
| 35 | 1.29 | 1.66 | 2.35 | 1.62 | 2.04 | 2.83 | 1.73 | 2.17 | 2.99 |
| 40 | 1.29 | 1.66 | 2.35 | 1.60 | 2.01 | 2.79 | 1.70 | 2.13 | 2.94 |
| 50 | 1.29 | 1.65 | 2.34 | 1.56 | 1.96 | 2.74 | 1.65 | 2.06 | 2.86 |
| ∞ | 1.28 | 1.64 | 2.33 | 1.28 | 1.64 | 2.33 | 1.28 | 1.64 | 2.33 |

2.3.2 NPL - Upper normal prediction limit.

The upper normal prediction limit is the value of x (for the original data set) that will exceed the next predicted or measured value with confidence coefficient γ , and is given by

$$NPL(N, \gamma) = m_y + s_y \sqrt{1 + \frac{1}{N}} t_{N-1; \alpha}$$

where $\alpha = 1 - \gamma$. $t_{N-1; \alpha}$ is the Student t distribution variable with N-1 degrees of freedom at the 100 $\alpha = 100(1-\gamma)$ percentage point of the distribution. This estimate, because of the assumptions behind its derivation, requires careful interpretation relative to measurements made in a given location or over a given zone (reference g).

2.4 Nonparametric Upper Limit Statistical Estimate Assumptions.

If there is some reason to believe that the data after it has been logarithm-transformed will not be sufficiently normally distributed to apply the parametric limits defined above, then consideration must be given to nonparametric limits, i.e., limits that are not dependent upon assumptions concerning the distribution of estimate values. In this case there is no need to transform the data estimates. All of the assumptions concerning the selection of estimates are applicable for nonparametric estimates. With additional manipulation, lower bound limits may be computed.

2.4.1 ENV – Upper limit.

The maximum upper limit is determined by selecting the maximum estimate value in the data set.

$$ENV(N) = \max\{x_1, x_2, \dots, x_N\},$$

MIL-STD-810F
1 January 2000
ANNEX A

The main disadvantage of this estimate is that the distributional properties of the estimate set are neglected so that no probability of exceedance of this value is specified. In the case of outliers in the estimate set, ENV(N) may be far too conservative. ENV(N) is also sensitive to the bandwidth of the estimates.

2.4.2 DFL – Upper distribution-free tolerance limit.

The distribution-free tolerance limit that utilizes the original untransformed sample values is defined to be the upper limit for which at least the fraction β of all sample values will be less than the maximum predicted or measured value with a confidence coefficient of γ . This limit is based on order statistic considerations.

$$DFL(N, \beta, \gamma) = x_{\max}; \gamma = 1 - \beta^N$$

where x_{\max} is the maximum value of the set of estimates, β , is the fractional proportion below x_{\max} , and γ is the confidence coefficient. N , β and γ are not independently selectable. That is

- (1) Given N and assuming a value of β , $0 \leq \beta \leq 1$, the confidence coefficient can be determined.
- (2) Given N and γ , the proportion β can be determined.
- (3) Given β and γ , the number of samples can be determined such that the proportion and confidence can be satisfied (for statistical experiment design).

DFL(N, β, γ) may not be meaningful for small samples of data, $N \leq 13$, and comparatively large β , $\beta > 0.95$. DFL(N, β, γ) is sensitive to the estimate bandwidth.

2.4.3 ETL – Upper empirical tolerance limit.

The empirical tolerance limit uses the original sample values and assumes the predicted or measured estimate set is composed of N measurement points over M frequency resolution bandwidths for a total of NM estimate values. That is

$$\{x_{11}, x_{12}, \dots, x_{1M}; x_{21}, x_{22}, \dots, x_{2M}; x_{N1}, x_{N2}, \dots, x_{NM}\}$$

where m_j is the average estimate at the j th frequency bandwidth over all N measurement points

$$m_j = \frac{1}{N} \sum_{i=1}^N x_{ij} \quad j = 1, 2, \dots, M.$$

m_j is used to construct an estimate set normalized over individual frequency resolution bandwidths. That is

$$\{u\} = \{u_{11}, u_{12}, \dots, u_{1M}, u_{21}, u_{22}, \dots, u_{2M}, u_{N1}, u_{N2}, \dots, u_{NM}\}$$

$$\text{where : } u_{ij} = \frac{x_{ij}}{m_j} \quad i = 1, 2, \dots, N; j = 1, 2, \dots, M$$

The normalized estimate set, $\{u\}$, is ordered from smallest to largest and

$$u_\beta = u_{(k)} \text{ where } u_{(k)} \text{ is the } k^{\text{th}} \text{ ordered element of set } \{u\} \text{ for } 0 < \beta = \frac{k}{MN} \leq 1$$

is defined. For each resolution frequency bandwidth, then

$$ETL(\beta) = u_\beta m_j = x_{\beta j} \quad j = 1, 2, \dots, M$$

Using m_j implies that the value of ETL(β) at j exceeds β % of the values with 50% confidence. If a value other than m_j is selected, the confidence level may increase. It is important that the set of estimates is homogeneous to use this limit, i.e., they have about the same spread in all frequency bands. In general, the number of measurement points, N , should be greater than 10 to apply this limit.

3. EXAMPLE.

3.1 Input Test Data Set.

Table 516.5A-II represents a homogeneous table of normally distributed numbers of unity variance around a mean value of 3.5 with $N=14$ rows and $M=5$ columns (rows could represent fourteen individual test measurements and columns could represent test values over five individual frequency bandwidths). Table 516.5A-II is used in the upper limit determinations in paragraphs 3.2 and 3.3.

3.2 Parametric Upper Limits.

The upper normal one-sided tolerance limit (NTL) is computed as 95/50 limit with 50% confidence that at least 95% of the values will lie below this limit for $k_{N, \beta, \gamma} = 1.68$ from table 516.5A-I. The upper normal prediction limit (NPL) is computed with a 95 confidence coefficient at the 95% point of the distribution where $t_{N-1; \alpha} = t_{13; 0.05} = 1.771$. Figure 516.5A-1 displays the data and figure 516.5A-2 displays the two parametric upper limits. Note the degree of conservativeness in the normal prediction upper limit over the normal tolerance limit.

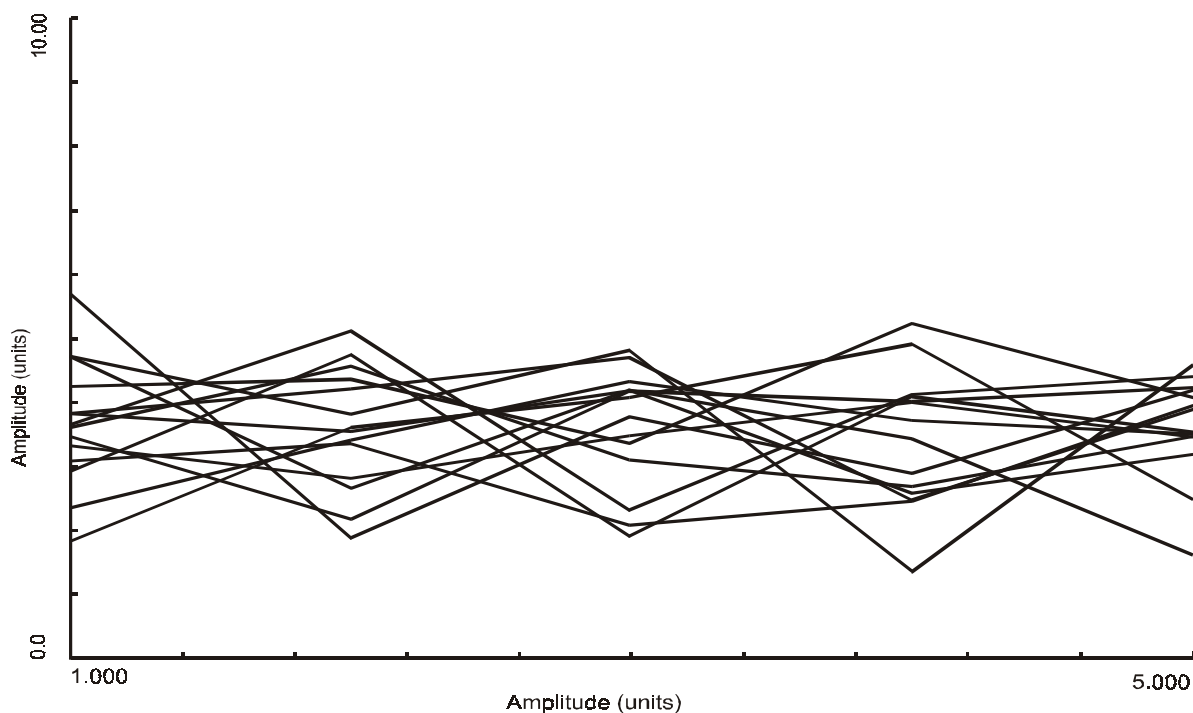

FIGURE 516.5A-1. Input test data set.

3.3 Nonparametric Upper Limits.

The envelope limit (ENV) along with the upper distribution-free tolerance limit (DFL) for β proportion of the population set at 0.95 and γ confidence coefficient of 0.51 for $N=14$ samples is displayed on figure 516.5A-2. This represents one curve with two interpretations. The 95% upper empirical tolerance limit (ETL) is also displayed on figure 516.5A-2 where at least 95% of the values will be exceeded by this limit with 50% confidence. The data is displayed on figure 516.5A-2 for comparison purposes.

MIL-STD-810F
1 January 2000
ANNEX A

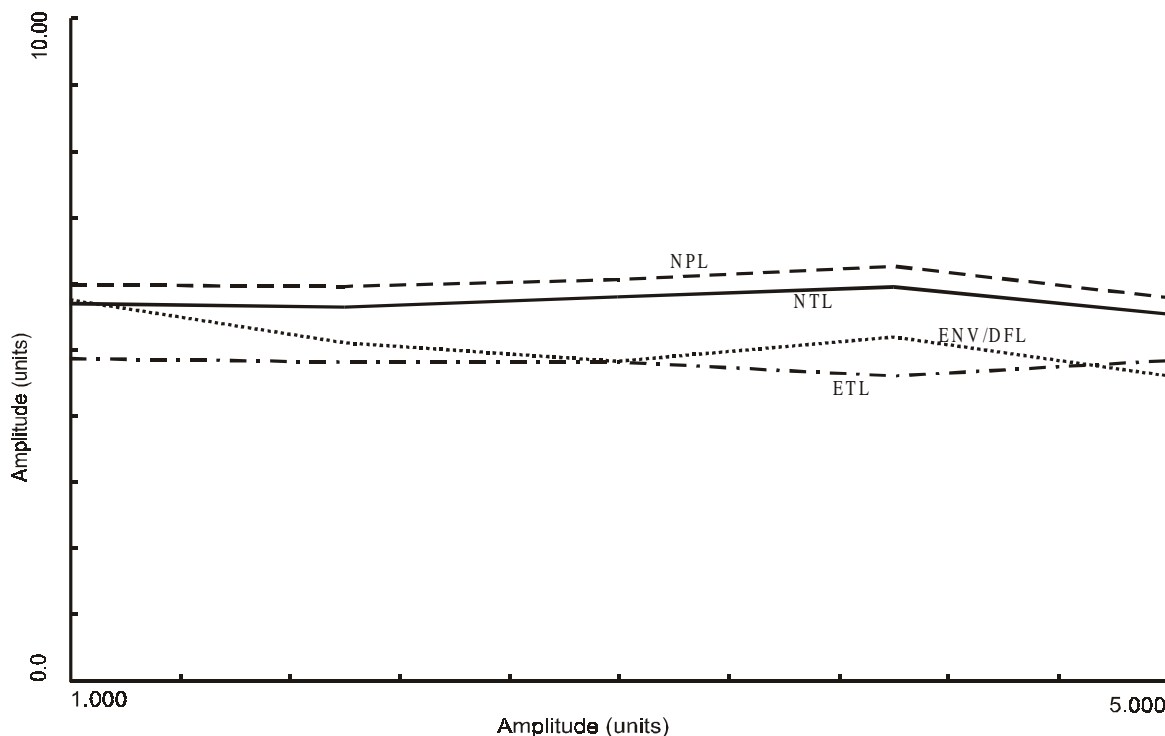

FIGURE 516.5A-2. Parametric and non-parametric upper limits.

3.4 Observations.

The “flatness” of the upper limits on figure 516.5A-2 attests to the homogeneity of the data in table 516.5A-II. It is apparent from figure 516.5A-2 that the upper limits for the parameters selected are not “statistically equivalent”. Of the two upper limit estimates the NTL is favored if it can be established that the logarithm transform of the data set is approximately normally distributed. The closeness of the nonparametric envelopes attests also to the homogeneity of the data in table 516.5A-II in addition to demonstrating, for this case at least, the nonstatistical ENV, the statistically based DFL and the ETL basically agree with regard to the upper limit magnitude. For nonhomogeneous data sets ETL would not be expected to agree with ENV or DFL. For small data sets, ETL may vary depending upon if “k” rounds upward or downward.

3.5 MATLAB m-function “ul.”

Following is a MATLAB function “ul” for computing the specified upper limit and any associated parameters. the desired upper limit is input through str_in with associated parameters in par_in. The N by M matrix of data values is input in the N by M matrix X_in. The output upper limit is in X_ul with selected parameters computed within the function in par_out. The following function has been verified with the data matrix supplied in table 516.5A-2 of this Annex. Before applying the user should clearly understand the input and verify the m-function with a simple example. The input displayed in table 516.5A-II was generated with the following MATLAB command:

$$X_in = \text{randn}(14,5) + 3.5;$$

```

function [par_out,x_ul] = ul(str_in,par_in,x_in)
% ul.m - MATLAB m-function for determining a data array upper limit
% 11-may-1999

% Input Information :
str_in - input string specifying the desired upper limit and transform
par_in - input parameters for desired upper limit
% ul.m - a M by N matrix of data values, N rows in X_in representing individual
% measurement points, M columns in X_in representing independently
% measured values. For a specified logarithm transformation of X_in, all
% the values in X_in must be positive. For STL the ratio value for a column
% of X_in must not be zero.

% STL
str_in(1:4) = 'STL'; %>> normal tolerance upper limit with log transform of X_in
str_in(5:4) = 'STL'; %>> normal tolerance upper limit of X_in
par_in = [M N 0 Beta Gamma] %>> M Beta Gamma - one sided normal
% tolerance interval table value with Beta portion and Gamma confidence

% DFL
str_in(1:4) = 'DFL'; %>> normal prediction upper limit with log transform of X_in
str_in(5:4) = 'DFL'; %>> normal prediction upper limit of X_in
par_in = [M N Gamma] %>> 0 - Gamma - 1 - alpha < 1 - confidence coefficient
par_out(1) = t_value %>> value of t(M-1,alpha)

% EPV
str_in(1:4) = 'EPV'; %>> maximum upper limit
par_in = [M N]

% OFE
str_in(1:4) = 'OFE'; %>> distribution free upper limit
par_in = [M N 0] %>> for 0 - 0 or Beta - portion of population
par_in = [M N 0] %>> for 0 - Gamma or 0 - confidence coefficient
par_out(1) = Beta - if par_in(3) = 0 and par_in(4) = Gamma
par_out(1) = Gamma - if par_in(3) = Beta and par_in(4) = 0

% ETL
str_in(1:4) = 'ETL'; %>> empirical tolerance upper limit
par_in = [M N Beta] %>> 0 - Beta < 1 where Beta - portion of population
par_out(1) = 0_Beta %>> ordered value corresponding to Beta

% Output Information :
par_out - output parameters (if any)
x_ul - a 1 by N data vector specifying the desired upper limit

M = par_in(1);
N = N - 1;
K = par_in(2);
GN = N * K;
par_out(1)=0;
x_ul=zeros(1,N);
if str_in(4) == 'L'
    x_ul = log10(X_in);
else
    x_ul = X_in;
end
% mean of N rows over N columns of X_t
n = mean(x_ul);
% standard deviation of N rows over N columns of X_t
s = std(X_t);
% zero par_out and x_ul
par_out(1) = 0;
x_ul=zeros(1,N);
% Normal Tolerance Limit
if str_in(1:3) == 'STL'
    k_M_Beta_Gamma = par_in(3);
    if str_in(4) == 'L'

```

FIGURE 516.5A-3. MATLAB m-function "ul" for upper limit determination.

MIL-STD-810F
1 January 2000
ANNEX A

TABLE 516.5A-II. Input test data set.

| | | | | |
|--------|--------|--------|--------|--------|
| 3.0674 | 3.3636 | 2.0590 | 2.4435 | 3.8803 |
| 1.8344 | 3.6139 | 4.0711 | 4.9151 | 2.4909 |
| 3.6253 | 4.5668 | 3.1001 | 2.6949 | 3.4805 |
| 3.7877 | 3.5593 | 4.1900 | 4.0287 | 3.4518 |
| 2.3535 | 3.4044 | 4.3156 | 3.7195 | 3.5000 |
| 4.6909 | 2.6677 | 4.2119 | 2.5781 | 3.1821 |
| 4.6892 | 3.7902 | 4.7902 | 1.3293 | 4.5950 |
| 3.4624 | 2.1638 | 4.1686 | 3.4408 | 1.6260 |
| 3.8273 | 4.2143 | 4.6908 | 2.4894 | 3.9282 |
| 3.6746 | 5.1236 | 2.2975 | 4.1145 | 4.3956 |
| 3.3133 | 2.8082 | 3.4802 | 4.0077 | 4.2310 |
| 4.2258 | 4.3580 | 3.3433 | 5.1924 | 4.0779 |
| 2.9117 | 4.7540 | 1.8959 | 4.0913 | 3.5403 |
| 5.6832 | 1.9063 | 3.7573 | 2.8564 | 4.1771 |

4. RECOMMENDED PROCEDURES.

4.1 Recommended Statistical Procedures for Upper Limit Estimates.

Reference g provides a detailed discussion of the advantages and disadvantages of estimate upper limits. The guidelines in this reference will be recommended here. In all cases plot the data carefully with a clear indication of the method of establishing the upper limit and the assumptions behind the method used.

- a. When N is sufficiently large, i.e., $N \geq 7$ establish the upper limit by using the expression for the DFL for a selected $\beta \geq 0.90$ such that $\gamma \geq 0.50$.
- b. When N is not sufficiently large to meet the criterion in (a), establish the upper limit by using the expression for the NTL. Select β and $\gamma \geq 0.50$. Variation in β will determine the degree of conservativeness of the upper limit.
- c. For $N > 10$ and a confidence coefficient of 0.50, the upper limit established on the basis of ETL is acceptable and may be substituted for the upper limit established by DFL or NTL. It is important when using ETL to examine and confirm the homogeneity of the estimates over the frequency bands.

4.2 Uncertainty Factors.

Uncertainty factors may be added to the resulting upper limits if confidence in the data is low or the data set is small. Factors on the order of 3 dB to 6 dB may be added. Reference g recommends a 5.8 dB uncertainty factor (based on "flight-to-flight" uncertainties of 3 dB and "point-to-point" uncertainties of 5 dB) be used with captive carry flight measured data to determine a maximum expected environment using a normal tolerance limit. It is important that all uncertainties be clearly defined and that uncertainties are not superimposed upon estimates that already account for uncertainty.

ANNEX B**EFFECTIVE SHOCK DURATION****1. SCOPE.****1.1 Purpose.**

This annex provides a basis and justification for the selection of the definition of an effective shock duration, T_e .

1.2 Application.

Information in this annex is directed towards selection of an effective shock duration for laboratory testing based upon measured data. Replication of field measured environments in the laboratory by use of synthesized complex transients on shaker control systems requires (1) satisfaction of the field measured SRS amplitude and (2) correspondence between the duration of the field measured transient and the laboratory synthesized transient. In certain cases it may be apparent that one amplitude-varying shock over a long duration may actually be two or more distinct shocks over the duration. The requirements for deciding if field measured data should be replicated in the laboratory as a single shock or as multiple shocks are (1) a clear understanding of the physical phenomenon behind the field measured environment along with an understanding of the frequency characteristics of the test item, and (2) the judgement of an experienced analyst.

2. DEVELOPMENT.**2.1 Assumptions on Shock Envelope Development.**

The shock duration is essentially determined by the form of the envelope of the absolute value of the measured peaks of the shock time history. This tacitly assumes that for a shock time history the distribution of the positive and negative peaks of the shock time history are essentially the same, i.e., the shock time history is symmetrical with respect to polarity. It should be clear that the envelope of these peaks in general is a complex piecewise continuous function that has no simple analytical description. Figure 516.5B-1a displays a typical shock time history along with its envelope and two sets of vertical lines – one indicating the duration of T_E and the other the duration of T_e . Figure 516.5B-1b displays short time average RMS along with one set of vertical lines indicating the duration of T_e . In the development to follow it is assumed that the measured shock transient peak distribution in time has an initial segment characterized by a rise time (t_r) and a following segment characterized by a decay time (t_d) where in general $t_d > t_r$. It is assumed that the envelope of the initial peak amplitude distribution normalized to the absolute value of the maximum peak acceleration, A_p , is of a third order polynomial form

$$e_r(t) = a_1 \left(\frac{t}{t_r} \right) + a_2 \left(\frac{t}{t_r} \right)^2 + a_3 \left(\frac{t}{t_r} \right)^3 \quad 0 \leq t \leq t_r \quad \text{and} \quad a_1 + a_2 + a_3 = 1$$

It is assumed that the envelope of the trailing segment is characterized by a simple exponentially decaying function normalized to A_p

$$e_j(t) = e^{-\alpha \left(\frac{t-t_r}{t_r} \right)} \quad t_r \leq t \leq t_r + t_j$$

The initial segment has three degrees of freedom for fitting whereas the trailing segment has one degree of freedom. The segments will, in general, have a much more complex form than is representable by the simple expressions $e_r(t)$ and $e_j(t)$. In general, the SRS amplitudes in the high frequency region are more sensitive to the initial segment form than the trailing segment form whereas the low frequency SRS amplitudes are sensitive to both the duration of the trailing segment and to the form of the trailing segment.

MIL-STD-810F
1 January 2000
ANNEX B

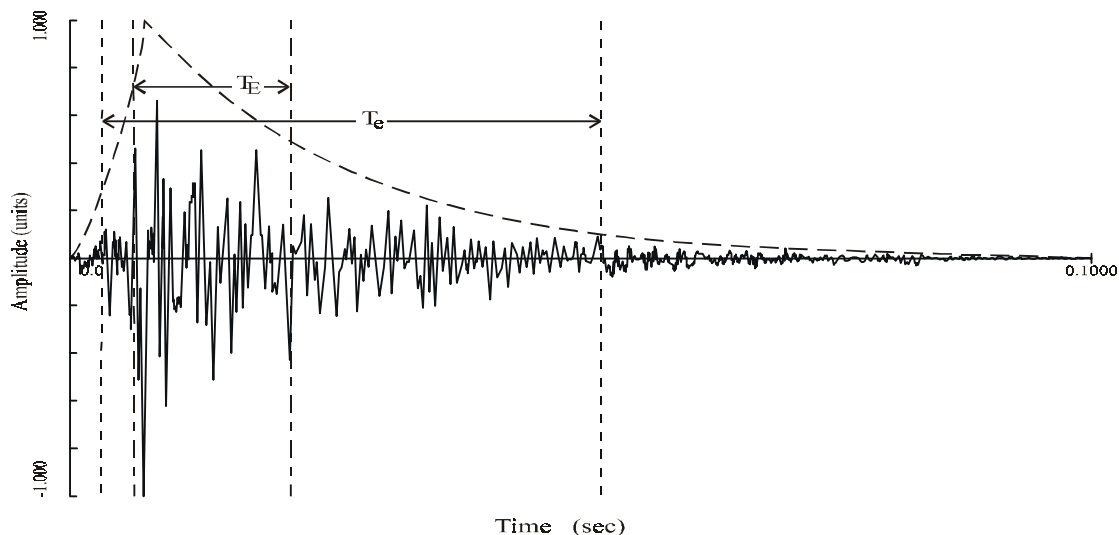

FIGURE 516.5B-1a. Typical shock time history with envelope, T_E and T_e .

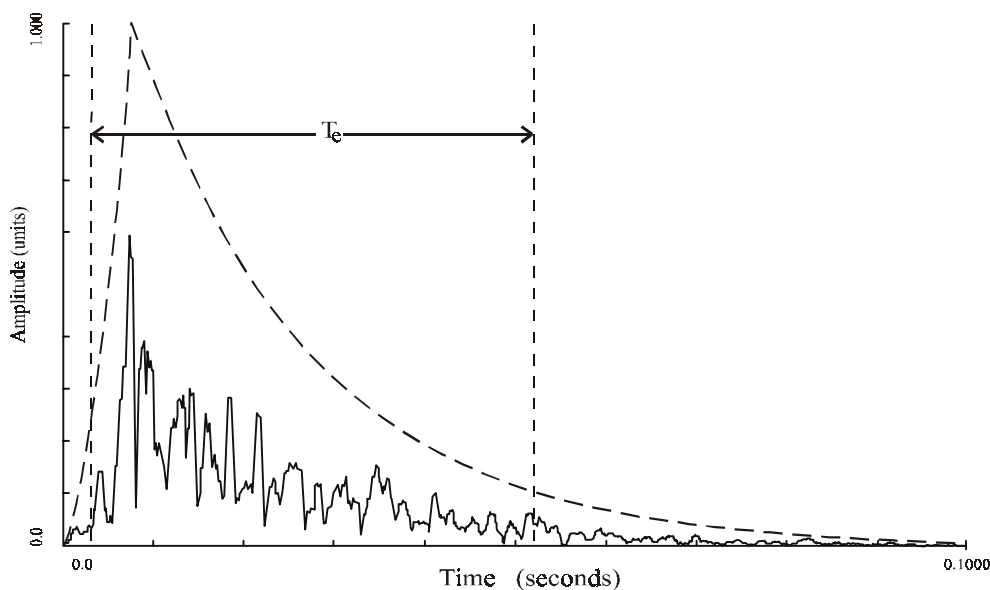

FIGURE 516.5B-1b. Typical shock time history RMS with envelope and T_e .

2.2 T_e versus T_E .

T_E was defined in MIL-STD-810E to be “the minimum length of time that contains all data magnitudes exceeding 1/3 of the peak magnitude associated with the shock event.” In this document, T_e is defined to be the minimum length of time that contains at least 90% of the root-mean-square (RMS) time history amplitudes exceeding in value 10% of the peak RMS magnitude associated with the shock event. Figure 516.5B-2 provides a scatter plot of T_E versus T_e for shocks simulated according to the envelope forms above and provides a visual correlation between the two durations. From this statistical simulation, on this particular simple form of pulse, it can be concluded that the median ratio of T_e to T_E is 2.62 with 95% of the ratios lying between 1.71 and 5.43.

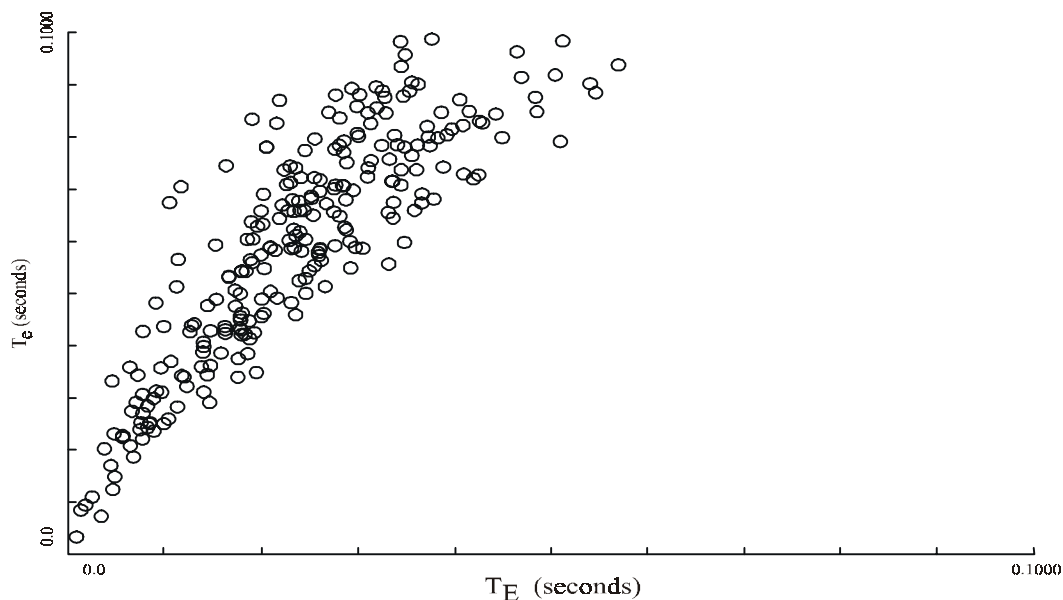

FIGURE 516.5B-2. Scatter plot T_E versus T_e

NOTE: Median Ratio $T_e/T_E = 2.62$ with 95% of Ratios between 1.71 and 5.43.

3. RECOMMENDED PROCEDURES FOR SYNTHESIS AND ANALYSIS.

3.1 Synthesis Recommended for T_e .

Table 516.5-I contains the recommended values of T_e replacing the T_E values in previous editions of MIL-STD-810. Use these values of T_e for guidance in specifying the duration of a synthesized complex transient for laboratory testing. In general T_e may be considered to be approximately $2.5 T_E$.

3.2 Synthesis Uncertainty Factors for T_e .

Table 516.5-I contains the uncertainty factors in the effective duration, T_e . Use these uncertainty factors for T_e for guidance in specifying the duration of a synthesized complex transient for laboratory testing.

3.3 Analysis Relationship to T_e .

For computation of the SRS of the shock event (for durations in which $T_e > \frac{1}{2f_{\min}}$ where f_{\min} is the minimum SRS frequency of interest), taper the beginning and the end of the shock event to zero amplitude and extend the time of the computation over the tapers and the duration T_e . Computation of the ESD or FT of the shock event must have a minimum block size of length equivalent to the duration, T_e and be zero padded to eliminate excess noise in the estimates based upon the judgement of an experienced analyst.

MIL-STD-810F
1 January 2000
ANNEX B

THIS PAGE INTENTIONALLY BLANK

ANNEX C

AUTOSPECTRAL DENSITY WITH EQUIVALENT TEST SHOCK RESPONSE SPECTRA

1. SCOPE.

1.1 Purpose.

This Annex provides information for determination if a field measured or predicted stationary random vibration ASD provides an environment that exceeds that for a field measured or predicted shock.

1.2 Application.

For field measured or predicted ASD data from high level stationary random vibration, if the data representative time history is such that it exceeds substantially the measured or predicted shock environment time history, the random vibration test may be considered to provide an adequate test for the shock environment. Perform only the stationary random vibration test.

2. DEVELOPMENT.

2.1 Assumptions on Autospectral Density.

Figure 516.5-9 provides two ASD plots for functional tests for ground materiel and flight materiel. Figures 516.5C-1a and 516.5C-1b provide the associated simulated Gaussian stationary amplitude time history segments over a 25 ms period of time for the ground materiel and the flight materiel, respectively.

2.2 Assumptions on Shock Response Spectra.

Figures 516.5C-2a and 516.5C-2b provide the associated SRS plots for 250 simulations of the time histories on figure 516.5C-1a and 516.5C-1b, respectively. In particular, the SRS plots represent the mean SRS and the upper and lower distribution free tolerance intervals based upon a 98% proportion of population with a 92% confidence coefficient and the SRS spectra specified on figure 516.5-8. The SRS were computed for a $Q=5$ over approximately one second time interval, i.e., 10 times the period of the lowest frequency represented on figure 516.5-9.

3. RECOMMENDED PROCEDURES.

3.1 Recommended for ASD.

For measured stationary random vibration data, compute the ASD and compare with the ASD of figure 516.5-9. If the measured ASD exceeds the ASD in this figure at every frequency with a maximum 5 Hz analysis filter bandwidth, perform only the random vibration test on the equipment.

3.2 Recommended for SRS.

For measured stationary random vibration data compute the ASD and compare with the ASD of figure 516.5-9. If the measured ASD does not exceed the ASD on this figure at every frequency with a maximum 5 Hz analysis filter bandwidth, sample the measured random vibration data and proceed to compute an SRS over a selected period of time no shorter than 10 times the period of the lowest frequency represented on figure 516.5-9. If the SRS exceeds the SRS of figure 516.5-8 at every frequency, consider the random vibration test adequate. If the SRS does not exceed the SRS of figure 516.5-8 at every frequency, proceed to generate a complex transient from either field measured or predicted SRS data in order to test the equipment for shock.

MIL-STD-810F
1 January 2000
ANNEX C

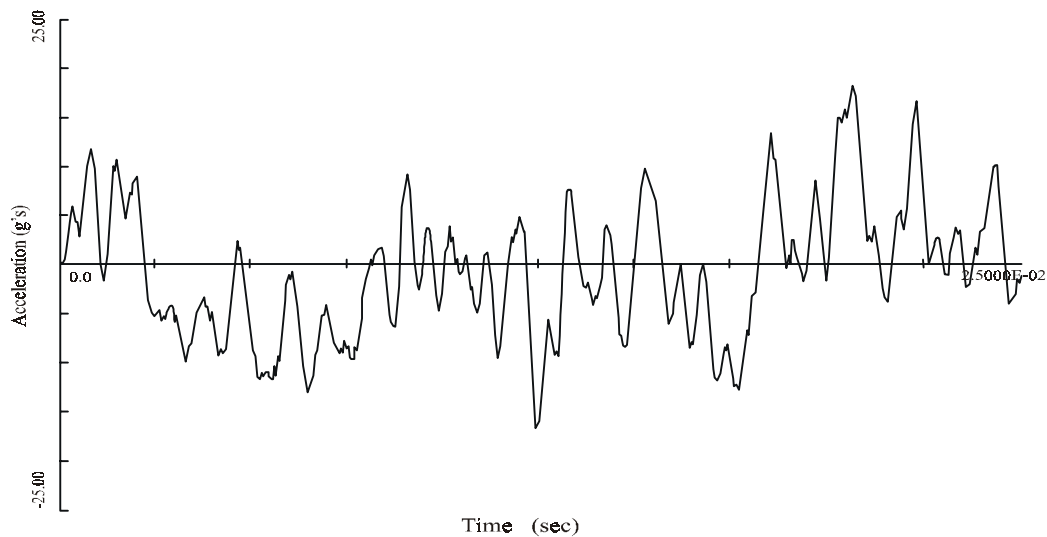

FIGURE 516.5C-1a. Sample Gaussian time history for functional test for ground materiel.

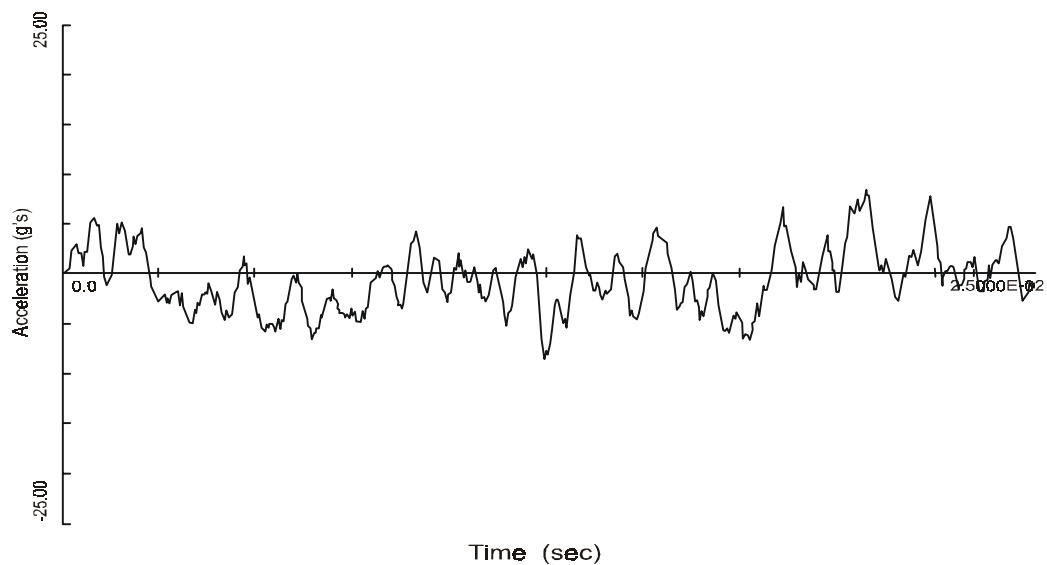

FIGURE 516.5C-1b. Sample Gaussian time history for functional test for flight materiel.

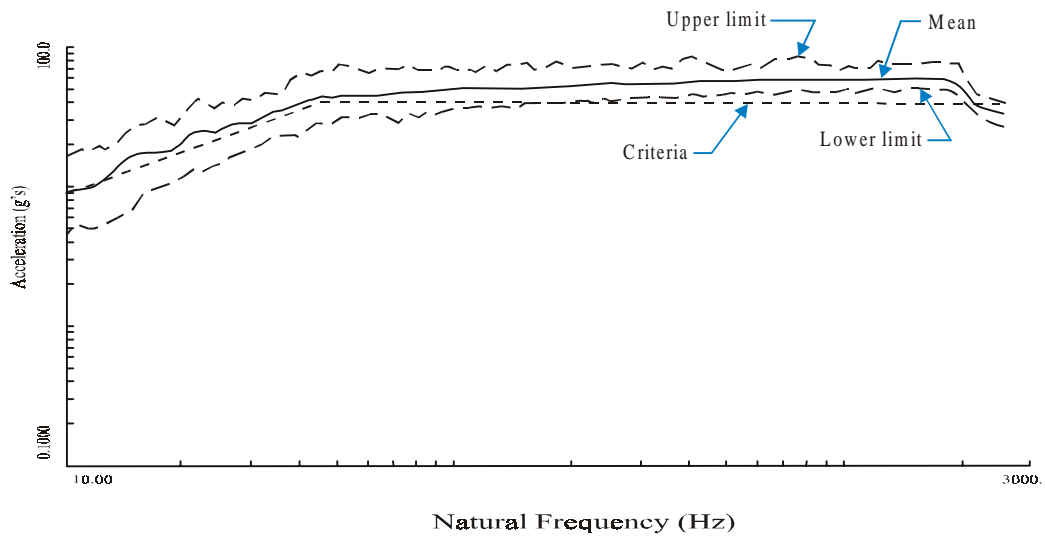

FIGURE 516.5C-2a. SRS comparison for functional test for ground materiel.

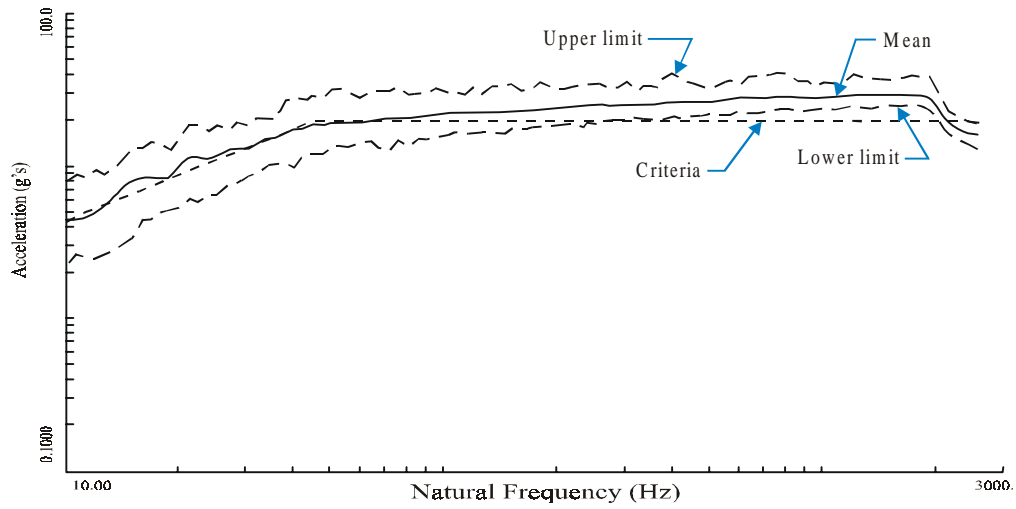

FIGURE 516.5C-2b. SRS comparison for functional test for flight materiel.

MIL-STD-810F
1 January 2000
ANNEX C

THIS PAGE INTENTIONALLY BLANK

METHOD 517

PYROSHOCK

NOTE: Tailoring is essential. Select methods, procedures, and parameter levels based on the tailoring process described in Part One, paragraph 4, and Appendix C. Apply the general guidelines for laboratory test methods described in Part One, paragraph 5 of this standard.

1. SCOPE.

1.1 Purpose.

Pyroshock tests involving pyrotechnic (explosive- or propellant-activated) devices are performed to:

- a. provide a degree of confidence that materiel can structurally and functionally withstand the infrequent shock effects caused by the detonation of a pyrotechnic device on a structural configuration to which the materiel is mounted.
- b. experimentally estimate the materiel's fragility level in relation to pyroshock in order that shock mitigation procedures may be employed to protect the materiel's structural and functional integrity.

1.2 Application.

1.2.1 Pyroshock.

Pyroshock is often referred to as pyrotechnic shock. For the purpose of this document, initiation of a pyrotechnic device will result in an effect that is referred to as a "pyroshock." "Pyroshock" refers to the localized intense mechanical transient response of materiel caused by the detonation of a pyrotechnic device on adjacent structures. A number of devices are capable of transmitting such intense transients to a materiel. In general, the sources may be described in terms of their spatial distribution - point sources, line sources and combined point and line sources (reference a). Point sources include explosive bolts, separation nuts, pin pullers and pushers, bolt and cable cutters and pyro-activated operational hardware. Line sources include flexible linear shape charges (FLSC), mild detonating fuses (MDF), and explosive transfer lines. Combined point and line sources include V-band (Marmon) clamps. The loading from the pyrotechnic device may be accompanied by the release of structural strain energy from structure preload or impact among structural elements as a result of the activation of the pyrotechnic device. Use this method to evaluate materiel likely to be exposed to one or more pyroshocks in its lifetime. Pyroshocks are generally within a frequency range between 100 Hz and 1,000,000 Hz, and a time duration from 50 microseconds to not more than 20 milliseconds. Acceleration response amplitudes to pyroshock may range from 300 g to 300,000 g. The acceleration response time history to pyroshock will, in general, be very oscillatory and have a substantial rise time, approaching 10 microseconds. In general, pyroshocks generate material stress waves that will excite materiel to respond to very high frequencies with wavelengths on the order of sizes of micro electronic chip configurations. Because of the limited velocity change in the structure brought about by firing of the pyrotechnic device, and the localized nature of the pyrotechnic device, structural resonances of materiel below 500 Hz will normally not be excited and the system will undergo very small displacements with small overall structural/mechanical damage. The pyroshock acceleration environment in the neighborhood of the materiel will usually be highly dependent upon the configuration of the materiel and the intervening structure. The materiel or its parts may be in the near-field or far-field of the pyrotechnic device with the pyroshock environment in the near-field being the most severe, and that in the far-field the least severe. There is not unanimous agreement on classifying pyroshock intensity according to the characteristics of a "near-field" and a "far-field." It has been suggested that three fields be used for intensity classification, i.e., a "mid-field" in pyroshock intensity intervening between the "near-field" and the "far-field." This document reflects the current consensus on other than spacecraft material to restrict pyroshock intensity classification to "near-field" and "far-field" for which the definitions are provided in paragraph 1.2.3. In general, some structure intervenes between the materiel and location of the pyrotechnic device.

MIL-STD-810F
1 January 2000

1.2.2 Pyroshock - momentum exchange.

Pyroshock usually exhibits no momentum exchange between two bodies (a possible exception is the transfer of strain energy from stress wave propagation from a device through structure to the materiel). Pyroshock results in essentially no velocity change in the materiel support structure. Frequencies below 100 Hz are never of concern. The magnitude of a pyroshock response at a given point reasonably far from the pyrotechnic source is, among other things, a function of the size of the pyrotechnic charge. Pyroshock is a result of linear elastic material waves propagating in the support structure to the materiel without plastic deformation of large portions of the structure except at the charge point or line. In general, joints and bolted connections representing structure discontinuities tend to greatly attenuate the pyroshock amplitudes. With regard to measurement technology, accelerometers, strain gages and laser velocimeters are commonly used devices for measurement. In processing pyroshock data, it is important to be able to detect anomalies. A part of this detection is the integration of the acceleration amplitude time history to determine if it has the characteristics of a high frequency velocity trace. Pyroshock is “designed” into the materiel by placement of pyroshock devices for specific utility. Because to a great extent the pyroshock environment is clearly defined by the geometrical configuration and the charge or the activating device, pyroshock response of materiel in the field may be moderately predictable and repeatable for materiel (reference a.).

1.2.3 Pyroshock - physical phenomenon.

Pyroshock is a physical phenomenon characterized by the overall material and mechanical response at a structure point from either (a) an explosive device, or (b) a propellant activated device. Such a device may produce extreme local pressure (with perhaps heat and electromagnetic emission) at a point or along a line. The device provides a near instantaneous generation of local, high-magnitude, nonlinear material strain rates with subsequent transmission of high-magnitude/high frequency material stress waves producing high acceleration/low velocity and short duration response at distances from the point or line source. The characteristics of pyroshock are:

- a. near-the-source stress waves in the structure caused by high material strain rates (nonlinear material region) propagate into the near-field and beyond;
- b. high frequency (100 Hz-1,000,000 Hz) and very broadband frequency input;
- c. high acceleration (300 g-300,000 g) but low structural velocity and displacement response;
- d. short-time duration (<20 msec);
- e. high residual structure acceleration response (after the event);
- f. caused by (1) an explosive device or (2) a propellant activated device (releasing stored strain energy) coupled directly into the structure; (for clarification, a propellant activated device includes items such as a clamp that releases strain energy causing a structure response greater than that obtained from the propellant detonation alone);
- g. highly localized point source input or line source input;
- h. very high structural driving point impedance (P/v , where P is the detonation large force or pressure, and v , the structural velocity, is very small). At the source, the material driving point impedance can be substantially less for high material particle velocity;
- i. response time histories that are random in nature, providing little repeatability and substantial dependency on the materiel configuration details;
- j. response at points on the structure that are greatly affected by structural discontinuities;
- k. materiel and structural response that may be accompanied by substantial heat and electromagnetic emission (from ionization of gases during explosion);
- l. the nature of the response to pyroshock that suggests the materiel or its components may be classified as being in the near-field or far-field of the pyrotechnic device. The terms “near-field” and “far-field” relate to the shock intensity at the response point and such intensity is a function of the distance from the source and the structural configuration between the source and the response point.

- (1) Near-field. In the near-field of the pyrotechnic device, the structure material stress wave propagation effects govern the response. In the near-field of an intense pyrotechnic device, the materiel or any portion of the materiel is within 15 cm (6 in) of the point of detonation of the device or a portion of it (in the case of a line charge). If there are no intervening structural discontinuities, the materiel may be expected to experience peak accelerations in excess of 5000 g's and substantial spectral content above 100,000 Hz. The near-field of a less intense pyrotechnic device can be considered to be within 7.5 cm (3 in) with a subsequent reduction in the peak acceleration levels and spectral levels.
- (2) Far-field. In the far-field of the pyrotechnic device, the pyroshock response is governed by a combination of material stress wave propagation and structural resonance response effects. For an intense pyrotechnic device, the materiel or any portion of the materiel is beyond 15 cm (6 in) from the device. If there are no intervening structural discontinuities, the materiel may be expected to experience peak accelerations between 1000 g's and 5000 g's, and substantial spectral content above 10,000 Hz. The far-field of a less intense pyrotechnic device can be considered to be beyond 7.5 cm (3 in) with a subsequent reduction in the peak acceleration levels and spectral levels.

1.3 Limitations.

Because of the highly specialized nature of pyroshock, apply it only after giving careful consideration to information contained in references a, b, c, and d.

- a. This method does not include the shock effects experienced by materiel as a result of any mechanical shock/transient vibration, shipboard shock, or EMI shock. For these types of shocks, see the appropriate methods in this or other standards.
- b. This method does not include the effects experienced by fuze systems that are sensitive to shock from pyrotechnic devices. Shock tests for safety and operation of fuzes and fuse components may be performed in accordance with MIL-STD-331.
- c. This method does not include special provisions for performing pyroshock tests at high or low temperatures. Perform tests at room ambient temperature unless otherwise specified or if there is reason to believe either operational high temperature or low temperature may enhance the pyroshock environment.
- d. This method does not include guidance related to unplanned test interruption as a result of pyroshock device or mechanical test equipment malfunction in cases in which the pyroshock is being mechanically simulated. Generally, if the pyroshock device malfunctions or interruption occurs during a mechanical shock pulse, repeat that shock pulse. Care must be taken to ensure stresses induced by the interrupted shock pulse do not invalidate subsequent test results. Inspect the overall integrity of the materiel to ensure pre-shock test materiel structural and functional integrity. Record and analyze data from such interruptions before continuing with the test sequence.
- e. This method is not intended to be applied to manned space vehicle testing (see reference a).
- f. This method does not address secondary effects such as induced blast, EMI, and thermal effects.
- g. This method does not apply to effects of hostile weapon penetration or detonation.

2. TAILORING GUIDANCE.

2.1 Selecting the Pyroshock Method.

After examining requirements documents and applying the tailoring process in Part One of this standard to determine where pyroshock effects are foreseen in the life cycle of the materiel, use the following to confirm the need for this method and to place it in sequence with other methods.

MIL-STD-810F
1 January 2000

2.1.1 Effects of pyroshock.

In general, pyroshock has the potential for producing adverse effects on all electronic materiel. The level of adverse effects generally increases with the level and duration of the pyroshock, and decreases with the distance from the source (pyrotechnic device) of the pyroshock. Durations for pyroshock that produce material stress waves with wavelengths that correspond with the natural frequency wavelengths of micro electronic components within materiel will enhance adverse effects. In general, the structural configuration merely transmits the elastic waves and is unaffected by the pyroshock. Examples of problems associated with pyroshock follow, but the list is not intended to be all-inclusive.

- a. materiel failure as a result of destruction of the structural integrity of micro electronic chips;
- b. materiel failure as a result of relay chatter;
- c. materiel failure as a result of circuit card malfunction, circuit card damage, and electronic connector failure. On occasion, circuit card contaminants having the potential to cause short circuits may be dislodged under pyroshock.
- d. materiel failure as a result of cracks and fracture in crystals, ceramics, epoxies, or glass envelopes.

2.1.2 Sequence among other methods.

- a. General. See Part One, paragraph 5.5.
- b. Unique to this method. Unless otherwise displayed in the life cycle profile and, since pyroshock is normally experienced near the end of the life cycle, schedule pyroshock tests late in the test sequence. In general, the pyroshock tests can be considered independent of the other tests because of their unique nature.

2.2 Selecting a Procedure.

This method includes four pyroshock test procedures:

- a. Procedure I - Near-field with an actual configuration. Replication of pyroshock for the near-field environment using the actual materiel and the associated pyrotechnic shock test device configuration.
- b. Procedure II - Near-field with a simulated configuration. Replication of pyroshock for the near-field environment using the actual materiel but with the associated pyrotechnic shock test device isolated from the test item, e.g., by being mounted on the back of a flat steel plate. (This normally will minimize testing costs because fewer materiel configurations and/or platforms associated with the test item will be damaged. This can be used for repeated tests at varying pyroshock levels.)
- c. Procedure III - Far-field with a mechanical test device. Replication of pyroshock for the far-field environment with a mechanical device that simulates the pyroshock peak acceleration amplitudes and frequency content (other than an electrodynamic shaker because of frequency range limitations of the electrodynamic shaker).
- d. Procedure IV - Far-field with an electrodynamic shaker. Replication of pyroshock for the far-field environment using an electrodynamic shaker to simulate the comparatively low frequency structural resonant response to the pyroshock.

2.2.1 Procedure selection considerations.

Based on the test data requirements, determine which test procedure is applicable. In most cases, the selection of the procedure will be dictated by the actual materiel configuration, carefully noting any structural discontinuities that may serve to mitigate the effects of the pyroshock on the materiel. In some cases, the selection of the procedure will be driven by test practicality. Consider all pyroshock environments anticipated for the materiel during its life cycle, both in its logistic and operational modes. When selecting procedures, consider:

- a. The operational purpose of the materiel. From the requirements documents, determine the functions to be performed by the materiel either during or after exposure to the pyroshock environment.

- b. The natural exposure circumstances for pyroshock. Determine if the materiel or portion of the materiel lies within the near-field or far-field of the pyrotechnic device. If the materiel or a portion of the materiel lies within the near-field of the pyrotechnic device, no special isolation of the materiel exists and, if there are no prior measured field data, apply only Procedure I or II. If no portion of the materiel lies within the near-field of the pyrotechnic device and measured field data exist, apply Procedure III if the processed field data supports the amplitude and frequency range capabilities of the test devices. If the entire materiel lies within the far-field and is subject to structural response, only apply Procedure IV if the processed data supports the comparatively low frequency range (to 3000 Hz) of an electrodynamic shaker. If the entire materiel lies within the far-field and the processed data does not support the electrodynamic shaker comparatively low frequency range, apply Procedure III. In any case, one test will be considered sufficient for testing over the entire amplitude and frequency range of exposure of the materiel. Do not break up any measured or predicted response to pyroshock into separate frequency ranges for the purpose of applying different testing procedures to different frequency ranges.
- c. Required data. The test data required to verify that the materiel will survive and function as intended.
- d. Procedure sequence. Refer to paragraph 2.1.2.

2.2.2 Difference among procedures.

- a. Procedure I - Near-field with Actual Configuration. Procedure I is intended to test materiel (including mechanical, electrical, hydraulic, and electronic) in its functional mode and actual configuration (materiel/pyrotechnic device physical configuration), and to ensure it can survive and function as required when tested using the actual pyrotechnic test device in its intended installed configuration. In Procedure I, it is assumed that the materiel or a portion of the materiel resides within the near-field of the pyrotechnic device.
- b. Procedure II - Near-field with Simulated Configuration. Procedure II is intended to test materiel (including mechanical, electrical, hydraulic, and electronic) in its functional mode but with a simulated structural configuration, and to ensure it can survive and function as required when in its actual materiel/pyrotechnic device physical configuration. In this procedure it is assumed that some part of the materiel lies within the near-field of an intense or less intense pyrotechnic device. Make every attempt to use this procedure to duplicate the actual platform/materiel structural configuration by way of a full-scale test. If this is too costly or impractical, employ scaled tests provided that in the process of scaling, important configuration details are not omitted. In particular, only the structure portion directly influencing the materiel may be involved in the test, provided it can be reasonably assumed that the remainder of the structure will not influence materiel response. On occasion, for convenience, a special pyrotechnic testing device may be employed for testing the materiel, e.g., a flat steel plate to which the materiel is mounted and the pyrotechnic charge is attached.
- c. Procedure III - Far-field Using a Mechanical Test Device. Pyroshock can be applied utilizing conventional high acceleration amplitude/frequency test input devices. Reference c provides a source of alternative test input devices, their advantages, and limitations. In this procedure, it is assumed that all parts of the materiel lie in the far-field of the pyrotechnic device. Consult reference c for guidelines and considerations for such testing.
- d. Procedure IV - Far-field Using an Electrodynamic Shaker. On occasion, pyroshock response can be replicated utilizing conventional electrodynamic shakers. In this procedure, it is assumed that all parts of the materiel lie in the far-field of the pyrotechnic device, and the materiel is subject to the structure platform resonant response alone.

2.3 Determine Test Levels and Conditions.

Having selected one of the four pyroshock procedures (based on the materiel's requirements documents and the tailoring process), complete the tailoring process by identifying appropriate parameter levels, applicable test conditions and applicable test techniques for that procedure. Exercise extreme care in consideration of the details in the tailoring process. Base these selections on the requirements documents, the Life Cycle Environmental Profile,

MIL-STD-810F
1 January 2000

the Operational Environment Documentation (see Part One, figure 1-1), and information provided with this procedure. Consider the following basic information when selecting test levels.

2.3.1 General considerations - terminology.

- a. In general, response acceleration will be the experimental variable of measurement for pyroshock. However, this does not preclude other variables of measurement such as velocity, displacement, or strain from being measured and processed in an analogous manner, as long as the interpretation, capabilities, and limitations of the measurement variable and measurement system are well-defined. Pay particular attention to the high frequency environment generated by the pyrotechnic device and the capabilities of the measurement system to faithfully record the materiel's responses. References a and b detail the tradeoffs among pyroshock measurement techniques. In any case, implement the guidelines in reference b. For the purpose of this method, the terms that follow will be helpful in the discussion relative to analysis of response measurements from pyroshock testing. To facilitate the definition of the terms, each of the terms is illustrated for a typical pyroshock measurement. Figure 517-1 provides an acceleration time history plot of a measured far-field pyroshock with the instrumentation noise floor displayed before the pyroshock, the pyroshock, and the subsequent post-pyroshock noise floor. It is important to provide measurement data including both the pre-pyroshock noise measurement and the post-pyroshock combined noise and low level residual structure response. The vertical lines at three discrete times are used to identify a "short duration" truncated pyroshock response and a "long duration" pyroshock response. The pre-pyroshock time interval, before the first vertical line, contains the instrumentation system noise floor and serves as a measurement signal reference level. The pyroshock time interval includes all the significant response energy of the event. The post-pyroshock time interval, after the third vertical line, is of equal duration to the pre-pyroshock time interval and contains the measurement system noise in addition to some of the pyroshock residual noise considered inconsequential to the response energy in the pyroshock. In cases in which the pre-pyroshock and the post-pyroshock amplitude levels are substantial compared to the pyroshock (the pyroshock has been mitigated and/or the measurement system noise is high), the identification of the pyroshock may be difficult and engineering judgment must be used relative to determining the start and the termination of the pyroshock event. In any case, analysis of pre-pyroshock and post-pyroshock measurement information in conjunction with the pyroshock measurement information is essential. Validate all data collected from a pyroshock. Reference b provides guidelines for this. Perhaps one of the simplest and most sensitive criteria for validation is an integration of the signal time history after removing any small residual offset. If the resulting integrated signal has zero crossings and does not appear to monotonically increase, the pyroshock has passed this validation test. Figure 517-2 provides the velocity plot for the long duration pyroshock on figure 517-1.
- (1) Effective transient duration: The "effective transient duration," T_e , is the minimum length of time which contains all significant amplitude time history magnitudes beginning at the noise floor of the instrumentation system just prior to the initial most significant measurement, and proceeding to the point that the amplitude time history is a combination of measurement noise and substantially decayed structural response. In general, an experienced analyst is required to determine the pertinent measurement information to define the pyroshock event. The longer the duration of the pyroshock, the more low frequency information is preserved which may be important in far-field test considerations for the pyroshock. For near-field test considerations, in general, the effective transient duration will be much shorter because of the higher ranging of the measurement system. The amplitude criterion requires that the amplitude of the post-pyroshock amplitude time history envelope be no more than 12 dB above the noise floor of the measurement system depicted in the pre-pyroshock amplitude time history. From figure 517-1 there appear to be at least two logical time intervals for the duration of the pyroshock. The first duration is immediately after the end of the high frequency information - the second vertical line on figure 517-1 at approximately 3.5 milliseconds after the beginning of the pyroshock. The second duration is given by the third vertical line on figure 517-1, some 6.6 milliseconds after the beginning of the pyroshock and after some of the apparent low frequency structural response has been attenuated - the third vertical line on figure 517-1. These judgments based on examination of the amplitude time history utilized an amplitude criterion and a low frequency criterion. Figure 517-3 contains a plot of amplitude of the absolute

value of the pyroshock in dB versus time. This figure illustrates the difficulty in coming up with precise criteria for determining the effective duration of a pyroshock. The initial noise floor level is never obtained after the long duration pyroshock. Figure 517-4 illustrates the difference between SRS processing of two different pyroshock durations on figure 517-1, with the SRS, i.e., the short duration pyroshock (3.5 ms), and the long duration pyroshock (6.6 ms). It is clear that the only significant difference is near 100 Hz. The magnitude of the SRS at selected natural frequencies (particularly high frequencies) can be quite insensitive to the effective transient duration.

- (2) Shock Response Spectrum analysis: Reference e defines the absolute acceleration maximax Shock Response Spectrum (SRS) and provides examples of SRS computed for classical pulses. The SRS value at a given undamped oscillator natural frequency, f_n , is defined to be the absolute value of the maximum of the positive and negative acceleration responses of a mass for a given base input to a damped single degree of freedom system. The base input is the measured shock over a specified duration (the specified duration should be the effective transient duration, T_e). For processing of pyroshock response data, the absolute acceleration maximax SRS has become the primary analysis descriptor. In this measurement description of the pyroshock, the maximax absolute acceleration values are plotted on the ordinate with the undamped natural frequency of the single degree of freedom system with base input plotted along the abscissa. A more complete description of the pyroshock (and potentially more useful for pyroshock damage comparison in the far-field) can be obtained by determining the maximax pseudo-velocity response spectrum and plotting this on four-coordinate paper where, in pairs of orthogonal axes, (1) the maximax pseudo-velocity response spectrum is represented by the ordinate with the undamped natural frequency being the abscissa, and (2) the maximax absolute acceleration along with the maximax pseudo-displacement plotted in a pair of orthogonal axes (reference e). The maximax pseudo-velocity at a particular oscillator undamped natural frequency is thought to be more representative of the damage potential for a shock since it correlates with stress and strain in the elements of a single degree of freedom system (references f, g, and h). The maximax pseudo-velocity response spectrum can be computed either by (1) dividing the maximax absolute acceleration response spectrum by the undamped natural frequency of the single degree of freedom system, or (2) multiplying the maximax relative displacement by the undamped natural frequency of the single degree of freedom system. Both means of computation provide essentially the same spectra except possibly in the lower frequency region, in which case the second method of computation is more basic to the definition of the maximax pseudo-velocity response spectrum. Figure 517-5 provides the estimate of the maximax absolute acceleration SRS for the pyroshock record on figure 517-1. Figure 517-6 provides the estimate of the maximax pseudo-velocity for this record on four-coordinate paper. Note that information below 100 Hz is not considered valid for processing in these measurements. In general, compute the SRS over the pyroshock event duration and over the same duration for the pre-pyroshock and the post-pyroshock events with twelfth octave spacing and a $Q = 10$ ($Q=10$ corresponds to a single degree of freedom system with 5% critical damping). If the testing is to be used for laboratory simulation, use a second Q value of 50 ($Q=50$ corresponds to a single degree of freedom system with 1% critical damping) in the processing. It is recommended that the maximax absolute acceleration SRS be the primary method of display for the pyroshock, with the maximax pseudo-velocity SRS as the secondary method of display and useful in cases in which it is desirable to correlate damage of simple systems with the pyroshock.
- (3) Energy Spectral Density: Reference a mentions the Energy Spectral Density (ESD) estimate for a pyroshock of duration T_e . In this description, the properly scaled magnitude of the Fourier Transform of the total pyroshock is computed at a uniformly spaced set of frequencies and displayed as a two-dimensional plot of amplitude versus frequency. The amplitude units are (units²-sec/Hz). In determining the ESD estimate, it is important that the Fast Fourier Transform block size is picked such that all of the pyroshock event is contained within the block but excessive noise beyond the duration of the pyroshock be removed by zero-padding within the block. The ESD description is useful for comparing the distribution of energy within the frequency band among several pyroshocks. However, if adjacent frequency components are not averaged, the percentage of normalized random error in the ordinate is 100%. By averaging n adjacent ordinates, the percentage

MIL-STD-810F
1 January 2000

of normalized random error decreases as $1/\sqrt{n}$ with a decreased frequency resolution. Computation of the ESD estimates for the pre-pyroshock and the post-pyroshock provide useful information relative to the distinct frequency character of the pyroshock as compared to the frequency character of the pre-pyroshock noise and the post-pyroshock combination noise and structural response. Figure 517-7 provides ESD estimates for the pyroshock and the pre-pyroshock and post-pyroshock events on figure 517-1.

- (4) **Fourier Spectra:** Reference a mentions the Fourier Spectra (FS) estimate for a pyroshock of duration T_e . In this description, the properly scaled square root of the magnitude of the Fourier Transform of the total pyroshock is computed at a uniformly spaced set of frequencies and displayed as a two-dimensional plot of amplitude versus frequency. The amplitude units are (units-sec). In determining the FS estimate, it is important that the Fast Fourier Transform block size is picked such that all of the transient is contained within the block, but excessive noise beyond the duration of the transient be removed by zero-padding the block. For the FS estimate, this description is useful for noting outstanding frequency components within the overall frequency band amongst pyroshocks. If adjacent frequency components are not averaged, the percentage normalized random error in the ordinate is 100%. By averaging n adjacent ordinates, the percentage of normalized random error decreases as $1/\sqrt{n}$ with a decreased frequency resolution. Computation of the FS estimates for the pre-pyroshock and the post-pyroshock provide useful information relative to the distinct frequency character of the pyroshock as compared to the frequency character of the pre-pyroshock noise and the post-pyroshock combination noise and structural response. Figure 517-8 provides FS estimates for the pyroshock and the pre-pyroshock and post-pyroshock events on figure 517-1. These plots correspond to the ESD plots on figure 517-7.
 - (5) **Other methods:** Over the past few years, at least two other techniques potentially useful in processing pyroshock data have been suggested. Reference i describes the utilization of time domain or temporal moments for comparing the characteristics of the pyroshock over different frequency bands. The usefulness of this technique resides in the fact that if the pyroshock can be represented by a simple nonstationary product model, the time domain moments must be constant over selected filter bandwidths. Thus, the pyroshock can be characterized by a model with potential usefulness for stochastic simulation. Reference j explores this reasoning for mechanical shock. Reference k describes the use of wavelets for vibration. It has been suggested that wavelet processing may be useful for pyroshock description, particularly if a pyroshock contains information at intervals of time over the duration of the shock at different time scales, i.e., different frequencies. It is likely that this form of processing may become more prevalent in the future as the level of examination of transients becomes more sophisticated and if wavelet processing is shown to be more useful for description of phenomenon with substantial randomness.
- b. In general, for pyroshock tests, a single response record is obtained. At times, it may be convenient or even necessary to combine equivalent processed responses in some appropriate statistical manner. Reference l and method 516.5, Annex 516.5A of this standard discuss some options in statistically summarizing processed results from a series of tests. In general, processed results, either from the SRS, ESD, or FS are logarithmically transformed in order to provide estimates that are more normally distributed. This is important since often very little data are available from a test series, and the probability distribution of the untransformed estimates cannot be assumed to be normally distributed. In general, the combination of processed results will fall under the category of small sample statistics and needs to be considered with care. Parametric or less powerful nonparametric methods of statistical analysis may usually be effectively applied.

2.3.2 Test conditions - shock spectrum transient duration and scaling.

Derive the SRS and the effective transient duration, T_e , from measurements of the materiel's environment or, if available, from dynamically scaled measurements of a similar environment. Because of the inherent high degree of measurement randomness and limited response prediction methodology associated with the response to a pyroshock,

extreme care must be exercised in dynamically scaling a similar event. For pyroshocks, there are two known scaling laws for use with response from pyroshocks that may be helpful if used with care (reference a).

2.3.2.1 Pyroshock source energy scaling (SES).

The first scaling law is the Source Energy Scaling (SES) where the SRS is scaled at all frequencies by the ratio of the total energy release of two different devices. For E_r and E_n , the total energy in two pyrotechnic shock devices, the relationship between the SRS processed levels at a given natural frequency f_n and distance D_1 is given by the following expression:

$$\text{SRS}(f_n | E_n, D_1) = \text{SRS}(f_n | E_r, D_1) \left(\sqrt{\frac{E_n}{E_r}} \right)$$

In utilizing this relationship, it is assumed that either an increase or decrease in the total energy of the pyrotechnic shock devices will be coupled into the structure in exactly the same way, i.e., excessive energy from a device will go into the structure as opposed to being dissipated in some other way, e.g., through the air. E_n and E_r may come from physical considerations related to the pyrotechnic device or be computed from ESD estimates (or in the time domain by way of a Parseval form relationship) where it is assumed that the time history measurements quantify the energy difference. Reference a discusses conditions under which this scaling law may lead to over-prediction for $E_n > E_r$ or under-prediction when $E_n < E_r$.

2.3.2.2 Pyroshock response location distance scaling (RLDS).

The second scaling law is the Response Location Distance Scaling (RLDS) where the SRS is scaled at all frequencies by an empirically derived function of the distance between two sources. For D_1 and D_2 , the distances from a pyrotechnic shock device (point source), the relationship between the SRS processed levels at a given natural frequency, f_n , is given by the following expression :

$$\text{SRS}(D_2) = \text{SRS}(D_1) \exp \left\{ \left[-8 \times 10^{-4} f_n^{(2.4f_n - 0.105)} \right] (D_2 - D_1) \right\}$$

In utilizing this relationship it is assumed that D_1 and D_2 can be easily defined as in the case of a pyrotechnic point source device. Figure 517.5-9 from reference a displays the ratio of $\text{SRS}(f_n|D_2)$ to $\text{SRS}(f_n|D_1)$ as a function of the natural frequency, f_n , for selected values of $D_2 - D_1$. It is clear from this plot that, as the single degree of freedom natural frequency increases, there is a marked decrease in the ratio for a fixed $D_2 - D_1 > 0$ and as $D_2 - D_1$ increases the attenuation becomes substantial. This scaling relationship when used for prediction between two configurations, relies very heavily upon (1) similarity of configuration and (2) the same type of pyrotechnic device. Consult reference a before applying this scaling relationship.

2.3.2.3 Measured data available from pyroshock.

- a. If measured data are available, the data may be processed utilizing the SRS, FS, or ESD. For engineering and historical purposes, the SRS has become the standard for measured data processing. In the discussion to follow, it will be assumed that the SRS is the processing tool. In general, the maximum SRS spectrum (absolute acceleration or absolute pseudo-velocity) is the main quantity of interest. With this background, determine the shock response spectrum required for the test from analysis of the measured environmental acceleration time history. After carefully qualifying the data, to make certain there are no anomalies in the amplitude time history, according to the recommendations provided in reference b, compute the SRS. The analysis will be performed for $Q = 10$ at a sequence of natural frequencies at intervals of at least 1/6 octave and no finer than 1/12th octave spacing to span at least 100 to 20,000 Hz, but not to exceed 100,000 Hz. When a sufficient number of representative shock spectra are available, employ an appropriate statistical technique (an enveloping technique) to determine the required test spectrum. Annex 516.5A of method 516.5 references the appropriate statistical techniques. Parametric statistics can be employed if the data can be shown to satisfactorily fit an assumed underlying probability distribution. When a normal or lognormal distribution can be justified, Annex 516.5A and reference l provide a method for estimating such a test level. Test levels based upon a maximum

MIL-STD-810F
1 January 2000

predicted environment defined to be equal to or greater than the 95th percentile value at least 50 percent of the time utilizes a one-sided tolerance interval approach.

- b. When insufficient data are available for statistical analysis, use an increase over the maximum of the available spectral data to establish the required test spectrum to account for randomness and inherent variability of the environment. The degree of increase is based upon engineering judgment and is supported by rationale for that judgment. In these cases, it is often convenient to envelope the SRS by computing the maximax spectra over the sample spectra and proceed to add a +6dB margin to the SRS maximax envelope over the entire frequency range of interest.
- c. When employing the pyroshock method, determine the effective transient duration, T_e , from the measurement time histories of the environmental data as suggested in paragraph 2.3.1. For all procedures, the pyroshock amplitude time history used for the SRS analysis will be T_e in duration. In addition, measurement data will be collected for a duration, T_e , just prior to the pyroshock, and duration, T_e , just after the pyroshock for subsequent analysis. In general, each individual axis of the three orthogonal axes will have approximately the same shock test SRS and average effective duration as a result of the omni-directional properties of a pyroshock in Procedure I and Procedure II. For Procedures III and IV, the form of shock test SRS may vary with axes. Use an SRS shaker shock replication method when using Procedure IV; do not use classical shock pulse forms, e.g., half-sine, terminal-peak saw tooth, etc., in the testing.

2.3.2.4 Measured data not available from pyroshock.

If a database is not available for a particular configuration, use configuration similarity and any associated measured data for prescribing a pyroshock. Because of the sensitivity of the pyroshock to the system configuration and the wide randomness and variability inherent in pyrotechnic measurements, the tester must proceed with caution. As a basic guide for pyroshock testing, figure 517-10 from reference p provides SRS estimates for four typical aerospace application pyrotechnic point source devices. Figure 517-11 from reference a provides information on the attenuation of the peaks in the SRS, and of the ramp in the SRS of the point sources on figure 517-10 with distance from the source. Information on figure 517-10 and figure 517-11 come from reference m. Reference m also recommends that the attenuation of the peak SRS across joints be taken to be 40% per joint for up to three joints, and that there be no attenuation of the ramp portion (portion linearly increasing with frequency on the log log plot) of the SRS. Figure 517-12 provides the degree of attenuation of the peak amplitude time history response as a function of the shock path distance from the source for seven aerospace structural configurations. This information was summarized from reference n. The SES scaling law or the RLDS scaling law may provide guidance. In most cases, either Procedure II or Procedure III are the optimum procedures for testing, with the smallest risk of either substantial undertest or gross overtest, when Procedure I is not an option. Proceed with caution with Procedure II or Procedure III, cognizant of the information contained in reference c. Generally, a test transient is deemed suitable if its SRS equals or exceeds the given SRS requirement over the minimum frequency range of 100 to 20,000 Hz and the effective transient duration (T) of the test transient is within 20% of that of the normal pyroshock response transient duration (T_e). (See paragraph 4.2.2 for test tolerances.)

2.3.3 Test axes, duration, and number of shock events.

2.3.3.1 General.

A suitable test shock for each axis is one that yields an SRS that equals or exceeds the required test SRS over the specified frequency range when using a specified duration for the test shock time history, and when the effective transient duration of the shock (T_e) is within twenty percent of the specified T_e value. For Procedure I, T_e is not specified, but is measured. Properly validate the test data and determine the maximax acceleration SRS for $Q = 10$, and at least at 1/12-octave frequency intervals. The following guidelines may also be applied. For materiel that is likely to be exposed once to a given pyroshock event, perform one shock for each appropriate environmental condition. For materiel that is likely to be exposed more frequently to pyroshock events and there are little available data to substantiate the number of pyroshocks, apply three or more at each environmental condition based on the

anticipated service use. Application of three or more shocks in one configuration is for enhancement of statistical confidence.

2.3.3.2 Procedure I.

For Procedure I, subject the test item to a sufficient number of suitable shocks to meet the specified test conditions or at least three shocks, whichever is greater. The objective of the test is to test the physical and functional integrity of the materiel under service use pyroshock in the near-field of the pyrotechnic device.

2.3.3.3 Procedure II.

For Procedure II, subject the test item to a sufficient number of suitable shocks to meet the specified test conditions or at least three shocks. The objective of the test is to test the structural and functional integrity of the materiel under pyroshock in the near-field of the pyrotechnic device.

2.3.3.4 Procedure III.

For Procedure III, subject the test item to a sufficient number of suitable shocks to meet the specified test conditions or at least three shocks. The measured response test requirements may be satisfied along more than one axis with a single test shock configuration. Consequently, it is conceivable that a minimum of three test shock repetitions will satisfy the requirements for all directions of all three orthogonal axes. At the other extreme, a total of nine shocks are required if each shock only satisfies the test requirements in one direction of one axis. The objective of the test is to test the structural and functional integrity of the system under pyroshock in the far-field of the pyrotechnic device.

2.3.3.5 Procedure IV.

For Procedure IV, subject the test item to a sufficient number of suitable shocks to meet the specified test conditions or at least three shocks. The measured response will generally not be omni-directional. For Procedure IV, it may be possible, but highly unlikely, to simultaneously meet the test requirements along more than one axis with a single test shock configuration. Consequently, it is conceivable that a minimum of three test shock repetitions could satisfy the requirements for all directions of all three orthogonal axes. At the other extreme, a total of nine shocks are required if each shock only satisfies the test requirements in one direction of one axis. The objective of the test is to test the structural and functional integrity of the system under pyroshock in the far-field of the pyrotechnic device.

2.4 Test Item Configuration.

See Part One, paragraph 5.8. Configure the test item for pyroshock as would be anticipated for the materiel during service giving particular attention to the details of the mounting of the materiel to the platform. For Procedure II, provide special justification for the selection of the test item configuration. Pyroshock response variation is particularly sensitive to the details of the materiel/platform configuration.

3. INFORMATION REQUIRED.

3.1 Pretest.

The following information is required to conduct a pyroshock test adequately.

- a. General. Information listed in Part One, paragraphs 5.7 and 5.9, and Part One, Appendix A, Task 405 of this standard.
- b. Specific to this method.
 - (1) Test system (test item/platform configuration) detailed configuration including
 - (a) location of the pyrotechnic device
 - (b) location of the materiel

MIL-STD-810F
1 January 2000

- (c) the structural path between the pyrotechnic device and the materiel and any general coupling configuration of the pyrotechnic device to the platform and the platform to the materiel including the identification of structural joints
 - (d) distance of the closest part of the materiel to the pyrotechnic shock device
- (2) Pyroshock environment, including
- (a) type of pyrotechnic device
 - (b) if charge related - size of pyrotechnic device charge
 - (c) if charge effect - stored strain energy in primary device
 - (d) means of initiation of the pyrotechnic device
 - (e) anticipated EMI or thermal effects
- (3) Effective duration of pyroshock if Procedure III or Procedure IV is used, or the size and distribution of the pyrotechnic charge if Procedure I or Procedure II is used.
- (4) General materiel configuration including measurement points on or near the materiel.

3.2 During Test.

Collect the following information while conducting the test:

- a. General. Information listed in Part One, paragraph 5.10, and in Part One, Appendix A, Tasks 405 and 406 of this standard.
- b. Specific to this method.
 - (1) A means of assessing damage to fixture/materiel configurations before continuing the tests in Procedures I, II, and III.
 - (2) A record of previous shock time history information for analysis.
 - (3) An SRS analysis capability to determine if specified pyroshock levels are being replicated in Procedures II, III, and IV.

3.3 Post-test.

Record the following post-test information.

- a. General. Information listed in Part One, paragraph 5.13, and in Appendix A, Tasks 405 and 406 of this standard.
- b. Specific to this method.
 - (1) Duration of each exposure as recorded by the instrumented test fixture or test item, and the number of specific exposures.
 - (2) Any data measurement anomalies, e.g., high instrumentation noise levels, loss of sensors or sensor mount as a result of testing, etc.
 - (3) Status of the test item/fixture after each test.
 - (4) Status of measurement system after each test.

4. TEST PROCESS.

4.1 Test Facility.

Pyroshock can be applied utilizing actual pyrotechnic devices in the design configuration or in a simulated configuration, conventional high acceleration amplitude/frequency test input devices or, under certain restricted circumstances, an electrodynamic shaker. The pyroshock apparatus may incorporate a compressed gas shock tube, metal-on-metal contact, ordnance-generated pyroshock simulator, actual pyrotechnic device on a scale model, actual

pyrotechnic device on a full scale model, or other activating types. For Procedure I or Procedure II, references related to ordnance devices must be consulted. For Procedure III, reference c provides a source of alternative test input devices, their advantages and limitations. In Procedure III it is assumed that all parts of the materiel lie in the far-field of the pyrotechnic device. Consult reference c for guidelines and consideration for such testing. For Procedure IV, it is assumed that all parts of the materiel lie in the far-field of the pyrotechnic device and the measured or predicted data are consistent with the 3000 Hz frequency limitations of the electrodynamic shaker in addition to the acceleration amplitude limitations. It is also important to note that for large materiel, the velocity input of the shaker may exceed the velocity of the materiel under the actual pyroshock environment. For velocity sensitive materiel, this may constitute an overtest. In the ensuing paragraphs, the portion of the test facility responsible for delivering the pyroshock to the materiel will be termed the shock apparatus. Such shock apparatus includes the pyrotechnic shock device and the fixturing configuration in Procedure I and Procedure II, the mechanical exciter and the fixturing configuration in Procedure III, and the electrodynamic shaker and the fixturing configuration in Procedure IV.

4.2 Controls.

4.2.1 Calibration.

Ensure the shock apparatus is calibrated for conformance with the specified test requirement from the selected procedure. For Procedure I there is no pre-shock calibration other than ensuring the configuration is in accordance with the test plan. For Procedure II, before the test item is attached to the resonating plate, it will be necessary to attach a calibration load and obtain measured data under test conditions to be compared with the desired test response. Caution must be exercised so that the pre-test shocks do not degrade the resonating plate configuration. For Procedure III, calibration is crucial. Before the test item is attached to the shock apparatus, it will be necessary to attach a calibration load and obtain measured data under test conditions to be compared with the desired test response. For Procedure IV, utilizing the SRS method with proper constraints on the effective duration of the transient, calibration is necessary. Before the test item is attached to the shock apparatus, it will be necessary to attach a calibration load and obtain measured data under test conditions to be compared with the desired test response. For Procedure II, Procedure III, and Procedure IV, remove the calibration load and perform the shock test on the actual test item. Additional calibration procedures are provided in Part One, paragraph 5.3.2 and Part One, paragraph 5.2, respectively.

4.2.2 Tolerances.

The following are guidelines for test tolerances for pyroshock for the four procedures. All tolerances are specified on the maximax acceleration SRS. Any tolerances specified on the pseudo-velocity SRS must be derived from the tolerances on the maximax acceleration SRS and be consistent with those tolerances. For an array of measurements defined in terms of a "zone" (reference e) a tolerance may be specified in terms of an average of the measurements within a "zone". It should be noted, however, this is in effect a relaxation of the single measurement tolerance, and that individual measurements may be substantially out of tolerance while the average is within tolerance. In general, when specifying test tolerances based on averaging for more than two measurements within a zone, the tolerance band should not exceed the 95/50 one-sided normal tolerance upper limit computed for the logarithmically transformed SRS estimates, or be less than the mean minus 1.5dB. Any use of "zone" tolerances and averaging must have support documentation prepared by a trained analyst. Additional test tolerance procedures are provided in Part One, paragraph 5.3.2 and Part One, paragraph 5.2, respectively.

4.2.2.1 Procedures I and II.

If prior measured data are available or a series of pyroshocks are performed, all acceleration maximax SRS computed with a one-twelfth octave frequency resolution are to be within -3 dB and $+6$ dB over a minimum of 80% of the overall frequency bandwidth from 100 Hz to 20 kHz. For the remaining 20% part of the frequency band, all SRS are to be within -6 dB and $+9$ dB. Ensure that at least 50% of the SRS magnitudes exceed the nominal test specification.

MIL-STD-810F
1 January 2000

4.2.2.2 Procedure III.

If prior measured data are available or a series of pyroshocks are performed, all acceleration maximax SRS computed with a one-twelfth octave frequency resolution are to be within -3 dB and $+6$ dB over a minimum of 90% of the overall frequency bandwidth from 100 Hz to 10 kHz. For the remaining 10% part of the frequency band all SRS are to be within -6 dB and $+9$ dB. Ensure that at least 50% of the SRS magnitudes exceed the nominal test specification.

4.2.2.3 Procedure IV.

If prior measured data are available or a series of pyroshocks are performed, all acceleration maximax SRS computed with a one-twelfth octave frequency resolution are to be within -1.5 dB and $+3$ dB over a minimum of 90% of the overall frequency bandwidth from 10 Hz to 3 kHz. For the remaining 10% part of the frequency band all SRS are to be within -3 dB and $+6$ dB. Ensure that at least 50% of the SRS magnitudes exceed the nominal test specification.

4.3 Instrumentation.

In general, acceleration will be the quantity measured to meet specification with care taken to ensure acceleration measurements can be made that provide meaningful data (reference b). For pyroshock measurements in and close to the near-field, loss of measurement system integrity is not unusual. On occasion, more sophisticated devices may be employed, e.g., laser velocimeter. In these cases, give special consideration to the measurement instrument amplitude and frequency range specifications in order to satisfy the measurement and analysis requirements.

- a. Accelerometer.
 - (1) Transverse sensitivity of less than or equal to 5%.
 - (2) An amplitude linearity within 10% from 5% to 100% of the peak acceleration amplitude required for testing.
 - (3) For all pyroshock measurement procedures a flat frequency response within $\pm 10\%$ across the frequency range 10 - 20,000 Hz. The devices may be of the piezoelectric type or the piezoresistive type. Use measurement devices compatible with the requirements, guidelines, and precautions provided in reference b.
- b. Signal conditioning. Use signal conditioning compatible with the instrumentation requirements on the materiel. In particular, filtering will be consistent with the response time history requirements. Use signal conditioning compatible with the requirements and guidelines provided in reference b. In particular, use extreme care in filtering the acceleration signals either (1) directly at the attachment point, i.e., mechanical filtering to reduce the very high frequencies associated with the pyroshock, or (2) at the amplifier output. Never filter the signal into the amplifier for fear of filtering bad measurement data and the inability to detect the bad measurement data at the amplifier output. The signal from the signal conditioning or recording device must be anti-alias filtered before digitizing with a linear phase shift filter over the frequency range of interest.

4.4 Data Analysis.

- a. Digitizing will not alias more than a 5 percent measurement error into the frequency band of interest (100 Hz to 20 kHz).
- b. For filters used to meet the previous requirement, use a filter having linear phase-shift characteristics.
- c. A filter (if used) with a pass band flatness within one dB across the frequency range specified for the accelerometer (see paragraph 4.3).
- d. Analysis procedures will be in accordance with those requirements and guidelines provided in reference b. In particular, the pyroshock acceleration amplitude time histories will be validated according to the procedures in reference b. Each amplitude time history will be integrated to detect any anomalies in the measurement system e.g., cable breakage, slewrate of amplifier exceeded, data clipped, unexplained

accelerometer offset, etc. The integrated amplitude time histories will be compared against criteria given in reference b. For Procedure I and Procedure II to detect emission from extraneous sources, e.g., EMI, configure an accelerometer without sensing element and process its response in the same manner as for the other accelerometer measurements. If this accelerometer exhibits any character other than very low level noise, consider the acceleration measurements to be contaminated by an unknown noise source in accordance with the guidance in reference b.

4.5 Test Execution.

4.5.1 Preparation for test.

4.5.1.1 Preliminary steps.

Prior to initiating any testing, review pretest information in the test plan to determine test details (e.g., procedures, test item configuration, pyroshock levels, number of pyroshocks):

- a. Choose the appropriate test procedure.
- b. Determine the appropriate pyroshock levels for the test prior to calibration for Procedure II, Procedure III, and Procedure IV from previously processed data if this is available.
- c. Ensure the pyroshock signal conditioning and recording device have adequate amplitude range and frequency bandwidth. It may be difficult to estimate a peak signal and range the instrumentation appropriately. In general, there is no data recovery from a clipped signal, however, for over-ranged signal conditioning, it is usually possible to get meaningful results for a signal 20 dB above the noise floor of the measurement system. In some cases, redundant measurements may be appropriate - one measurement being over-ranged and one measurement ranged at the best estimate for the peak signal. The frequency bandwidth of most modern recording devices is usually adequate, but one must make sure that device input filtering does not limit the signal frequency bandwidth.

4.5.1.2 Pretest checkout.

All items require a pretest checkout at standard ambient conditions to provide baseline data. Conduct the checkout as follows:

- Step 1. Conduct a complete visual examination of the test item with special attention to micro-electronic circuitry areas. Pay particular attention to its platform mounting configuration and potential stress wave transmission paths.
- Step 2. Document the results.
- Step 3. Where applicable, install the test item in its test fixture.
- Step 4. Conduct an operational checkout in accordance with the approved test plan along with simple tests for ensuring the measurement system is responding properly.
- Step 5. Document the results for comparison with data taken during and after the test.
- Step 6. If the test item operates satisfactorily, proceed to the first test. If not, resolve the problem and restart at Step 1.
- Step 7. Remove the test item and proceed with the calibration (except for Procedure I).

4.5.1.3 Procedures.

The following procedures provide the basis for collecting the necessary information concerning the platform and test item under pyroshock.

a. Procedure I - Near-field with actual configuration.

- Step 1. Following the guidance of reference c, select test conditions and mount the test item (in general there will be no calibration when actual hardware is used in this procedure). Select accelerometers and analysis techniques that meet the criteria outlined in reference b.
- Step 2. Perform a functional check on the test item.

MIL-STD-810F
1 January 2000

- Step 3. Subject the test item (in its operational mode) to the test transient by way of the pyrotechnic test device.
- Step 4. Record necessary data that show the shock transients when processed with the SRS algorithm are within specified tolerances. This includes test setup photos, test logs, and plots of actual shock transients. For shock-isolated assemblies within the test item, make measurements and/or inspections to ensure these assemblies did attenuate the pyroshock.
- Step 5. Perform the functional check on the test item. Record performance data.
- Step 6. Repeat steps 2, 3, 4, and 5 a minimum of three times for statistical confidence if the integrity of the test configuration can be preserved during test.
- Step 7. Document the test series.

b. Procedure II - Near-field with simulated configuration.

- Step 1. Following the guidance of reference b, select test conditions and calibrate the shock apparatus as follows:
 - (a) Select accelerometers and analysis techniques that meet the criteria outlined in reference b.
 - (b) Mount the calibration load (an actual test item, a rejected item, or a rigid dummy mass) to the test apparatus in a manner similar to that of the actual materiel service mount. If the materiel is normally mounted on shock isolators to attenuate the pyroshock, ensure the isolators are functional during the test.
 - (c) Perform calibration shocks until two consecutive shock applications to the calibration load produce shock transients that, when processed with the SRS algorithm, are within specified tolerances for at least one direction of one axis.
 - (d) Remove the calibrating load and install the actual test item on the shock apparatus paying close attention to mounting details.
- Step 2. Perform a functional check on the test item.
- Step 3. Subject the test item (in its operational mode) to the test pyroshock.
- Step 4. Record necessary data that show the shock transients when processed with the SRS algorithm are within specified tolerances. If requirements are given in terms of more than one axis, examine responses in the other axes to ensure the test specification has been met. This includes test setup photos, test logs, and photos of actual shock transients. For shock isolated assemblies within the test item, make measurements and/or inspections to assure the isolators attenuated the pyroshock.
- Step 5. Perform the functional check on the test item. Record performance data.
- Step 6. Repeat steps 1, 2, 3, 4, and 5 three times for each orthogonal axis that is to be tested if the test shock did not meet the test specification in the other axes.
- Step 7. Document the test series.

c. Procedure III - Far-field using mechanical test device.

- Step 1. Following the guidance of reference b, select test conditions and calibrate the shock apparatus as follows:
 - (a) Select accelerometers and analysis techniques that meet the criteria outlined in reference b.
 - (b) Mount the calibration load (an actual test item, a rejected item, or a rigid dummy mass) to the test apparatus in a manner similar to that of the actual materiel service mount. If the materiel is normally mounted on shock isolators to attenuate the pyroshock, ensure the isolators are functional during the test.
 - (c) Perform calibration shocks until two consecutive shock applications to the calibration load produce waveforms that, when processed with the SRS algorithm, are within specified tolerances for at least one direction of one axis.
 - (d) Remove the calibrating load and install the actual test item on the shock apparatus paying close attention to mounting details.
- Step 2. Perform a functional check of the test item.
- Step 3. Subject the test item (in its operational mode) to the test pyroshock.
- Step 4. Record necessary data that show the shock transients when processed with the SRS algorithm are within specified tolerances. If requirements are given in terms of more than one axis, examine responses in the other axes to ensure the test specification has been met. This includes test setup

- photos, test logs, and photos of actual shock transients. For shock isolated assemblies within the test item, make measurements and/or inspections to assure the isolators attenuated the pyroshock.
- Step 5. Perform the functional check on the test item. Record performance data.
- Step 6. Repeat steps 1, 2, 3, 4, and 5 three times for each orthogonal axis that is to be tested if the test shock did not meet the test specification in the other axes.
- Step 7. Document the tests.

d. Procedure IV - Far-field using electrodynamic shaker.

- Step 1. Following the guidance of reference b, select test conditions and calibrate the shock apparatus as follows:
- Select accelerometers and analysis techniques that meet the criteria outlined in reference b.
 - Mount the calibration load (an actual test item, a rejected item, or a rigid dummy mass) to the electrodynamic shaker in a manner similar to that of the actual materiel. If the materiel is normally mounted on shock isolators to attenuate the pyroshock, ensure the isolators are functional during the test.
 - Develop the SRS wavelet or damped sine compensated amplitude time history based on the required test SRS.
 - Perform calibration shocks until two consecutive shock applications to the calibration load produce shock transients that, when processed with the SRS algorithm, are within specified test tolerances for at least one direction of one axis.
 - Remove the calibrating load and install the actual test item on the electrodynamic shaker paying close attention to mounting details.
- Step 2. Perform a functional check on the test item.
- Step 3. Subject the test item (in its operational mode) to the test electrodynamic pyroshock simulation.
- Step 4. Record necessary data that show the shock transients, when processed with the SRS algorithm, are within specified tolerances. If requirements are given in terms of more than one axis, examine responses in the other axes to ensure the test specification has been met. This includes test setup photos, test logs, and photos of actual shock transients. For shock isolated assemblies within the test item, make measurements and/or inspections to assure the isolators attenuated the pyroshock.
- Step 5. Perform the functional check on the test item. Record performance data.
- Step 6. Repeat steps 2, 3, 4, and 5 three times for each orthogonal axis that is to be tested if the test shock did not meet the test specification in the other axes.
- Step 7. Document the tests.

5. ANALYSIS OF RESULTS.

In addition to the guidance provided in Part One, paragraphs 5.14 and 5.17, and Part One, Appendix A, Tasks 405 and 406, the following information is provided to assist in the evaluation of the test results. Analyze in detail any failure of a test item to meet the requirements of the system specifications and consider related information such as:

5.1 Procedure I - Near-field with Actual Configuration.

Carefully evaluate any failure in the structural configuration of the test item, e.g., minute cracks in circuit boards, that may not directly impact failure of the functioning of the materiel but that would lead to failure in its in-service environment conditions.

5.2 Procedure II - Near-field with Simulated Configuration.

Carefully evaluate any failure in the structural configuration of the test item, e.g., minute cracks in circuit boards, that may not directly impact failure of the functioning of the materiel but that would lead to failure in its in-service environment conditions.

5.3 Procedure III - Far-field Using Mechanical Test Device.

The mechanical shock simulation will, in general, provide a more severe low frequency environment (comparatively large velocity and displacement) than the actual pyroshock event and, hence, any structural failures, e.g., deformed

MIL-STD-810F
1 January 2000

fasteners or mounts, may be more akin to those found in the SRS prescribed shock tests described in method 516.5. If this is the case and the cause of the structural failure is not readily apparent, another procedure may be required to satisfy the test requirements.

5.4 Procedure IV - Far-field Using Electrodynamic Shaker.

The mechanical shock simulation will, in general, provide a more severe low frequency environment (comparatively large velocity) than the actual pyroshock event and, hence, any structural failures may be more akin to those found in the SRS prescribed shock tests described in method 516.5. If this is the case and the cause of the structural failure is not readily apparent, another procedure may be required to satisfy the test requirements.

6. REFERENCE/RELATED DOCUMENTS.

- a. "Pyroshock Test Criteria," NASA Technical Standard, NASA-STD-7003, May 18, 1999.
- b. Handbook for Dynamic Data Acquisition and Analysis, IES-RP-DTE012.1, Institute of Environmental Sciences, 940 East Northwest Highway, Mount Prospect, Illinois 60056.
- c. Bateman, V. I. and N. T. Davie, Recommended Practice for Pyroshock, IES Proceedings of the 42nd ATM 1995, Institute of Environmental Sciences, Mount Prospect, Illinois.
- d. Zimmerman, Roger M., Section 32, VII. Shock Test Techniques, 3) Pyroshock-Bibliography, Experimental Mechanics Division I, Sandia National Laboratories, Albuquerque, NM, April 19, 1991.
- e. Kelly, Ronald D. and George Richman, Principles and Techniques of Shock Data Analysis, The Shock and Vibration Information Center, SVM-5, United States Department of Defense.
- f. Harris, Cyril M., ed. Shock and Vibration Handbook, 3rd Edition, NY, McGraw-Hill, 1988.
- g. Gaberson, H. A. and R. H. Chalmers. Modal Velocity as a Criterion of Shock Severity, Shock and Vibration Bulletin 40, Pt. 2, (1969) 31-49.
- h. Gaberson, H. A. and R. H. Chalmers. Reasons for Presenting Shock Spectra with Velocity as the Ordinate, Proc. 66th Shock and Vibration Symp., Vol. II, pp 181-191, Oct/Nov. 1995.
- i. Smallwood, David O., Characterization and Simulation of Transient Vibrations Using Band Limited Temporal Moments, Shock and Vibration Journal, Volume 1, Issue 6, 1994, pp 507-527.
- j. Merritt, Ronald G., A Note on Transient Vibration Model Detection, IES Proceedings of the 42nd ATM 1995, Institute of Environmental Sciences, Mount Prospect, Illinois.
- k. Newland, D. E., An Introduction to Random Vibrations, Spectral & Wavelet Analysis, John Wiley & Sons, Inc., New York 1995.
- l. Piersol, Allan G., Procedures to Compute Maximum Structural Responses from Predictions or Measurements at Selected Points, Shock and Vibration Journal, Vol 3, Issue 3, 1996, pp 211-221.
- m. Barrett, S., The Development of Pyro Shock Test Requirements for Viking Lander Capsule Components, Proc. 21st ATM, Inst. Envir. SC., pp 5-10, Apr. 1975.
- n. Kacena, W. J., McGrath, M. B., and Rader, W. P., Aerospace Systems Pyrotechnic Shock Data, NASA CR-116437, -116450, -116401, -116402, -116403, -116406, and - 116019, Vol. I-VII, 1970.
- o. MIL-STD-331, "Fuze and Fuze Components, Environmental and Performance Tests for."
- p. Himelblau, Harry, Dennis L. Kern, Allan G. Piersol, and Sheldon Rubin, Guidelines for Dynamic Environmental Criteria (Preliminary Draft), Jet Propulsion Laboratory, California Institute of Technology, March 1997.

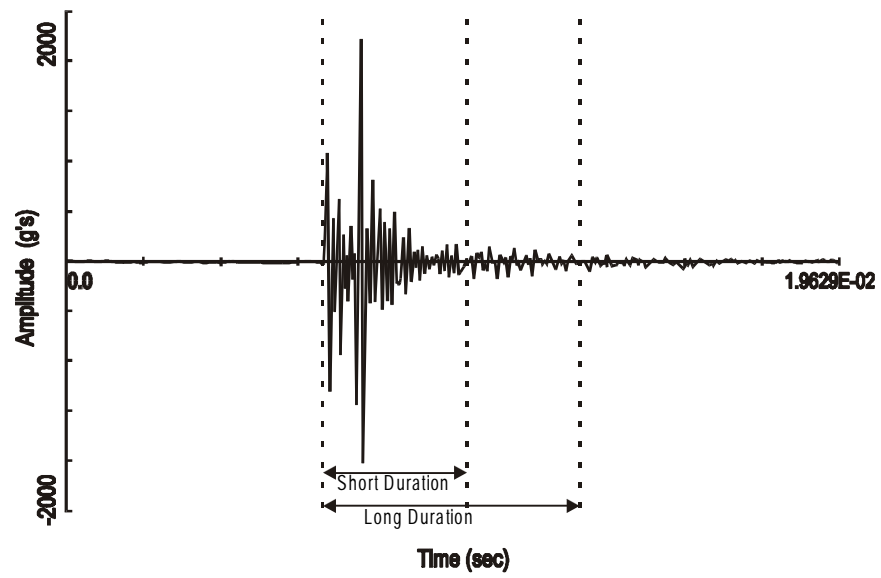

FIGURE 517-1. Total event pyroshock time history.

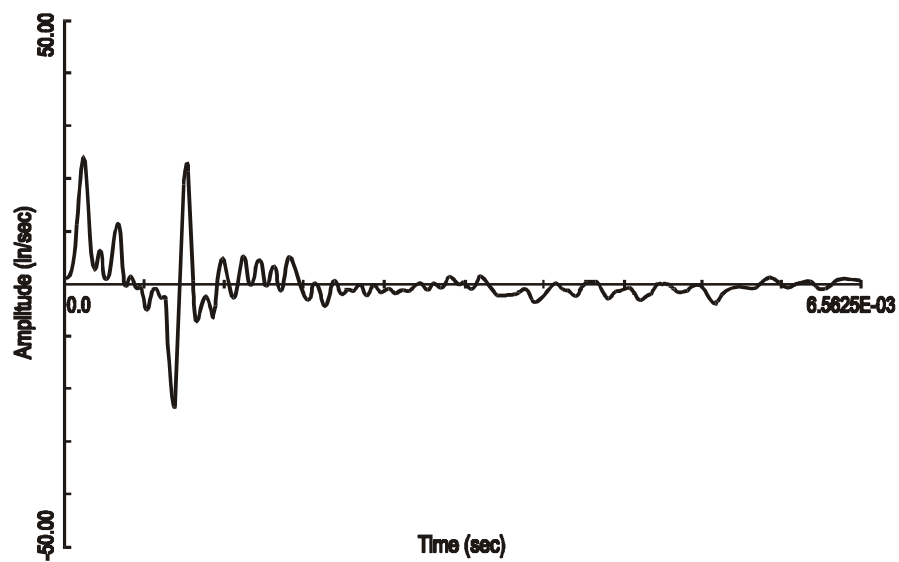

FIGURE 517-2. Long duration pyroshock velocity time history.

MIL-STD-810F
1 January 2000

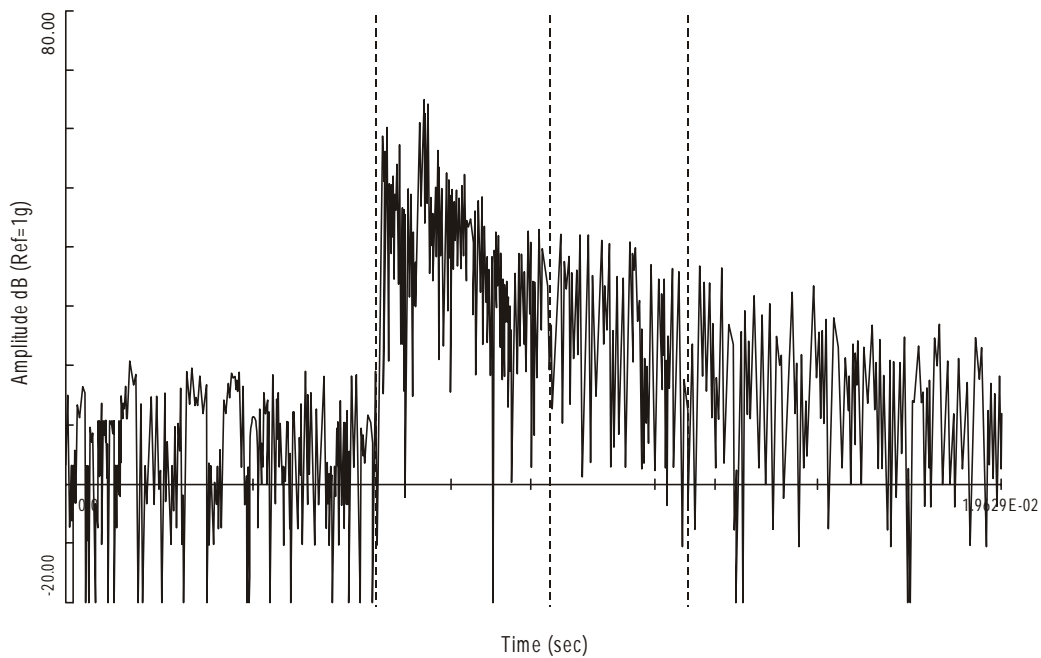

FIGURE 517-3. Absolute value magnitude time history.

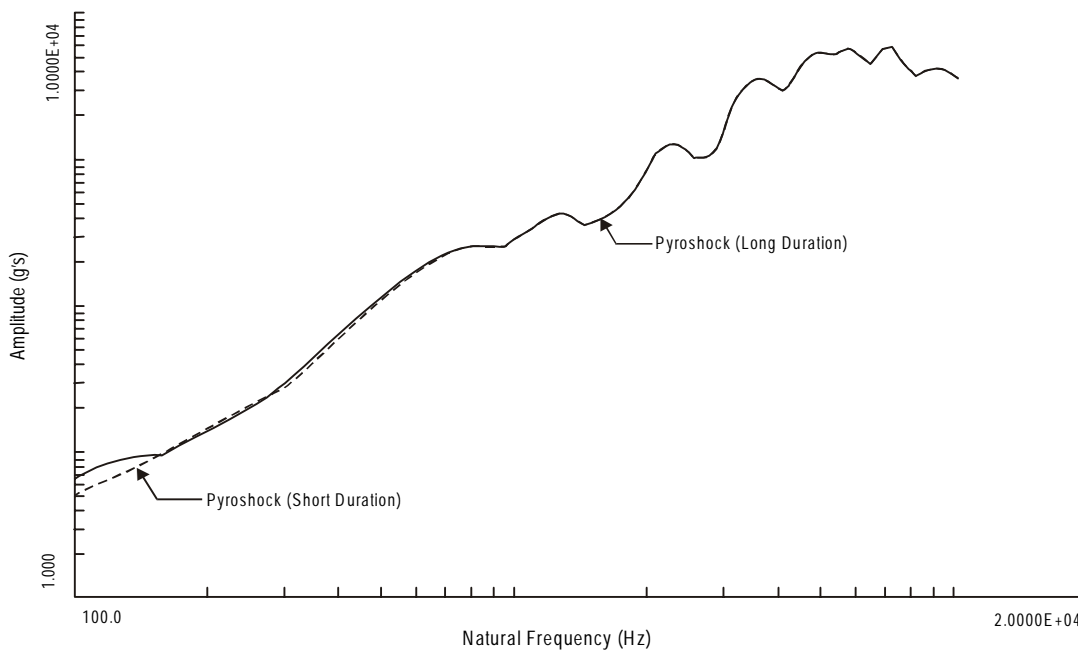

FIGURE 517-4. Acceleration maximax SRS -(long vs short duration).

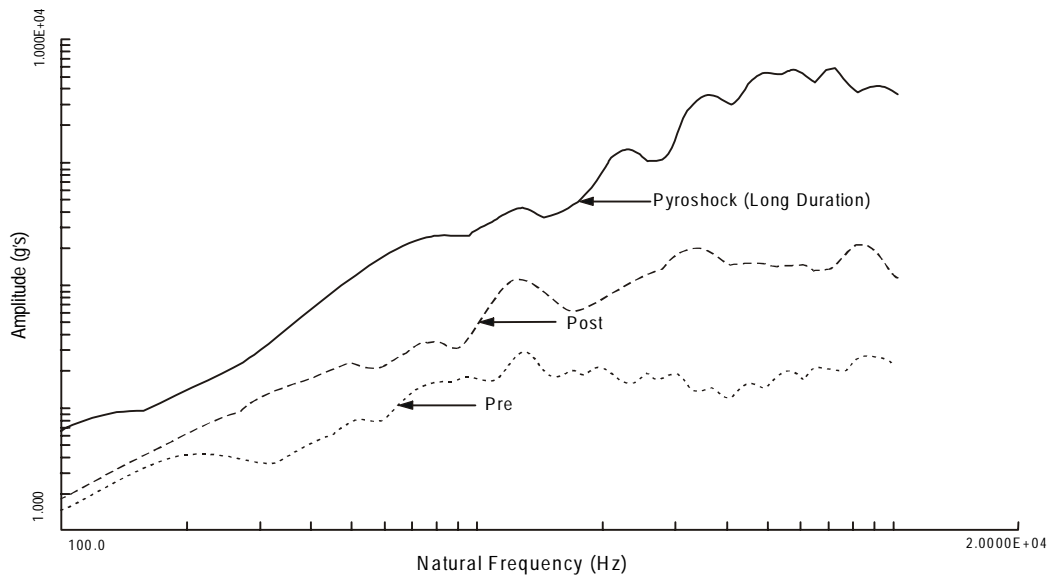

FIGURE 517-5. Acceleration maximax SRS for the pyroshock, pre-pyroshock & post pyroshock.

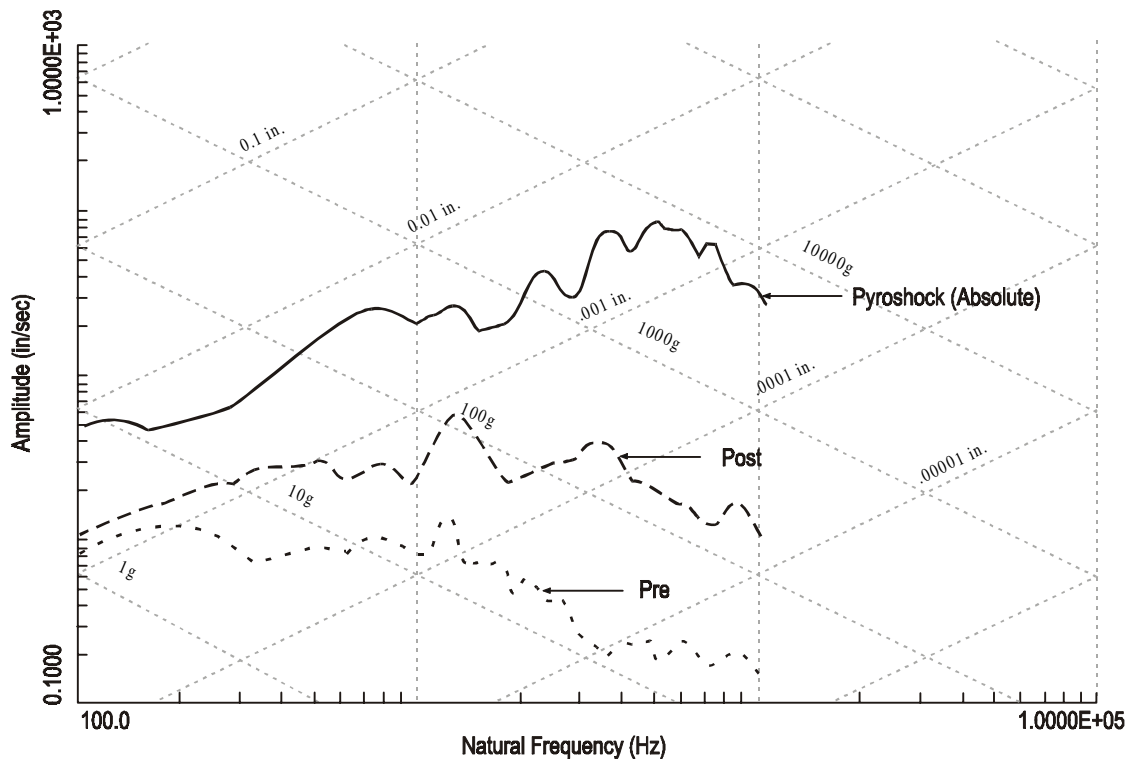

FIGURE 517-6. Maximax pseudo-velocity response spectrum for the pyroshock, pre-pyroshock and post pyroshock.

MIL-STD-810F
1 January 2000

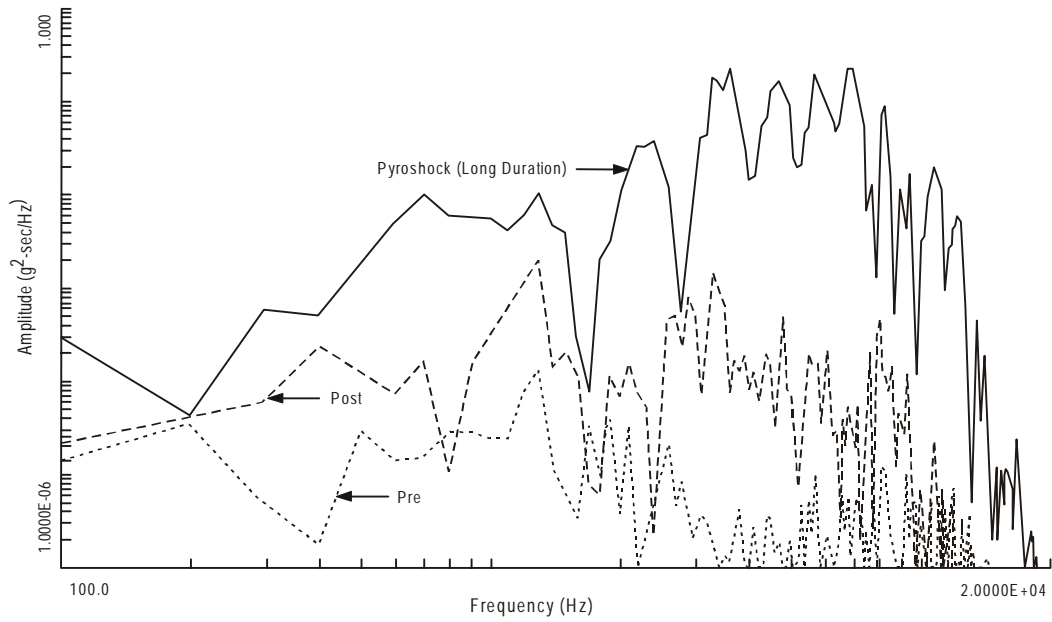

FIGURE 517-7. Acceleration energy spectral density estimates.

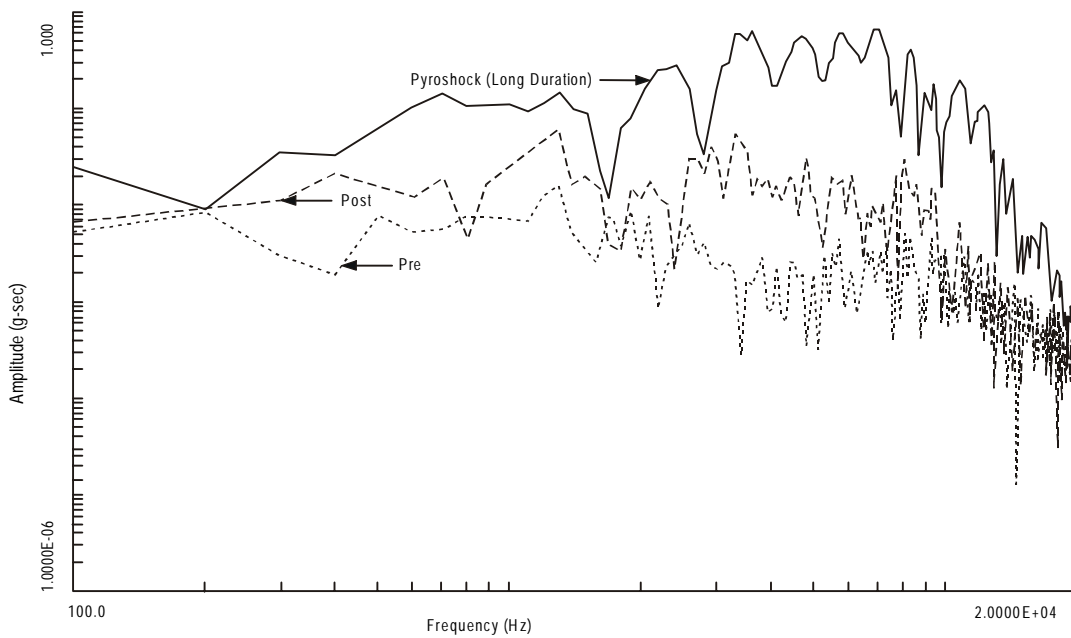

FIGURE 517-8. Acceleration Fourier transform estimates.

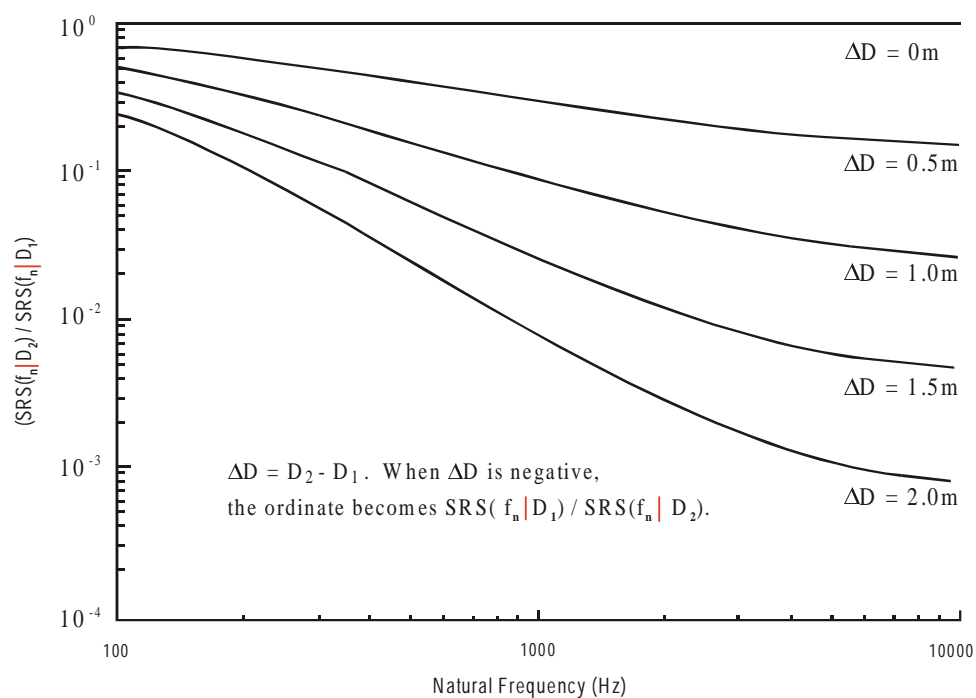

FIGURE 517-9. Correction of shock response spectrum for distance from pyrotechnic source.

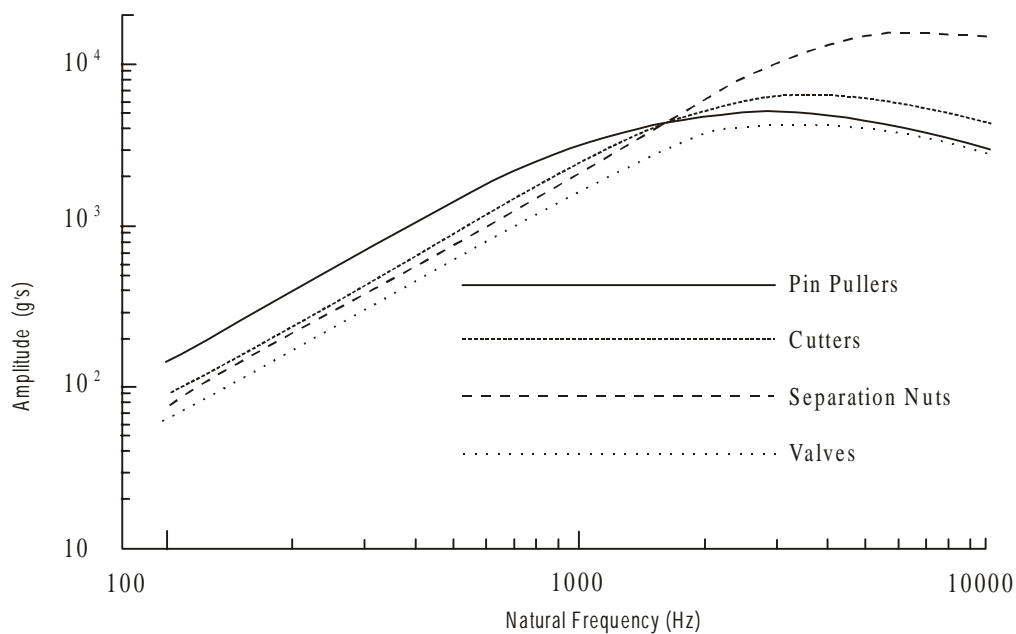

FIGURE 517-10. Shock response spectra for various point source pyrotechnic devices.

MIL-STD-810F
1 January 2000

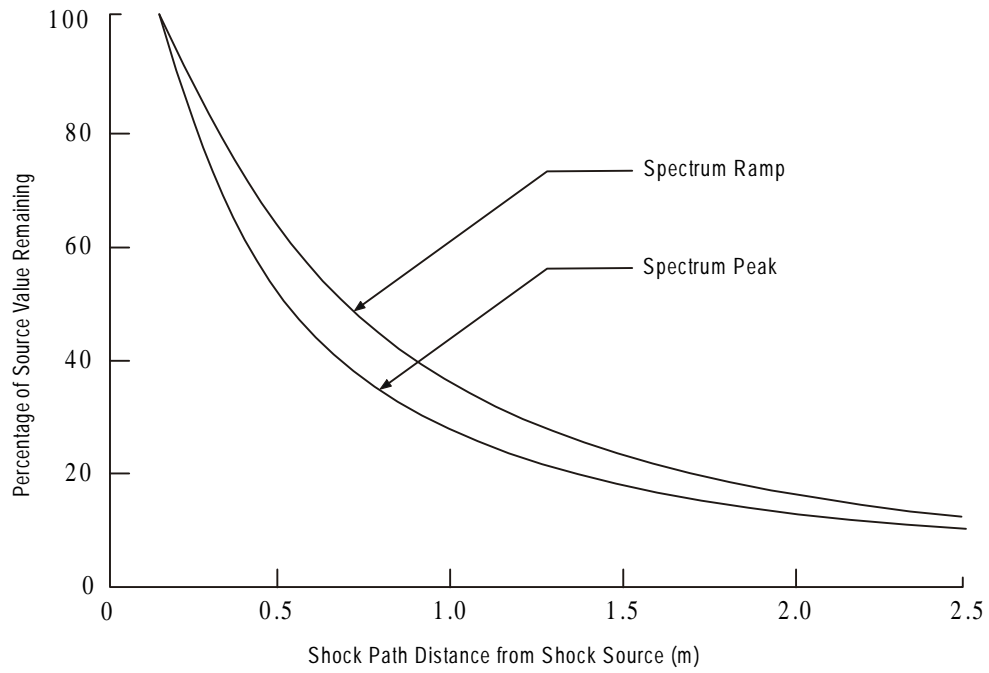

FIGURE 517-11. Shock response spectrum vs distance from pyrotechnic source.

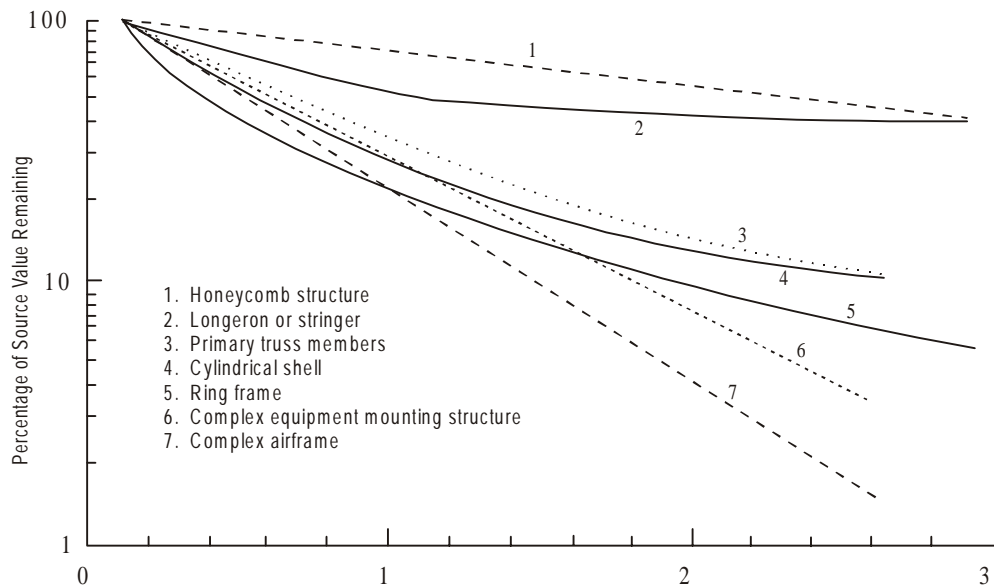

FIGURE 517-12. Peak pyroshock response vs distance from pyrotechnic source.

METHOD 518

ACIDIC ATMOSPHERE

NOTE: Tailoring is essential. Select methods, procedures and parameter levels based on the tailoring process described in Part One, paragraph 4.2.2, and Appendix C. Apply the general guidelines for laboratory test methods described in Part One, paragraph 5 of this standard.

1. SCOPE.

1.1 Purpose.

Use the acidic atmosphere test to determine the resistance of materials and protective coatings to corrosive atmospheres.

1.2 Application.

Use this test method when the requirements documents state that the materiel is likely to be stored or operated in areas where acidic atmospheres exist, such as industrial areas or near the exhausts of any fuel-burning device.

1.3 Limitations.

This method is not a replacement for the salt fog method, nor is it suitable for evaluating the effects of hydrogen sulfide that readily oxidizes in the test environment to form sulfur dioxide.

2. GUIDANCE/REQUIREMENTS.

2.1 Effects of the Environment.

Acidic atmospheres are of increasing concern, especially for materiel in the vicinity of industrial areas or near the exhausts of fuel burning devices. Examples of problems that could occur as a result of acidic atmosphere exposure are as follows. The list is not intended to be all-inclusive, and some of the examples may overlap the categories. Reference a. provides further information.

- a. Chemical attack of surface finishes and non-metallic materials.
- b. Corrosion of metals.
- c. Pitting of cement and optics.

2.2 Test Procedure.

When an acidic atmosphere test is deemed necessary, the procedure included in this method is considered suitable for most applications. The tailoring options are limited.

2.3 Sequence.

- a. General. See Part One, paragraph 5.5.
- b. Unique to this method. There are at least two philosophies related to test sequence. One approach is to conserve test item life by applying what are perceived to be the least damaging environments first. For this approach, generally apply the acidic atmosphere test late in the test sequence. Another approach is to apply environments to maximize the likelihood of disclosing synergetic effects. For this approach, consider acidic atmosphere testing following dynamic tests, such as vibration and shock. Perform acidic atmosphere testing after any humidity or fungus testing, and before any sand and dust testing or other

MIL-STD-810F
1 January 2000

tests which damage protective coatings. Because this test is similar in severity to the salt fog test, recommend separate test items be used for each.

- Sand and dust testing deposits may inhibit acid effects as well as abrade protective coatings;
- Acid deposits may inhibit mold/fungal growth;
- Residual deposits may accelerate chemical reactions during humidity testing.

2.4 Determine Test Levels and Conditions.

Having selected this method and relevant procedures (based on the test item's requirements documents and the tailoring process), complete the tailoring process by identifying appropriate parameter levels and applicable test conditions and techniques for these procedures. Base these selections on the requirements documents, the Life Cycle Environmental Profile, Operational Environment Documentation (see Part One, figure 1-1), and information provided with this procedure. Consider the essential parameters for defining the acidic atmosphere test that include exposure temperature, exposure time (duration), test item configuration, chemical composition of the test atmosphere, and concentration of the test solution.

2.4.1 Temperature severities.

The test method and the exposure temperature used in this procedure are similar to that used in the salt fog test.

2.4.2 Test duration.

Two severity levels are defined (reference b.). In view of the complexity of naturally occurring corrosion processes, no strict equivalencies with real exposure can be quoted. Use severity "a" below for simulating infrequent periods of exposure, or for exposure in areas of much lower acidity. Use severity "b" below to represent approximately 10 years natural exposure in a moist, highly industrial area, or a shorter period in close proximity to vehicle exhaust systems, particularly ship funnel exhausts where the potential acidity is significantly higher.

- a. Three 2-hour spraying periods with 22 hours storage after each.
- b. Four 2-hour spraying periods with 7 days storage after each.

2.4.3 Test item configuration.

The configuration of the materiel is an important factor in how an acidic atmosphere affects it. Therefore, during the test use the anticipated configuration of the materiel during storage or use. As a minimum, consider the following configurations:

- a. In a shipping/storage container or transit case.
- b. Protected or unprotected.
- c. Deployed (realistically or with restraints, such as with openings that are normally covered).
- d. Modified with kits for special applications.

2.4.4 Chemical composition and concentration.

For spraying, use a test solution containing 11.9mg (6 μ l) sulfuric acid (95-98%)/4 liters of solution and 8.8mg (6 μ l) nitric acid (68-71%)/4 liters solution in distilled or deionized water. This will produce a solution with a pH of 4.17 which is representative of some of the worst rain pH's recorded for rainfall in the eastern United States and other heavily industrialized areas with acidic emissions. Reference c. provides information regarding the more common chemical environmental contaminants together with some consequent likely forms of corrosion that material could encounter.

WARNING: *Strong acids are hazardous. The solution to be sprayed is harmful to people and clothing. Operators carrying out the test must take suitable precautions.*

WARNING: *Refer to the supplier's Material Safety Data Sheet (MSDS) or equivalent for health hazard data.*

- a. Do not enter the chamber during spraying and, before entry after spraying, purge the chamber with clean air to a level that will satisfy local safety requirements. Continue purging at intervals if necessary to ensure the concentration of noxious fumes remains at a suitably low level.
- b. Wear a suitable respirator and/or eye protection. Use rubber gloves to handle materiel.
- c. See paragraph 4.1b for hazardous waste disposal information.

2.4.5 Operational considerations.

The test item will not normally be required to function during the test, but may be required to do so upon completion of the test, or on completion of a representative sequence of environmental tests.

3. INFORMATION REQUIRED.

3.1 Pretest.

The following information is required to conduct acidic atmosphere tests adequately.

- a. General. Information listed in Part One, paragraphs 5.7 and 5.9, and Appendix A, Task 405 of this standard.
- b. Specific to this method.
 - (1) Areas of the test item visually and functionally examined and an explanation of their inclusion or exclusion.
 - (2) Whether the test is a demonstration of performance or survival.
 - (3) Whether the requirement is to demonstrate safety, safety and performance, or resistance to chemical attack after the test.
 - (4) If functional performance is to be assessed, the phases of the test when the test item is to function and be assessed, and the levels of performance required.

3.2 During Test.

Collect the following information during conduct of the test:

- a. General. Information listed in Part One, paragraph 5.10, and in Appendix A, Task 406 of this standard.
- b. Specific to this method.
 - (1) Record of chamber temperature versus time conditions.
 - (2) Fallout quantities per unit of time (see paragraph 4.1g).
 - (3) pH.

3.3 Post Test.

The following post test information is required.

- a. General. Information listed in Part One, paragraph 5.13, and in Appendix A, Task 406 of this standard.
- b. Specific to this method.
 - (1) Areas of the test item visually and functionally examined and an explanation of their inclusion or exclusion.
 - (2) Test variables:
 - (a) Test solution pH.
 - (b) Test solution fallout rate (ml/cm²/hr).

MIL-STD-810F
1 January 2000

- (3) Results of examination for corrosion, electrical, and physical effects.
- (4) Observations to aid in failure analysis.

4. TEST PROCESS.

4.1 Test Facility.

- a. For construction of the chamber, supporting racks, and spraying equipment use materials inert to the acid solution being sprayed, and that will not cause electrolytic corrosion with material with which it comes in contact.
- b. Ensure the test chamber has a waste collection system so that all waste material can be tested prior to disposal. Dispose of any material determined to be hazardous waste in accordance with local, state, and federal regulations.
- c. Do not respray acidic test solution drippings from the walls and ceilings of the chamber and from the test item. Vent the exposure chamber to prevent pressure buildup.
- d. Use a chamber capable of maintaining temperatures in the exposure zone at $35 \pm 2^\circ\text{C}$. Continuously control this temperature during the test. Do not use immersion heaters within the chamber exposure area for the purpose of maintaining the temperature within the exposure zone.
- e. Use an acid solution reservoir and dispenser made of material that is non-reactive with the acid solution, e.g., glass, hard rubber, or plastic. The reservoir provides a continuous supply to a tank normally (but not necessarily) situated inside the test section in which the acid solution level is held reasonably constant. The atomizers are connected to this tank.
- f. Use a chamber with a means for injecting the acid solution into the test chamber and with an input air humidifier to minimize clogging of the nozzles. Use atomizers of such design and construction as to produce a finely divided, wet, dense fog. Use atomizing nozzles and a piping system made of material that is non-reactive to the acid solution. Use a facility designed to provide the required atomization distribution and fallout.
- g. Use a test setup that includes a minimum of 2 fallout collection receptacles. One is to be at the perimeter of the test item nearest to the nozzle, and the other also at the perimeter of the test item but at the farthest point from the nozzle. If multiple nozzles are used, the same principles apply. Place the receptacles so that they are not shielded by the test item and will not collect drops of solution from the test item or other sources.
- h. Constant air pressure for the continuous, uniform atomization of the acid solution using a compressed air supply, and produce a fallout such that each receptacle collects from 1 to 3 ml of solution per hour for each 80 cm^2 of horizontal collecting area (10 cm diameter).

4.2 Controls.

- a. Compressed air. Preheat the oil and dirt-free compressed air used to produce the atomized solution (to offset the cooling effects of expansion to atmospheric pressure) and pre-humidify it such that the temperature is $35 \pm 2^\circ\text{C}$ and the relative humidity is in excess of 85% at the nozzle (see table 518-I).
- b. Preheating. Heat the acid solution to within $\pm 6^\circ\text{C}$ of the test section temperature before injection into the test section.
- c. Test section air circulation. Use an air velocity in the test chambers that is minimal (essentially zero).

TABLE 518-I. Temperature and pressure requirements for operation at 35°C.

| Air Pressure (kPa) | 83 | 96 | 110 | 124 |
|--|----|----|-----|-----|
| Preheat temperature (°C) (before atomizing) | 46 | 47 | 48 | 49 |

4.3 Test Interruptions.

- a. General. See Part One, paragraph 5.11 of this standard.
- b. Specific to this method.
 - (1) Undertest interruption. If an unscheduled test interruption occurs that causes the test conditions to exceed allowable tolerances toward standard ambient conditions, give the test item a complete visual examination and develop a technical evaluation of the impact of the interruption on the test results. Restart the test at the point of interruption and restabilize the test item at the test conditions.
 - (2) Overtest interruption. If an unscheduled test interruption occurs that causes the test conditions to exceed allowable tolerances away from standard ambient conditions, stabilize the test conditions to within tolerances and hold them at that level until a complete visual examination and technical evaluation can be made to determine the impact of the interruption on test results. If the visual examination or technical evaluation results in a conclusion that the test interruption did not adversely affect the final test results, or if the effects of the interruption can be nullified with confidence, restabilize the pre-interruption conditions and continue the test from the point where the test tolerances were exceeded.

4.4 Procedure.

The following test procedure provides a basis for assessing the suitability of the test item in an acidic atmosphere environment, and has limited tailorability.

4.4.1 Pretest information.

See General Guidance and Information, paragraphs 5 and 6.1.

4.4.2 Preparation for test.

- a. Prepare a test solution as specified in paragraph 2.4.4. NOTE: MAKE THE SOLUTION BY ADDING ACID TO WATER, NOT VICE VERSA.

WARNING: *Strong acids are hazardous. The solution to be sprayed is harmful to people and clothing. Operators carrying out the test must take suitable precautions.*

WARNING: *Refer to the supplier's Material Safety Data Sheet (MSDS) or equivalent for health hazard data.*

- (1) Do not enter the chamber during spraying. Before entry after spraying, purge the chamber with clean air to a level that will satisfy local safety requirements. Continue purging at intervals if necessary to ensure the concentration of noxious fumes remains at a suitably low level.
 - (2) Wear a suitable respirator and/or eye protection. Use rubber gloves to handle materiel.
- b. Chamber performance verification: Immediately before the test and with the exposure chamber empty, adjust all test parameters to those levels required for the test. Maintain these conditions for at least one 24-hour period (or until proper operation and fallout collection can be verified). With the exception of fallout rate, continuously monitor all test parameters to verify that the test chamber is operating properly.

MIL-STD-810F
1 January 2000

- c. Conduct an operational checkout in accordance with the test plan and record the results for compliance with Part One, paragraph 5.9. Handle the test item as little as possible, particularly on the significant surfaces, and prepare it for test immediately before exposure. Unless otherwise specified, use test items free of surface contamination such as oil, grease, or dirt, which could cause dewetting. Do not include the use of corrosive solvents, solvents which deposit either corrosive or protective films, or abrasives other than pure magnesium oxide in the cleaning methods.

4.4.3 Acidic atmosphere test procedure.

- Step 1. With the test item installed in the test chamber in its storage configuration (or as otherwise specified in the requirements documents), adjust the test chamber temperature to 35°C and temperature condition the test item for at least 2 hours before introducing the acid solution.
- Step 2. Expose the test item to one of the two following severities as specified in the test plan. (See paragraph 2.4.2.)
 - a. Four 2-hour spraying periods with 7 days storage after each.
 - b. Three 2-hour spraying periods with 22 hours storage after each.
- Step 3. At the completion of Step 2, stabilize the test item at standard ambient conditions.
- Step 4. Visually examine the test item to the extent practical.
- Step 5. If required, place the test item in an operational configuration and conduct an operational check of the test item.
- Step 6. If required, test items may be cleaned by rinsing in distilled/deionized water and dried by the application of heat (up to 55°C), where this is acceptable, or by other means. Collect the rinse water and check it for hazardous substances prior to disposal (see paragraph 4.1b also).
- Step 7. At the end of this test, and in conformity with the requirements documents, examine the test item for corrosion and deterioration of parts, finishes, materials, and components.

5. ANALYSIS OF RESULTS.

In addition to the guidance provided in Part One, paragraphs 5.14 and 5.17, the following information is provided to assist in the evaluation of the test results. Analyze any corrosion for its immediate effect on the satisfactory functioning of the test item. Satisfactory operation following this test is not the sole criterion for pass/fail.

6. REFERENCE/RELATED DOCUMENTS.

- a. DEF STAN 00-50, Guide to Chemical Environmental Contaminants and Corrosion Affecting the Design of Military Materiel. (UK)
- b. IEC 68-2-52, 1966, Test Kb, Salt Mist, Cyclic, NaCl solution.
- c. Acid Deposition in the United Kingdom, Warren Spring Laboratory, ISBN 085624 323X. (UK)
- d. NATO STANAG 4370, Environmental Testing.
- e. NATO Allied Environmental Conditions and Test Publication (AECTP) 300, Climatic Environmental Tests, Method 319, "Acidic Atmosphere."

METHOD 519.5

GUNFIRE VIBRATION

CONTENTS

| <u>Paragraph</u> | <u>Page</u> |
|--|-------------|
| 1. SCOPE | 1 |
| 1.1 Purpose..... | 1 |
| 1.2 Application..... | 1 |
| 1.3 Limitations..... | 2 |
| 2. TAILORING GUIDANCE | 2 |
| 2.1 Selecting the Gunfire Method. | 2 |
| 2.1.1 Effects of gunfire..... | 2 |
| 2.1.2 Sequence among other methods..... | 2 |
| 2.2 Selecting a Procedure..... | 3 |
| 2.2.1 Procedure selection considerations..... | 3 |
| 2.2.2 Difference among procedures..... | 4 |
| 2.3 Determine Test Levels and Conditions..... | 4 |
| 2.3.1 General considerations..... | 5 |
| 2.3.2 Test conditions..... | 5 |
| 2.3.3 Test axes and number of gunfire events..... | 5 |
| 2.4 Test Item Configuration..... | 5 |
| 2.5 Controls..... | 5 |
| 2.5.1 Control options..... | 5 |
| 2.5.1.1 Open loop..... | 5 |
| 2.5.1.2 Single point control..... | 5 |
| 2.5.1.3 Multiple point control..... | 6 |
| 2.5.2 Control methods..... | 6 |
| 2.5.2.1 Waveform control..... | 6 |
| 2.5.2.2 Random vibration control..... | 6 |
| 3. INFORMATION REQUIRED | 6 |
| 3.1 Pretest..... | 6 |
| 3.2 During Test..... | 7 |
| 3.3 Post-test..... | 7 |
| 4. TEST PROCESS | 7 |
| 4.1 Test Facility..... | 7 |
| 4.2 Controls..... | 8 |
| 4.2.1 Direct reproduction of measured materiel response data..... | 8 |
| 4.2.2 Statistically generated repetitive pulse – mean (deterministic) plus residual (stochastic) pulse | 8 |
| 4.2.3 Repetitive pulse shock response spectrum | 8 |
| 4.2.4 High level random vibration/sine-on-random vibration/narrowband random-on-random vibration..... | 9 |
| 4.3 Instrumentation..... | 9 |
| 4.4 Data Analysis..... | 9 |
| 4.5 Test Execution..... | 10 |
| 4.5.1 Preparation for test..... | 10 |

MIL-STD-810F
1 January 2000

CONTENTS

| <u>Paragraph</u> | <u>Page</u> |
|--|-------------|
| 4.5.1.1 Preliminary guidelines..... | 10 |
| 4.5.1.2 Pretest checkout..... | 10 |
| 4.5.1.3 Procedure overview..... | 10 |
| 4.5.1.4 Test item considerations..... | 11 |
| 4.5.2 Procedure I - Direct reproduction of measured materiel response data..... | 11 |
| 4.5.2.1 Controls..... | 11 |
| 4.5.2.2 Test tolerances..... | 11 |
| 4.5.2.3 Procedure steps..... | 11 |
| 4.5.2.4 Analysis of results..... | 12 |
| 4.5.3 Procedure II - Statistically generated repetitive pulse – mean (deterministic) plus residual (stochastic) pulse..... | 12 |
| 4.5.3.1 Controls..... | 12 |
| 4.5.3.2 Test tolerances..... | 12 |
| 4.5.3.3 Procedure steps..... | 12 |
| 4.5.3.4 Analysis of results..... | 13 |
| 4.5.4 Procedure III – Repetitive pulse shock response spectrum (SRS)..... | 13 |
| 4.5.4.1 Controls..... | 13 |
| 4.5.4.2 Test tolerances..... | 13 |
| 4.5.4.3 Procedure steps..... | 13 |
| 4.5.4.4 Analysis of results..... | 13 |
| 4.5.5 Procedure IV - High level random vibration/sine-on-random vibration/narrowband random-on-random vibration..... | 14 |
| 4.5.5.1 Controls..... | 14 |
| 4.5.5.2 Test tolerances..... | 14 |
| 4.5.5.3 Procedure steps..... | 14 |
| 4.5.5.4 Analysis of results..... | 15 |
| 5. REFERENCE/RELATED DOCUMENTS..... | 15 |
| ANNEX A. DIRECT REPRODUCTION OF MEASURED MATERIEL RESPONSE DATA | |
| 1. SCOPE..... | 1 |
| 1.1 Purpose..... | 1 |
| 1.2 Application..... | 1 |
| 2. DEVELOPMENT..... | 1 |
| 2.1 Basic Considerations for Environment Determination..... | 1 |
| 2.2 Test Configuration..... | 1 |
| 2.3 Creating a Digital File of the Gunfire Vibration Materiel Response..... | 1 |
| 2.4 Characterization of Vibration Exciter Drive Signal/Test Item Inverse Frequency Response Function..... | 2 |
| 2.5 Tapering the Inverse Frequency Response Function..... | 2 |
| 2.6 Computing the Impulse Response Function..... | 2 |
| 2.7 Computing the Compensated Vibration Exciter Drive Signal..... | 2 |
| 2.8 Reproducing the Gunfire Materiel Response..... | 2 |
| 2.9 Conclusion..... | 3 |
| 2.10 Reference/Related Documents..... | 3 |

METHOD 519.5

CONTENTS

| <u>Paragraph</u> | | <u>Page</u> |
|------------------|--------------------------------|-------------|
| 3. | RECOMMENDED PROCEDURES. | 3 |
| 3.1 | Recommended Procedure..... | 3 |
| 3.2 | Uncertainty Factors..... | 3 |

FIGURES

| | | |
|------------------|--|---|
| FIGURE 519.5A-1. | Digital flight data. | 4 |
| FIGURE 519.5A-2. | Swept sine vibration exciter input with resulting test item response..... | 4 |
| FIGURE 519.5A-3. | Modulus and phase of inverse frequency response function. | 5 |
| FIGURE 519.5A-4. | Modulus and phase of tapered inverse frequency response function. | 5 |
| FIGURE 519.5A-5. | Impulse response function..... | 6 |
| FIGURE 519.5A-6. | Compensated vibration exciter drive signal along with resulting test item response..... | 6 |
| FIGURE 519.5A-7. | Comparison of measured gunfire materiel response with laboratory simulated gunfire test item response..... | 7 |

**ANNEX B. STATISTICALLY GENERATED REPETITIVE PULSE – MEAN
(DETERMINISTIC) PLUS RESIDUAL (STACHASTIC) PULSE**

| | | |
|-----------|--|----------|
| 1. | SCOPE. | 1 |
| 1.1 | Purpose..... | 1 |
| 1.2 | Application..... | 1 |
| 2. | DEVELOPMENT. | 1 |
| 2.1 | Nomenclature for Annex B..... | 1 |
| 2.2 | Introduction. | 2 |
| 2.3 | Assumptions. | 2 |
| 2.4 | Modeling and Statistics for Description of a Materiel Response Time-varying Random Process. | 3 |
| 2.5 | Specific Application of the Model to the Measured Materiel Response. | 5 |
| 2.6 | Implementation. | 6 |
| 2.7 | References/Related Documents..... | 6 |
| 3. | RECOMMENDED PROCEDURES. | 7 |
| 3.1 | Recommended Procedure..... | 7 |
| 3.2 | Uncertainty Factors..... | 7 |

FIGURES

| | | |
|-------------------|---|----|
| FIGURE 519.5B-1. | Fifty round 30mm gunfire event. | 8 |
| FIGURE 519.5B-2. | Ensemble sample time history pulse (pulse 37). | 8 |
| FIGURE 519.5B-3. | Ensemble residual sample time history pulse (pulse 37). | 8 |
| FIGURE 519.5B-4. | Ensemble time-varying mean estimate. | 9 |
| FIGURE 519.5B-5. | Ensemble time-varying standard deviation estimate. | 9 |
| FIGURE 519.5B-6. | Ensemble time-varying root mean square estimate. | 9 |
| FIGURE 519.5B-7. | Energy spectral density function estimate. | 10 |
| FIGURE 519.5B-8. | Short time energy spectral density function estimate (data)..... | 10 |
| FIGURE 519.5B-9. | Short time energy spectral density function estimate (residual). | 10 |
| FIGURE 519.5B-10. | Non-stationary model deterministic functions..... | 11 |

MIL-STD-810F
1 January 2000

CONTENTS

| <u>Paragraph</u> | <u>Page</u> |
|---|-------------|
| FIGURE 519.5B-11. Segmented ESD ratio. | 11 |
| FIGURE 519.5B-12. Smoothed simulation root variance estimate for the time-varying mean for simulated ensembles sample sizes of 10, 25, and 50. Sample time histories maximum and median. | 11 |
| FIGURE 519.5B-13. Smoothed simulation root variance estimates for the time-varying standard deviation for simulated ensemble sample sizes of 10, 25, and 50 sample time histories maximum and median $N_p = 10, 25, \text{ and } 50$ | 12 |
| FIGURE 519.5B-14. Smoothed simulation root variance estimate for the time-varying root mean square for simulated ensemble sample sizes of 10, 25 and 50. Sample time histories maximum and median. | 12 |

ANNEX C. REPETITIVE PULSE SHOCK RESPONSE SPECTRUM (SRS)

| | |
|---|----------|
| 1. SCOPE. | 1 |
| 1.1 Purpose..... | 1 |
| 1.2 Application..... | 1 |
| 2. DEVELOPMENT..... | 1 |
| 2.1 Introduction. | 1 |
| 2.1.1 Advantages of this procedure are: | 1 |
| 2.1.2 Disadvantages of this procedure are: | 2 |
| 2.2 Test Configuration..... | 2 |
| 2.3 Creating a Digital File of the Gunfire Materiel Response Vibration..... | 2 |
| 2.4 Computing the Shock Response Spectra..... | 2 |
| 2.5 Estimating Equivalent Half-Cycle Content of Representative Gunfire Materiel Response Pulse..... | 2 |
| 2.6 Generating SRS Transient for Representative Gunfire Materiel Response Pulse. | 2 |
| 2.7 Simulating the Gunfire Materiel Response. | 3 |
| 2.8 Reference/Related Documents..... | 3 |
| 3. RECOMMENDED PROCEDURES. | 3 |
| 3.1 Recommended Procedure..... | 3 |
| 3.2 Uncertainty Factors..... | 3 |

TABLE

| | |
|---|---|
| TABLE 519.5C-I. Amplitude modulated sine wave definition for SRS gunfire materiel response pulse..... | 4 |
|---|---|

FIGURES

| | |
|--|---|
| FIGURE 519.5C-1. Digitized flight data. | 5 |
| FIGURE 519.5C-2. Comparison of representative gunfire pulse using | 5 |
| FIGURE 519.5C-3. SRS gunfire pulse generated using a digital controller..... | 6 |
| FIGURE 519.5C-4. SRS pulse gunfire simulation-analytical pulse concatenation. | 6 |

METHOD 519.5

CONTENTS

| <u>Paragraph</u> | <u>Page</u> |
|---|-------------|
| ANNEX D. HIGH LEVEL RANDOM VIBRATION/SINE-ON-RANDOM VIBRATION/ NARROWBAND RANDOM-ON-RANDOM VIBRATION | |
| 1. SCOPE | 1 |
| 1.1 Purpose..... | 1 |
| 1.2 Application..... | 1 |
| 2. DEVELOPMENT | 1 |
| 2.1 Introduction. | 1 |
| 2.2 Predicting Gunfire Vibration Spectra..... | 2 |
| 2.3 Duration of Test. | 3 |
| 2.4 Spectrum Generation Techniques. | 3 |
| 2.5 Reference/Related Documents..... | 3 |
| 3. RECOMMENDED PROCEDURES | 3 |
| 3.1 Recommended Procedure..... | 3 |
| 3.2 Uncertainty Factors..... | 3 |

TABLES

| | |
|---|---|
| TABLE 519.5D-I. Suggested generalized parametric equations for gunfire-induced vibration..... | 4 |
| TABLE 519.5D-II. Typical gun configurations associated with aircraft classes. | 5 |
| TABLE 519.5D-III. Gun specifications. | 6 |

FIGURES

| | |
|---|----|
| FIGURE 519.5D-1. Generalized gunfire induced vibration spectrum shape. | 7 |
| FIGURE 519.5D-2. The distance parameter (D) and the depth parameter (R_s)..... | 7 |
| FIGURE 519.5D-3. Multiple guns, closely grouped. | 8 |
| FIGURE 519.5D-4. Test level reduction due to gun standoff parameter. | 8 |
| FIGURE 519.5D-5. Test level reduction due to materiel mass loading. | 9 |
| FIGURE 519.5D-6. Test level reduction due to depth parameter. | 9 |
| FIGURE 519.5D-7. Decrease in vibration level with vector distance from gun muzzle. | 10 |
| FIGURE 519.5D-8. Gunfire peak vibration reduction with distance..... | 10 |

MIL-STD-810F
1 January 2000

THIS PAGE INTENTIONALLY BLANK

METHOD 519.5

GUNFIRE VIBRATION

NOTE: Tailoring is essential. Select methods, procedures, and parameter levels based on the tailoring process described in Part One, paragraph 4, and Appendix C. Apply the general guidelines for laboratory test methods described in Part One, paragraph 5 of this standard.

1. SCOPE.

1.1 Purpose.

Gunfire vibration tests are performed to provide a degree of confidence that materiel can physically and functionally withstand the relatively infrequent, repetitive shock or transient vibration encountered in operational environments during the firing of a low caliber gun.

1.2 Application.

Use this method to evaluate the physical and functional performance of materiel likely to be exposed to a gunfire environment in its lifetime. This test method is applicable where materiel is required to demonstrate its adequacy to resist repetitive gunfire environment without unacceptable degradation of its functional performance and/or structural integrity. In general, the gunfire environment may be considered to be a repetitive shock or transient vibration produced by (1) gun muzzle blast pressure impinging on a materiel surface, (2) structure-borne repetitive shock or transient vibration due to actuation of the gun mechanism, and/or a combination of (1) and (2). The closer the materiel surface is to pressure pulse exposure, the more the measured environment appears as a repetitive shock producing high rise time and rapid decay of materiel response, and the less role the structure-borne vibration contributes to the overall materiel response environment. The farther the materiel surface is from the pressure pulse exposure, the more the measured environment appears as a structure-borne repetitive shock or transient vibration that has been filtered by structure intervening between the gun source and the materiel. In general, repetitive shock or transient vibration applied to a complex multi-modal materiel system will cause the materiel to respond to (1) forced frequencies imposed on the materiel from the external excitation environment, and (2) the materiel's resonant natural frequencies either during or immediately after application of the excitation. Such response may cause:

- a. materiel failure as a result of increased or decreased friction between parts, or general interference between parts;
- b. changes in materiel dielectric strength, loss of insulation resistance, variations in magnetic and electrostatic field strength;
- c. materiel electronic circuit card malfunction, electronic circuit card damage, and electronic connector failure. (On occasion, circuit card contaminants having the potential to cause short circuits may be dislodged under materiel response to gunfire environment);
- d. permanent mechanical deformation of the materiel as a result of overstress of materiel structural and non-structural members;
- e. collapse of mechanical elements of the materiel as a result of the ultimate strength of the element being exceeded;
- f. accelerated fatiguing of materials (low cycle fatigue);
- g. potential piezoelectric activity of materials; and
- h. materiel failure as a result of cracks and fracture in crystals, ceramics, epoxies, or glass envelopes.

MIL-STD-810F
1 January 2000

1.3 Limitations.

It may not be possible to replicate some operational service gunfire materiel response environments because of impedance mismatches. In particular, laboratory fixture limitations or other physical constraints may prevent the satisfactory application of the gunfire induced excitation to a test item in the laboratory. In addition:

- a. This method does not include the repetitive shock or transient vibration effects experienced by very large extended materiel, e.g., airframe structural systems, over which varied parts of the materiel may experience different and uncorrelated external excitation. For this type of repetitive shock or transient vibration, specialized tests based on experimental data must be devised.
- b. This method does not include special provisions for performing gunfire vibration tests at high or low temperatures. This includes the extreme temperature environments directly related to the gunfire pressure wave emission and materiel absorption of thermal energy. Perform tests at ambient temperature unless otherwise specified. Guidelines found in this section of the standard, however, may be helpful in setting up and performing gunfire vibration tests at high or low temperatures, but not at gun pressure wave temperatures.
- c. This method is not intended to simulate blast pressure or acoustic effects as a result of exposure to gunfire environment.
- d. This method does not include engineering guidelines related to unplanned test interruption as a result of test equipment or other malfunction. Generally, if interruption occurs during a gunfire vibration test input, repeat that gunfire vibration test input. Care must be taken to ensure stresses induced by the interrupted gunfire vibration test do not invalidate subsequent test results. It is incumbent on all test facilities that data from such interruptions be recorded and analyzed before continuing with the test sequence. In addition, the materiel must be inspected prior to test to ensure pre-gunfire vibration test materiel integrity.

2. TAILORING GUIDANCE.

2.1 Selecting the Gunfire Vibration Method.

After examining requirements documents and applying the tailoring process in Part One of this standard to determine where exposure to a gunfire environment is foreseen in the life cycle of the materiel, use the following to confirm the need for this method and to place it in sequence with other methods.

2.1.1 Effects of a gunfire environment.

Exposure to a gunfire environment has the potential for producing adverse effects on the physical and functional integrity of all materiel. In general, the level of adverse effects increases with the caliber of the gun, proximity of the materiel to the gun, and the duration of the gunfire environment. The gunfire firing rate and the duration of gunfire environment exposure that correspond with natural frequencies of the materiel (along with its subharmonics and superharmonics) will magnify the adverse effects on the materiel's overall physical and functional integrity.

2.1.2 Sequence among other methods.

- a. General. See Part One, paragraph 5.5.
- b. Unique to this method. Sequencing among other methods will depend upon the type of testing i.e., developmental, qualification, endurance, etc. and the general availability of test items. Normally, schedule gunfire vibration tests early in the test sequence, but after any vibration and shock tests.
 - (1) If the gunfire environment is deemed particularly severe and the chances of materiel survival without major structural or functional failure are small, perform the gunfire vibration test first in the test

sequence. This provides the opportunity to redesign the materiel to meet the gunfire vibration requirement before testing to the more benign environments.

- (2) If the gunfire environment is deemed severe but the chances of the materiel survival without structural or functional failure is good, perform the gunfire vibration test after vibration, thermal and shock tests, allowing the stressing of the test item prior to gunfire vibration testing to uncover combined, vibration, temperature shock, and gunfire vibration environmental failures. (There are often advantages to applying gunfire vibration tests before climatic tests, provided this sequence represents realistic service conditions. Climate-sensitive defects often show up more clearly after the application of severe gunfire environments. However, internal or external thermal stresses may permanently weaken materiel resistance to vibration, shock, and gunfire that may go undetected if gunfire vibration tests are applied before climatic tests.)
- (3) In cases in which the gunfire vibration test levels are deemed less severe than the vibration test levels, the gunfire vibration tests may be deleted from the testing sequence.
- (4) The gunfire environment may affect materiel performance when materiel is tested simultaneously to other environmental conditions such as vibration, shock, temperature, humidity, pressure, etc. If materiel is known to be sensitive to a combination of environments, test to those environments simultaneously. If it is impractical to test to a combination of environments simultaneously, and where it is necessary to evaluate the effects of the gunfire environment together with other environments, expose a single test item to all relevant environmental conditions in turn. In general, gunfire may occur at any time during the specified operational conditions, so sequence it as close as practical to the life cycle environmental profile. If in doubt, conduct it immediately after completing any vibration and shock testing.

2.2 Selecting a Procedure.

This method includes a set of three Pulse Procedures and one Vibration Procedure.

a. Pulse Procedures.

- (1) Procedure I: Direct Reproduction of Measured Materiel Response Data.
- (2) Procedure II: Statistically Generated Repetitive Pulse – Mean (Deterministic) Plus Residual (Stochastic) Pulse.
- (3) Procedure III: Repetitive Pulse Shock Response Spectrum (SRS).

b. Vibration Procedure.

Procedure IV: High Level Random Vibration/Sine-on-Random Vibration / Narrowband Random-on-Random Vibration.

2.2.1 Procedure selection considerations.

Based on the test data requirements, determine which test procedure, combination of procedures, or sequence of procedures is applicable. In many cases, one or more of the procedures will apply. Consider all gunfire environments anticipated for the materiel during its life cycle, both in its logistic and operational modes. When selecting procedures, consider:

- a. Materiel response. Materiel response to a substantial gunfire environment is characterized by a high level repetitive shock or transient vibration. Such an environment has principal frequency components at the firing rate of the gun and its harmonics. In addition, there exists comparatively low level random vibration energy distributed at other frequencies from DC to 2 kHz. The gunfire environment is considered to be non-stationary because it usually has a time varying root-mean-square (rms) level that is substantially above the ambient or aircraft-induced environmental vibration level for a short period of time. Because of the nature of the measured response data, the analysis is usually not easily interpreted in terms of either stationary measures of the environment such as autospectral density estimates, or transient measures of the environment in terms of shock response spectra. In this case select one of the

MIL-STD-810F
1 January 2000

Pulse Procedures. Materiel response to a benign gunfire environment is characterized by a slight increase in the ambient vibration level with no readily distinguishable pulse characteristics. Stationary random vibration analysis techniques may be used to specify the test, and Procedure IV may be used. The choice of test procedures is also governed by the in-service gunfire environment and the availability of measured data. It is assumed in applying these procedures that the dynamics of the materiel are well known, in particular, the resonances of the materiel and the relationship of these resonances to the gunfiring rate and its harmonics. Improper test procedure selection may result in either an unconservative materiel undertest or a substantial materiel overtest. These procedures can be expected to cover the entire range of testing related to materiel exposed to gunfire environment. In summary,

- (1) for severe materiel response to gunfire environment with measured data, use Procedures I, II, or III.
 - (2) for benign materiel response to aircraft gunfire with or without measured data use Procedure IV.
- b. The operational purpose of the materiel. From requirement documents, determine the operations or functions to be performed by the materiel before, during, and after exposure to the gunfire environment.
 - c. The natural exposure circumstances. Materiel response to a gunfire environment is heavily dependent upon the caliber of the gun and the physical relationship between the gun and the materiel.
 - d. Data required. The test data required to document the test environment and to verify the performance of the materiel before, during, and after the test.
 - e. Procedure sequence. Refer to paragraph 2.1.2.

2.2.2 Difference among procedures.

- a. Procedure I - Direct Reproduction of Measured Materiel Response Data. In-service gunfire environment materiel response is replicated under laboratory exciter waveform control to achieve a near exact reproduction of the measured gunfire environment materiel response time history. Use the guidelines provided in Annex A.
- b. Procedure II - Statistically Generated Repetitive Pulse – Mean (Deterministic) Plus Residual (Stochastic) Pulse. This procedure is based upon a statistical fitting of a model to in-service response data. Statistical characteristics of the in-service gunfire environment materiel response are modeled (usually by creating a pulse ensemble and obtaining a time varying mean pulse and its associated residuals via nonstationary data processing techniques). The statistical model of the gunfire environment response is replicated under laboratory exciter waveform control to achieve a statistical reproduction of the measured gunfire environment materiel response time history. Use the guidelines provided in Annex B.
- c. Procedure III – Repetitive Pulse Shock Response Spectrum (SRS). The measured in-service gunfire environment materiel response time history is decomposed into individual pulses for analysis. Maximax shock response spectra are computed over the individual pulses to characterize the gunfire environment materiel response by an SRS. A response time history is composed that has a duration equivalent to an individual measured gunfire materiel environment response pulse and that exhibits the characteristic gunfire SRS. The derived gunfire pulse is repeated at the gunfiring rate. Use the guidelines provided in Annex C.
- d. Procedure IV: High Level Random Vibration/Sine-on-Random Vibration/Narrowband Random-on-Random Vibration. If no pulse form is indicated by the measured in-service gunfire environment materiel response time history (in general the firing rate of the gun cannot be determined from an examination of the field measured materiel response time history), or the materiel is distant from the gun and only high level structure-borne random vibration is exhibited, use the guidelines provided for (1) vibration in method 514.5, (2) sine-on-random or narrowband random-on-random vibration, or (3) short duration transient vibration in method 516.5, Procedure VIII. In the absence of measured data, use the guidelines provided in Annex D.

2.3 Determine Test Levels and Conditions.

Having selected this method and relevant procedures (based on the materiel's requirements documents and the tailoring process), complete the tailoring process by identifying appropriate parameter levels, applicable test conditions, and test techniques for the selected procedures. Base these selections on the requirements documents, the Life Cycle Environmental Profile, Operational Environment Documentation (see Part One, figure 1-1), and information provided with this procedure. Consider the following when selecting test levels.

2.3.1 General considerations.

Establish the test severities using available data or data acquired directly from an environmental data measurement program. When these data are not available, test severities and guidance may be found in Annex D. Annex D is to be used for aircraft gunfire vibration only. Test guidance is provided in Annexes A through C for cases in which measurement data are available and a precise replication is desired. The test selected may not necessarily be an adequate simulation of the complete environment; thus, a supporting assessment may be necessary to compliment the test results.

2.3.2 Test conditions.

In all cases care must be taken to replicate the measured environmental materiel response data which may require establishing the correct interface impedances. When measured data is not available, the materiel response must be in accordance with that defined in Procedure IV.

2.3.3 Test axes and number of gunfire events.

The test axes should be in accordance with the physical configuration for the in-service environment. Material response to gunfire pressure pulses will generally involve testing in axes normal to the pressure direction. Material response to structure-borne vibration will generally involve testing in all axes. The number of gunfire events should be in accordance with the Environmental Life-Cycle Profile Document.

2.4 Test Item Configuration.

(See Part One, paragraph 5.8.) Configure the test item for gunfire vibration testing as would be anticipated during in-service use including particular attention to the details of the mounting of the materiel to the platform. Gunfire response vibration can be sensitive to the details of the materiel/platform configuration and input impedances.

2.5 Controls.

The dynamic excitation is controlled to within specified bounds by sampling the dynamic response of the test item at specific locations. These locations may be at or in close proximity to the materiel fixing points (controlled input tests) or at defined points on the materiel (controlled response tests). The dynamic motions may be sampled at a single point or at several locations (multi-point).

- a. For Procedures I, II, and III the electrodynamic or electrohydraulic vibration exciter is operated in an open loop waveform control configuration with materiel response replication at a single point.
- b. For Procedure IV, either single or multi-point control may be used.

2.5.1 Control options.

2.5.1.1 Open loop.

The Pulse Procedures tests are of short duration and performed in an open loop mode after appropriate compensation of the analog voltage input waveform.

MIL-STD-810F
1 January 2000

2.5.1.2 Single point control.

Single point control is a minimum requirement for Procedure IV. Select a single point to represent, as close as possible, the materiel hard point from which the field-measured data were obtained or upon which predictions are based.

2.5.1.3 Multiple point control.

For Procedure IV where the materiel is distant from the gunfire input environment and the measured response data at appropriate hard points indicate no more than a random vibration environment slightly above ambient conditions, multiple point control may be desirable. Multiple point control will be based on the specified control strategy that may include the average of the ASD's of the control points selected.

2.5.2 Control methods.

2.5.2.1 Waveform control.

Application of the techniques for Procedures I, II, and III will generally involve a computer with digital-to-analog interface and analog-to-digital interface with the compensated analog output going directly to drive the exciter. This form of control is termed waveform control where the actual form of the time history (nonstationary or stationary) is preserved in the laboratory replication. Perform signal processing off-line where the resulting properly compensated vibration exciter drive signal will be stored as a digital signal. Certain modern control systems make specific provisions for waveform control.

2.5.2.2 Random vibration control.

Whether the control console is digital or analog, use closed loop control. Because the loop time for the vibration procedure depends on the desired number of degrees of freedom and on the analysis and overall bandwidths, it is important to select these parameters so that test tolerances and control accuracy can be maintained.

3. INFORMATION REQUIRED.

3.1 Pretest.

The following information is required to conduct a gunfire vibration test.

- a. General. Information listed in Part One, paragraphs 5.7, 5.8, 5.9, and 5.11 and Appendix A, Tasks 405 and 406 of this standard.
- b. Specific to this method.
 - (1) Knowledge of the test fixture, test item and combined test fixture/test item modal frequencies, and their relationship to the gunfiring rate. Ideally this would consist of an experimental modal survey related to the test configuration. If this is not practical, a supporting analytical assessment of the modal characteristics of the test configuration needs to be supplied by a trained analyst.
 - (2) Gunfire environment. Either:
 - (a) measured data that are input as a compensated waveform into a exciter system under direct waveform control (Procedure I).
 - (b) measured data that have been statistically processed and a stochastically generated, compensated waveform developed as input into a exciter system under direct waveform control (Procedure II).
 - (c) measured data that have been statistically processed and a complex shock pulse SRS synthesis form of time history generated (superposition of damped sinusoids, amplitude modulated sine waves, or other) and compensated that matches a SRS specifying spectrum shape, peak spectrum values, spectrum break points, pulse duration and gunfiring rate (Procedure III).

- (d) measured high level random or transient vibration (methods 514.5 or 516.5, Procedure VIII), predicted sine-on-random spectrum; or predicted narrowband random-on-random (Procedure IV).
- (3) Techniques used in the processing of the input and the materiel response data.

3.2 During Test.

Collect the following information during conduct of the test:

- a. General. Information in Part One, paragraph 5.10, and in Part One, Appendix A, Tasks 405 and 406 of this standard.
- b. Specific to this method. Information related to failure criteria. Other environmental conditions at which testing is to be carried out if other than standard laboratory conditions, and the specific features of the test assembly (exciter, fixture, interface connections, etc.). For test validation purposes, record achieved test parameters, deviations from pre-test procedures including parameter levels, and any procedural anomalies and any test failures.

3.3 Post-test.

Record the following post-test information.

- a. General. Information listed in Part One, paragraph 5.13, and in Appendix A, Tasks 405 and 406 of this standard.
- b. Specific to this method.
 - (1) Duration of each exposure and number of exposures.
 - (2) Functional and physical integrity of the test item after each test based upon functional testing and visual examination.
 - (3) Response time histories and the information processed from these time histories. In general, under processed information, for
 - (a) Procedure I. Data that correspond to the analysis performed on the measured data. This processing may include an autospectral density (ASD) estimate, an average Fourier spectra (FS) or energy spectral density (ESD) estimate, in cases of very short time history records an SRS estimate or some form of nonstationary processing with a time varying spectra.
 - (b) Procedure II. Data that correspond to the analysis performed on the measured data, which will generally require the creation of an ensemble of short time history (pulse) records. This processing may include an average FS or ESD estimate, an average SRS estimate or some form of nonstationary processing with a time varying spectra over the ensemble of collected data.
 - (c) Procedure III. Data that correspond to the analysis performed on the measured data that will generally require the creation of an ensemble of short time history (pulse) records. Since the input is the repetition of a fixed waveform, the analysis of one input pulse by way of FS, ESD, or SRS will suffice to define the input. For the measured materiel response output, this processing may include an average FS or ESD estimate, an average SRS estimate, or a single SRS estimate computed over several pulses.
 - (d) Procedure IV. Data will be processed to display the frequency spectra defining the event. In general, this will be an ASD estimate over the duration of the event and displayed by the software used to control the exciter.
 - (4) Results of operational checks.
 - (5) Test item and/or fixture modal analysis data.

MIL-STD-810F
1 January 2000

4. TEST PROCESS.

4.1 Test Facility.

Use a test facility, including all auxiliary equipment, capable of providing the specified gunfire materiel response environments within the tolerances stated in paragraph 4.2. In addition, use measurement transducers, data recording and data reduction equipment capable of measuring, recording, analyzing, and displaying data sufficient to document the test and to acquire any additional data required. Unless otherwise specified, perform the specified gunfire vibration tests and take measurements at standard ambient conditions as specified in Part One, paragraph 5.1.

4.2 Controls.

All measurement devices are to be calibrated in accordance with standard calibration procedures. The complete test parameter control chains (checking, compensation, servoing, recording, etc.) should not produce uncertainties exceeding one third of the tolerances specified in paragraphs 4.2.1 through 4.2.4. Because of the nature of the gunfire environment, tolerances may be given in the time, amplitude, and frequency domain according to the processing requirements of the procedure. In Procedures I, II, and III it is assumed that the test item response measurement data collected is representative of the true environment and not a function of the local materiel configuration, e.g., local resonances which may not be controllable to the tolerances in paragraphs 4.2.1 through 4.2.4.¹

4.2.1 Direct reproduction of measured materiel response data.

- a. Time domain. Ensure the duration of one pulse is within 2.5% of the duration obtained from the measured gunfiring rate.
- b. Amplitude domain. Ensure materiel time history major positive and negative response peaks are within $\pm 10\%$ of the measured gunfire time history peaks.
- c. Frequency domain. Compute an average ESD estimate over the ensemble created from the materiel time history response that is within $\pm 3\text{dB}$ of the average ESD estimate computed over the ensemble created from the measured gunfire time history over at least 90% of the frequency range. In cases in which an ensemble from the data cannot be created, compute an ASD estimate of the time history records for comparison provided the data is appropriately windowed to reduce spectral leakage. The tolerances for the ASD analysis are $\pm 3\text{dB}$ over at least 90% of the frequency range.

4.2.2 Statistically generated repetitive pulse – mean (deterministic) plus residual pulse (stochastic).

- a. Time domain. Ensure the duration of one pulse is within 2.5% of the duration obtained from the measured gunfiring rate.
- b. Amplitude domain. Ensure materiel time history major positive and negative response peaks are within $\pm 10\%$ of the measured gunfire time history peaks.
- c. Frequency domain. Compute an average ESD estimate over the ensemble created from the materiel time history response that is within $\pm 3\text{dB}$ of the average ESD estimate computed over the ensemble created from the measured gunfire time history over at least 90% of the frequency range.

4.2.3 Repetitive pulse shock response spectra.

- a. Time domain. Ensure the duration of one pulse is within 5% of the duration obtained from the measured gunfiring rate.

¹ Use text fixturing that will ensure test item response in other axes does not exceed 25% of the test item response in the test axis when measured in the time, amplitude, or frequency domain.

- b. Amplitude domain. Ensure materiel time history major positive and negative response peaks are within $\pm 10\%$ of the measured gunfire time history peaks.
- c. Frequency domain. Ensure the shock response spectrum (SRS) computed over the materiel time history response from one simulated gunfire pulse is within -1dB and $+3\text{dB}$ from the mean SRS computed over the ensemble of field measured gunfire materiel response data over at least 90% of the frequency range. Use an SRS analysis of at least 1/6 octave frequency spacing.

4.2.4 High level random vibration/sine-on-random vibration/narrowband random-on-random vibration.

- a. Time domain. Ensure the root-mean-square (RMS) value of the amplitude measured at the control point in the test axis is within $\pm 5\%$ of the preset RMS value. Likewise, ensure the maximum variation of the RMS value at the fixing points in the test axis is $\pm 10\%$ of the preset RMS value.
- b. Amplitude domain. Ensure the amplitude distribution of the instantaneous values of the random vibration measured at the control point is nominally Gaussian. Use an amplitude distribution that contains all occurrences up to 2.7 standard deviations. Keep occurrences greater than 3.5 standard deviations to a minimum.
- c. Frequency domain. Ensure an ASD analysis of the materiel time history response is within $\pm 3\text{ dB}$ of an ASD analysis computed over the field measured gunfire data or the predicted gunfire environment. Allow local exceedances up to $\pm 6\text{ dB}$ above 500 Hz, but limit the accumulation of all local exceedances to 5% of the overall test frequency range. Use a maximum analysis filter bandwidth of 5 Hz and attempt to have the number of independent statistical degrees of freedom (DOF) for control greater than 100.

4.3 Instrumentation.

In general, acceleration will be the quantity measured to meet specification with care taken to ensure acceleration measurements can be made that provide meaningful data (reference a). Give special consideration to the measurement instrumentation amplitude and frequency range specifications in order to satisfy the measurement and analysis requirements. All measurement instrumentation must be calibrated to traceable national calibration standards (see Part One, paragraph 5.3.2). In addition, instrumentation to measure test item function may be required. In this case, obtain suitable calibration standards and adhere to them.

- a. Accelerometer.
 - (1) Transverse sensitivity of less than or equal to 5%.
 - (2) An amplitude linearity within 10% from 5% to 100% of the peak acceleration amplitude required for testing.
 - (3) For all gunfire vibration procedures, a flat frequency response within $\pm 10\%$ across the frequency range 5 – 2 kHz. The measurement devices may be of the piezoelectric or piezoresistive type.
 - (4) For cases in which response below 2 Hz is desired, piezoresistive accelerometer measurements are required with a flat frequency response within $\pm 10\%$ across the frequency range DC-2 kHz.
 - (5) The measurement device and its mounting will be compatible with the requirements and guidelines provided in reference a.
- b. Other measurement devices. Any other measurement devices used to collect data must be demonstrated to be consistent with the requirements of the test, in particular, the calibration and tolerances provided in paragraph 4.2.
- c. Signal conditioning. Use signal conditioning compatible with the instrumentation requirements on the materiel. In particular, filtering will be consistent with the response time history requirements. Use signal conditioning requirements in accordance with the guidelines provided in reference a. Use extreme care in filtering the acceleration signals at the amplifier output. Do not filter the signal into the amplifier for fear of filtering bad measurement data and the inability to detect the bad measurement data. The signal from the signal conditioning must be anti-alias filtered before digitizing.

MIL-STD-810F
1 January 2000

4.4 Data Analysis.

- a. An analog anti-alias filter configuration will be used that will
 - (1) not alias more than a 5 percent measurement error into the frequency band of interest (1 Hz to 2 kHz).
 - (2) have linear phase-shift characteristics in the data passband.
 - (3) have a passband uniform to within one dB across the frequency band of interest (see paragraph 4.3).
- b. In subsequent processing of the data, use any additional filtering that is compatible with the anti-alias analog filtering. In particular, additional digital filtering must maintain phase linearity for processing gunfire time histories for Procedures I, II, and III.
- c. It is suggested for Procedures I, II and III that the time history data be over-sampled by a factor of 10. Ideally, for 2 kHz data, a sample rate of 20,480 (with a linear phase anti-alias filter set at 2.5 kHz) will be suitable. A maximum 5 Hz analysis filter bandwidth is recommended.
- d. Analysis procedures will be in accordance with those requirements and guidelines provided in reference a.
 - a. In particular the test item response acceleration time histories will be qualified according to the procedures in reference a. In severe cases of response acceleration it may be necessary that each time history be integrated to detect any anomalies in the measurement system e.g., cable breakage, amplifier slewrates exceedance, data clipped, unexplained accelerometer offset, etc. The integrated amplitude time histories will be compared against criteria given in reference a.

4.5 Test Execution.

The following steps, alone or in combination, provide the basis for collecting necessary information concerning the durability and function of a test item in a gunfire environment.

4.5.1 Preparation for test.

4.5.1.1 Preliminary guidelines.

Prior to initiating any testing, review the pretest information in the test plan to determine test details (e.g., procedure, calibration load (if any), test item configuration, measurement configuration, gunfire level, gunfire duration, number of repetitions of gunfire event to be applied). Note in particular all details of the test validation procedures. Use fixturing that simulates actual in-service mounting attachments (including vibration isolators and fastener torque, if appropriate). Install all the connections (cables, pipes, etc.) in a way that they impose stresses and strains on the test item similar to those encountered in service. In certain cases consider the suspension of the test item at low frequency to avoid complex test fixture resonances that may coincide with measured materiel gunfire response resonant frequencies.

4.5.1.2 Pretest checkout.

After appropriate compensation of the excitation input device and prior to conducting the test, perform a pretest checkout of the test item at standard ambient conditions to provide baseline data. Conduct the checkout as follows:

- Step 1. Conduct a complete visual examination of the test item with special attention to stress areas or areas identified as being particularly susceptible to damage and document the results.
- Step 2. Install the test item in its test fixture.
- Step 3. Conduct a test item operational check in accordance with the approved test plan along with simple tests for ensuring the response measurement system is responding properly. Document the results for compliance with information contained in Part One, paragraph 5.
- Step 4. If the test item integrity has been verified, proceed to the first test. If not, resolve the problem and restart at Step 1.

4.5.1.3 Procedure overview.

Paragraphs 4.5.2 through 4.5.5 provide the basis for collecting the necessary information concerning the test item in a gunfire vibration environment. For failure analysis purposes, in addition to the guidance provided in Part One, paragraph 5.14, each procedure contains information to assist in the evaluation of the test results. Analyze any failure of a test item to meet the requirements of the system specifications based on the guidelines in Part One, paragraph 5.14.

4.5.1.4 Test item considerations.

Test items can vary from individual materiel items to structural assemblies containing several items of materiel of different types.

- a. General. Unless otherwise specified in the individual test plan, attach the materiel to the vibration exciter by means of a rigid fixture capable of transmitting the vibration conditions specified. Ensure the fixture inputs vibration to racks, panels, and/or vibration isolators to simulate as accurately as possible the vibration transmitted to the materiel in service. When required, ensure materiel protected from vibration by racks, panels and/or vibration isolators also passes the appropriate test requirements with the test item hard-mounted to the fixture. (Refer to method 514.5 for further guidance relative to field/laboratory impedance mismatches.)
- b. Stores. Where practical, perform testing in three mutually perpendicular axes with the mounting lugs in the normal carriage position. Suspend the store from a structural frame by means of its normal mounting lugs, hooks, and sway braces, that simulate the operational mounting apparatus. Use a test setup such that the rigid body modes (translation and rotation) of vibration for the store/frame/suspension system are between 5 and 20 Hz. Apply compensated materiel response excitation to the store by means of a rod or other suitable mounting device running from a vibration exciter to a hard, structurally supported point on the surface of the store. Alternatively, hard-mount the store directly to the exciter using its normal mounting lugs and a suitable fixture. Ensure the stiffness of the mounting fixture is such that its induced resonant frequencies are as high as possible and do not interfere with the store response. For both configurations, use launcher rails as part of the test setup, where applicable. Refer to method 514.5 for further guidance relative to field/laboratory impedance mismatches.
- c. Subsystem testing. When identified in the test plan, subsystems of the materiel may be tested separately. The subsystems can be subjected to different gunfire levels. In this case, ensure the test plan stipulates the gunfire levels specific to each subsystem.
- d. Test item operation. Refer to the test plan to determine whether the test item is or is not in operation. Because continuous gunfire vibration testing can cause unrealistic damage of the test item (e.g., unrealistic heating of vibration isolators), interrupt the excitations by periods of rest, defined by the test plan. For additional details, refer to Annexes A, B, C, and D.

4.5.2 Procedure I - Direct reproduction of measured materiel response data.

4.5.2.1 Controls.

This procedure assumes that measured materiel response data are available in digital form and this response data will be replicated in the laboratory on the test item.

4.5.2.2 Test tolerances.

Ensure test tolerances are in accordance with those specified in paragraph 4.2.

4.5.2.3 Procedure steps.

- Step 1. Precondition in accordance with paragraphs 4.2 and 4.5.1.
- Step 2. Choose control strategy and control and monitoring points in accordance with paragraph 2.5.

MIL-STD-810F
1 January 2000

- Step 3. Perform operational checks in accordance with paragraph 4.5.1.
- Step 4. Mount the test item on the vibration exciter or utilize some other means of suspension in accordance with paragraph 4.5.1.
- Step 5. Determine the time history representation of the vibration exciter drive signal required to provide the desired gunfire materiel acceleration response on the test item. (Refer to Annex A).
- Step 6. Apply the drive signal as an input voltage and measure the test item acceleration response at the selected control/monitoring point.
- Step 7. Verify that the test item response is within the allowable tolerances specified in paragraph 4.2.1.
- Step 8. Apply gunfire simulation for on and off periods and total test duration in accordance with the test plan. Perform operational and functional checks in accordance with the test plan.
- Step 9. Repeat the previous steps along each of the other specified axes.
- Step 10. In all cases, record the information required.

4.5.2.4 Analysis of results.

Refer to the guidance in Part One, paragraph 5.14, to assist in the evaluation of the test results. In addition, a display of the measured test item response time history and analysis called for in paragraph 4.2.1 to satisfy the test tolerances.

4.5.3 Procedure II - Statistically generated repetitive pulse – mean (deterministic) plus residual (stochastic) pulse.

4.5.3.1 Controls.

This procedure assumes that measured response data is available in digital form, has been statistically modeled, and the generated sample function response data will be replicated in the laboratory on the test item.

4.5.3.2 Test tolerances.

Ensure test tolerances are in accordance with those specified in paragraph 4.2.

4.5.3.3 Procedure steps.

- Step 1. Generate a statistical representation of the field measured materiel response data. In general this will involve an off-line procedure designed to generate an ensemble of pulses based on measured data for input to the vibration exciter (refer to Annex B).
- Step 2. Precondition in accordance with paragraphs 4.2 and 4.5.1.
- Step 3. Choose control strategy and control and monitoring points in accordance with paragraph 2.5.
- Step 4. Perform operational checks in accordance with paragraph 4.5.1.
- Step 5. Mount the test item on the vibration exciter (or use some other means of suspension) in accordance with paragraph 4.5.1.
- Step 6. Determine the time history representation of the vibration exciter drive signal required to provide the desired gunfire materiel acceleration response on the test item. (Refer to Annex B).
- Step 7. Apply the drive signal as an input voltage and measure the test item acceleration response at the selected control/monitoring point.
- Step 8. Verify that the test item response is within the allowable tolerances specified in paragraph 4.2.2.

METHOD 519.5

- Step 9. Apply gunfire simulation for on and off periods and total test duration in accordance with the test plan. Perform operational and functional checks of the test item in accordance with the test plan.
- Step 10. Repeat the previous steps along each of the other specified axes.
- Step 11. In all cases, record the information required.

4.5.3.4 Analysis of results.

Refer to the guidance in Part One, paragraph 5.14, to assist in the evaluation of the test results. In addition, a display of the measured test item response time history and analysis called for in paragraph 4.2.2 to satisfy the test tolerances.

4.5.4 Procedure III – Repetitive pulse shock response spectrum (SRS).

4.5.4.1 Controls.

This procedure assumes that measured response data are available in the digital form of a pulse and an associated SRS. The test pulse is generated as in the case of SRS shock synthesis testing and replicated at the firing rate of the gun.

4.5.4.2 Test tolerances.

Ensure test tolerances are in accordance with those specified in paragraph 4.2.

4.5.4.3 Procedure steps.

- Step 1. Separate the measured field data into individual pulses and compute Shock Response Spectra over the individual pulses using damping factors of 5%, 2%, 1%, and 0.5% ($Q = 10, 25, 50, \text{ and } 100$). (See Annex C.)
- Step 2. Based upon the SRS estimates determined in Step 1, compare the mean shock spectra for each of the damping factors to determine the predominant frequencies and to obtain an estimate of the duration or half cycle content comprising the individual predominant frequencies. An individual selected pulse may be used instead of utilizing the mean SRS for each of the damping factors. (Refer to Annex C.)
- Step 3. Characterize the SRS time history using the results of Step 2 for specification of the complex transient duration, and choose a mean SRS or individual pulse from Step 2 for amplitude characterization.
- Step 4. Precondition in accordance with paragraphs 4.2 and 4.5.1.
- Step 5. Choose control strategy and control and monitoring points in accordance with paragraph 2.5.
- Step 6. Perform operational checks in accordance with paragraph 4.5.1.
- Step 7. Mount the test item on the vibration exciter (or use some other means of suspension) in accordance with paragraph 4.5.1.
- Step 8. After proper vibration exciter drive signal compensation, input the SRS transient through the exciter control system at the firing rate of the gun, and measure the test item acceleration response at the selected control monitoring point.
- Step 9. Verify that the test item response is within the allowable tolerances specified in paragraph 4.2.3.
- Step 10. Apply gunfire simulation on and off periods and total test duration in accordance with the test plan. Perform operational and functional checks of the test item in accordance with the test plan.
- Step 11. Repeat the previous steps along each of the other specified axes.
- Step 12. In all cases, record the information required.

MIL-STD-810F
1 January 2000

4.5.4.4 Analysis of results.

Refer to the guidance in Part One, paragraph 5.14, to assist in the evaluation of the test results. In addition, a display of the measured test item response time history and SRS analysis called for in paragraph 4.2.3 to satisfy the test tolerances.

4.5.5 Procedure IV - High level random vibration/sine-on-random vibration/narrowband random-on-random vibration.

4.5.5.1 Controls.

This procedure assumes that either the gunfire environment is to be predicted or measured response data is available in the form of an ASD estimate. This response data will be replicated in the laboratory by way of vibration control or special software for gunfire vibration testing.

4.5.5.2 Test tolerances.

Ensure test tolerances are in accordance with those specified in paragraph 4.2.

4.5.5.3 Procedure steps.

- Step 1. Compute an autospectral density analysis over the measured gunfire data using an analysis overall bandwidth of at least 2 kHz at a suitable processing analysis bandwidth (not to exceed 5 Hz), or compute a combination discrete sine component and 2 kHz autospectral density prediction (refer to Annex D).
- Step 2. Based upon the guidance to follow, generate time history corresponding to a (1) high level time domain windowed random vibration test spectrum, (2) sine-on-random vibration test spectrum, or (3) narrowband random-on-random vibration test spectrum.
 - a. if the ASD spectral estimate is computed from field measured materiel response data and appears as a continuous spectra with no discrete components at harmonic frequencies then generate a high level random vibration time history having the same spectral content and proceed to generate a transient vibration time history by appropriate time domain windowing with a boxcar shaped window. The window on/off durations being functions of the in-service gunfire schedule.
 - b. if the ASD spectral estimate is computed from field measured materiel response data and appears as a continuous spectra with discrete components at harmonic frequencies then generate either a sine-on-random or narrowband random-on-random vibration time history having the same spectral content according to the knowledge of the in-service use. If the in-service use anticipates a fixed firing rate gun then sine-on-random is the selected test method. If the in-service use anticipates a variable firing rate gun or several guns with fixed firing (or variable firing) rate then the narrowband random-on-random is the selected test method. Selection of the test parameters for narrowband random-on-random (e.g., sweep rate and sweep bandwidth) is left to the discretion of an experienced analyst for specification using the in-service gunfire schedule. The testing should not be limited by the software test capability. The on/off gunfire durations are selected as functions of the in-service gunfire schedule.

NOTE: It is important to realize for any ASD estimate with apparent discrete harmonic components the amplitude of the discrete harmonic components is sensitive to the way in which the stationary random time history is processed. The amplitude of the discrete harmonic components is sensitive to (1) relationship between the "true" discrete frequency (gunfiring rate and harmonics) and the resolution analysis bandwidth selected in the processing and (2) the form of windowing and overlap used in the processing. Make every effort to process the time history data for the combined discrete and continuous spectra estimate for the (1) measured field materiel response and (2) measured laboratory test item response, in exactly the same way.

- c. if the ASD spectral estimate is predicted for materiel response as a continuous spectra with discrete components at harmonic frequencies, then generate either a sine-on-random vibration or narrow band random-on-random time history having the same spectral content according to the knowledge of the in-service use and the experience of an analyst. In general, narrow band random-on-random will be used for gun configurations other than a single gun with a fixed firing rate. The on/off gunfire durations are selected as functions of the in-service gunfire schedule.

Step 3. Precondition the test item in accordance with paragraphs 4.2 and 4.5.1.

Step 4. Choose control strategy and control and monitoring points in accordance with paragraph 2.5.

Step 5. Perform operational checks in accordance with paragraph 4.5.1.

Step 6. Mount the test item on the vibration exciter (or use some other means of suspension) in accordance with paragraph 4.5.1.

Step 7. Input the vibration profile through the exciter control system, and measure the test item acceleration response at the selected control monitoring point or points.

Step 8. Verify that the test item response is within the allowable tolerances specified in paragraph 4.2.4.

Step 9. Apply gunfire simulation on and off periods and total test duration in accordance with the test plan. Perform operational and functional checks of the test item in accordance with the test plan.

Step 10. Repeat the previous steps along each of the other specified axes.

Step 11. In all cases, record the information required.

4.5.5.4 Analysis of results.

Refer to the guidance in Part One, paragraphs 5.14 and 5.17 and Part One, Appendix A, Tasks 405 and 406 to assist in the evaluation of the test results. In addition a display of the measured test item response time history and analysis as called for in paragraph 4.2.4 to satisfy the test tolerances.

5. REFERENCE/RELATED DOCUMENTS.

- a. Handbook for Dynamic Data Acquisition and Analysis, IEST-RP-DTE012.1, Institute of Environmental Sciences and Technology, 940 East Northwest Highway, Mount Prospect, IL 60056.
- b. Harris, C., and C. E. Crede, eds., Shock and Vibration Handbook, 2nd Edition, NY, McGraw-Hill, 1976.
- c. Piersol, A.G., Analysis of Harpoon Missile Structural Response to Aircraft Launches, Landings and Captive Flight and Gunfire. Naval Weapons Center Report #NWC TP 58890. January 1977.
- d. Piersol, Allan G., Determination of Maximum Structural Responses From Predictions or Measurements at Selected Points, Proceedings of the 65th Shock and Vibration Symposium, Volume I, SAVIAC, 1994.
- e. Bendat, J. S. and A. G. Piersol, Random Data: Analysis and Measurement Procedures, John Wiley & Sons Inc., NY, 1986.

MIL-STD-810F
1 January 2000

THIS PAGE INTENTIONALLY BLANK

ANNEX A**DIRECT REPRODUCTION OF MEASURED MATERIEL RESPONSE DATA****1. SCOPE.****1.1 Purpose.**

This Annex provides guidance and a basis for direct reproduction (in a laboratory test) of measured materiel response data on a vibration exciter under waveform control in an open loop mode.

1.2 Application.

This technique is useful for the reproduction of single point materiel response that may be characterized as nonstationary or as a transient vibration (see Part One, Appendix D). Acceleration is considered the variable of measurement in the discussion to follow although other variables could be used, provided the dynamic range of the measured materiel response is consistent with the dynamic range of the electrodynamic exciter used as an input device to reproduce the materiel response.

2. DEVELOPMENT.**2.1 Basic Considerations for Environment Determination.**

It is assumed that an in-service test is performed with properly instrumented materiel where the measurements are made at pre-selected points on the materiel. The measurement points exhibit minimum local resonances, yet the measurement locations will allow the detection of significant overall materiel resonances. The measurement locations may be determined prior to making an in-service test by examination of random vibration data on the materiel using various accelerometer mounting locations and fixturing configurations (the same as those to be used in laboratory testing). In processing, ensure the field measured data is DC coupled (not high pass filtered) and sampled at ten times the highest frequency of interest with appropriate anti-alias filtering techniques. Examine the measured data time history traces for any indication of clipping, or any accelerometer performance anomalies such as zero shifting. If there is indication of accelerometer measurement anomalies, examine a potentially corrupted acceleration time history carefully according to the procedures used in qualifying pyrotechnic shock data, e.g., time history integration to examine velocity and displacement characteristics, sample probability density function (PDF) estimates computed. (For further details refer to method 517 or to reference a. in paragraph 5.) If there are no indications of accelerometer anomalies, high pass filter the in-service measured data at a very low frequency, e.g., 1 Hz, and place it in a digital file for manipulation. An example of gunfire simulation using Procedure I is discussed below. This procedure is performed with a personal computer (PC) with signal processing capability and analog-to-digital and digital-to-analog interfaces.

2.2 Test Configuration.

A specially instrumented test item is installed in a laboratory vibration fixture and mounted on an electrodynamic exciter. The test item employed during the laboratory simulation is the same materiel configuration used to collect the gunfire vibration materiel response data during an in-service test, including accelerometer response measurement locations.

2.3 Creating a Digital File of the Gunfire Vibration Materiel Response.

The first step in the environment replication process is to digitize the measured in-service data to obtain a materiel response amplitude time history (figure 519.5A-1). Digital processing of the analog data is performed using a 2,000 Hz, 48dB/octave linear phase anti-alias filter and a sample rate of 20,480 samples per second for good time history resolution.

MIL-STD-810F
1 January 2000
ANNEX A

2.4 Characterization of Vibration Exciter Drive Signal/Test Item Inverse Frequency Response Function.

Definition of the inverse frequency response function between the exciter drive signal and the acceleration response of the test item installed on the exciter is achieved by subjecting the test item to a low level burst of swept sine excitation. The swept sine excitation is generated on the PC using a sample rate of 20,480 samples per second and a block size of 2,048 points for a duration of approximately 0.1 second. The swept sine input utilizes a start frequency of 10 Hz and a stop frequency of 2,000 Hz. The swept sine excitation is input through the vibration exciter power amplifier using the digital-to-analog interface of the PC. Figure 519.5A-2 presents the swept sine exciter input along with the resulting test item response. Subsequently, the swept sine exciter input and the test item response are digitized using the PC analog-to-digital interface with a sample rate of 20,480 samples per second and a block size of 2,048 points. The inverse frequency response function (IH (f)) is estimated as follows.

$$IH(f) = E_{dd}(f) / E_{dx}(f)$$

where

E_{dd} = the input energy spectral density of the swept sine exciter drive signal, $d(t)$ – units of (volts²-sec)/Hz

E_{dx} = the energy spectral density cross spectrum between the acceleration response of the test item, $x(t)$ and the swept sine exciter drive signal, $d(t)$ – units of (volt-g-sec)/Hz

Figure 519.5A-3 presents the modulus and phase of the inverse frequency response function. To reduce the noise in IH(f) three or more IH(f) estimates may be averaged. Under laboratory conditions, usually the signal-to-noise ratio is so high that averaging to reduce noise levels in the estimate is unnecessary. (See references a and b in paragraph 2.10 below.)

2.5 Tapering the Inverse Frequency Response Function.

Because the signal processing software computes the inverse frequency response function out to the Nyquist frequency, which is far above the frequency range of interest, a tapering function is applied to the inverse frequency response function. The tapering function removes the unwanted frequency content (noise) beyond the frequency band of interest (10 - 2000 Hz). The modulus is reduced to zero from 2,000 Hz over a bandwidth of approximately 200 Hz; whereas, the phase remains constant beyond 2,000 Hz. The modulus and phase of the tapered inverse frequency response function is presented on figure 519.5A-4. Some experimentation with the tapering configuration may be needed at this point on behalf of the tester to optimize the information preserved in the 10 - 2000 Hz frequency domain and reduce excessive noise.

2.6 Computing the Impulse Response Function.

The impulse response function is generated by computing the inverse Fourier transform of the tapered inverse frequency response function, IH(f). See figure 519.5A-5.

2.7 Computing the Compensated Vibration Exciter Drive Signal.

The compensated vibration exciter voltage drive signal is generated by convolution of the impulse response function (figure 519.5A-5) in units of volts/(g-sec) with the measured gunfire materiel response (figure 519.5A-1) in units of (g). This may also be accomplished in the frequency domain by multiplying transforms i.e., IH(f) by the transform of an unwindowed block of time history using either overlap-and-save or overlap and add procedures. The compensated vibration exciter voltage drive signal is plotted in the top portion of figure 519.5A-6.

2.8 Reproducing the Gunfire Materiel Response.

Using the digital-to-analog interface of the PC, the compensated vibration exciter voltage drive signal is input through the vibration exciter power amplifier to obtain the desired gunfire materiel response from the test item. The vibration exciter is under waveform control in an open-loop mode of operation. For the short duration of the nonstationary record or transient vibration, this is an adequate mode of vibration exciter control. Figure 519.5A-6 presents the compensated exciter voltage drive signal along with the resulting materiel response. Figure 519.5A-7

METHOD 519.5

provides a comparison of the overall in-service measured gunfire materiel response with the laboratory simulated gunfire test item response.

2.9 Conclusion.

For single point materiel response measurements on comparatively simple dynamic materiel, the method of direct reproduction of in-service measured materiel response is near "optimal." The main advantage of this technique is that it permits reproduction of materiel responses (nonstationary or transient vibration) that are difficult, if not impossible, to completely specify and synthesize for input to a vibration exciter control system. The main disadvantage of this technique is that there is no obvious way to statistically manipulate the measured materiel response data to ensure a conservative test. However, conservativeness could be introduced into the testing by performing the manipulation at a reduced level of vibration exciter power amplifier gain and then testing at the higher gain. The assumption behind this scenario is that the test item response resulting from the vibration exciter input is a linear function of the power amplifier gain.

2.10 Reference/Related Documents.

- a. Merritt, R.G. and S.R. Hertz, Aspects of Gunfire, Part 1- Analysis, Naval Weapons Center, China Lake, CA 93555-6100, NWC TM 6648, Part 1, October 1990.
- b. Merritt, R.G. and S.R. Hertz, Aspects of Gunfire, Part 2- Simulation, Naval Weapons Center, China Lake, CA 93555-6100, NWC TM 6648, Part 2, September 1990.

3. RECOMMENDED PROCEDURES.

3.1 Recommended Procedure.

For single point materiel response measurements on comparatively simple dynamic materiel, this procedure is to be used in cases in which laboratory replication of the response environment is absolutely essential to establish materiel operational and structural integrity under gunfire environment.

3.2 Uncertainty Factors.

The only significant uncertainty in this procedure results in the degree to which the measured environment differs from the actual in-service environment. It is usually not possible to obtain the measured environment under every conceivable in-service condition.

MIL-STD-810F
1 January 2000
ANNEX A

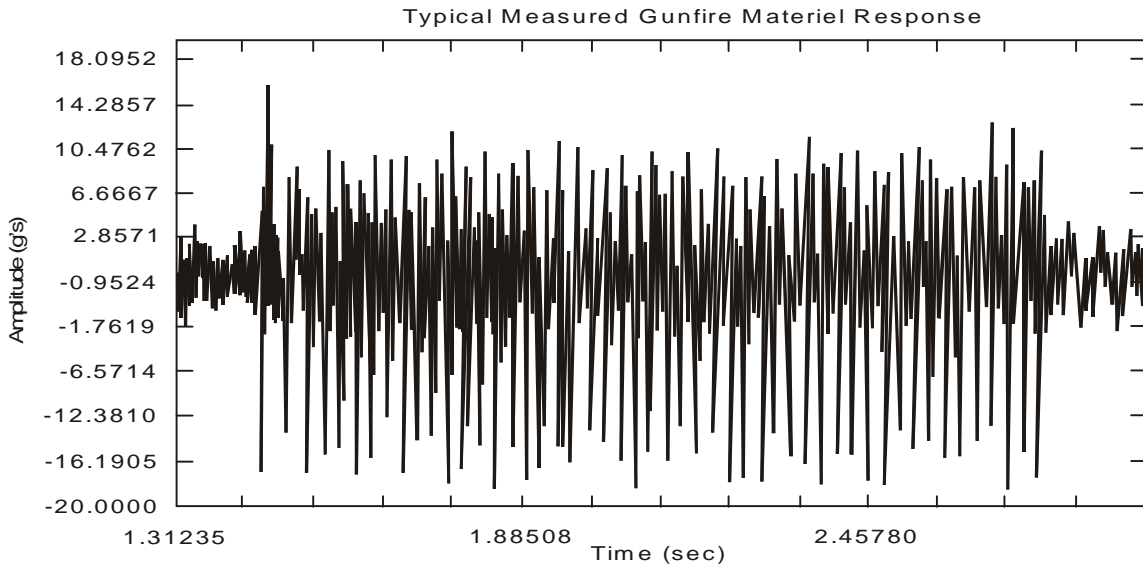

FIGURE 519.5A-1. Digital flight data.

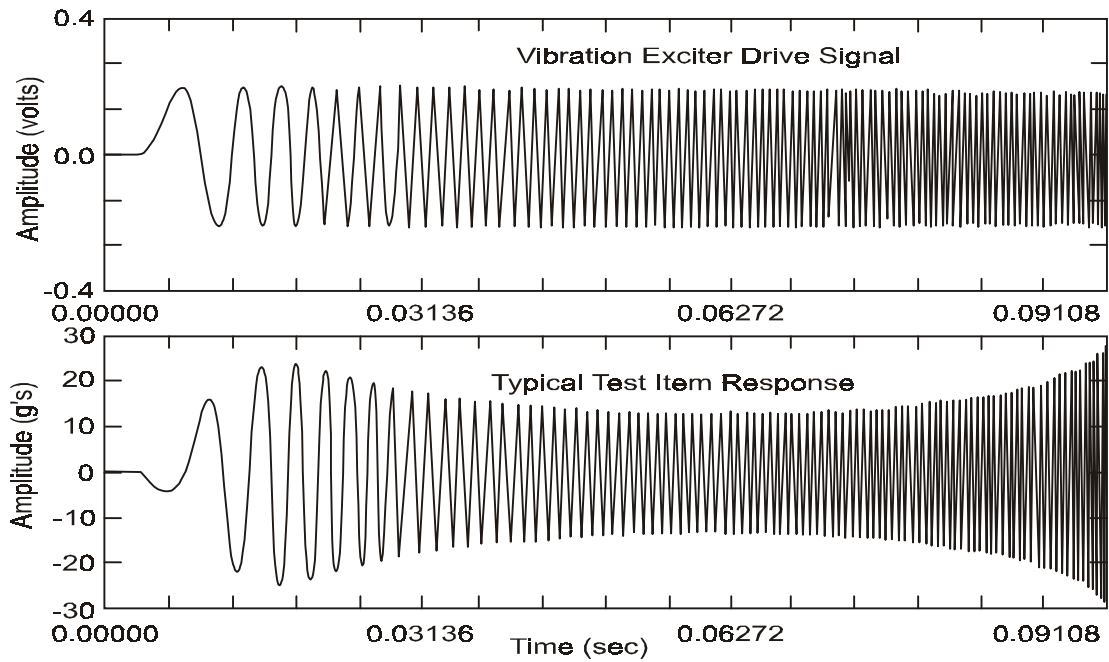
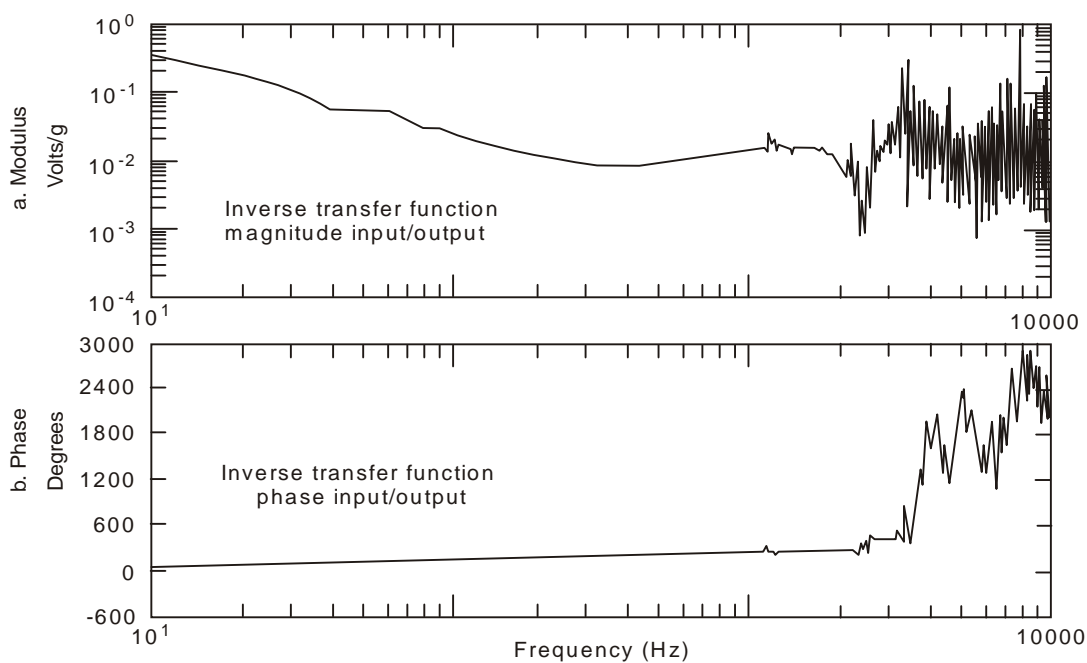
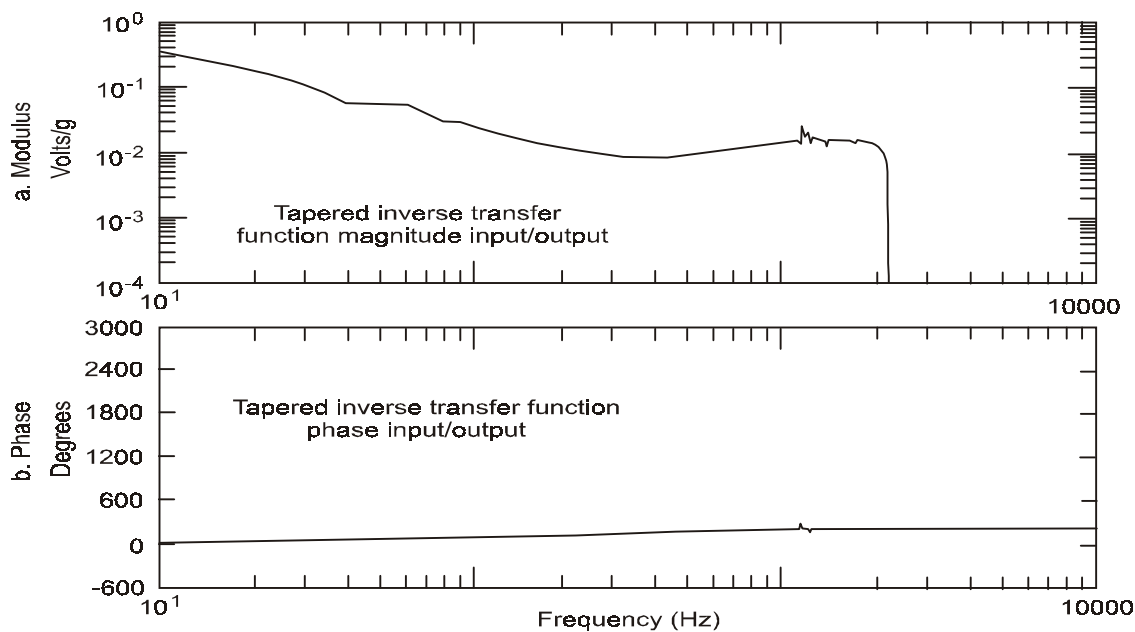

FIGURE 519.5A-2. Swept sine vibration exciter input with resulting test item response.

**FIGURE 519.5A-3. Modulus and phase of inverse frequency response function.****FIGURE 519.5A-4. Modulus and phase of tapered inverse frequency response function.**

MIL-STD-810F
 1 January 2000
 ANNEX A

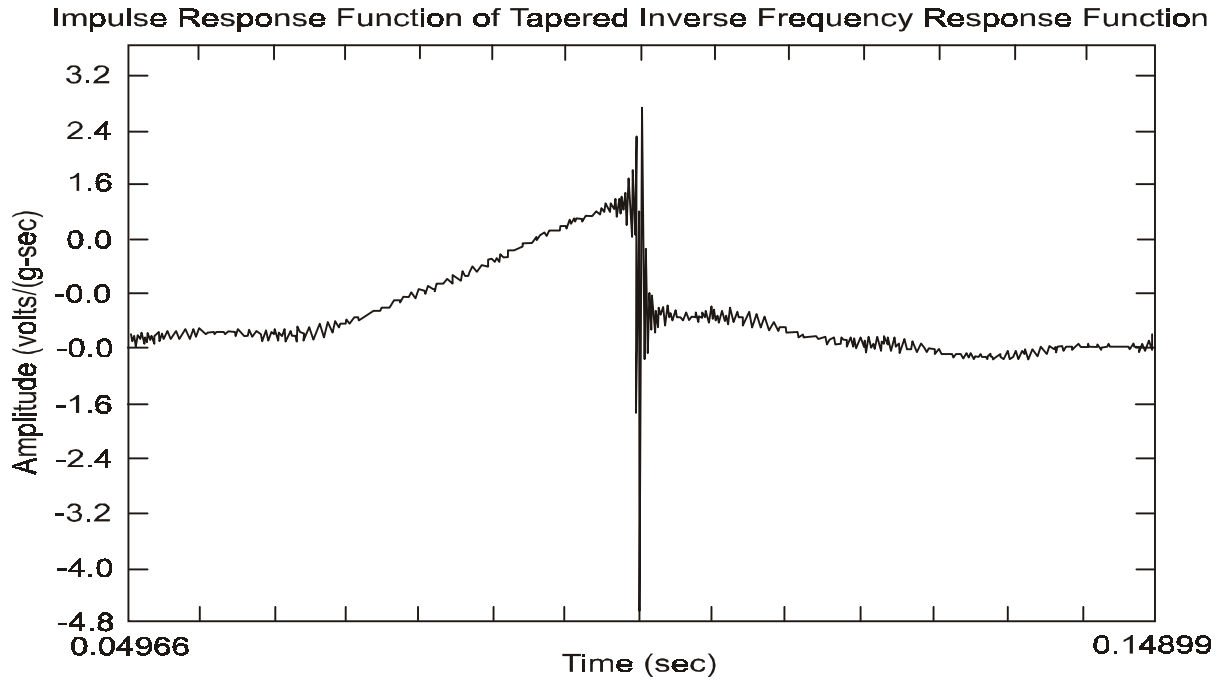

FIGURE 519.5A-5. Impulse response function.

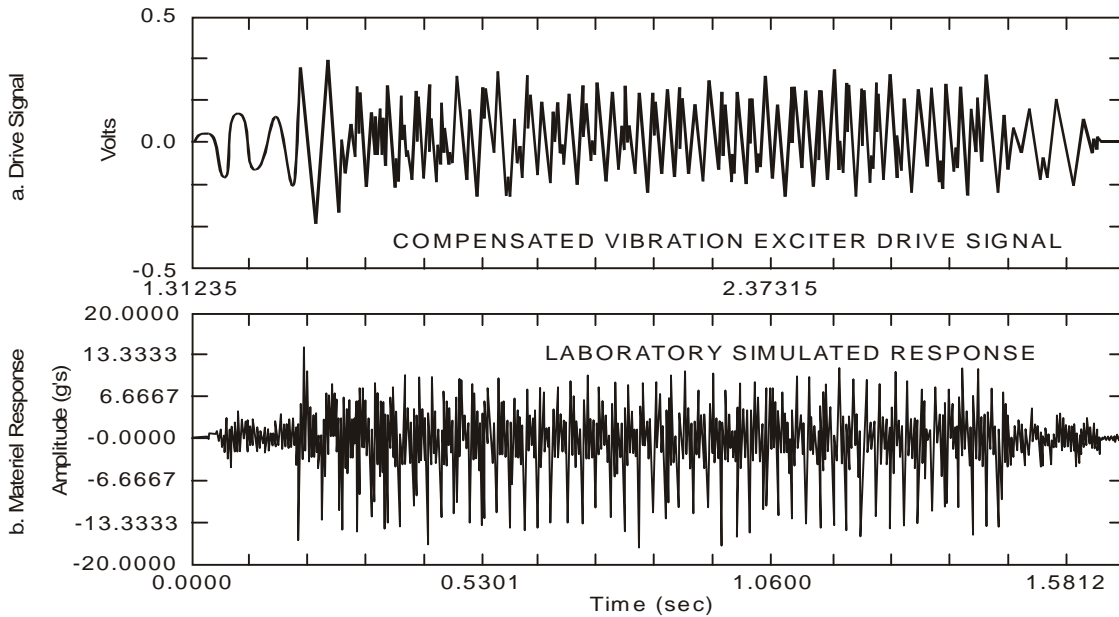

FIGURE 519.5A-6. Compensated vibration exciter drive signal along with resulting test item response.

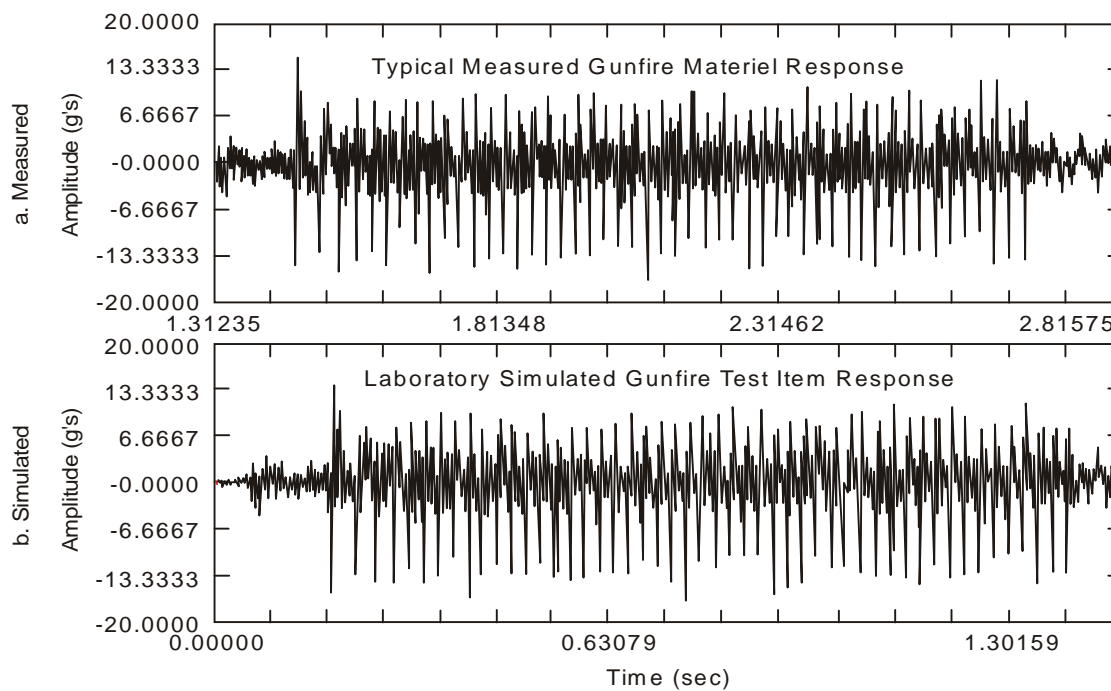

FIGURE 519.5A-7. Comparison of measured gunfire materiel response with laboratory simulated gunfire test item response.

MIL-STD-810F
1 January 2000
ANNEX A

THIS PAGE INTENTIONALLY BLANK

ANNEX B**STATISTICALLY GENERATED REPETITIVE PULSE – MEAN (DETERMINISTIC)
PLUS RESIDUAL (STOCHASTIC) PULSE****1. SCOPE.****1.1 Purpose.**

This annex provides an overview of a technique for simulation of a time-varying random process given a sample function for the process that can be used to generate ensemble statistics describing the time-varying character of the process.

1.2 Application.

Details for the technique are found in reference a, other aspects of the technique are found in references c and d, more recent developments are found in references f, g, and h of this annex. The stochastic simulation technique to be described here is for a single unknown time-varying random process for which a single sample function from the process is available. This single sample function is representative of a single gunfire physical configuration for which extrapolation to other configurations is undetermined. This technique:

- a. is convenient to implement on a personal computer (PC) used to control a vibration exciter system;
- b. has many features analogous to that of traditional stationary time history vibration exciter simulation based on autospectral density estimate specification;
- c. is very flexible in terms of the length of statistically equivalent records it can generate for laboratory test replication of an in-service measured response environment;
- d. has statistics that are easy to interpret and that approximate the true statistical variation in the unknown underlying random process;
- e. can be generalized to other forms of time-varying random processes with ensemble representation easily;
- f. abandons a minimal number of higher order features of the measured response ensemble not considered essential to conservative in-service measured response data replication by way of laboratory test item response simulation testing.

The following paragraphs are directed toward an overview of this method of test item response simulation along with its limitations.

2. DEVELOPMENT.**2.1 Nomenclature for Annex B.**

| | |
|-------------------|--|
| $E []$ | expected value of the quantity within the brackets |
| N, N_p | number of pulses in an ensemble |
| $P(x, t)$ | probability distribution function for a nonstationary random process |
| $R_{xx}(\tau, t)$ | auto-correlation function for a non-stationary random process |
| $\{x_i(t)\}$ | random process |
| $x_i(t)$ | i th sample function for the random process |
| $X_T(f)$ | finite Fourier transform of $x(t)$ over a finite interval of time, T |
| $\mu_x(t)$ | true time-varying mean |

MIL-STD-810F
1 January 2000
ANNEX B

| | |
|---------------------|--|
| $\hat{\mu}_x(t)$ | time-varying mean estimate |
| $\sigma_x(t)$ | true time-varying standard deviation |
| $\hat{\sigma}_x(t)$ | time-varying standard deviation estimate |
| $\Psi_x^2(t)$ | true time-varying mean square |
| $\hat{\Psi}_x^2(t)$ | time-varying mean square estimate |
| T_p | period in seconds of a stationary sample record |
| $f_1=1/T_p$ | fundamental frequency of a stationary sample record in Hertz |
| T | sampling time interval |
| $f_c=1/(2T)$ | Nyquist cutoff frequency |

2.2 Introduction.

In all that follows, the term "ensemble" is taken to mean a collection of sample time history records defined over a specified time interval. In the case of a nonstationary environment, the only complete description of the environment, is given through (1) statistical estimates of all the probabilistic moments of the process as a function of amplitude and time from the specification of $P(x,t)$, or (2) a statistical estimate of the time-varying autocorrelation function, $R(\tau,t)$. Generally, $P(x,t)$ and $R(\tau,t)$ are not available either directly in an analytic form or through accurate estimates based on the limited in-service measured response data. For practical purposes, for an in-service measured environment estimating the (1) time-varying mean, (2) time-varying standard deviation, (3) time-varying root mean square, (4) overall average energy spectral density, and (5) time-varying autocorrelation, assist in characterizing the nonstationary random process from which the sample ensemble is taken. Replication of at least (1) - (4) or all of these measured ensemble estimates in the simulation process will provide a satisfactory nonstationary test simulation of the in-service environment.

2.3 Assumptions.

To assist in deciding if the procedures described in this annex are applicable to particular measurement/test objectives, the following basic assumptions are made. (In what follows it is assumed that acceleration is the materiel response measurement variable. However, other measurement variables, e.g., strain, may be just as useful, provided they are capable of capturing the characteristic amplitude/frequency range of interest.)

- The in-service measured materiel response is obtained from measurements at "hard points" on the materiel to be tested. The term "hard points" implies that (a) local materiel response peculiar to the location of the measurement instrumentation (including structural nonlinearity) is not dominant in the materiel response measurement, and (b) measured materiel response at the selected point is representative of the overall materiel response.
- A sample time history trace of the measured in-service materiel response shows a distinct time-varying quality that repeats in a time interval correlated with the firing rate of the gun.
- A sample time history of the measured in-service materiel response may be decomposed into an ensemble of shorter time history records (or pulses) having similar time-varying characteristics at equal time intervals from the beginning of each of the shorter time history records (the exact method of decomposition of the sample time history record is left to the discretion of the analyst - this usually can be accomplished by examining the measured "timing" or "firing" pulse for a repeated event or by way of cross-correlation methods as applied to the sample time history).
- For testing, configuration information for the test item similar to that configuration for which the measured in-service materiel response data is available.

- e. Use of the procedures outlined in Annex A for Direct Reproduction of Measured Materiel Response Data for determination of the test frequency response function for an electrodynamic or electrohydraulic vibration exciter.
- f. Application of the test frequency response function to the simulated amplitude time history may be accomplished through (a) an energy spectral density function formulation whereby each short time history or pulse is individually compensated by way of the convolution of the pulse time history with the system impulse response function, and the pulses concatenated into one long output voltage time history for input to the digital-to-analog interface, or (b) a long time history convolution, whereby the uncompensated long output time history is first generated and then convolved with the system impulse response function to provide the compensated voltage drive signal for input to the digital-to-analog interface. Both of these techniques assume generation of a long compensated voltage waveform to be run in an open-loop mode on a vibration exciter system. For this open-loop run configuration, it is suggested that the length of the compensated waveform not exceed five seconds and the appropriate abort limits are active on the vibration exciter system. (As sophistication in vibration exciter control systems increases, the energy spectral density formulation with waveform compensation on individual pulses and closed loop control will become the norm for operation. At this time, practicality of this procedure is limited by the speed of processors in input and output to the vibration exciter system. In addition, (1) a rationale for quantitatively judging the “adequacy” of the simulation in “real time,” based on the time-varying statistical estimates, and (2) a means of “real time” compensation of “inadequate” simulation in real time has not been developed.)
- g. The adequacy of the simulation in meeting the specification on the error between the measured in-service materiel response statistics and the measured test item response from the test simulation is based on utilizing equivalent sample sizes or correcting the error measure based on sample size differences.
- h. In summary, at the time of this writing, the test simulation of a measured in-service materiel response is based on
 - (1) pretest generation of the uncompensated test sample time history;
 - (2) compensation of the test sample time history;
 - (3) open-loop waveform control for the vibration exciter system;
 - (4) off line processing of the test item response sample time history for direct comparison with the measured in-service materiel response sample time history.

2.4 Modeling and Statistics for Description of a Materiel Response Time-varying Random Process.

A very general model for modeling time-varying random processes is the “product model,” which assumes that the time-varying characteristics of a random process can be separated from the frequency characteristics of the random process (see reference b). For materiel response to a gunfire environment, a form of product model can be used to adequately describe this response. The procedures used in constructing the model require some experience. Unfortunately, this modeling does not provide for parameterized predictions of materiel response in other measured data configurations. The basic statistics to be used to characterize a measured response environment with an ensemble representation are the following:

- a. the time-varying mean;
- b. time-varying standard deviation;
- c. time-varying root mean square;
- d. average energy spectral density function (may be time dependent).

Error statistics for the simulation may be based on the error expressions for a. through d.

The following is a definition of the product model used in this development. Consideration is given to the time-varying frequency character over discrete time intervals, which can be explored in more detail through the

MIL-STD-810F
1 January 2000
ANNEX B

nonstationary autocorrelation function. References/Related Documents (paragraph 2.7) consider this issue in more detail. Using the notation and terminology from reference b, for $u(t)$ a sample time history from a stationary random process, $\{u(t)\}$, and both $a_1(t)$ and $a_2(t)$ deterministic time histories, then a general time-varying random process, $\{x(t)\}$, can be modeled as

$$x(t) = a_1(t) + [a_2(t) u(t)]_f \quad (\text{B-1})$$

$a_1(t)$ is a deterministic time history defined in terms of the in-service time-varying ensemble mean estimate. $a_2(t)$ is a deterministic time history defined in terms of the in-service time-varying ensemble standard deviation estimate. $a_2(t)$ shapes (in the time domain) the root mean square level of the residuals from the in-service ensemble after $a_1(t)$ has been removed from the in-service ensemble. The "f" following the bracket indicates that the residual information is a function of frequency content and in the description below, f, represents the time-varying frequency content in four discrete equal length time intervals. For this model $a_1(t)$ - the time-varying mean of the ensemble will be referred to as the "signal" and $[a_2(t) u(t)]_f$ - the shaped residual or "noise." If the time-varying random process is heavily dominated by the deterministic time-varying mean or "signal," i.e., the amplitude of $a_1(t)$ is large in comparison with the residual $[a_2(t) u(t)]_f$, then one should expect comparatively small time domain errors in the time-varying mean, standard deviation, and root mean square. The frequency content should also be easily replicated. The residual ensemble constructed by subtracting the time-varying mean from each sample time history of the original ensemble is defined in terms of the in-service measured ensemble as follows:

$$\{r(t)\} = \{x(t)\} - \hat{\mu}_x(t) \quad (\text{B-2})$$

This residual ensemble has the following two properties:

- a. time-varying mean of $\{r(t)\}$ is zero
- b. time-varying root mean square of $\{r(t)\}$ is the time-varying standard deviation of the ensemble $\{x(t)\}$

Time domain criterion for testing the validity of the simulation is given as the variance of the time domain estimators of the time-varying mean, time-varying standard deviation and the time-varying root mean square. Expressions for these estimators and their variance are provided in equations (B-3) through (B-8). The notation and terminology from reference b is employed. The unbiased time-varying mean estimate for an ensemble $\{x(t)\}$ of N time history samples, each of duration T_P , is given by

$$\hat{\mu}_x(t) = \frac{1}{N} \sum_{i=1}^N x_i(t) \quad 0 \leq t \leq T_P \quad (\text{B-3})$$

and the variance of this estimator is given as

$$E\left[\left(\hat{\mu}_x(t) - \mu_x(t)\right)^2\right] \quad 0 \leq t \leq T_P \quad (\text{B-4})$$

where $\mu_x(t)$ is the true nonstationary time-varying mean of the process.

The unbiased time-varying standard deviation estimate for an ensemble $\{x(t)\}$ is given by

$$\hat{\sigma}_x(t) = \sqrt{\frac{\sum_{i=1}^N (x_i(t) - \hat{\mu}_x(t))^2}{N-1}} \quad 0 \leq t \leq T_P \quad (\text{B-5})$$

and the variance of this estimator can be given in its theoretical form as

$$E\left[\left(\hat{\sigma}_x(t) - \sigma_x(t)\right)^2\right] \quad 0 \leq t \leq T_P \quad (\text{B-6})$$

where $\sigma_x(t)$ is the true nonstationary time-varying standard deviation of the process.

The unbiased time-varying mean square estimate for an ensemble $\{x(t)\}$ is given by

$$\hat{\Psi}_x^2(t) = \frac{1}{N} \sum_{i=1}^N x_i^2(t) \quad 0 \leq t \leq T_p \quad (\text{B-7})$$

and the variance of this estimator is given as

$$E \left[\left(\hat{\Psi}_x^2(t) - \Psi_x^2(t) \right)^2 \right] \quad 0 \leq t \leq T_p \quad (\text{B-8})$$

where $\Psi_x^2(t)$ is the true nonstationary time-varying mean square of the process.

In the frequency domain, the average energy spectral density function for an ensemble $\{x(t)\}$

$$\hat{E}_{xx}(f) = 2E \left[\left| X_{T_p}(f) \right|^2 \right] \quad 0 < f < f_c \quad (\text{B-9})$$

and the variance of this estimator is given in theoretical form as

$$V \left[\hat{E}_{xx}(f) \right] = E \left[\left(\hat{E}_{xx}(f) - E_{xx}(f) \right)^2 \right] \quad 0 < f < f_c \quad (\text{B-10})$$

The estimate $\hat{E}_{xx}(f)$ will also contain a bias error related to the Fourier analysis bandwidth. It is assumed here that total bias error can be minimized by proper selection of the Fourier analysis bandwidth. It is important to note that a wider analysis resolution bandwidth was required for demonstration of the time-varying frequency characteristics of the ensemble. The wider analysis resolution bandwidth will increase the bias error. In computing these estimates of error (or just quantitatively measuring how "close" the test simulation test item response is to in-service materiel response) the "true" quantities are unknown but can be taken as the processed in-service measured materiel response.

2.5 Specific Application of the Model to the Measured Materiel Response.

This portion of the annex provides a brief overview of the actual processing necessary to perform a successful stochastic test item response simulation to a measured in-service materiel response environment. Figures in this annex have been graphically enhanced over those contained in reference a. The in-service measured materiel response to be modeled is a fifty pulse ($N_p=50$) round 30 mm gunfire event depicted on figure 519.5B-1a. The gunfiring rate is approximately 40 rounds per second and the event lasts for about 1.25 seconds. This record is digitized at 20,480 samples per second with an anti-alias filter set at 2 kHz. It is clear just from visual inspection of the amplitude time history that it has periodic time-varying characteristics. This record is carefully decomposed into an ensemble of 50 pulses each of about 25 milliseconds length for which ensemble time-varying statistical techniques are applied. Figure 519.5B-2a contains the plot of a typical pulse of the ensemble (pulse 37) and figure 519.5B-3a contains its residual. Figure 519.5B-4a contains a plot of the mean estimate for this ensemble defined in equation (B-3). The standard deviation estimate of the ensemble of N_p records defined in equation (B-5) is shown on figure 519.5B-5a. This is also the root mean square of the residual ensemble. Figure 519.5B-6a contains a plot of the root mean square for the ensemble. By subtracting the mean from each member of the ensemble as described in equation (B-4) a residual ensemble is obtained. This residual ensemble has zero mean and a non-zero time-varying root mean square the same as the standard deviation of the original ensemble. It is very important to understand the characteristics of this residual ensemble. It should be clear from the above figures that the measured ensemble has a time-varying mean, a time-varying mean square, and a time-varying frequency with higher frequencies in the initial portion of the record. An energy spectral density computed on the original measured ensemble and the measured residual ensemble reveals the effect of removal of the time varying mean from the original ensemble and the differing frequency characteristics of the two ensembles. Figure 519.5B-7a provides a superposition of both of these

MIL-STD-810F
1 January 2000
ANNEX B

ESD estimates. The Fourier analysis filter bandwidth for the ESD estimates is 5 Hz. An even more dramatic depiction of the time-frequency character of the original ensemble is given on figure 519.5B-8a, T1 through T4. In this analysis the pulse length is divided into four equal time segments of 6.25 milliseconds each and the average ESD computed for each segment retaining a 20 Hz filter bandwidth. The estimates are averaged over the ensemble with no time domain tapering applied. When all four spectra are superimposed upon one another, it is clear that the variation of frequency with time is substantial both for the original ensemble and for the residual ensemble (figure 519.5B-9a). The residual ensemble is studied for its second order or correlation properties in references a, c and d. The actual steps used to perform the simulation according to the model outlined in equation (B-1) and to estimate the error in the time-varying mean, standard deviation, root mean square, and the residual and overall energy spectrum estimate are contained in reference a. Figures 519.5B-10a and 10b depict the estimated deterministic functions $a_1(t)$ and $a_2(t)$, respectively. Figure 519.5B-11a displays the residual information before the residual is filtered, and figure 519.5B-11b the residual after filtering is applied. Using information from references a and b only, Fourier based processing (FFT and inverse FFT) is used to determine the simulated test ensemble. Segmentation in time in order to simulate the time-varying frequency characteristics of the ensemble did provide for some minor discontinuity at the time interval boundaries in the simulation. From Reference c it can be noted that it is also possible to segment the time-varying characteristics in the frequency domain which also results in some minor discontinuities in the frequency domain. The results of the simulation are displayed on the figures below in order to note the general fidelity in the simulation. Figure 519.5B-1b represents a simulated ensemble with N_p pulses to give an overall qualitative assessment of the simulation. Figure 519.5B-2b and figure 519.5B-3b provide plots of a typical pulse (pulse number 37) and its residual from this simulated ensemble, respectively. Figure 519.5B-4b is the mean for the ensemble with figure 519.5B-5b the standard deviation, and figure 519.5B-6b the root mean square. Figures 519.5B-7 through 519.5B-9 display measured information with corresponding simulated ESD information. Figure 519.5B-12 contains the maximum, the median time-varying root variance estimates for the time-varying mean for sample sizes of 10, 25, and 50 pulses. This represents the error that might be expected at each time point as a result of the simulation for the three sizes of ensembles. Corresponding information is provided on figure 519.5B-13 for the time-varying standard deviation and on figure 519.5B-14 for the time-varying root mean square. In general for an ensemble with $N_p = 50$ sample time histories, the maximum root variance is less than 2.5 g's with the median being, in general, below 0.75 g's.

2.6 Implementation.

The technique outlined above may be implemented by pre-processing the data and generating the simulated materiel response ensemble on a mainframe computer or a PC. In either case the simulated digital waveform must be appropriately compensated by the procedure described in Appendix A before the analog voltage signal to the vibration exciter is output. This technique of stochastic simulation is quite elaborate in detail but does provide for a true stochastic time-varying laboratory simulation of materiel response based on measured in-service materiel response. The technique is flexible, in that it can produce an unlimited number of "pulses," all slightly different, with testing limited only by the length of time a vibration exciter controller can provide an adequate simulation in an open-loop waveform mode of control. If it is assumed that vibration exciter output scales linearly with vibration exciter master gain, degrees of test conservativeness in the stochastic simulation may be introduced.

2.7 References/Related Documents.

- a. R. G. Merritt, Simulation of Ensemble Oriented Nonstationary Processes, Part 2 Proceedings of 1994 IES 40th Annual Technical Meeting, Chicago, IL, May 1994.
- b. J. S. Bendat and A. G. Piersol, Random Data: Analysis and Measurement Procedures, 2nd edition, John Wiley & Sons Inc., New York, 1986.
- c. D. O. Smallwood, Gunfire Characterization and Simulation Using Temporal Moments, Proceedings of the 65th Shock and Vibration Symposium, Volume 1, San Diego, CA, November 1994.
- d. R. G. Merritt, An Example of the Analysis of a Sample Nonstationary Time History, Proceedings of 1994 IES 40th Annual Technical Meeting, Chicago, IL, May 1994.

- e. C. Lanczos, Discourse on Fourier Series, Hafner Publishing Company, New York, 1966.
- f. D. O. Smallwood, Characterization and Simulation of Gunfire with Wavelets, Proceedings of the 69th Shock and Vibration Symposium, Minneapolis, MN, October 1998.
- g. R.G. Merritt, A Note on Prediction of Gunfire Environment using the Pulse Method, Proceedings of 1999 IEST 45th Annual Technical Meeting, Ontario, CA, May 1999.
- h. D. O. Smallwood, Characterization and Simulation of Gunfire with Wavelets, Shock and Vibration, Volume 6, November 2, 1998, IOS Press, The Netherlands.

3. RECOMMENDED PROCEDURES.

3.1 Recommended Procedure.

For single point materiel response measurements on comparatively simple dynamic materiel, use this procedure in cases in which laboratory replication of the response environment with potential statistical variation is absolutely essential to establish materiel operational and structural integrity in a gunfire environment.

3.2 Uncertainty Factors.

This procedure includes statistical uncertainty in addition to uncertainty in the degree to which the measured environment compares with the in-service environment. Uncertainty relative to the variety of in-service environment configurations is not accounted for in this procedure. This procedure cannot be used to determine gunfire environment prediction errors.

MIL-STD-810F
1 January 2000
ANNEX B

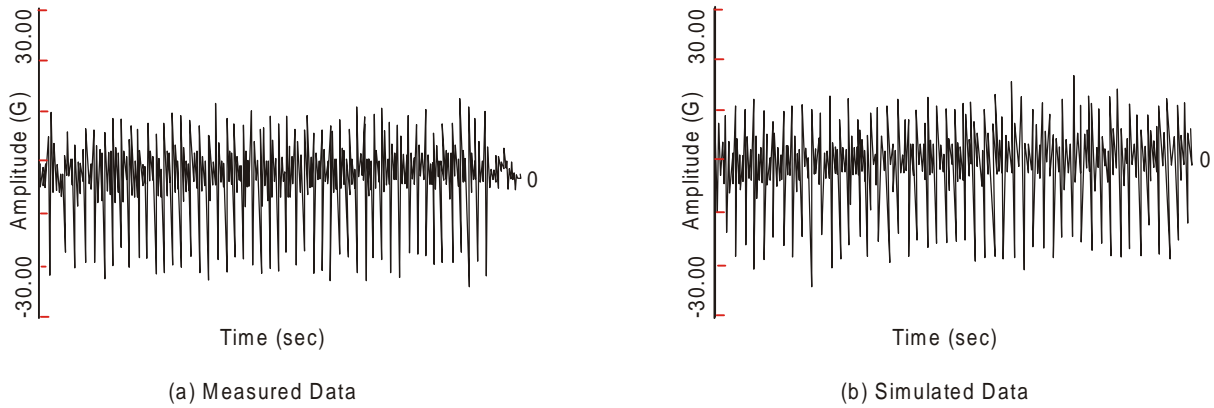

FIGURE 519.5B-1. Fifty round 30mm gunfire event.

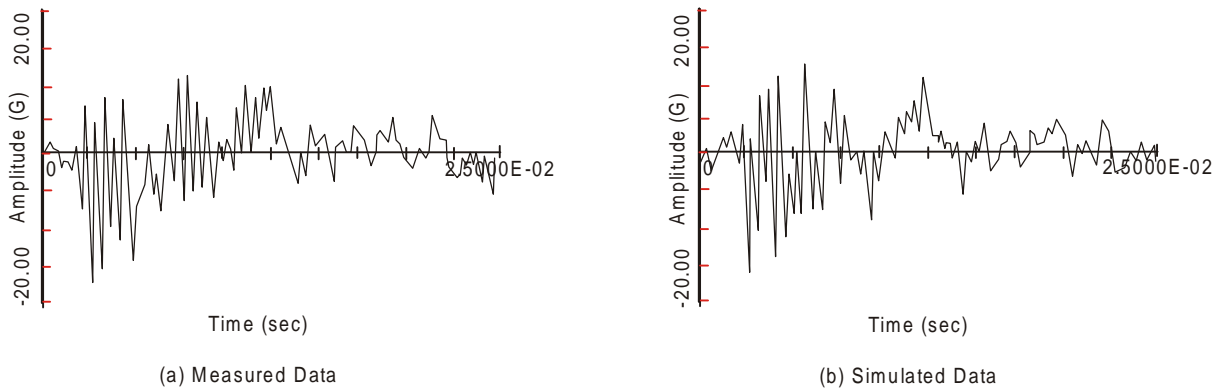

FIGURE 519.5B-2. Ensemble sample time history pulse (pulse 37).

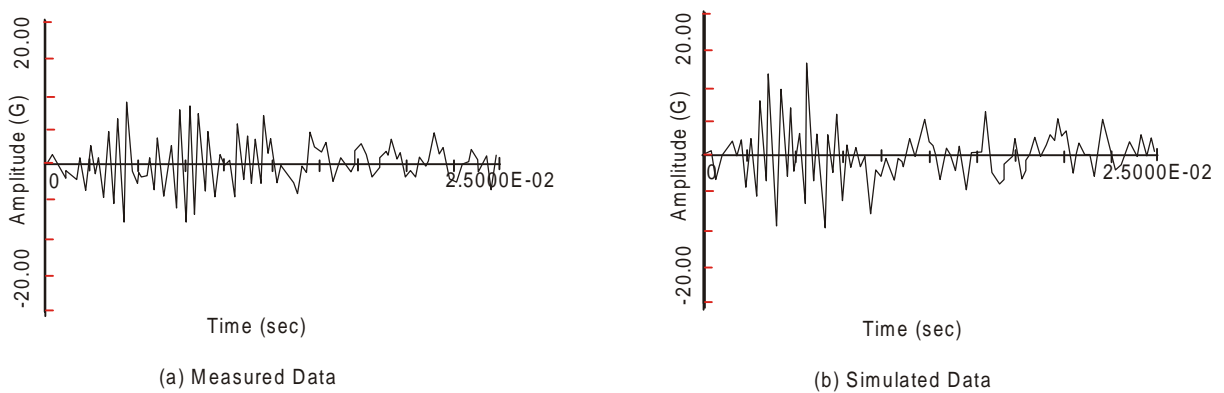
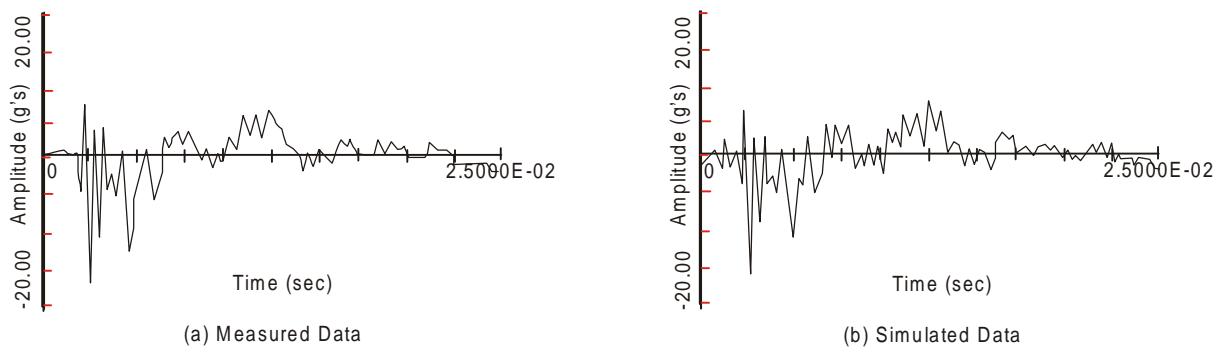
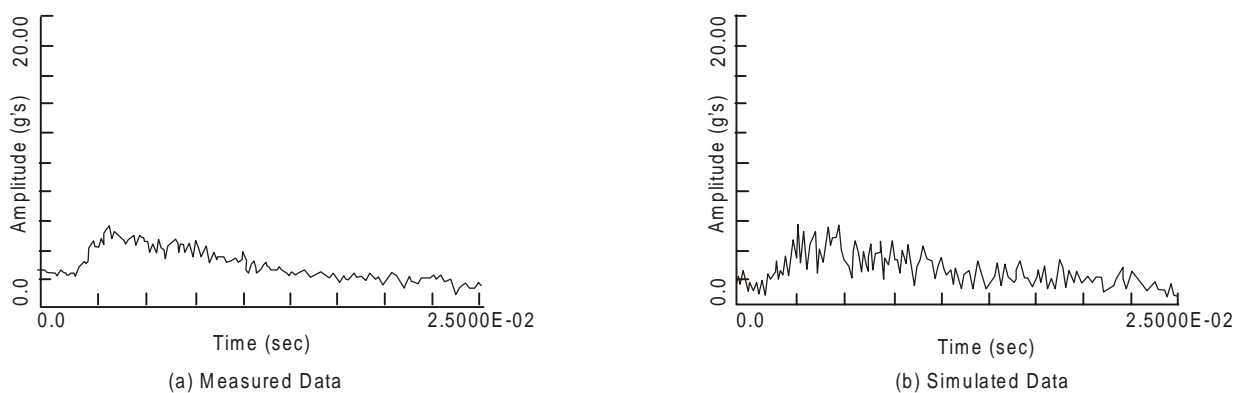
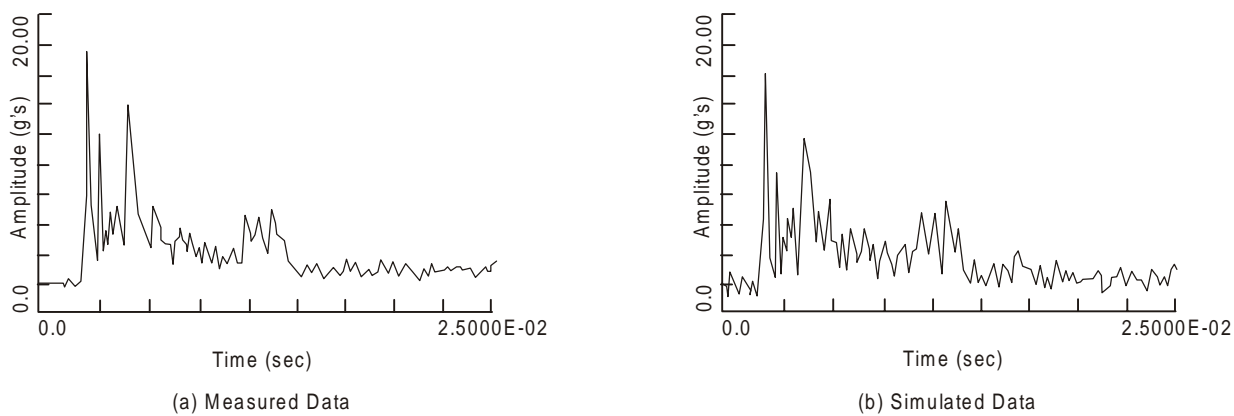

FIGURE 519.5B-3. Ensemble residual sample time history pulse (pulse 37).

**FIGURE 519.5B-4. Ensemble time-varying mean estimate.****FIGURE 519.5B-5. Ensemble time-varying standard deviation estimate.****FIGURE 519.5B-6. Ensemble time-varying root mean square estimate.**

MIL-STD-810F
 1 January 2000
 ANNEX B

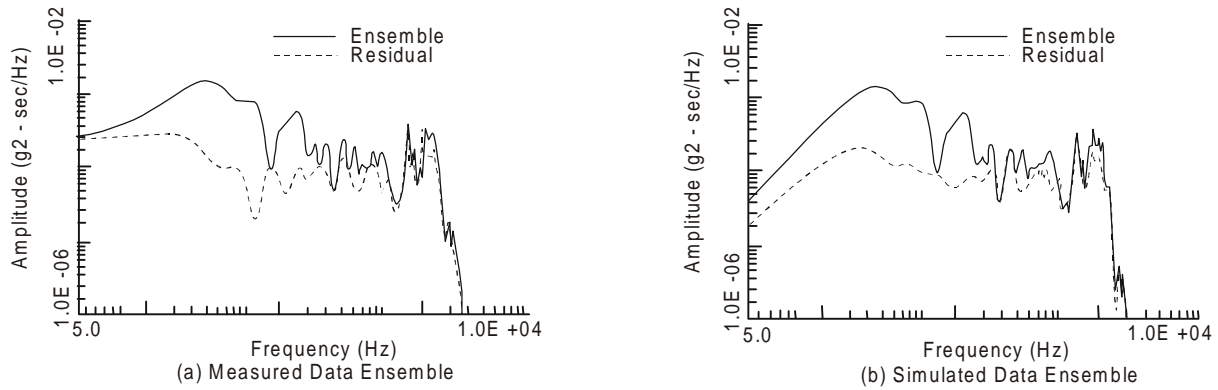

FIGURE 519.5B-7. Energy spectral density function estimate.

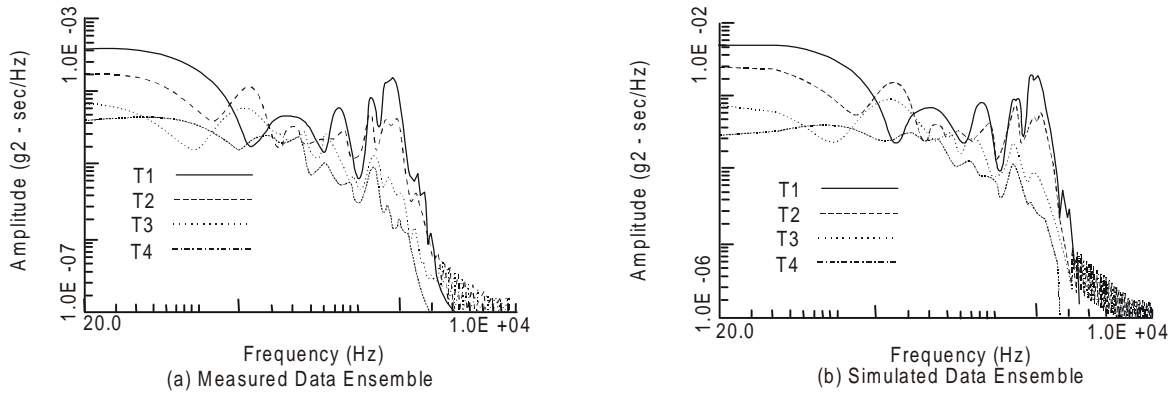

FIGURE 519.5B-8. Short time energy spectral density function estimate (data).

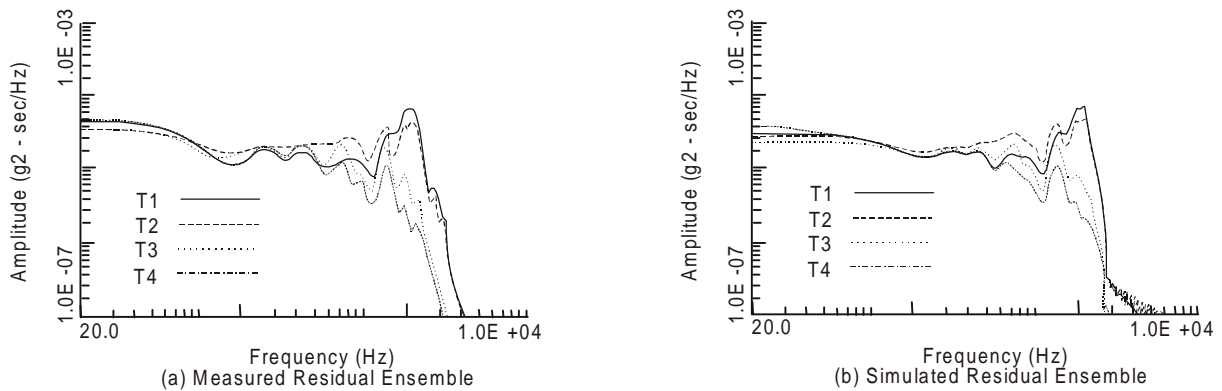

FIGURE 519.5B-9. Short time energy spectral density function estimate (residual).

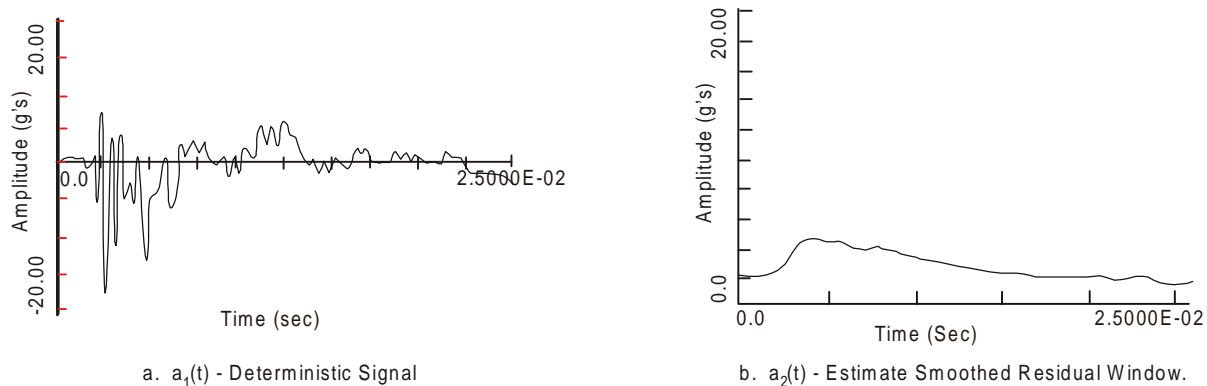

FIGURE 519.5B-10. Non-stationary model deterministic functions.

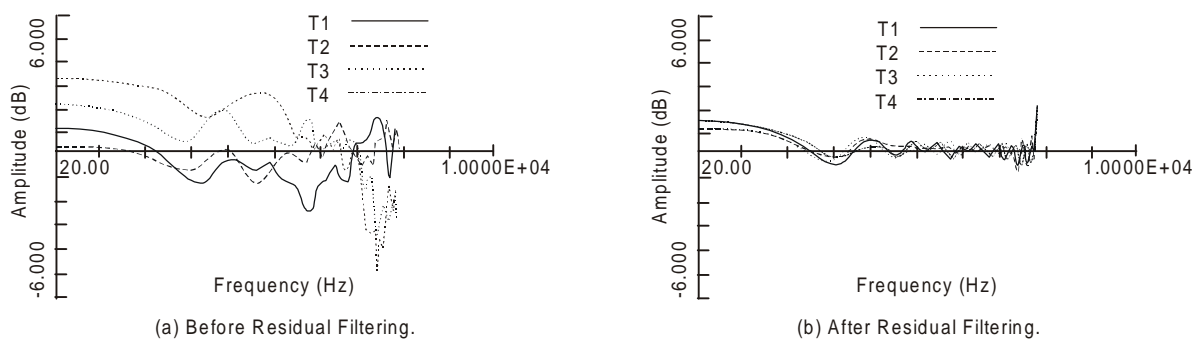

FIGURE 519.5B-11. Segmented ESD ratio.

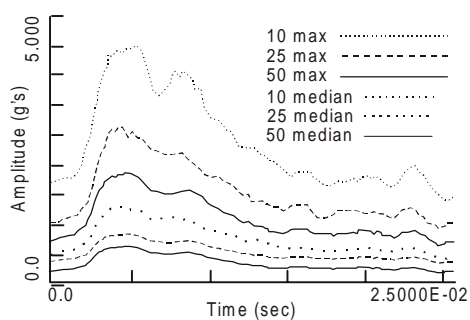

FIGURE 519.5B-12. Smoothed simulation root variance estimate for the time-varying mean for simulated ensembles sample sizes of 10, 25, and 50. Sample time histories maximum and median.

MIL-STD-810F
1 January 2000
ANNEX B

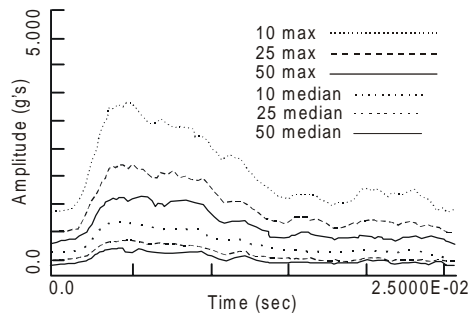

FIGURE 519.5B-13. Smoothed simulation root variance estimates for the time-varying standard deviation for simulated ensemble sample sizes of 10, 25, and 50 sample time histories maximum and median $N_p = 10, 25,$ and $50.$

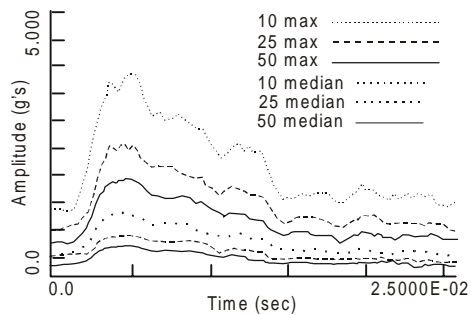

FIGURE 519.5B-14. Smoothed simulation root variance estimate for the time-varying root mean square for simulated ensemble sample sizes of 10, 25 and 50. Sample time histories maximum and median.

ANNEX C

REPETITIVE PULSE SHOCK RESPONSE SPECTRUM (SRS)

1. SCOPE.

1.1 Purpose.

This annex provides guidance and a basis for a technique for laboratory simulation of a measured materiel response of a gunfire environment. This technique is a form of the "Pulse Method" previously identified in MIL-STD-810E.

1.2 Application.

This technique is for a single unknown time-varying random process for which a single sample function from the process is available. This single sample function is representative of a single gunfire physical configuration for which extrapolation to other configurations is undetermined. This technique:

- a. is convenient to implement on a vibration exciter control system with SRS capability;
- b. has many features analogous to that of traditional SRS shock simulation based on SRS estimate specification;
- c. is very flexible in terms of the length of statistically equivalent records it can generate for laboratory test replication of an in-service measured response environment;
- d. is not restricted to one form of pulse, and
- e. abandons a minimal number of higher order features of the measured response ensemble not considered essential to conservative in-service measured response data replication by way of laboratory test item response simulation testing.

The following paragraphs are directed toward an overview of this method of test item response simulation along with its limitations.

2. DEVELOPMENT.

2.1 Introduction.

The SRS method assumes that the measured materiel response time history can be decomposed into an ensemble of individual pulses. Maximax SRS are computed over the ensemble of pulses using various damping factors to assist in characterizing the frequency content of the individual pulses. The SRS mean is also computed over the ensemble of pulses for each damping factor to further characterize the materiel response pulses. Using the information from the SRS, an acceleration time history using amplitude modulated sine components or damped sinusoids is synthesized. The SRS time history is then used as the characteristic gunfire materiel response pulse, and input to the test item at the firing rate of the gun. (See references a and b in paragraph 2.8.)

2.1.1 Advantages of this procedure are:

- a. it makes use of standard laboratory shock test equipment;
- b. the method reproduces the frequency characteristics of the measured materiel response data;
- c. the SRS can be easily specified in documents and reproduced at various test facilities.

MIL-STD-810F
1 January 2000
ANNEX C

2.1.2 Disadvantages of this procedure are:

- a. the character of the time history generated by the amplitude-modulated sine components or damped sinusoids is not well controlled and may not appear similar in form to the measured materiel response pulses;
- b. little or no statistical variation can be easily introduced into the simulation;
- c. reproducing the series of pulses at the firing rate of the gun may also present a problem for vibration exciter control systems not designed for this mode of operation.

A particular example of gunfire materiel response simulation using the Repetitive Pulse Shock Response Spectrum (SRS) technique is discussed below. This procedure, described in the following paragraphs, was performed using a digital vibration control system with SRS testing capability. (See reference b in paragraph 2.8.)

2.2 Test Configuration.

An instrumented test item is installed in a laboratory vibration fixture and mounted to the armature of an electrodynamic vibration exciter. The test item employed during the laboratory simulation is of the same configuration as the materiel used to measure the materiel response data. A piezoelectric accelerometer is installed internal to the test item for purposes of acceleration response measurement.

2.3 Creating a Digital File of the Gunfire Environment Materiel Response Vibration.

The first step in this simulation process is to digitize the measured in-service materiel response data to obtain an acceleration time history (figure 519.5C-1). Digital processing of the analog data is performed using a 2 kHz, 48 dB/octave low pass linear phase anti-alias filter (digital file was DC coupled and not high pass filtered) and a sample rate of 20,480 samples per second for good time history resolution.

2.4 Computing the Shock Response Spectra.

If examination of the individual measured response pulses indicates similar character between the pulses, a representative pulse is chosen for analysis. SRS are then computed over the representative pulse using a specified analysis Q of 10, 25, 50, and 100. To increase the statistical confidence in the results the pulse sequence may be ensemble averaged in time, the "mean" of the ensemble taken as the representative pulse, and the procedure above applied. If pulse characteristics are very dissimilar, then it may be necessary to run several tests from an analysis depending upon the judgement of an experienced analyst.

2.5 Estimating Equivalent Half-Cycle Content of Representative Gunfire Environment Materiel Response Pulse.

Figure 519.5C-2 indicates that the representative gunfire environment materiel response pulse contains seven predominant frequencies at near 80, 280, 440, 600, 760, 1,360, and 1,800 Hz. Because (2Q) half-cycles for a constant amplitude sine wave provides approximately 95% of the maximum amplitude given Q, an estimate of the equivalent half-cycle content that makes up the predominant frequencies contained in the measured gunfire materiel response can be determined by identifying the Q at which the peak acceleration for a particular frequency of the SRS begins to level off. A Q of 10 on figure 519.5C-2 characterizes the half-cycle content of the 80 Hz component. The half-cycle content of the other predominant frequencies, except at 1,800 Hz, is represented by a Q of 25. A Q of 50 quantifies the half-cycle content of the 1,800 Hz component.

2.6 Generating SRS Transient for Representative Gunfire Environment Materiel Response Pulse.

After estimating the frequency content of the representative gunfire environment materiel response pulse, an SRS transient time history pulse is generated (from a proprietary wave synthesis algorithm) using a digital vibration exciter control system. The SRS transient time history pulse is composed of 1/12-octave amplitude-modulated sine components, with the majority of the 1/12-octave components limited to three half-cycles that is the minimum allowed for the exciter control system. The seven predominant frequencies are restricted for half-cycle content by

either the 25-millisecond duration of the gunfire response pulse (40 Hz gunfiring rate) or by the half-cycle estimation technique discussed in Annex C, paragraph 2.5. A Q of 10 is identified for the 80-Hz component; a Q of 25 for the 280-, 440-, 600-, 760-, and 1,360-Hz components; and a Q of 50 for the 1,800 Hz component. The SRS mean is computed over the ensemble of pulses for each damping factor (Q= 10, 25, 50, and 100) to characterize the SRS amplitudes. The mean SRS that is computed using an analysis Q of 50 is then selected to define the SRS amplitude for each frequency component of the simulated materiel response pulse. Zero time delay is specified for each of the 1/12-octave amplitude modulated sine components. See table 519.5C-I for the definition and figure 519.5C-3 for the SRS gunfire materiel response transient produced by the amplitude modulated sine component definition.

2.7 Simulating the Gunfire Materiel Response.

The final step in the gunfire materiel response simulation is to repeat the SRS response transient at the gunfiring rate of 40 Hz. Because of output pulse rate limitations of the vibration exciter control system being used, the 40 Hz firing rate could not be achieved. Figure 519.5C-4 is an acceleration time history that illustrates the repetitive character of the SRS gunfire environment simulation method without vibration exciter controller output pulse rate limitations. Note: Figure 519.5C-4 is generated for illustrative purposes by digitally appending the figure 519.5C-3 SRS materiel response transient pulse at the gunfiring rate. If the vibration exciter control system does not allow for such rapid repetition, the waveform control procedure defined in Annex A could be used on a digitally simulated and vibration exciter compensated series of materiel response pulses.

2.8 Reference/Related Documents.

- a. Merritt, R.G. and S.R. Hertz, Aspects of Gunfire, Part 1- Analysis, Naval Weapons Center, China Lake, CA 93555-6100, NWC TM 6648, Part 1, October 1990.
- b. Merritt, R.G. and S.R. Hertz, Aspects of Gunfire, Part 2- Simulation, Naval Weapons Center, China Lake, CA 93555-6100, NWC TM 6648, Part 2, September 1990.

3. RECOMMENDED PROCEDURES.

3.1 Recommended Procedure.

For single point materiel response measurements on comparatively simple dynamic materiel, use this procedure. This procedure is to be used in cases in which laboratory replication of the response environment is essential to establish materiel operational and structural integrity under gunfire environment.

3.2 Uncertainty Factors.

This procedure includes no statistical uncertainty in addition to no uncertainty in the degree to which the measured environment compares with the in-service environment.

MIL-STD-810F
1 January 2000
ANNEX C

TABLE 519.5C-I. Amplitude modulated sine wave definition for SRS gunfire materiel response pulse.¹

| Frequency (Hz) | Amplitude (g's) | Half-cycles | Frequency (Hz) | Amplitude (g's) | Half-cycles |
|----------------|-----------------|-------------|----------------|-----------------|-------------|
| 78.75 | 11.995 | 3 | 445.45 | 34.995 | 21 |
| 83.43 | 11.803 | 3 | 471.94 | 26.455 | 3 |
| 88.39 | 11.628 | 3 | 500.00 | 19.999 | 3 |
| 93.64 | 11.455 | 3 | 529.73 | 21.232 | 3 |
| 99.21 | 11.285 | 3 | 561.23 | 22.568 | 3 |
| 105.11 | 11.117 | 3 | 594.60 | 23.988 | 29 |
| 111.36 | 10.952 | 3 | 629.96 | 18.323 | 3 |
| 117.98 | 10.777 | 3 | 667.42 | 13.996 | 3 |
| 125.00 | 10.617 | 3 | 707.11 | 20.448 | 3 |
| 132.43 | 10.459 | 3 | 749.15 | 29.992 | 37 |
| 140.31 | 10.304 | 3 | 793.70 | 31.225 | 3 |
| 148.65 | 10.151 | 3 | 840.90 | 32.509 | 3 |
| 157.49 | 10.000 | 3 | 890.90 | 33.845 | 3 |
| 166.86 | 10.814 | 3 | 943.87 | 35.237 | 3 |
| 176.78 | 11.708 | 3 | 1,000.00 | 36.728 | 3 |
| 187.29 | 12.662 | 3 | 1,059.46 | 38.238 | 3 |
| 198.43 | 13.709 | 3 | 1,122.46 | 39.811 | 3 |
| 210.22 | 14.825 | 3 | 1,189.21 | 41.448 | 3 |
| 222.72 | 16.051 | 3 | 1,259.91 | 43.152 | 3 |
| 235.97 | 17.358 | 3 | 1,334.84 | 44.975 | 49 |
| 250.00 | 18.793 | 3 | 1,414.21 | 37.325 | 3 |
| 264.87 | 20.324 | 3 | 1,498.31 | 31.010 | 3 |
| 280.62 | 22.004 | 13 | 1,587.40 | 50.003 | 3 |
| 297.30 | 18.275 | 3 | 1,681.79 | 80.631 | 3 |
| 314.98 | 16.901 | 3 | 1,781.80 | 130.017 | 89 |
| 333.71 | 14.825 | 3 | | 124.882 | |
| 353.55 | 13.002 | 3 | 1,887.75 | 119.950 | 3 |
| 374.58 | 16.653 | 3 | 2,000.00 | | 3 |
| 396.85 | 21.330 | 3 | | | |
| 420.45 | 27.321 | 3 | | | |

¹ Definition is based on the form in proprietary software (see reference b).

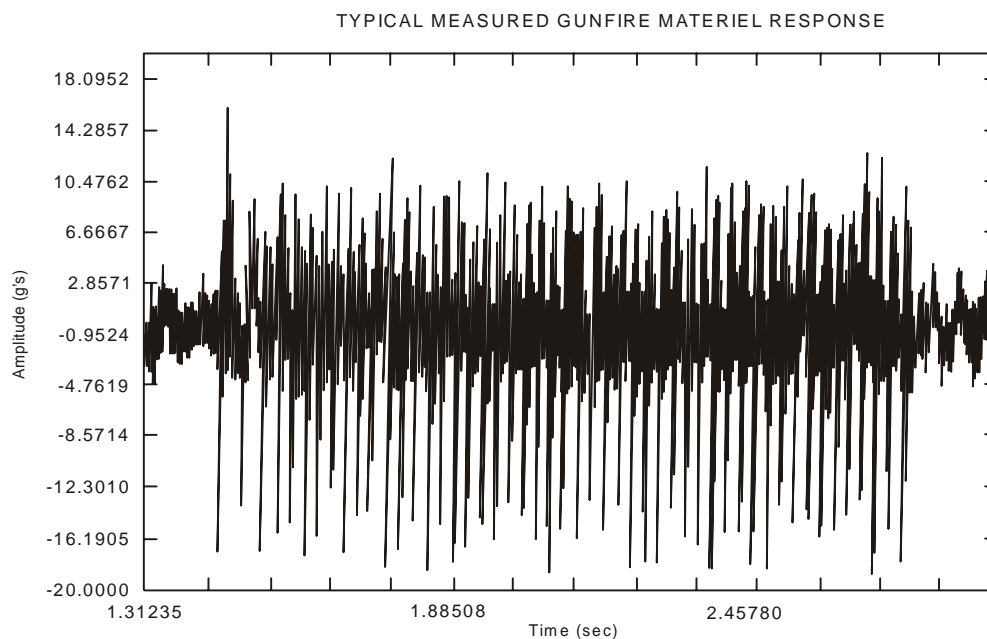

FIGURE 519.5C-1. Digitized flight data.

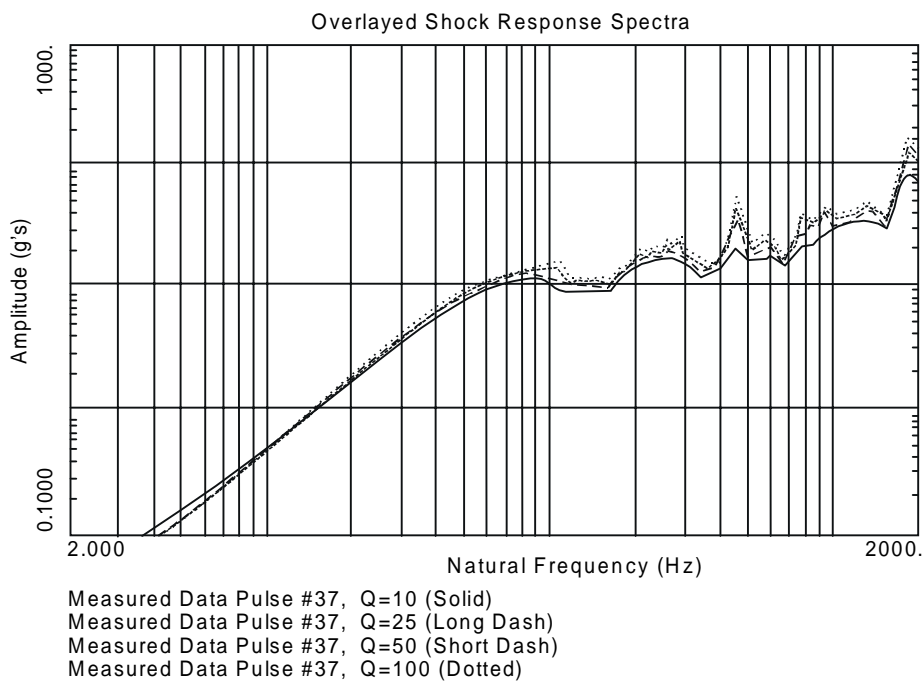

FIGURE 519.5C-2. Comparison of representative gunfire pulse using a Q of 10, 25, 50 and 100.

MIL-STD-810F
1 January 2000
ANNEX C

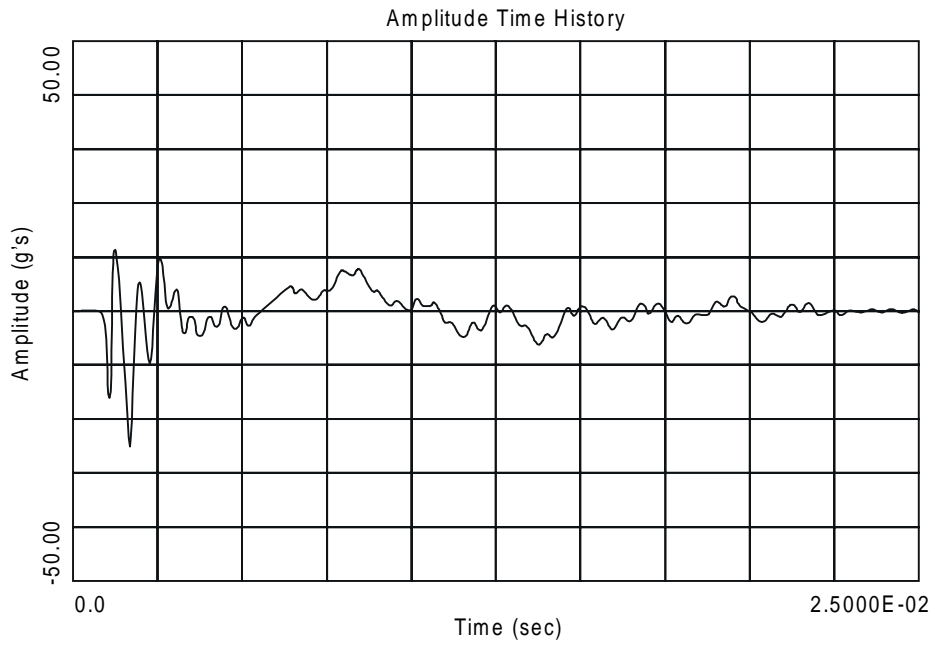

FIGURE 519.5C-3. SRS gunfire pulse generated using a digital controller.

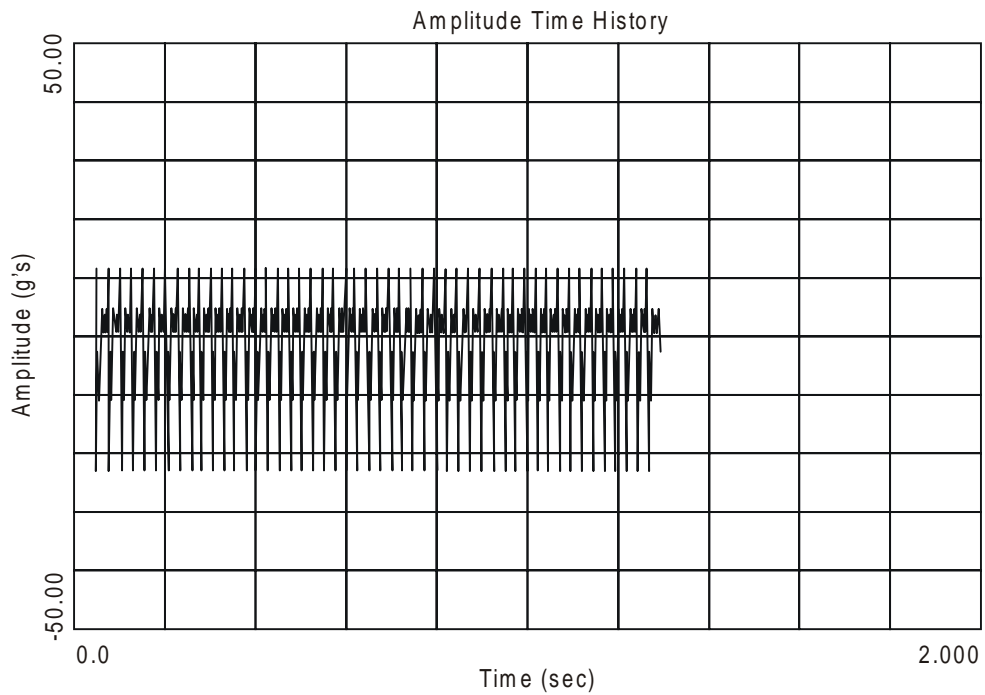

FIGURE 519.5C-4. SRS pulse gunfire simulation-analytical pulse concatenation.

ANNEX D**HIGH LEVEL RANDOM VIBRATION/SINE-ON-RANDOM VIBRATION/
NARROWBAND RANDOM-ON-RANDOM VIBRATION****1. SCOPE.****1.1 Purpose.**

This Annex provides the option of utilizing predicted gunfire vibration data (when measured data is not available), to ensure that materiel mounted in an aircraft with onboard guns can withstand the vibration levels caused by (1) pulse overpressures emitting from the muzzle of the gun impinging upon materiel support structure, and (2) structure-borne vibration. (This Annex constitutes a reformatting of method 519.4, Gunfire Vibration, Aircraft, in MIL-STD-810E with a limited number of enhancements.) This Annex also provides the option for using high level random vibration (measured data are available) when the measured data spectrum displays no outstanding discrete harmonic components.

1.2 Application.

This Annex is applicable only for aircraft gunfire and materiel mounted in an aircraft with onboard guns. Guidance in this Annex is to be used only if in-service measured materiel response data is not available or will not be available in the early stages of a development program. This Annex is not intended to justify the use of sine-on-random or narrowband random-on-random for cases in which measured data displays a broadband spectra along with components at discrete frequencies. Use the information in this Annex only if it is vital to the design of the materiel. If there is a possibility of obtaining early measurements of the materiel response mounted on the in-service platform, supplant the severity's developed using the information in this Annex with the severity's estimated from the materiel response under in-service measurements and one of the other procedures used for testing. In particular, if the measured materiel response in-service environment has the character of high level broadband random vibration with no characteristics conducive to application of Procedure II or Procedure III, then

- a. apply Procedure I in the form of transient vibration, or
- b. submit the materiel to a specified level of high level broadband random vibration (based on ASD estimates of the measured in-service materiel response) over a period of time consistent with low cycle fatigue assumptions in accelerated testing or as specified in the test plan (see method 514.5).

2. DEVELOPMENT.**2.1 Introduction.**

This Annex is essentially a reorganized reproduction of the information contained in reference a. of paragraph 2.5. with some additional guidance. Mention of the pulse method in paragraph I-4.4.1 of reference a. has not been included, but is covered in reference b. that provides insight into the use of the pulse method in conjunction with a predictive rationale. Procedure IV differs from the other three procedures in that it is a result of a prediction procedure developed on the basis of an analysis of a comparatively small set of measured gunfire materiel response data. The predicted spectrum therefore provides estimates of materiel vibration response that may be substantially different from in-service measured vibration response of a particular materiel. For a particular materiel and gun/materiel configuration, materiel response to gunfire is generally not amenable to accurate prediction. The prediction methodology provided below is generally subject to a large degree of uncertainty with respect to test level. This uncertainty is very apparent in gunfire configurations where the gun is less than a meter from the materiel.

MIL-STD-810F
1 January 2000
ANNEX D

2.2 Predicting Gunfire Vibration Spectra.

Gunfire vibration prediction spectra consist of a broadband spectrum representative of an ASD estimate from stationary random vibration along with four harmonically related sine waves. Figure 519.5D-1 provides a generalized vibration spectrum for gunfire-induced vibration that defines the predicted response of materiel to a gunfire environment. It is characterized by four single frequency harmonically related (sine) vibration peaks superimposed on a broadband random vibration spectrum. The vibration peaks are at frequencies that correspond to the nominal gunfire rate and the first three harmonics of the gunfiring rate. The specific values for each of the parameters shown on figure 519.5D-1 can be determined from table 519.5D-I, table 519.5D-II, table 519.5D-III, and figures 519.5-2 through 8. The suggested generalized parametric equation for the three levels of broadband random vibration, T_j , defining the spectrum on figure 519.5D-1 is given in dB for g^2/Hz (reference to $1 g^2/\text{Hz}$) as

$$10\log_{10}(T_j) = 10\log_{10}(N F_1 E) + H + M + W + J + B_j - 53 \text{ dB} \quad j=1,2,3 \quad (\text{D-1})$$

where the parameters are defined in table 519.5D-I. The suggested generalized parametric equation for the four levels of single frequency (sine) vibration defining the spectrum on figure 519.5D-1 is given in dB for g^2/Hz (reference to $1 g^2/\text{Hz}$) as

$$10\log_{10}(P_i) = 10\log_{10}(T_3) + K_i + 17 \text{ dB} \quad i=1,2,3,4 \quad (\text{D-2})$$

where the parameters are defined in table 519.5D-I.

The key geometrical relations used to determine the predicted vibration spectra are the following four geometrical factors :

- Vector distance (D). The vector distance from the muzzle of the gun to the mean distance between materiel support points as shown on figure 519.5D-2. For configurations involving multiple guns, the origin of vector D is determined from the centroidal point of the gun muzzle, as shown on figure 519.5D-3. Figure 519.5D-7 and figure 519.5D-8 provide for spectra reduction factors related to D for the random spectra and the discrete frequency spectra, respectively.
- Gun standoff distance (h). The distance normal to the aircraft's surface as shown on figure 519.5D-4.
- Depth parameter (R_s). The distance normal to the aircraft's skin to the materiel location inside the aircraft. If R_s is unknown, use $R_s = 7.6 \text{ cm}$ (see figure 519.5D-2). Figure 519.5D-6 provides spectra reduction factors related to R_s .
- Gun caliber (c). Table 519.5D-III defines the gun caliber parameter, c, in millimeters and inches.

For this procedure, base the vibration peak bandwidths consistent with windowed Fourier processing on in-service measured materiel response data if available. When such in-service data are not available, the vibration peak bandwidths can be calculated as:

$$BW_{3\text{dB}} = (\pi F^{1/2})/4 \quad (\text{D-3})$$

for

$BW_{3\text{dB}}$ = the bandwidth at a level 3dB (factor of 2) below the peak ASD level

F = the fundamental frequency or one of the harmonics F_1 , F_2 , F_3 , or F_4

For cases where the gunfiring rate changes during a development program or the gun may be fired at a sweep rate, it is desirable to either (1) perform sinusoidal sweeps within the proposed bandwidth for the fundamental and each harmonic or (2) apply narrowband random vibration levels provided the sweep frequency bandwidth is not too large. This technique may over-predict those frequencies where the attachment structure or materiel responses become significantly nonlinear. Likewise, for those cases in which the attachment structure or materiel resonances coincide with the frequencies in the gunfire environment, the materiel vibration response could be under-predicted. The practitioner should clearly understand the options available and inherent limitations in the vibration control system software.

METHOD 519.5

2.3 Duration of Test.

Use a duration for the gunfire vibration test in each of the three axes, equivalent to the expected total time the materiel will experience the environment in in-service use. This duration may be conservatively estimated by multiplying the expected number of aircraft sorties in which gunfiring will occur by the maximum amount of time that gunfiring can occur in each sortie. The number of sorties in which gunfire will occur will be associated with planned aircraft training and combat utilization rates, but will generally be in the vicinity of 200 to 300 sorties. The maximum time of gunfire per sortie can be determined from table 519.5D-II by dividing total rounds per aircraft by the firing rate. When a gun has more than one firing rate, perform the test using both firing rates, with test time at each firing rate based on the expected proportion of time at each firing rate for in-service use. The guns carried by an aircraft are generally fired in short bursts that last a few seconds. Testing to a gunfire environment should reflect a form of in-service use in compliance with the test plan. For example, vibration could be applied for two seconds followed by an eight-second rest period during which no vibration is applied. This two-second-on/eight-second-off cycle is repeated until the total vibration time equals that determined for the aircraft type and its in-service use. This cycling will prevent the occurrence of unrealistic failure modes due to vibration isolator overheating or buildup of materiel response in continuous vibration. Intermittent vibration can be achieved by several means including (1) the interruption of the exciter input signal, and (2) a waveform replication strategy for transient vibration discussed in Annex A.

2.4 Spectrum Generation Techniques.

Gunfire materiel response vibration is characterized by broadband random vibration with four vibration peaks that occur at the first three harmonics and the fundamental frequency of the firing rate of the onboard guns. Virtually all modern vibration control system software packages contain a provision for performing a gunfire vibration test based on this form of predicted sine-on-random spectra. The details of these software packages are in general proprietary, but the practitioner is expected to have a clear understanding of the capabilities and limitations of the software. On occasion it has been noted that the dynamic range required to produce and control a specified gunfire spectrum is beyond the ability of some available vibration controllers. A way of solving this problem is to enter into the vibration controller the desired broadband random spectrum with its strong vibration peaks. At those frequencies that have the intense vibration peaks, sine waves may be electronically added to the input of the vibration exciter amplifier. Ensure the amplitude of these sine waves is such that the vibration levels produced at those frequencies is slightly less than the desired spectrum level. The vibration controller can make the final adjustment to achieve the needed test level. It is important to note that P_i is in terms of g^2/Hz and not g 's, (care must be exercised in specifying the amplitude of the sine waves in g 's or equivalently input voltage corresponding to a g level). This means of environment replication allows the gunfire vibration test to be done closed loop with commonly available laboratory test equipment and control system software.

2.5 Reference/Related Documents.

- a. MIL-STD-810E Method 519.4, 14 July 1989.
- b. Merritt, R. G., "A Note on Prediction of Gunfire Environment Using the Pulse Method", IEST, 40th ATM, Ontario, CA, May 1999.

3. RECOMMENDED PROCEDURES.

3.1 Recommended Procedure.

For aircraft vibration for materiel mounted in the aircraft with no available measured data, use this procedure with the prediction methodology. For cases in which available measured data demonstrate only broadband high level vibration with no "discrete" components, use this procedure.

MIL-STD-810F
1 January 2000
ANNEX D

3.2 Uncertainty Factors.

This procedure includes substantial uncertainty in general levels because of the sensitivity of the gunfire environment to gun parameters and geometrical configuration. It may be appropriate to increase levels or durations in order to add a degree of conservativeness to the testing. Change in levels, durations, or both for the sake of increasing test conservativeness must be backed up with rationale and supporting assessment documentation. Since extreme spectra prediction levels do not necessarily provide test inputs that correlate with measured data (for the same geometrical configuration), the uncertainty in damage potential is increased substantially as the predicted spectra increase in level, i.e., testing with this procedure may be quite unconservative.

TABLE 519.5D-I. Suggested generalized parametric equations for gunfire-induced vibration.

| | |
|---|---|
| $10 \log_{10} (T_j) = 10 \log_{10} (N F_1 E) + H + M + W + J + B_j - 53 \text{ dB}$ | |
| $10 \log_{10} (P_i) = 10 \log_{10} (T_3) + K_i + 17 \text{ dB}$ | |
| for | |
| N | Maximum number of closely spaced guns firing together. For guns that are dispersed on the host aircraft, such as in wing roots and in gun pods, separate vibration gunfire test spectra are determined for each gun location. The vibration levels, for test purposes, are selected for the gun that produces the maximum vibration levels. |
| E | Blast energy of gun (see table 519.5D-III). |
| H | Effect of gun standoff distance, h (see figure 519.5D-4). |
| M | Effect of gun location $M = 0$ unless a plane normal to the axis of the gun barrel and located at the muzzle of the gun does not intersect the aircraft structure, then $M = -6 \text{ dB}$. |
| W | Effect of weight of the equipment to be tested (use figure 519.5D-5). If the weight of the materiel is unknown, use $W = 4.5 \text{ kilograms (10 lbs)}$. |
| J | Effect of the materiel's location relative to air vehicle's skin (use figures 519.5D-2 and 519.5D-6). |
| B_j | Effect of vector distance from the gun muzzle to the materiel location (see figure 519.5D-7). |
| F_1 | Gunfiring rate where $F_1 =$ fundamental frequency from table 519.5D-II ($F_2 = 2F_1, F_3 = 3F_1, F_4 = 4F_1$) |
| T_j | Test level in g^2/Hz |
| P_i | Test level for frequency F_i in g^2/hz (where $i = 1$ to 4) |
| K_i | Effect of vector distance on each vibration peak, P_i (see figure 519.5D-8). |

Note: These equations are in metric units. The resultant dB values are relative to $1 \text{ g}^2/\text{Hz}$.

TABLE 519.5D-II. Typical gun configurations associated with aircraft classes.

| Aircraft/Pod | Gun (Quantity) | Location | Firing Rate | | Capacity |
|--------------|------------------------|-----------------------|-------------|------------|----------|
| | | | Rnds/Min | Rnds/Sec | |
| A-4 | MK12 (2) | Wing roots | 1000 | 16.6 | 100/Gun |
| A-7D | M61A1 (1) | Nose, left side | 4000 & 6000 | 66.6 & 100 | 1020 |
| A-10 | GAU-8/A (1) | Nose | 2100 & 4200 | 35 & 70 | 1175 |
| A-37 | GAU-2B/A (1) | Nose | 6000 | 100 | 1500 |
| F-4 | M61A1 (1) | Nose | 4000 & 6000 | 66.6 & 100 | 638 |
| F-5E | M39 (2) | Nose | 3000 | 50 | 300/Gun |
| F-5F | M39 (1) | Nose | 3000 | 50 | 140 |
| F-14 | M61A1 (1) | Left side of nose | 4000 & 6000 | 66.6 & 100 | 676 |
| F-15 | M61A1 (1) | Right wing root | 4000 & 6000 | 66.6 & 100 | 940 |
| F-16 | M61A1 (1) | Left wing root | 6000 | 100 | 510 |
| F-18 | M61A1 (1) | Top center of nose | 4000 & 6000 | 66.6 & 100 | 570 |
| F-111 | M61A1 (1) | Underside of fuselage | 5000 | 83.3 | 2084 |
| GEPOD 30 | GE430 (1) (GAU-8/A) | POD | 2400 | 40 | 350 |
| SUU-11/A | GAU-2B/A (1) | POD | 3000 & 6000 | 50 & 100 | 1500 |
| SUU-12/A | AN-M3 (1) | POD | 1200 | 19 | 750 |
| SUU-16/A | M61A1 (1) | POD | 6000 | 100 | 1200 |
| SUU-23/A | GAU-4/A (1) | POD | 6000 | 100 | 1200 |

MIL-STD-810F
1 January 2000
ANNEX D

TABLE 519.5D-III. Gun specifications.

| Gun | Gun Caliber, c | | Blast Energy, E (J)* |
|----------|----------------|------|-------------------------|
| | mm | in | |
| GAU-2B/A | 7.62 | .30 | 6,700 |
| GAU-4/A | 20 | .79 | 74,600 |
| GAU-8/A | 30 | 1.18 | 307,500 |
| AN-M3 | 12.7 | .50 | 26,000 |
| M3 | 20 | .79 | 83,000 |
| M24 | 20 | .79 | 80,500 |
| M39 | 20 | .79 | 74,600 |
| M61A1 | 20 | .79 | 74,600 |
| MK11 | 20 | .79 | 86,500 |
| MK12 | 20 | .79 | 86,500 |

* joules (J) x 0.7376 = foot-pounds

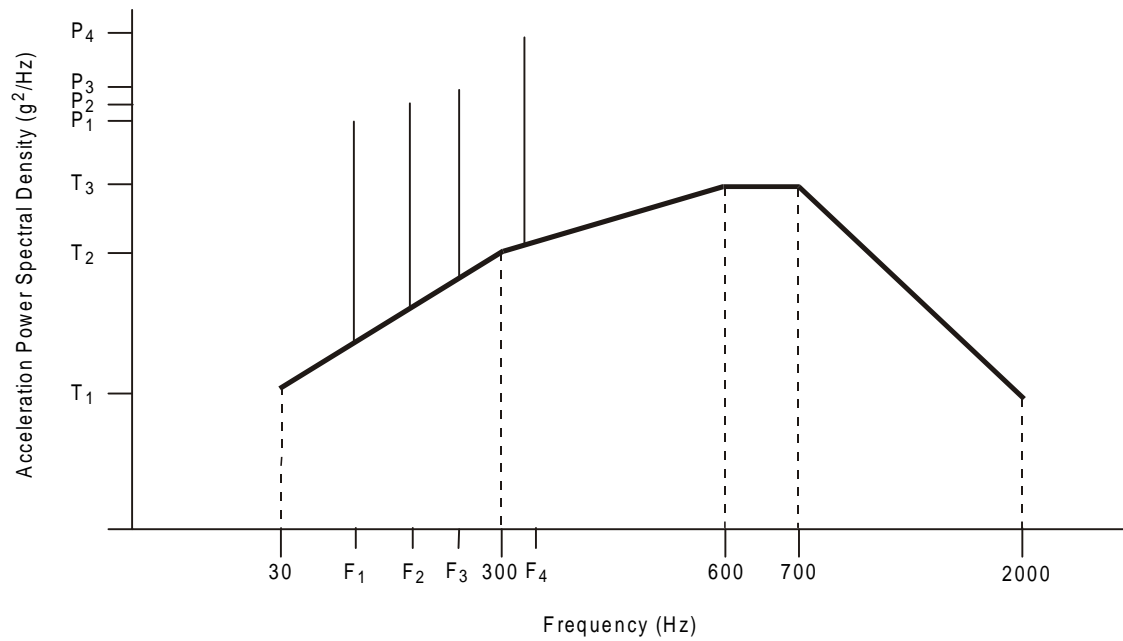

FIGURE 519.5D-1. Generalized gunfire induced vibration spectrum shape.

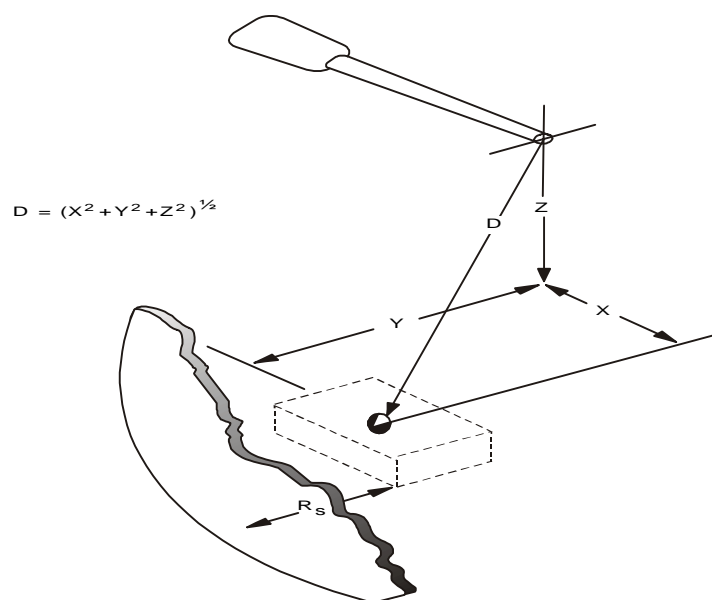

FIGURE 519.5D-2. The distance parameter (D) and the depth parameter (R_s)

s

MIL-STD-810F
 1 January 2000
 ANNEX D

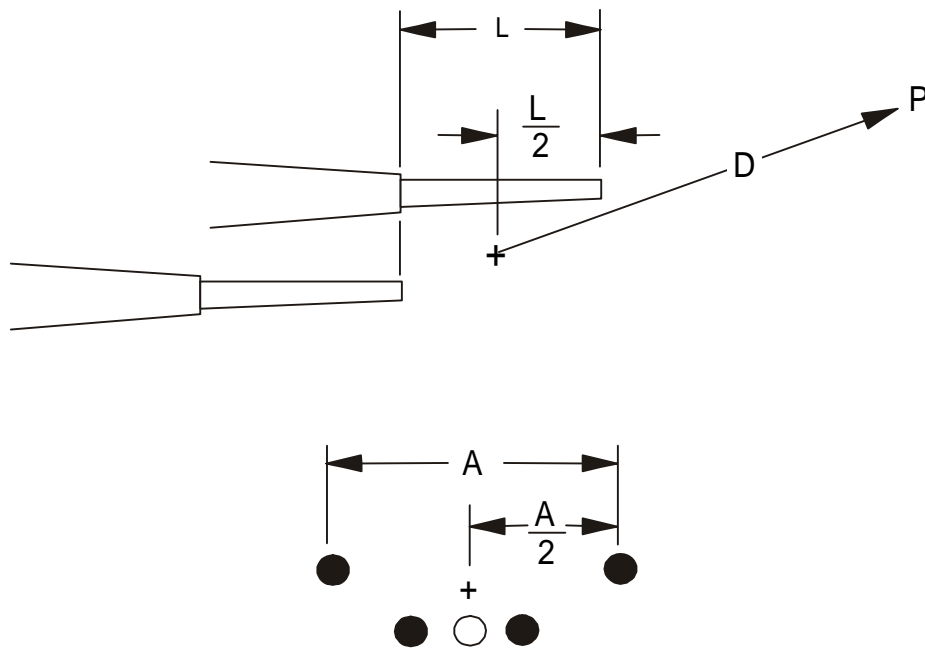

FIGURE 519.5D-3. Multiple guns, closely grouped.

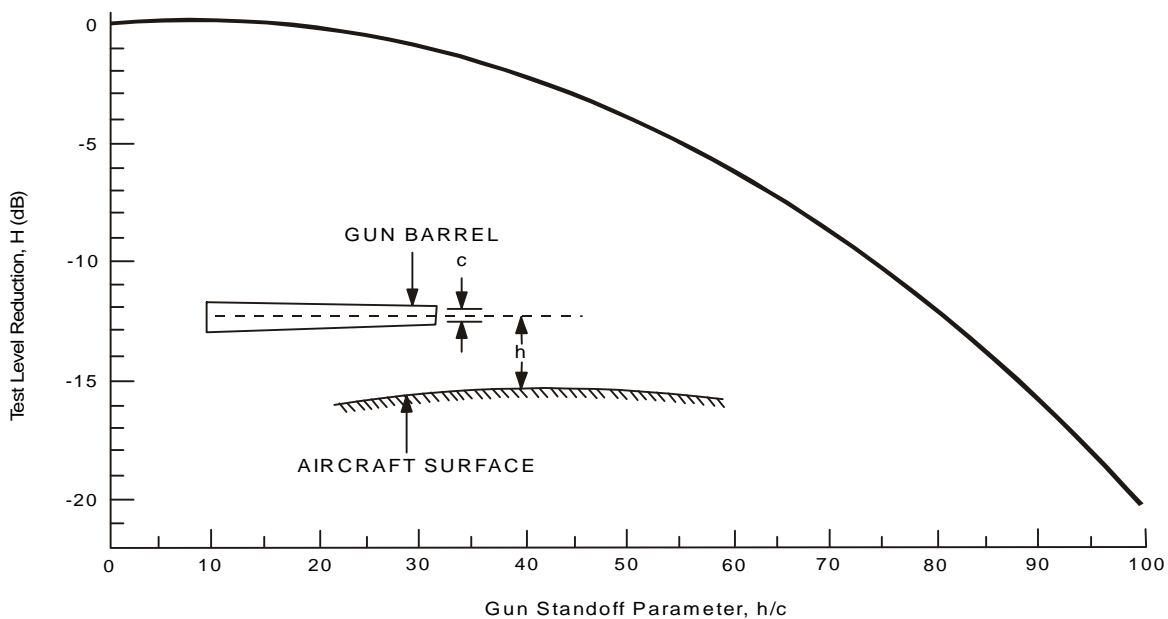

FIGURE 519.5D-4. Test level reduction due to gun standoff parameter.

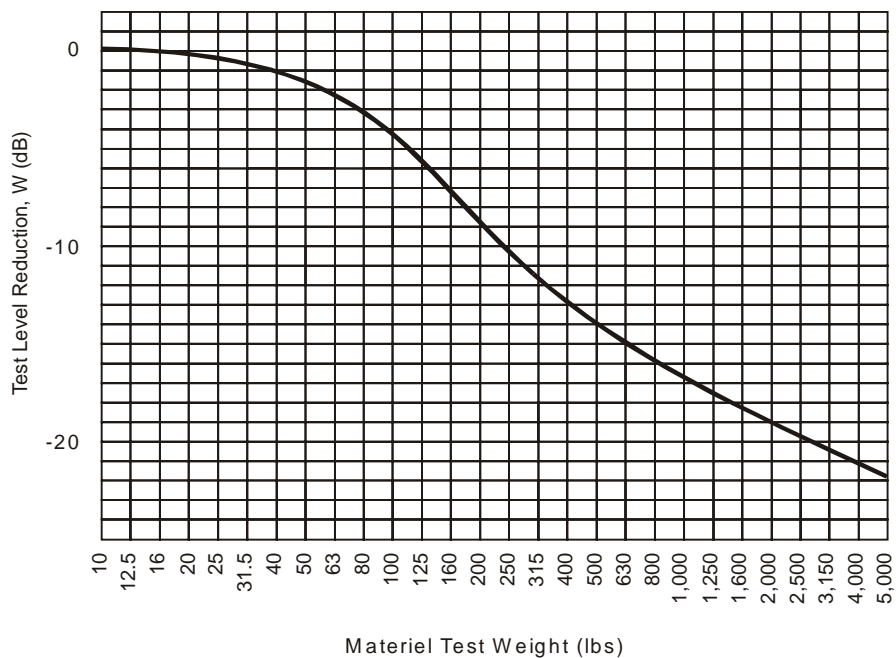

FIGURE 519.5D-5. Test level reduction due to materiel mass loading.

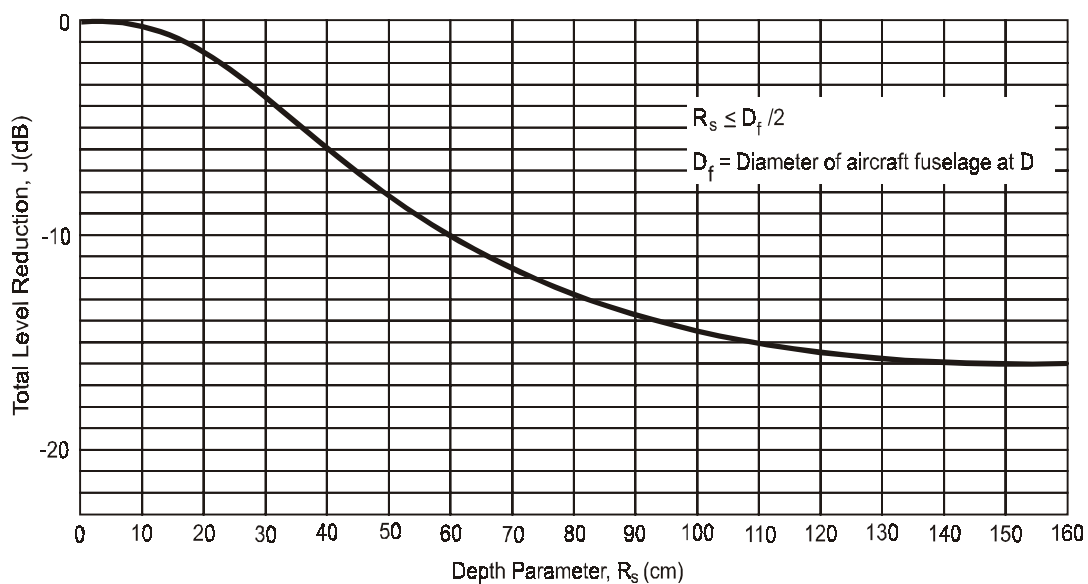

FIGURE 519.5D-6. Test level reduction due to depth parameter.

MIL-STD-810F
 1 January 2000
 ANNEX D

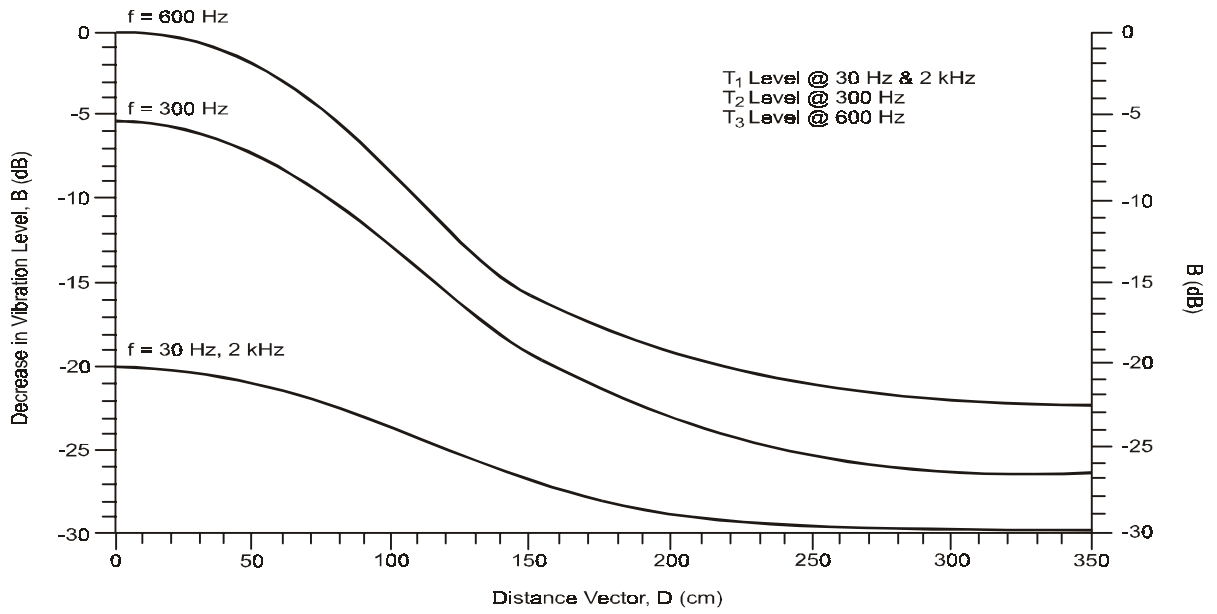

FIGURE 519.5D-7. Decrease in vibration level with vector distance from gun muzzle.

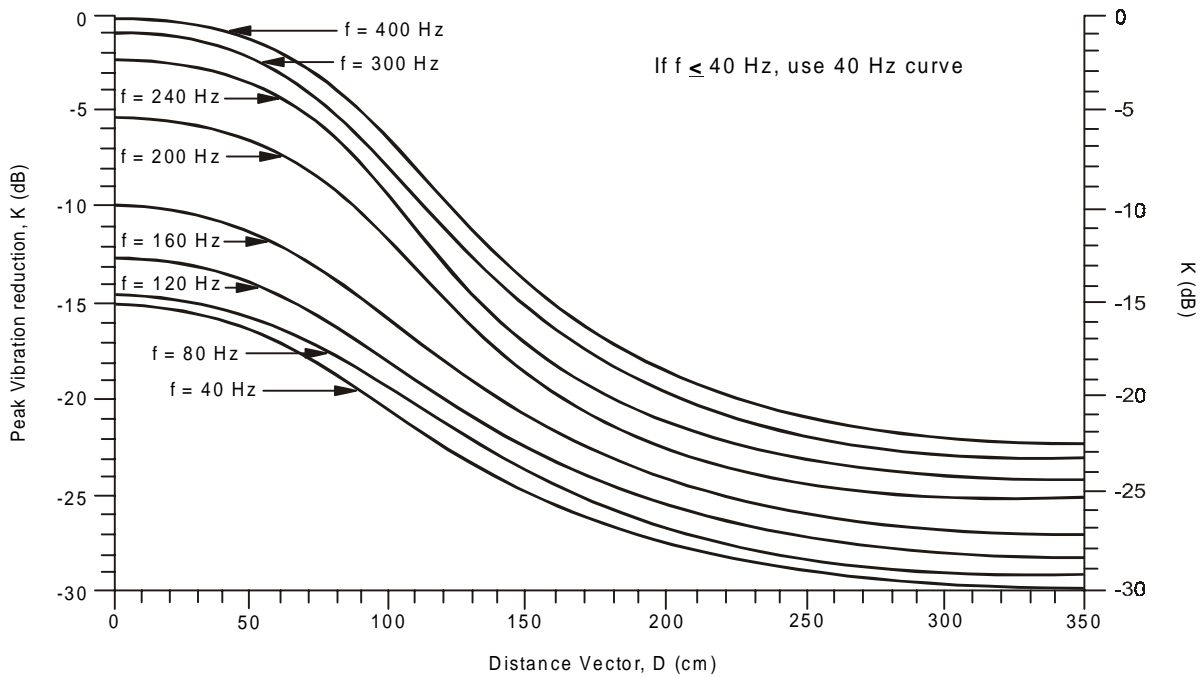

FIGURE 519.5D-8. Gunfire peak vibration reduction with distance.

METHOD 520.2

TEMPERATURE, HUMIDITY, VIBRATION, AND ALTITUDE

NOTE: Tailoring is essential. Select methods, procedures, and parameter levels based on the tailoring process described in Part One, paragraph 4, and Appendix C. Apply the general guidelines for laboratory test methods described in Part One, paragraph 5 of this standard.

1. SCOPE.

1.1 Purpose.

The purpose of this test is to help determine the combined effects of temperature, humidity, vibration, and altitude on airborne electronic and electro-mechanical materiel with regard to safety, integrity, and performance during ground and flight operations. Some portions of this test may apply to ground vehicles, as well. In such cases, references to altitude considerations do not apply.

1.2 Application.

- a. Use this method to evaluate materiel likely to be deployed in altitude areas (above ground level) where temperature, humidity, and vibration may combine to induce failures.
- b. Use this method for engineering development, for support of operational testing, for qualification, and for other similar purposes. This method is primarily intended for actively powered materiel operated at altitude, i.e., aircraft, missiles, etc.
- c. Use this method to provide an option for use of vibration in combination with the climatic elements, or for use of the climatic tests in combination with each other. This is often noted throughout the text. Generally, the combined environment test simulates those synergistic environmental effects that occur for the majority of the deployment life. Environmental stresses may be tested in combination using method 520.2, or singly using methods 500.4, 501.4, 502.4, 507.4, and 514.5, appropriately.

1.3 Limitations.

- a. Limit use of this method to evaluating the combined effects of altitude, temperature, humidity, and vibration.
- b. Some procedures permit testing for the effects of one forcing function at a time and stressing materiel items beyond realistic limits. Doing so may reduce or eliminate synergistic or antagonistic effects of combined stresses, or may induce failures that would not occur under realistic conditions.
- c. This method does not apply to unpowered materiel transported as cargo in an aircraft.
- d. The tailored test cycle should not include short duration vibration events or those that occur infrequently in the test cycle. These events include firing of on-board guns, extreme aircraft motion, and shock due to hard landings. Test for these events separately using the appropriate test method.

2. TAILORING GUIDANCE.

2.1 Selecting the Temperature, Humidity, Vibration, and Altitude Method.

After examining requirements documents, apply the tailoring process in Part One of this standard to determine where these combined forcing functions of temperature, humidity, vibration and altitude are foreseen in the life cycle of the materiel in the real world. Use the following to aid in selecting this method and placing it in sequence with other methods.

MIL-STD-810F
1 January 2000

2.1.1 Effects of combined temperature/humidity/vibration/altitude environments.

Temperature, humidity, vibration, and altitude can combine synergistically to produce the following failures. The examples are not intended to be comprehensive:

- a. Shattering of glass vials and optical materiel. (Temperature/Vibration/Altitude)
- b. Binding or loosening of moving parts. (Temperature/Vibration)
- c. Separation of constituents. (Temperature/Humidity/Vibration/Altitude)
- d. Performance degradation in electronic components due to parameter shifts. (Temperature/Humidity)
- e. Electronic optical (fogging) or mechanical failures due to rapid water or frost formation. (Temperature/Humidity)
- f. Cracking of solid pellets or grains in explosives. (Temperature/Humidity/Vibration)
- g. Differential contraction or expansion of dissimilar materials. (Temperature/Altitude)
- h. Deformation or fracture of components. (Temperature/Vibration/Altitude)
- i. Cracking of surface coatings. (Temperature/Humidity/ Vibration/Altitude)
- j. Leakage of sealed compartments. (Temperature/Vibration//Altitude)
- k. Failure due to inadequate heat dissipation. (Temperature/Vibration /Altitude)

2.1.2 Sequence among other methods.

- a. General. See Part One, paragraph 5.5.
- b. Unique to this method. Procedure I is intended to be used before final materiel designs are fixed. If done separately, perform vibration prior to the remaining environments.

2.2 Selecting Procedures.

This method includes three temperature, humidity, vibration, and altitude test procedures:

- a. Procedure I (Engineering Development);
- b. Procedure II (Flight or Operation Support), and
- c. Procedure III (Qualification).

2.2.1 Procedure selection considerations.

The choice of test procedure is governed by the in-service temperature, humidity, vibration and altitude environments, and the test purpose. In general, the test purpose will drive the selection of test procedure.

2.2.2 Difference among procedures.

While all of the procedures cover the same forcing functions, they differ on the basis of the stage of development of the materiel being tested, test severity due to acceleration, and scope of the included test profiles.

2.2.2.1 Procedure I - Engineering Development.

Use Procedure I to help find defects in a new design while it is still in the development stage. This procedure is accelerated and failure-oriented, such that it is more likely to uncover design defects compared to using a more benign procedure. A combined environment test is good for this purpose since it does not require the identification of which of the four elements of this method is most critical, and allows tailoring of the procedure accordingly. Perform single environment tests in this procedure to verify design margins. This procedure may be accelerated by eliminating the more benign conditions or by using higher stress levels than the item is likely to encounter in the field. Duration of this test should reflect total expected operating life. This test may focus on specific environmental

effects as listed in paragraph 2.1.1 and ignore effects of less concern. However, using single parameters and stressing materiel items beyond realistic limits may reduce or eliminate synergistic or antagonistic effects of combined stresses, or may induce failures that would not occur under realistic conditions. Given these cautions, use Steps 1, 2, and 4-12 of the Test Development Schedule, paragraph 4.5.1.3.

2.2.2.2 Procedure II - Flight or Operation Support.

This procedure is performed in preparation for, during, and after flight or operational testing. Its purpose is to use laboratory testing in lieu of flight testing to more quickly evaluate environmental problems discovered in flight testing. This test is not accelerated; the damage accumulation in the test should be no faster than in operational or in-flight testing. Therefore, development hardware can be interchanged between laboratory and flight or operational testing. When unusual problems develop in flight or operational testing, the materiel can be brought into the laboratory to help identify any environmental contribution to the observed problem. In general, a single cycle is adequate to verify problems. Test duration is sufficient to identify development hardware performance rather than total expected hardware life. Perform Steps 1, 2, 5, and 7-12 of the Test Development Schedule, paragraph 4.5.1.3.

2.2.2.3 Procedure III - Qualification.

The qualification test is intended to demonstrate compliance with contract requirements. Often, qualification testing is an accelerated test that emphasizes the most significant environmental stress conditions. Include in the qualification test the maximum amplitude of each stress and any unique combinations of stress types that were found to be important in the engineering development testing of the materiel. Use a test duration that reflects total expected hardware life. Perform all steps in the Test Development Schedule, 4.5.1.3.

2.2.3 Selecting combined environments.

Testing can be accomplished either with a single test that combines all the appropriate environmental stresses, or with a series of separate combined tests. When the use of separate combined tests is adopted, the most common combined tests are vibration/temperature, temperature/altitude/humidity, and humidity/temperature with supplemental cooling. Apply the following guidance:

2.2.3.1 Vibration/temperature.

Use the test conditions and durations recommended in method 514.5 for qualification testing in combination with temperatures from methods 501.4 and 502.4. Values should be tailored using the information in paragraph 2.3.

2.2.3.2 Temperature/altitude/humidity.

This test is particularly useful for the conditions present in an equipment bay or cockpit. Identify the maximum and minimum temperatures during deployment at which the materiel is expected to operate. If possible, obtain the temperatures from the analysis outlined in paragraph 2.3.5. Otherwise, use tables 520.2A-II and 520.2A-III.

- a. Values in tables 520.2A-II and 520.2A-III are based on measured natural data and do not necessarily reflect the materiel response temperature.
- b. Determine the maximum altitude to be experienced by the materiel. Often the altitude (air pressure) inside a cockpit or equipment bay is different from that outside the aircraft because of cabin pressurization. If an analysis has not been performed, use the maximum flight altitude or, if unknown, use 16km (52,500 ft.).
- c. Recommended durations of stress exposure on figure 520.2A-3 are based upon anticipated extreme-case exposure durations. It is not recommended to force the test item to reach thermal stability. As would happen in actual use, the mass and power load of the test item will determine how close the test item will get to the imposed temperature.
- d. The humidity stress is based on reasonable levels that can be experienced in actual use. Unless analysis shows that the equipment bay or cockpit environment is significantly more or less humid, the level shown in table 520.2A-III is recommended.

MIL-STD-810F
1 January 2000

- e. Consider altitude simulation for a materiel that:
 - (1) is not hermetically sealed;
 - (2) uses pressurized cooling paths to transfer heat;
 - (3) has components that contain a vacuum;
 - (4) has voltages of sufficient potential to arc in the presence of rarefied air;
 - (5) requires case convective or fan cooling or for other appropriate cases. Cooling airflow is required for all materiel that use supplementary airflow as a cooling medium.

2.2.3.3 Supplemental-cooling air humidity, mass flow rate, and temperature.

This test environment is used for supplemental cooling airflow that flows directly through materiel. If possible, determine the temperature, humidity, and mass flow rate from an analysis as outlined in paragraphs 2.3.5 and 2.3.6. Otherwise, the levels in table 520.2A-III, and combined as shown in paragraph 4.5.1.2, are recommended.

2.2.3.4 Electrical stress.

Unless otherwise defined, use the electrical conditions outlined in paragraph 2.3.8.

2.2.3.5 Test item operation.

Operate the test item throughout each test as directed in paragraph 4.5.1.2, except when being exposed to maximum and minimum temperatures that occur in equipment bays or the cockpit. If separate tests are conducted, turn the test item on and off using the same schedule as if the test environments were all combined.

2.3 Determine Test Levels and Conditions.

Having selected the method (see paragraph 2.2.1), and relevant procedures (see paragraph 2.2.2, and based on the test item's requirements documents and the tailoring process), complete the tailoring process by identifying appropriate parameter levels and special test conditions and techniques for these procedures. Base selections on the requirements documents, the Life Cycle Environmental Profile, the Operational Environment Documentation (see Part One, figure 1-1), and information provided with this procedure.

- a. Determine the functions to be performed by the materiel in combined temperature, humidity, vibration, and altitude environments. Next, determine the parameter levels of the micro-environments in which the materiel is designed to be employed, such as temperature, humidity, vibration, altitude, cooling airflow, electrical stresses, rates of change, and stress cycles.
- b. Use paragraph 4.5.1.3, referenced throughout this section, to develop a test schedule.

2.3.1 Test cycle formulation.

A test cycle is defined as a unit of time where several mission profiles are simulated under different climatic conditions. In general, a test cycle has three separate temperate/humidity segments: cold and dry, warm and moist, and hot and dry. Within each segment of the test cycle, several different mission profiles may be simulated. A mission profile is defined as a performance-environmental condition-time history of a platform. For example, a fighter aircraft may predominantly fly three different missions: air superiority, ground support, and interdiction. Therefore, this aircraft has three mission profiles. Each mission profile is divided into flight phases, such as takeoff, cruise, combat, low-level penetration, etc. (figures 520.2A-1 and -2). During a test cycle, appropriately vary temperature, vibration, humidity, altitude, and cooling airflow. A ground vehicle may similarly have missions, such as fire support/evade or advance to contact. Test cycle formulation is similar to that for aircraft, but without altitude.

2.3.2 Mission profile selection.

Select the mission profiles to be used (see figure 520.2A-1). An individual platform is designed to operate within a set of specified operating mission envelopes (Mach number/altitude regime) and profiles (see figure 520.2A-2). For example, an aircraft can fly many different missions such as training, air superiority, interdiction, ground support, etc. In addition, aircraft are flown under specialized conditions that simulate a high-threat combat environment. Often, high-threat combat will generate more extreme environments.

- a. Routine deployment. Usually, not all the missions need to be included in the test cycle. Identify two or three of the most highly used or most severe mission profiles that, as a group, reasonably approximate the aggregate effect of all the missions (including low threat combat conditions). This will adequately simulate the routine deployment life. To select the mission profiles to be used, recommend the following approach.
 - (1) Identify all platform missions and the percentage of operating life appropriate for each. Obtain this information from the operational commands or the flight manual used by aircraft crews. For systems under development, use the expected design envelopes, the design mission profiles, and the design use rate of each mission when actual flight data are not available.
 - (2) Determine the missions that comprise a majority (if possible, 80 percent of total flown) of the total routine, daily mission utilization. To do this, examine the projected utilization rates for all mission profiles and rank them in order from highest to lowest. Compile the majority use rates and use them in conjunction with the mission profiles as the basis for combined environment testing. Missions with similar functions and flight characteristics can be lumped together to minimize the number of profiles to be generated. Table 520.2-I shows the distribution of missions using fighter aircraft as an example.
- b. High threat deployment. In order to simulate the high-threat environment, separately identify missions flown under the wartime skill exercise. Obtain the environmental data from the operational command or provided by the procuring agency. Once data have been obtained, construct two separate test cycles according to paragraph 2.3.1. Develop one test cycle using the mission profiles in paragraph 2.3.2a to simulate routine use, and develop another test cycle using wartime skill mission profiles to simulate usage under combat or combat-training conditions. Alternately, this might represent normal versus severe conditions for other platforms. Obtain the altitude and Mach number-versus-time values for each mission profile selected, as shown on figure 520.2A-2. Use these parameters of the mission profile to calculate the environmental stresses. Figures 520.2A-4 and -5 are included to aid in calculations.

2.3.3 Environmental stresses.

- a. Determine environmental stresses including vibration, temperature, supplemental cooling, humidity, altitude, and electrical stresses.
- b. Determine test levels for each stress from mission profile information in the manner described in paragraphs 2.3.4 through 2.3.8. Other information, such as engine rpm or data on the platform's system environmental control system (ECS) may be needed.

Table 520.2-I gives an example for using mission profiles to develop a test cycle. Since the first three missions, as a group, total 80% of the utilization rate, select these three mission profiles for combined environment testing. If any of the other missions include extreme or sustained environmental conditions not encountered in the first three missions, also select those missions containing these extreme or sustained conditions and which add the most diversity to the test cycle. If the first mission selected is utilized twice as much as the other two missions, run the first mission twice as much per cycle.

MIL-STD-810F
1 January 2000

TABLE 520.2-I. Example utilization rates of mission profiles.

| Mission | Percent Utilization Rate |
|-------------------------|--------------------------|
| Ground Attack, Training | 40 |
| Ground Attack, Combat | 20 |
| Defensive Maneuvers | 20 |
| Search and Rescue | 10 |
| Functional Check | 5 |
| Training Cycle | 5 |
| Total: | 100 |

2.3.4 Vibration stress.

Vibration stress is applicable to virtually all air and ground vehicles, including high altitude or rocket engine powered platforms.

- a. The vibration stresses to be considered for the test cycle are those due to both attached and separated aerodynamic airflow along the vehicle's external surfaces, jet engine noise, or pressure pulses from propeller or helicopter blades on the aircraft structure. Determine the vibration spectrum and level for each mission segment by careful use of measured data. Apply the guidance written below in those cases.
- b. In many instances, field/fleet flight data are not available for the specific aircraft, materiel location in the aircraft, or flight phases. In such cases, there are several analytical techniques for vibration, spectrum and level prediction that can be used to determine vibration test conditions (see method 514.5).
 - (1) Scaling vibration test conditions from data obtained on another platform at a different materiel location, or for a different flight condition has to be done with extreme care because of the numerous nonlinear relationships involved and the limited amount of data being used. For example, maneuver-induced vibration conditions generally cannot be predicted from cruise vibration data. A more prudent approach is to utilize the linear dynamic pressure models in method 514.5.
 - (2) In all cases, field/fleet flight vibration data should be in acceleration power spectral density (PSD) format based on one-third octave analysis or 20 Hz or narrower constant-bandwidth analysis. Experience has shown that the use of a standardized vibration spectrum shape and the modified levels of method 514.5 yield as good of results in terms of materiel deficiencies as the use of the highly shaped vibration spectra (section 6, reference b). Use highly shaped spectra where desirable or available.
- c. Because of the nature of vibration control equipment, it may be difficult to change vibration level and spectrum shape in a continuous, smooth manner. Therefore, the mission profile may be divided into segments over which it will be assumed that the vibration level and spectrum shape is constant for test purposes.
- d. Apply random vibration to all materiel items designated for jet installation.
- e. Use random vibration or sine superimposed on random vibration for all materiel designed for propeller aircraft. Sine-on-random or narrow band random-on-random vibration is applied to ground vehicles.
- f. Continuously apply vibration of an appropriate level and spectrum shape during mission profile simulation in the test cycle.
- g. Unless field/fleet data exist, the appropriate tables and figures of method 514.5 are used to determine vibration conditions except as modified in table 520.2-II.

- h. Since there are few synergistic vibration/altitude or vibration/humidity effects, vibration may be applied combined with temperature as part of vibration testing (method 514.5), with temperature, altitude, and humidity environments combined separately.
- i. Do not include short duration vibration or shock events and those that occur infrequently in the test cycle. These events include firing of on-board guns, vehicle barrier traversing, and shock due to hard landings. Test for these events separately using the appropriate test method.

TABLE 520.2 - II. Suggested random vibration test criteria for jet aircraft vibration exposure.

| |
|---|
| See method 514.5, table 514.5C-III. Figures for b are from metric dimensions. |
| $b = 2.70 \times 10^{-8}$ for cockpit panel materiel and materiel attached to structure in compartments adjacent to external surfaces that are smooth and free from discontinuities |
| $b = 6.11 \times 10^{-5}$ for materiel attached to structure in compartments adjacent to or immediately aft of external surfaces having discontinuities (cavities, chines, blade antennas, speed brakes, etc.) and materiel in wings, pylons, stabilizers, and fuselage aft of training edge wing root. |
| For Mach number correction, see method 514.5, table 514.5C-III. |
| For propeller aircraft and helicopters, use appropriate tables in method 514.5. |

- j. For those segments with similar vibration spectrum shape, use the following analysis to reduce the number of vibration test levels. The discussion is in terms of the suggested spectrum shapes for jet, rotary wing, or propeller aircraft of method 514.5.
 - (1) Determine the vibration level, W_o (g^2/Hz), for each mission segment using the altitude and Mach number plots for each mission. (Note: For test purposes, the larger W_o due to aerodynamic forces or W_o due to jet engine noise, etc., is utilized at any point in time in the mission). Identify the maximum W_o value that occurs in each mission.
 - (2) Consider all segments of the mission that have W_o values within three dB of maximum, as having a constant W_o value of W_{oMAX} . Consider all segments of the mission that have values between $W_{oMAX} - 3dB$ and $W_{oMAX} - 6dB$ as having a constant W_o value of $W_{oMAX} - 4.5dB$. This process of identifying three-dB bands of dynamic vibration values, over which W_o is considered to be a constant and whose value is determined by using the dynamic vibration value of the band's midpoint, is continued until the calculated W_o value is less than $0.001g^2/Hz$. For test purposes, segments of the mission with calculated values of W_o less than $0.001g^2/Hz$ can be set equal to 0.001. Each segment has a respective time in mission associated with it which is added together creating a T(MAX), T(-4.5), etc. Vibration is then applied for their respective times during the test. A single vibration level may be created using the test acceleration formula of method 514.5, but the synergistic effects in combination with temperature may be misapplied.

2.3.5 Thermal stress.

The thermal stresses that materiel experiences during a mission is dependent upon the ambient conditions in the key equipment compartment or bay (where appropriate), flight conditions, power requirements, and the performance of supplemental cooling to the materiel (where appropriate).

- a. Use the ambient outside air conditions shown in table 520.2A-I for the hot, warm-moist, and cold day environments. The hot and cold ambient environments of table 520.2A-I are based on the 20 percent worldwide climatic extreme envelopes from MIL-HDBK-310. The warm moist environment is based on the tropical environment shown in MIL-HDBK-310. These temperature values are to be used as the ambient conditions for thermodynamic analyses for the development of the mission profile test conditions. The ground soak temperatures in each mission are not necessarily related to measured data and are generally not synergistic and used for this test. The values shown in table 520.2A-II are extreme

MIL-STD-810F
1 January 2000

conditions that have been used in previous programs to accelerate stresses and reduce time between transitions from one mission to another. These values are also suitable for use in the qualification test where no other data are present.

- b. The specific environmental test conditions for any test item are dependent on the type of cooling for the compartment in which the materiel is to be located (air-conditioned, ram-air cooled, convective cooled, etc.). Often, avionic and vetronic materiel systems consist of more than one black box in different environments (e.g., when boxes are in different aircraft compartments). For the common case of a two black box system where one box is cooled by supplemental air or fluid and the other box is ambiently cooled, both boxes can be tested in one chamber as long as appropriate ambient temperature and altitude simulation for each box can be achieved. The thermal simulation would be realistic since the ambient-cooled box would respond to the ambient temperature simulation while the box that required supplemental cooling would be primarily responsive to the supplemental cooling air or fluid. Ensure the test chamber is sized for the appropriate thermal load.
- c. For this test, the following type of thermodynamic analysis is adequate. Use a more detailed analysis if desired.
 - (1) Analyze the mission profile time history of altitude and Mach number from paragraph 2.3.2 to identify each break point at which the slope of either the altitude or Mach number plots change (see figure 520.2A-2).
 - (2) Perform a thermodynamic analysis at each break point using steady-state thermodynamic relationships.
 - (3) Between each break point, perform linear interpolation on each stress to construct a continuous profile for each environmental stress.
 - (4) At each such break point, determine the modified system thermal stress conditions for a test in accordance with paragraph 2.3.5.1.

2.3.5.1 Bay conditions.

- a. Ram-cooled compartments or externally mounted system. Use this section to determine the bay temperature for an avionics or system in a compartment that is ram-cooled or otherwise ambiently cooled. Determine the thermal stress in a ram-air-cooled compartment from the following relationship.

$$T_{\text{eff}} = T_{\text{amb}}[1 + 0.18M^2]$$

where

T_{amb} = ambient air temperature (°K) at altitude being flown (table 520.2A-I)

T_{eff} = Temperature as modified by velocity air cooling effects and used in the test cycle.

M = Mach number being flown

- b. Environmental Control System (ECS) conditioned supplemental-air-cooled bay. Use this section to determine the bay temperature for an avionics or vetronics system located in a bay that receives its cooling from the platform ECS. Determine the mass flow rate and temperature of supplemental air for each break point in the mission profile. Model the onboard ECS in terms of its primary components such as pressure regulators, heat exchanger, turbo machines, water separator, etc. If the heat load from these systems is significant, include the mass flow rate being injected into the bay and the location of other systems in the calculation. Calculate the bay temperature stress using the following simplified thermodynamic assumptions.
 - (1) Assume that steady-state thermodynamic relationships are valid.
 - (2) Assume constant but nominal or typical efficiency constants that can be achieved from good design practice for turbo machinery and heat exchanger.

- (3) Neglect secondary effects in components of the ICS (i.e., pressures losses in heat exchanger, temperature losses in ducts).
- c. Materiel supplemental cooling thermal stress. Use this section to determine the effect for test items that require supplemental cooling from the platform. This cooling may be air or liquid cooling into the materiel or through a cold plate. The approach to this is identical to the thermal effects produced from the materiel bay conditions with one addition: continue the thermodynamic analysis to determine the temperature and mass flow being injected directly into the materiel.

2.3.6 Humidity stress.

The stress that a system experiences due to humidity is dependent upon the ambient humidity conditions and the performance of the water separator of the environmental control system. (Some platforms do not cool materiel with ECS air, thus the materiel sees only ambient humidity conditions.) For this test, whenever the cold day environment is being simulated, humidity will be uncontrolled, but less than or equal to the dew point temperature in table 520.2A-Ib. For the hot environment, dew point temperatures will be less or equal to values in table 520.2A-Ia. For the warm moist day, dew point temperatures will be greater than or equal to the values in table 520.2A-Ic up to 10 km altitude. Above 10 km, the dew point temperature is less than or equal to the values in table 520.2A-Ib. If the platform has an ECS, the design specifications for the warm moist day apply. When the efficiency of the ECS is unknown, use the approximation technique put forth above.

NOTE: The formation of frost or free water on the test items during combined environment testing can be a normal condition. It will normally occur whenever the temperature of the test item is cooler than the dew point temperature of the air being delivered by the ECS or from ram airflow. This is normal and a realistic condition. During some mission profiles, free water may refreeze, causing binding of moving parts, degradation of seals, and aggravating surface cracks. This may be particularly apparent in vehicle mounted hardware. The use of sprayed water on a cold part to simulate severe frost or ice accumulation is encouraged, where appropriate.

2.3.7 Altitude stress.

Use altitude simulation when there is reason to believe system performance may be affected by variations in air pressure. Examples of such situations are: hermetically sealed units that use pressurized cooling parts to maintain sufficient heat transfer; non-hermetically sealed units that require connective cooling; vacuum components where the seal is maintained by air pressure, and units where a change in air pressure may cause arcing or change of component values. When altitude effects are to be tested, apply the altitude stress or reduced atmospheric pressure variations according to the mission profiles selected for test. The rate-of-change of pressure should reflect the climb or descent rate of the aircraft while performing the various flight mission phases. Use a maximum pressure that is equivalent to that of ground elevation at the test site.

2.3.8 Electrical stress.

Electrical stresses are expected deviations of the materiel's electric supply parameters from their nominal values at the materiel terminals. The test procedure must simulate to the required extent, all electrical stresses occurring during normal operation in service (mission profile) which contribute synergistically to the environments. In addition, appropriately demonstrate operation of the test materiel's functions at each test condition. It is not the purpose of this test to simulate extremes specified for special situations or to take the place of special electrical stress tests. Simulate special conditions such as emergency operation of certain aircraft materiel within the electrical/electronic system only on request. Depending upon the requirements and the availability of data, the simulation may cover the range from the exact reproduction of the specific electric supply conditions within a special aircraft for a specific mission profile, down to a standardized simplified profile for generalized applications. Consider the following conditions and effects to determine whether they affect the operation and reliability of the materiel to be tested.

- a. AC system normal operation stresses.
- b. Normal ON/OFF cycling of materiel operation.
- c. DC system normal operation stresses.

MIL-STD-810F
1 January 2000

- d. Electrical stresses induced by mission-related transients within the electrical system.

2.3.8.1 AC & DC system normal operation stresses.

Voltage variations are quasi-steady changes in voltage from test cycle to test cycle. A suggested input voltage schedule would be to maintain the input voltage at 110 percent of nominal for the first test cycle, at the nominal for the second test cycle, and at 90 percent for the third test cycle. This cycling procedure would be repeated continuously throughout the test. However, if a failure is suspected, interrupt this sequence for repetition of input voltage conditions.

2.3.8.2 Normal ON/OFF cycling of materiel operation.

Turn the materiel on and off in accordance with materiel operating procedures outlined in appropriate technical manuals, to simulate normal use.

2.4 Test Item Configuration.

See Part One, paragraph 5.8.

3. INFORMATION REQUIRED.

3.1 Pretest.

The following information is required to perform a temperature, humidity, vibration, altitude test adequately.

- a. General. Information in Part One, paragraphs 5.7, 5.9, 5.11 and 5.12, and Part One, Appendix A, Tasks 405 and 406 of this standard.
- b. Specific to this method.
 - (1) Purpose of the test, e.g., engineering development, flight or operation support, qualification, etc.
 - (2) Combination of temperature, humidity, vibration and altitude to be applied simultaneously.

3.2 During Test.

- a. General. See Part One, paragraphs 5.10 and 5.12, and information in Part One, Appendix A, Tasks 405 and 406 of this standard.
- b. Specific to this method.
 - (1) Complete record of temperature, humidity, vibration and altitude levels of input with sequence.
 - (2) Complete record of materiel function correlated with input sequence.

3.3 Post-test.

The following post-test information is required.

- a. General. Information listed in Part One, paragraph 5.13, and in Part One, Appendix A, Tasks 405 and 406 of this standard.
- b. Specific to this method. Any anomalies in the input sequence with assessment of the efforts on the test results.

4. TEST PROCESS.

4.1 Test Facility.

Use a facility that can provide the required combination of environmental elements. See the guidance for the facilities for the individual element tests, i.e., methods 500.4, 501.4, 502.4, 507.4, and 514.5. Ensure the facility satisfies the requirements of Part One, paragraph 5.

4.2 Controls.

Ensure calibration and test tolerance procedures are consistent with the guidance provided in Part One, paragraphs 5.3.2 and 5.2, respectively.

4.3 Test Interruption.

- a. General. See Part One, paragraph 5.11 of this standard.
- b. Specific to this method.
 - (1) Undertest interruption. Refer to the interruption guidance for the individual test elements, i.e., temperature, humidity, low pressure, and vibration.
 - (2) Overtest interruption. Refer to the interruption guidance for the individual test elements, i.e., temperature, humidity, low pressure, and vibration.

4.4 Data Analysis.

Detailed data analysis for verification of the input to the test item and the response monitoring of the test item are to be in accordance with the test plan.

4.5 Test Execution.

The following steps, alone or in combination, provide the basis for collecting necessary information concerning the test item in a combined environment of vibration, temperature, humidity, and altitude. Begin with the first procedure specified in the test plan.

4.5.1 Preparation for test.

4.5.1.1 Preliminary steps.

Before starting the test, review pretest information in the currently approved test plan to determine test details (e.g., procedures, item configuration, cycles, durations, parameter levels for storage/operation, etc.). (See paragraph 3.1, above.)

4.5.1.2 Qualification test cycle. (Figure 520.2A-3.)

- Step 1. Ramp to Cold/Dry - With the test item non-operating, ramp the chamber temperature from room ambient conditions down to the most extreme non-operating temperature at 5°C/minute or at a maximum rate provided by ECS.
- Step 2. Cold/Dry Soak - Allow the test item to soak at the most extreme non-operating temperature until it has reached thermal stabilization or for 4 hours (whichever is greater). If vibration is to be performed during this step, derive it from a low altitude, high Mach flight condition (combined temperature/vibration may be performed separately). Ground vehicles would use severe road/field vibration levels.
- Step 3. Cold/Dry Warm-Up - Operate the test item at its minimum operating voltage. If supplemental cooling is supplied during this step, tailor cooling parameters for minimum heat removal (e.g., minimum temperature and minimum flow for air cooling at or above the minimum operating temperature). Maintain this condition for the minimum specified warm-up period.

MIL-STD-810F
1 January 2000

- Step 4. Cold/Dry Performance Check - Do a performance check immediately following Step 3 to verify the test item operates as required.
- Step 5. Ramp to Cold/Dry Altitude - With the test item operating, ramp the chamber from the site pressure to the maximum cruise altitude (use the formulas on figure 520.2A-5 to derive pressure from altitude). Perform the pressure ramp at the maximum facility rate, not to exceed the predicted platform rate. Not applicable to ground vehicles.
- Step 6. Cold/Dry Altitude - Maintain the maximum cruise altitude for 30 minutes. If vibration is to be performed during this step, derive it from a high altitude, high Mach flight condition. Not applicable to ground vehicles.
- Step 7. Ramp to Warm/Moist - Ramp the chamber conditions from Step 6 and uncontrolled humidity to 32°C (90°F) and site pressure and 95% relative humidity (RH). Perform this temperature/humidity/altitude ramp at the maximum facility rate, not to exceed the predicted platform rate. This step simulates a quick descent from a high altitude and allows an altitude chamber to simulate a high altitude descent to a hot/humid day landing site. Not applicable to ground vehicles.
- Step 8. Warm/Moist Dwell - Maintain 32°C, site pressure and 95% relative humidity for 30 minutes. If vibration is to be performed during this step, derive it from a low altitude, high Mach flight condition. Ground vehicles use an aggregate vibration schedule based on various road conditions.
- Step 9. Ramp to Hot/Dry - Ramp the chamber temperature to the maximum operating temperature and the chamber humidity to less than 30% RH. Operate the test item at its maximum operating voltage. At the same time, supply supplemental cooling at the worst case thermal conditions (e.g., maximum temperature and minimum flow for air-cooling). Perform this temperature/humidity ramp at the maximum facility rate, not to exceed the predicted platform rate.
- Step 10. Hot/Dry Soak - Allow the test item to soak at the maximum operating temperature until it has reached thermal stabilization or 2 hours (whichever is greater). If vibration is to be performed during this step, derive the vibration levels from the maximum of take-off/ascent or low altitude/high Mach (if appropriate). Ground vehicles use aggregate off-road vibration levels.
- Step 11. Hot/Dry Performance Check - Operate the test item and record data for comparison with pretest data.
- Step 12. Ramp to Hot/Dry Altitude - Ramp the chamber from site pressure to the maximum cruise altitude (use the formulas on figure 520.2A-5 to derive pressure from altitude). Perform this pressure ramp at the maximum facility rate, not to exceed the predicted platform rate. Not applicable to ground vehicles.
- Step 13. Hot/Dry Altitude - With the test item operating, maintain the maximum operating temperature and maximum cruise altitude until the test item has reached thermal stabilization or 4 hours (whichever is greater). If vibration is to be performed during this step, derive it from a high (or ultra-high if applicable) altitude, high Mach flight condition. Not applicable to ground vehicles.
- Step 14. Hot/Dry Altitude Performance Check - Do a performance check to verify that the test item operates as required.
- Step 15. Ramp to Room Ambient - Ramp the chamber from the maximum operating temperature and maximum cruise altitude to room ambient temperature, site pressure and uncontrolled humidity. Perform this temperature/pressure ramp at the maximum facility rate, not to exceed the predicted platform rate. Return the test item to a non-operating condition and discontinue the supplemental cooling at the conclusion of the ramp.
- Step 16. Repeat the cycle (Steps 1-15) as necessary to meet the test plan duration requirements or 10 cycles, whichever is greater.

4.5.1.3 Test development schedule.

Utilized for each Procedure.

- Step 1. Identify the platform missions and test materiel location.
- Step 2. Identify the mission profiles.
- Step 3. Select the top 80% of potential mission profile. (Table 520.2-I) (Procedure III only.)
- Step 4. Select most severe potential mission profile. (Exception: short term and transient events, e.g., gunfire, crash shock, etc.) (Procedures I and III).
- Step 5. Identify the vibration levels by mission profile.

- Step 6. "Normalize" high vibration utilization profile. Use severe mission profile vibration level (used for method 514.5, Procedures I and III). (See paragraph 2.3.4)
- Step 7. Create a Mach/altitude table and determine the mission profile thermal/altitude environments for hot/dry, warm/moist, and cold/dry conditions (see paragraph 2.3.2).
- Step 8. Determine the cooling environment for the test item (see paragraph 2.3.5).
- Step 9. Write a thermal, altitude, humidity, vibration profile for the most severe expected environments for hot/dry, warm/moist, and cold/dry conditions (see paragraph 2.3.3). (Temperature/vibration may be performed separately.)
- Step 10. Determine the most severe operating conditions for the materiel and incorporate them into the combined environments profile (see paragraphs 2.3.4 thru 2.3.8).
- Step 11. Determine most severe cooling environments for the materiel and incorporate them into the combined environments profile (see paragraphs 2.3.5.1 and 2.3.5.2).
- Step 12. Develop a test plan with separate and/or combined environments (see paragraph 2.2.2).
- Step 13. Perform the test.

5. ANALYSIS OF RESULTS.

Use the guidance provided in Part One, paragraphs 5.14 and 5.17, and Part One, Annex A, Tasks 405 and 406 to evaluate the test results. Analyze in detail any failure of a test item to meet the requirements of the materiel specifications. If the test item failed the test, consider the following categories during analysis of results of this method:

- a. Stress. If a failure occurred, what the immediate physical mechanism of failure may have been, e.g., fatigue, short circuit by particulate, etc.
- b. Loading mechanism. Determine the physical loading mechanism that led to failure and the total time or number of cycles to failure (e. g., structural dynamic resonant modes, mode shapes, stress distribution; static deformation due to temperature distribution, incursion of moisture, etc.).
- c. Responsibility. Whether or not the failure was in a contractor or government furnished part of the store; was the test being performed properly, or was there a test error, e.g., out of tolerance test conditions, that caused the failure.
- d. Source. Whether or not the failure was due to workmanship error, a design flaw, a faulty part, etc. This is actually an inverted way of deciding what corrective action is appropriate, since extraordinary workmanship or high-strength parts can overcome design flaws and designs can be changed to eliminate workmanship errors and/or to work with weaker parts.
- e. Criticality. Whether or not the failure would have endangered friendly forces, prevented tactical success, or required repair before delivering the store.

6. REFERENCE/RELATED DOCUMENTS.

- a. MIL-HDBK-310, Global Climatic Data for Developing Military Products.
- b. NATO STANAG 2895, Extreme Climatic Conditions and Derived Conditions for Use in Defining Design/Test Criteria for NATO Forces Materiel.
- c. Sevy, R.W. Computer Program for Vibration Prediction of Fighter Aircraft Equipment. AFFDL-TR-77-101. November 1977.
- d. Hall, P.S. Vibration Test Level Criteria for Aircraft Equipment. AFWAL-TR-80-3119. December 1980.
- e. Lloyd, A.J.P., G.S. Duleba, and J.P. Zeebenm. Environmental Control System (ECS) Transient Analysis. AFFDL-TR-77-102. October 1977.
- f. Dieckmann, A.C., et al. Development of Integrated Environmental Control Systems Design for Aircraft. AFFDL-TR-72-9. May 1972.

MIL-STD-810F
1 January 2000

- g. Quartz, I., A.H. Samuels, and A.J. Curtis. A Study of the Cost Benefits of Mission Profile Testing. AFWAL-TR-81-3028. 1981.
- h. Burkhard, A.H., et al. CERT Evaluation Program Final Report. AFWAL-TR-82-3085.
- i. F-15 AFDT&E High-Temperature Desert Test and Climatic Laboratory Evaluation. AFFTC-TR-75-19. October 1975. DTIC Number AD B011345L.

ANNEX A TABLES AND FIGURES

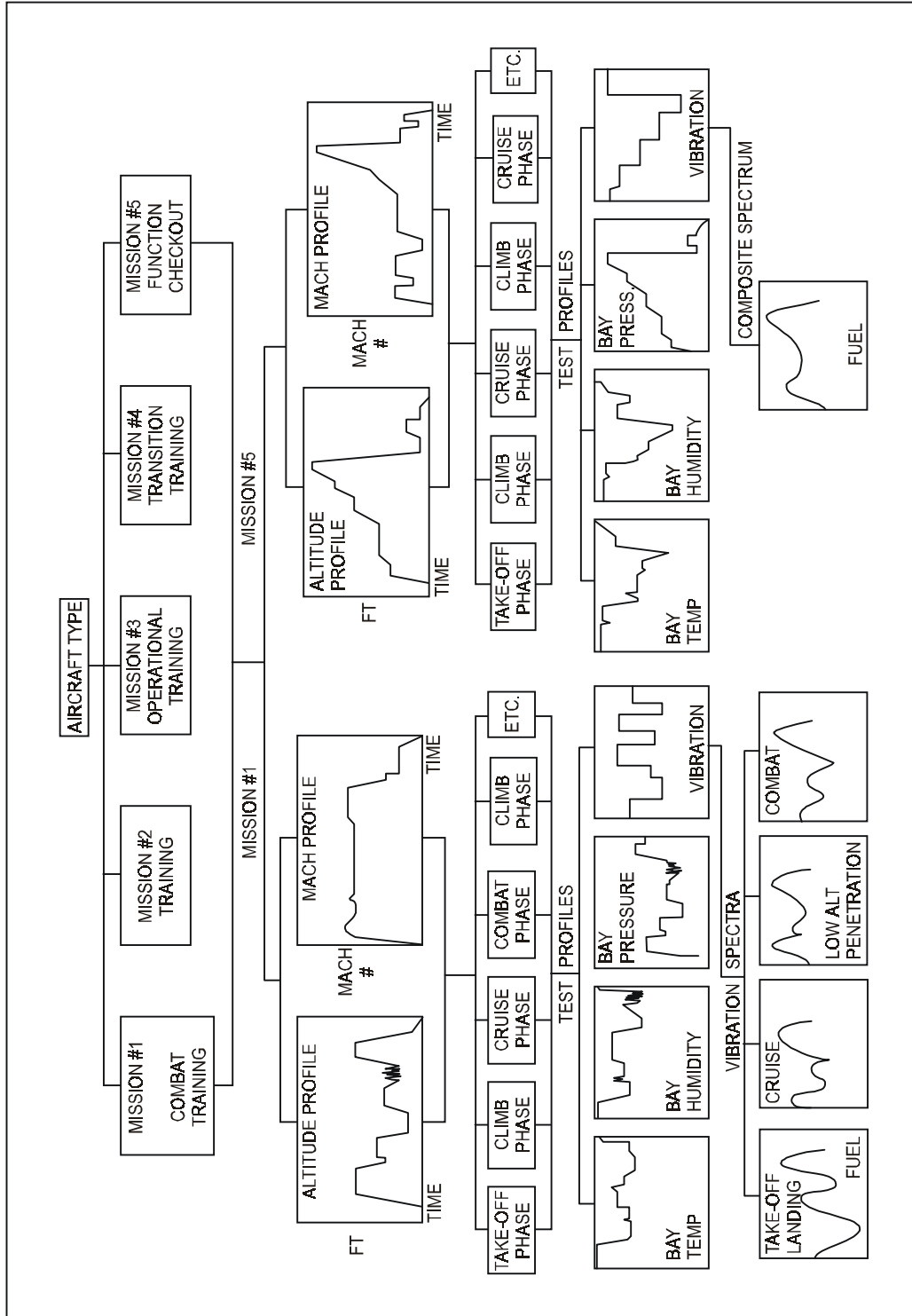

Figure 520.2A-1. Test profile generation flow diagram.

MIL-STD-810F
1 January 2000
ANNEX A

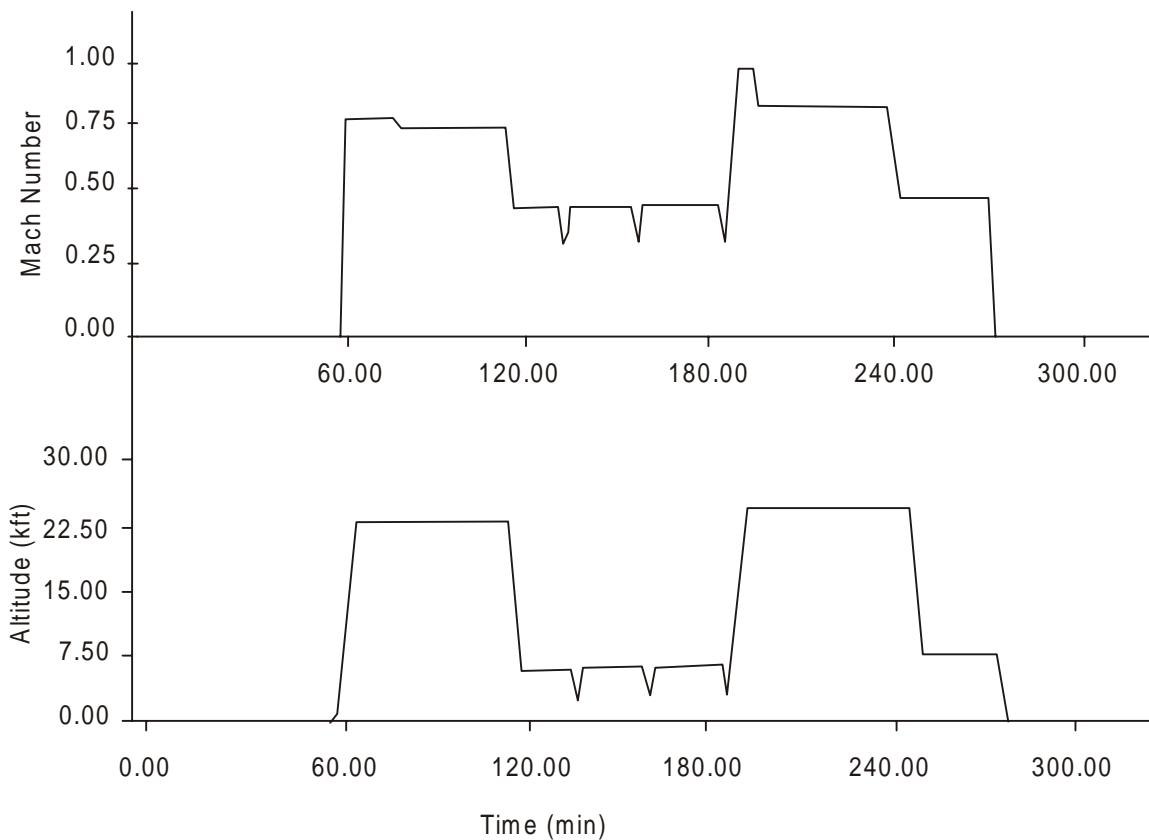
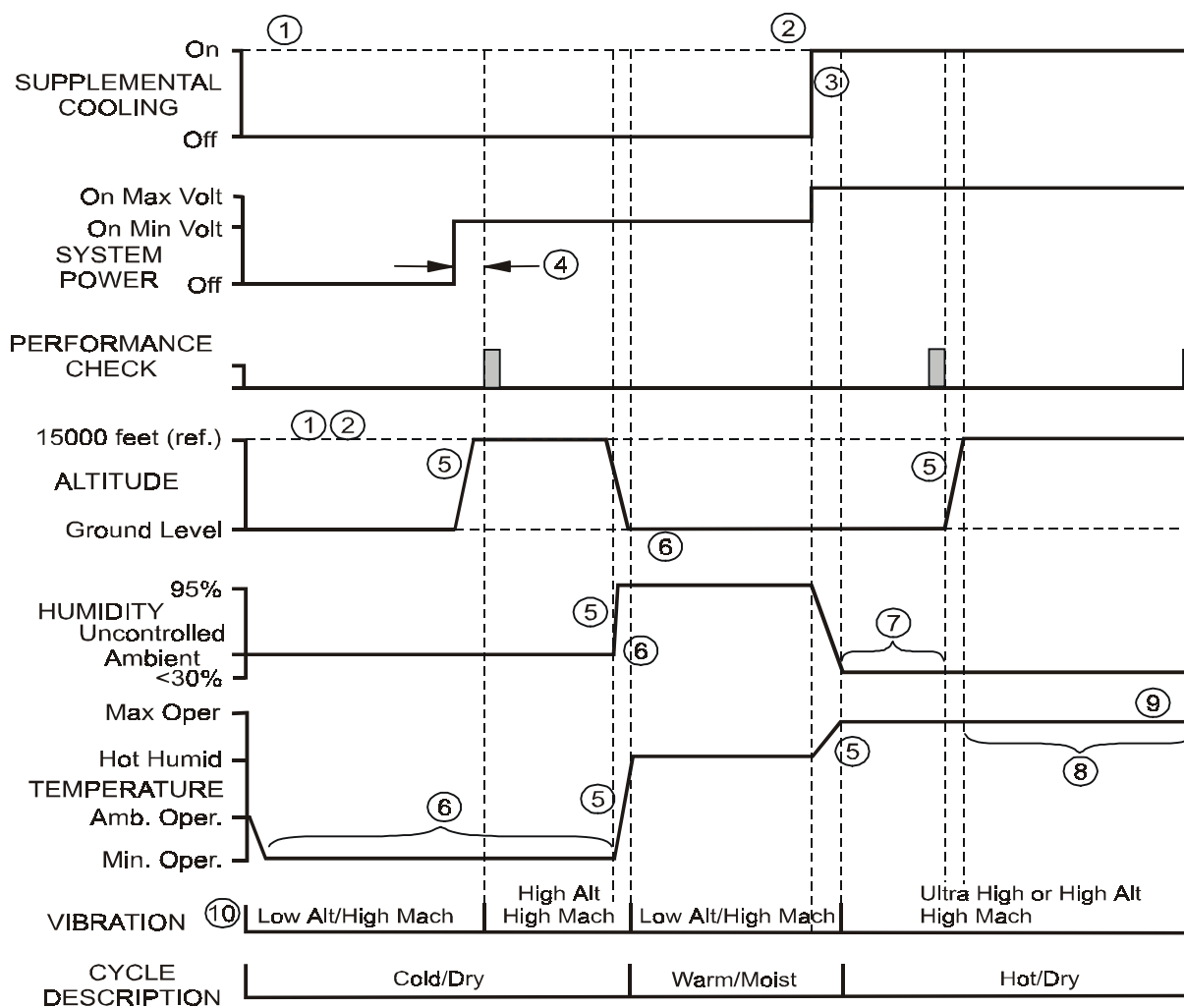

FIGURE 520.2A-2. Schematic mission profile, altitude and mach number (ground attack example).



- ① Tailor temperature and flow of supplemental cooling to provide worst case heat dissipation.
- ② Carefully tailor the platform/product specific factors.
- ③ Minimum of 20°C per minute.
- ④ Equipment warm-up time.
- ⑤ Perform transition at maximum facility capability.
- ⑥ Ideally, bleed hot/humid air into chamber (see paragraph 2.3.5b) so minimum soak follows achievement of all temperature, altitude and humidity conditions.
- ⑦ System thermal stability or 2 hours, whichever is greater.
- ⑧ System thermal stability or 4 hours, whichever is greater.
- ⑨ Carefully tailor high altitude operating temperatures.
- ⑩ Vibration may be performed separately with temperature.

FIGURE 520.2A-3. Qualification test cycle.

MIL-STD-810F
1 January 2000
ANNEX A

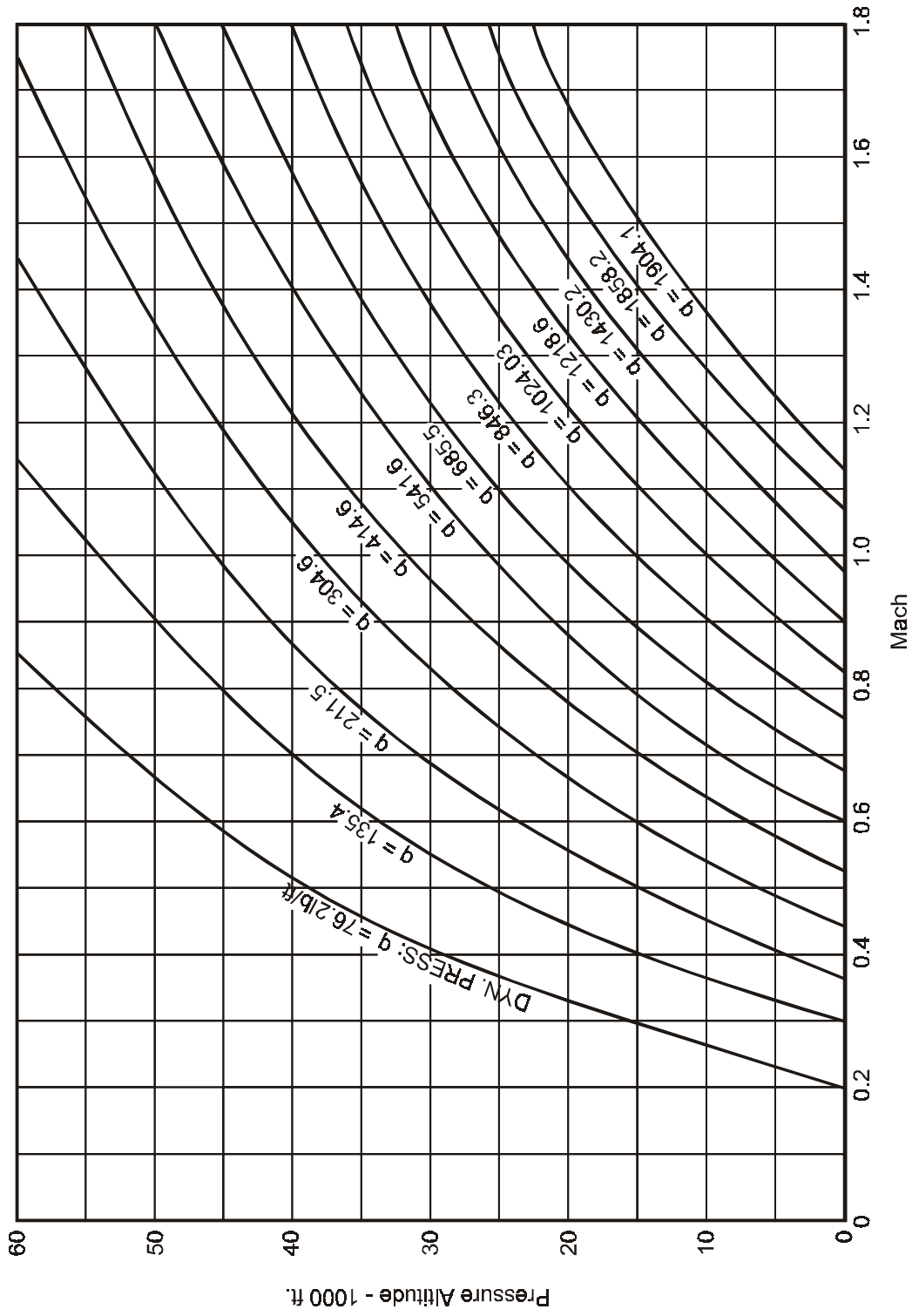

FIGURE 520.2A-4. Dynamic pressure (q) as a function of Mach number and altitude.

| Equations for Pressure Versus Altitude | |
|---|--|
| Altitude | Pressure Equation |
| $0 \text{ m} < h_p \leq 20 \text{ km}$ $(0 \text{ ft} < h_p \leq 65.62 \text{ kft})$ | $P(\text{kPa}) = 101.33 \left(\frac{288 - [6.5H(\text{km})]}{288} \right)^{5.2558}$ $P(\text{kPa}) = 101.33 \left(\frac{945 - [6.5H(\text{ft} / 1000)]}{945} \right)^{5.2558}$ |
| $h_p > 20,000 \text{ m}$ $(h_p > 65.62 \text{ kft})$ | $P(\text{kPa}) = 101.33 \left(\frac{304 - [6.5H(\text{km})]}{304} \right)^{5.2558}$ $P(\text{kPa}) = 101.33 \left(\frac{997.5 - [6.5H(\text{ft} / 1000)]}{997.5} \right)^{5.2558}$ |

FIGURE 520.2A-5. Equations for pressure versus altitude.

TABLE 520.2A-Ia. Ambient outside air temperatures.

HOT ATMOSPHERE MODEL

| Altitude (km) | Altitude (kft) | World-Wide Air Operations | | Relative Humidity (%) | Dew Temperature | |
|-------------------------------|-------------------|------------------------------|------|--------------------------|--------------------|------|
| | | (°C) | (°F) | | (°C) | (°F) |
| 0 | 0.00 | 43 | 109 | <10 | 4 | 40 |
| 1 | 3.28 | 34 | 93 | <10 | -2 | 29 |
| 2 | 6.56 | 27 | 81 | <10 | -6 | 21 |
| 4 | 13.10 | 12 | 54 | <10 | -17 | 2 |
| 6 | 19.70 | 0 | 32 | <100 | 0 | 32 |
| 8 | 26.20 | -11 | 12 | <100 | -11 | 12 |
| 10 | 32.80 | -20 | -4 | <100 ^{1/} | -20 | -4 |
| 12 | 39.40 | -31 | -24 | <100 | -31 | -24 |
| 14 | 45.90 | -40 | -40 | <100 | -40 | -40 |
| 16 | 52.50 | -40 | -40 | <100 | -40 | -40 |
| 18 | 59.10 | -40 | -40 | <100 | -40 | -40 |
| 20 | 65.60 | -40 | -40 | <100 | -40 | -40 |
| 22 | 72.20 | -39 | -38 | <100 | -39 | -38 |
| 24 | 78.70 | -39 | -38 | <100 | -39 | -38 |
| 26 | 85.30 | -39 | -36 | <100 | -38 | -36 |
| 28 | 91.90 | -36 | -33 | <100 | -36 | -33 |
| 30 | 98.40 | -33 | -27 | <100 | -33 | -27 |
| Hot Ground Soak ^{2/} | | 71 | 160 | <10 | 26 | 78 |

MIL-STD-810F
1 January 2000
ANNEX A

TABLE 520.2A – Ib. Ambient outside air temperatures.

COLD ATMOSPHERE MODEL

| Altitude | | World-Wide Air Operations | | Relative Humidity (%) | Dew Temperature | |
|--------------------------------|--------------|--------------------------------------|-------------|----------------------------------|----------------------------|-------------|
| (km) | (kft) | (°C) | (°F) | | (°C) | (°F) |
| 0 | 0.00 | -51 | -60 | <100 ^{1/} | -51 | -60 |
| 1 | 3.28 | -49 | -56 | <100 | -49 | -56 |
| 2 | 6.56 | -31 | -24 | <100 | -31 | -24 |
| 4 | 13.10 | -40 | -40 | <100 | -40 | -40 |
| 6 | 19.70 | -51 | -60 | <100 | -52 | -60 |
| 8 | 26.20 | -61 | -78 | <100 | -61 | -78 |
| 10 | 32.80 | -65 | -85 | <100 | -65 | -85 |
| 12 | 39.40 | -67 | -89 | <100 | -57 | -89 |
| 14 | 45.90 | -70 | -94 | <100 | -70 | -94 |
| 16 | 52.50 | -82 | -116 | <100 | -82 | -116 |
| 18 | 59.10 | -80 | -114 | <100 | -80 | -114 |
| 20 | 65.60 | -79 | -112 | <100 | -79 | -112 |
| 22 | 72.20 | -80 | -114 | <100 | -80 | -114 |
| 24 | 78.70 | -80 | -114 | <100 | -80 | -114 |
| 26 | 65.30 | -79 | -112 | <100 | -79 | -112 |
| 28 | 91.90 | -77 | -108 | <100 | -77 | -108 |
| 30 | 98.40 | -76 | -105 | <100 | -76 | -105 |
| Cold Ground Soak ^{2/} | | -54 | -65 | <100 | -54 | -65 |

TABLE 520.2A - Ic. Ambient outside air temperatures.

WARM MOIST ATMOSPHERE MODEL

| <u>Altitude</u> | | <u>World-Wide Air Operations</u> | | <u>Relative Humidity (%)</u> | <u>Dew Temperature</u> | |
|---------------------------|-------|--------------------------------------|------|----------------------------------|----------------------------|------|
| (km) | (kft) | (°C) | (°F) | | (°C) | (°F) |
| 0 | 0.00 | 32.1 | 90 | <85 | 29 | 85 |
| 1 | 3.28 | 25.0 | 77 | <85 | 22 | 72 |
| 2 | 6.56 | 19.0 | 66 | <85 | 17 | 62 |
| 4 | 13.10 | 4.0 | 39 | <85 | 2 | 35 |
| 6 | 19.70 | -11.0 | 13 | <85 | -13 | 9 |
| 8 | 26.20 | -23.0 | -10 | <85 | -25 | -13 |
| 10 | 32.80 | -38.0 | -36 | <100 ^{1/} | -38 | -36 |
| 12 | 39.40 | -52.0 | -62 | <100 | -52 | -62 |
| 14 | 45.90 | -67.0 | -88 | <100 | -67 | -88 |
| 16 | 52.50 | -78.0 | -108 | <100 | -78 | -108 |
| 18 | 59.10 | -73.0 | -100 | <100 | -73 | -100 |
| 20 | 65.60 | -65.0 | -85 | <100 | -65 | -85 |
| 22 | 72.20 | -58.0 | -72 | <100 | -58 | -72 |
| 24 | 78.70 | -53.0 | -63 | <100 | -53 | -63 |
| 26 | 85.30 | -48.0 | -54 | <100 | -48 | -54 |
| 28 | 91.90 | -43.0 | -45 | <100 | -43 | -45 |
| 30 | 98.40 | -38.0 | -36 | <100 | -38 | -36 |
| Ground Soak ^{2/} | | 43.0 | 109 | <75 | 37 | |

^{1/} Uncontrolled humidity (dry as possible).^{2/} Ground soak temperatures are not necessarily related to measured data but are extreme levels to reduce ground soak time.

MIL-STD-810F
1 January 2000
ANNEX A

TABLE 520.2A-II. Example: Combined environment test cycle structure.

| Test Phase Definition | Temp (°C) | Relative Humidity | Vibr. | Supp. Cooling Air (°C) | Altitude | Test Item-Operating/nonop. | Duration (min) |
|---------------------------------|------------------|--------------------------|--------------|-------------------------------|-----------------|-----------------------------------|-----------------------|
| Ground Cold Day Mission 1 | -54* | <100%* | Off On* | -54* | Ambient* | Nonoperating* | 60* |
| Ground Cold Day Mission 2 | -54* | <100%* | Off* | -54* | Ambient* | Nonoperating* | 60* |
| Ground Cold Day Mission 3 | -54* | <100%* | Off* | -54* | Ambient* | Nonoperating* | 60* |
| ** | | | | | | | |
| Transition to Hot | | | | | | | >20 |
| Ground Hot Day Mission 1 | 71* | <10%* | Off* | 71* | Ambient* | Nonoperating* | 60* |
| Ground Hot Day Mission 2 | 71* | <10%* | Off* | 71* | Ambient* | Nonoperating* | 60* |
| Ground Hot Day Mission 3 | 71* | <10%* | Off* | 71* | Ambient* | Nonoperating* | 60* |
| ** | | | | | | | |
| Transition to Moist | | | | | | | >20 |
| Ground Warm Moist Day Mission 1 | 43* | <75%* | Off* | 43* | Ambient* | Nonoperating* | 60* |
| Ground Warm Moist Day Mission 2 | 43* | <75%* | Off* | 43* | Ambient* | Nonoperating* | 60* |
| Ground Warm Moist Day Mission 3 | 43* | <75%* | Off* | 43* | Ambient* | Nonoperating* | 60* |
| ** | | | | | | | |
| Transition to Cold | | | | | | | >20 |

* Determine from aircraft mission profile.

** The number of different missions in each segment is determined in accordance with paragraph 2.3.

TABLE 520.2A-III. Typical supplemental cooling air parameters.

| Equipment Bays | Min Temp (°C) | Min Oper Temp (°C) | Max Temp (°C) | Max Oper Temp (°C) | Max Humidity (RH) | Mass Flow Rate (KG/Min) |
|--|----------------------|---------------------------|----------------------|---------------------------|--------------------------|--------------------------------|
| Supplementally Cooled | -54 | -40 | 60 | 54 | 75% at 43°C | --- |
| Ram Air Cooled | -54 | -40 | 60 | 54 | | --- |
| Unconditioned | -54 | -40 | 60 | 54 | | --- |
| CREW STATION | | | | | | |
| Open Areas | -54 | -40 | 60 | 25 | 75% at 43°C | --- |
| Behind Instrument Panels | -54 | -40 | 100 | 100 | | --- |
| Supplemental Cooling Airflow to Materiel | -51 | -51 | 54 | 54 | 75% at 43°C | +0% of design -80% point |

MIL-STD-810F
1 January 2000
ANNEX A

TABLE 520.2A-IV. Typical test schedule.

| Step | Time (1) (min) | Temp. | Alt. | Humidity (%) | Equip. Cooling | Equip. Power | Perform Check | Vibration (5) |
|------|-------------------|--------------|------|-----------------|-------------------|-----------------|------------------|------------------|
| 1 | 15 | ramp (3) | site | ambient | - | off | | low alt. |
| 2 | 240(2) | T oper. min. | site | ambient | - | off | | low alt. |
| 3 | 15 | T oper. min. | site | ambient | (4) | min. | | low alt. |
| 4 | 5 | T oper. min. | site | ambient | (4) | min. | (4) | low alt. |
| 5 | 10 | T oper. min. | ramp | ambient | (4) | min. | | high alt. |
| 6 | 30 | T oper. min. | max | ambient | (4) | min. | | high alt. |
| 7 | 10 | ramp | ramp | ramp | (4) | min. | | high alt. |
| 8 | 30 | T hum. max. | site | 95 | (4) | min. | | low alt. |
| 9 | 15 | ramp | site | ramp | worst case | max. | | low alt. |
| 10 | 120(2) | T oper. max. | site | <30 | worst case | max. | | low alt. |
| 11 | 5 | T oper. max. | site | <30 | worst case | max. | (4) | low alt. |
| 12 | 10 | T oper. max. | ramp | <30 | worst case | max. | | ult. high alt. |
| 13 | 240(2) | T oper. max. | max. | <30 | worst case | max. | | ult. high alt. |
| 14 | 5 | T oper. max. | max. | <30 | worst case | max. | (4) | ult. high alt. |
| 15 | 10 | ramp | ramp | ramp | worst case | max. | | ult. high alt. |

- (1) These times are typical examples only. Actual test times are subject to tailoring and facility limitations.
- (2) Allow sufficient time for stabilization of product temperature.
- (3) Ramp rates are subject to tailoring and facility limitations.
- (4) May be applicable depending on specific product and platform.
- (5) Vibration levels are for conditions as indicated combined with high Mach (see paragraph 2.3.4). The humidity stress is based on reasonable levels that can be experienced in actual use. Unless analysis such as outlined in paragraph 2.3.6 shows that the equipment bay or cockpit environment is significantly more or less humid, recommend using the level shown in table 520.2A-III.

METHOD 521.2

ICING/FREEZING RAIN

NOTE: Tailoring is essential. Select methods, procedures, and parameter levels based on the tailoring process described in Part One, paragraph 4, and Appendix C. Apply the general guidelines for laboratory test methods described in Part One, paragraph 5 of this standard.

1. SCOPE.

1.1 Purpose.

The icing test is conducted to evaluate the effect of icing on the operational capability of materiel. This method also provides tests for evaluating the effectiveness of de-icing equipment and techniques, including prescribed means to be used in the field.

1.2 Application.

- a. Use this method to evaluate materiel which may be exposed to icing such as produced by freezing rain or freezing drizzle. (See paragraph 2.2.1.1 below.)
- b. Use this method to develop ice accretion from sea splash or spray but the ice thicknesses may need to be modified to reflect the lower density of the ice.

1.3 Limitations.

This method does not simulate snow conditions or ice buildup on aircraft flying through supercooled clouds. Although frost occurs naturally, the effects are considered less significant and are not specifically addressed in this method. This method may not be suitable for the assessment of aerial/antenna performance, (i.e., rime ice saturated with air causes substantial signal reflection). Also not considered are the icing effects from falling, blowing or recirculating snow and wet snow or slush. These are considered less severe than those in paragraph 2.1.1.

2. TAILORING GUIDANCE.

2.1 Selecting the Icing/Freezing Rain Method.

After examining requirements documents and applying the tailoring process in Part One of this standard to determine where icing/freezing rain is anticipated in the life cycle of materiel, use the following to confirm the need for this method and to place it in sequence with other methods. This method is designed to determine if materiel can operate after ice accumulation from rain, drizzle, fog, splash or other sources. Where ice removal is required before operation, use integral deicing equipment or expedients normally available to the user in the field. Evaluate deicing equipment and expedients to assess their effectiveness and the potential for damage that may degrade performance.

2.1.1 Effects of icing/freezing rain.

Ice formation can impede materiel operation and survival and affect the safety of operating personnel. Consider the following typical problems to help determine if this method is appropriate for the materiel being tested. This list is not intended to be all-inclusive.

- a. Binds moving parts together.
- b. Adds weight to radar antennas, aerodynamic control surfaces, helicopter rotors, etc.
- c. Increases footing hazards for personnel.

MIL-STD-810F
1 January 2000

- d. Interferes with clearances between moving parts.
- e. Induces structural failures.
- f. Reduces airflow efficiency as in cooling systems or filters.
- g. Impedes visibility through windshields and optical devices.
- h. Affects transmission of electromagnetic radiation.
- i. Provides a source of potential damage to materiel from the employment of mechanical, manual, or chemical ice removal measures.
- j. Reduces efficiency of aerodynamic lifting and control surfaces.
- k. Reduces (aircraft) stall margins.

2.1.2 Sequence among other methods.

- a. General. See Part One, paragraph 5.5.
- b. Unique to this method.
 - (1) There are at least two philosophies related to test sequence. One approach is to conserve test item life by applying what are perceived to be the least damaging environments first. For this approach, generally apply the icing/freezing rain following rain tests, but prior to salt fog tests, because residual salts could impair the formation of ice. Also, apply this test prior to dynamic tests, which could loosen components.
 - (2) Another approach is to apply environments to maximize the likelihood of disclosing synergetic effects. For this approach, consider icing tests.

2.2 Selecting Procedure Variations.

This method has one procedure. However, the test procedure may be varied. Before conducting this test, complete the tailoring process by selecting specific procedure variations (special test conditions/techniques for this procedure) based on requirements documents, Life Cycle Environmental Profile, Operational Environment Documentation (see Part One, figure 1-1), and information provided with this procedure. Consider the following in light of the operational purpose and life cycle of the materiel.

2.2.1 Ice formation.

2.2.1.1 Principal causes.

A buildup of ice occurs in four principal ways:

- a. From rain, drizzle, or fog falling on materiel whose temperature is at or below freezing;
- b. From sublimation;
- c. From freezing rain or freezing drizzle falling on materiel at or near freezing, or
- d. From sea spray and splash which coats materiel when the materiel temperature is below freezing.

2.2.1.2 Types of ice. (Reference b.)

Two types of ice are commonly encountered: rime ice (opaque/granular) and glaze ice (clear/smooth). Published extremes for ice accretion may be used for calculating design and structural evaluations but are not considered practical for establishing test conditions due to the large thicknesses involved unless the test is intended to provide practical confirmation of design calculations.

- a. **Rime ice:** A white or milky and opaque granular deposit of ice formed by a rapid freezing of supercooled water drops as they impinge upon an exposed object. Rime ice is lighter, softer, and less transparent than glaze. Rime is composed essentially of discrete ice granules and has densities ranging from 0.2 g/cm³ (soft rime) to almost 0.9 g/cm³ (hard rime). Factors that favor rime formation are small drop size, slow accretion, a high degree of supercooling, and rapid dissipation of latent heat of fusion. The opposite effects favor glaze formation.
- (1) **Hard rime:** Opaque, granular masses of rime deposited chiefly on vertical surfaces by dense, supercooled fog. Hard rime is more compact and amorphous than soft rime, and builds out into the wind as glazed cones or feathers. The icing of ships and shoreline structures by supercooled spray from the sea usually has the characteristics of hard rime.
- (2) **Soft rime:** A white, opaque coating of fine rime deposited chiefly on vertical surfaces, especially on points and edges of objects, generally in supercooled fog. On the windward side, soft rime may grow to very thick layers, long feathery cones, or needles pointing into the wind and having a structure similar to that of frost.
- b. **Glaze ice:** A coating of ice, generally clear and smooth but usually containing some air pockets, formed on exposed objects by the freezing of a film of supercooled water vapor. Glaze is denser, harder, and more transparent than rime. Its density may be as high as 0.9 g/cm³. Factors that favor glaze formation are large drop size, rapid accretion, slight supercooling, and slow dissipation of heat of fusion. The opposite effects favor rime formation. Glaze occurs when rain or drizzle freezes on objects, and is clear and nearly as dense as pure ice. Since glaze ice is more difficult to remove, it is structurally a more significant factor and will be the focus of this test.

2.2.2 Configuration and orientation.

Consider the following factors:

- a. Whether or not the test item receives icing on all sides and the top.
- b. Whether or not the test item is in its deployment configuration. If required, perform tests in other configurations such as for shipping or outside storage.

2.2.3 Test temperature.

Test temperatures that may be used to produce the required environmental conditions are recommended in the test procedure. The recommended temperatures of the chamber and water may have to be adjusted for different size facilities to prevent premature freezing of the water droplets before they come in contact with the test item. However, do not use an initial test item temperature below 0°C to allow water to penetrate (cracks, seams, etc.) prior to freezing.

2.2.4 Water delivery rate.

The objective is to produce a clear, uniform coating of glaze ice. Any delivery rate that produces a uniform coating of glaze ice is acceptable. A water delivery rate of 25 mm/h is suggested in the test procedure and is based on data from previous testing.

2.2.5 Water delivery method.

Any of the following water delivery systems can be used as long as the water is delivered as a uniform spray:

- a. Nozzle arrays directing spray to the top, sides, front, and rear of the test item.
- b. Nozzle arrays that direct spray straight down onto the test item. Side-spray coverage is achieved by using wind or an additional hand-held nozzle. Minimize any wind in order to maintain uniform ice accretion.
- c. A single nozzle directing the spray over the appropriate surfaces of the test item.

MIL-STD-810F
1 January 2000

2.2.6 Droplet size.

The droplet size range may have to be adjusted for different size facilities. A fine spray in the range of 1.0 mm to 1.5 mm diameter nominal droplet size has produced satisfactory icing in some facilities.

2.2.7 Ice thickness.

Unless specifically measured data for the anticipated situation are available, the following ice thicknesses are recommended (reference c):

- a. 6mm - represents general conditions, light loading
- b. 13mm - represents general conditions, medium loading
- c. 37mm - represents heavy ground loading and marine mast loading
- d. 75mm - represents extremely heavy ground loading and marine deck loading.

2.3 Operational Considerations.

- a. Some materiel covered with ice may be expected to operate immediately without first undergoing de-icing procedures; other materiel would not be expected to operate until some form of de-icing has taken place (e.g., aircraft ailerons (flaps) prior to flight).
- b. Ice removal, if required, may include built-in ice-removal systems, prescribed means which could be expected to be employed in the field, or a combination of these.
- c. The correct operation of anti-ice systems such as pre-heated surfaces.

3. INFORMATION REQUIRED.

3.1 Pretest.

The following information is required to conduct icing/freezing rain tests adequately.

- a. General. Information listed in Part One, paragraphs 5.7 and 5.9, and Part One, Appendix A, Task 405 of this standard.
- b. Specific to this method.
 - (1) Ice thickness to be applied.
 - (2) Ice removal method(s) (if employed).
 - (3) Any variations from recommended test temperatures and droplet sizes.
 - (4) Surfaces of the test item to which ice is to be applied.
 - (5) Velocity of any wind used.

3.2 During Test.

Collect the following information during conduct of the test:

- a. General. Information listed in Part One, paragraph 5.10, and in Appendix A, Task 406 of this standard.
- b. Specific to this method.
 - (1) Record of chamber temperatures versus time conditions.
 - (2) Record of the test item temperature-versus-time data for the duration of the test.

3.3 Post-test.

- a. General. Information listed in Part One, paragraph 5.13.
- b. Specific to this method.
 - (1) Actual ice thicknesses.
 - (2) Results of required ice removal efforts.
 - (3) Initial analysis of any failures/problems.
 - (4) Type of ice developed, i.e., glaze or rime.

4. TEST PROCESS.

4.1 Test Facility.

The required apparatus consists of a chamber or cabinet together with auxiliary instrumentation capable of establishing and maintaining the specified test conditions. Use a facility equipped so that test conditions within the chamber can be stabilized soon after the test item is installed. Arrange water delivery equipment to minimize the collection of puddles/ice in the chamber. Make continuous recordings of chamber temperature measurements and, if required, test item temperatures.

4.2 Controls.

Before each test, verify the critical parameters. Ensure the nozzle spray pattern is wide enough to guarantee uniform impingement for all test wind velocities. Unless otherwise specified, if any action other than test item operation (such as opening the chamber door) results in a significant change in the test item or chamber temperature (more than 2°C), restabilize the test item at the required test temperature before continuing. If the operational check is not completed within 15 minutes, reestablish the test item temperature conditions before continuing.

4.3 Test Interruption.

- a. General. See Part One, paragraph 5.11 of this standard.
- b. Specific to this method.
 - (1) Undertest interruption. Interruption of an icing/freezing rain test is unlikely to generate any adverse effects. Normally, continue the test from the point of interruption once the test conditions have been re-established.
 - (2) Overtest interruption. Follow any interruption that results in more extreme exposure of the test item than required by the requirements document by a complete operational and physical checkout. If there are no problems, restore the test item to its pretest condition and restart the test.

4.4 Test Setup.

- a. General. See Part One, paragraph 5.8.
- b. Unique to this method.
 - (1) Clean all outside surfaces of any contamination not present during normal operation. Even thin films of oil or grease will prevent ice from adhering to the test item and change the test results.
 - (2) To facilitate measurement of ice thickness, mount depth gauges such as copper bars or tubes of an appropriate size in places where they will receive the same general waterspray as the test item. Other thickness measurement techniques may be used if they can be shown to indicate the ice thickness.

MIL-STD-810F
1 January 2000

NOTE: Since artificially produced freezing accretion rates tend to depend on the distance between the test item and spray device, for structures with large height variations such as antenna masts, place test bars at different heights.

- (3) Using chilled water (between 0° and 3°C) in the spraying system will cause a faster ice buildup rate than unchilled water.

4.5 Test Execution.

The following steps, alone or in combination, provide the basis for collecting necessary information concerning the materiel in an icing/freezing rain environment.

4.5.1 Preparation for test.

4.5.1.1 Preliminary steps.

Before starting the test, review pretest information in the test plan to determine test details (e.g., procedures, item configuration, cycles, durations, parameter levels for storage/operation, ice thickness, etc.).

4.5.1.2 Pretest standard ambient checkout.

All items require a pretest standard ambient checkout to provide baseline data. Conduct the checkout as follows:

- Step 1. Install temperature sensors in, on, or around the test item as described in the test plan.
- Step 2. Install the test item in the chamber (Part One, paragraph 5.8.1) in the required configuration and orientation, and at standard ambient conditions (Part One, paragraph 5.1).
- Step 3. Conduct a visual examination of the test item with special attention to stress areas such as corners of molded cases, and document the results.
- Step 4. Conduct an operational checkout (Part One, paragraph 5.8.2) as described in the plan to obtain baseline data, and record the results.
- Step 5. If the test item operates satisfactorily, proceed to paragraph 4.5.2. If not, resolve the problems and repeat Step 4 above.

4.5.2 Procedure I - Glaze ice.

- Step 1. Stabilize the test item temperature at 0°C (-0/+2°C).
- Step 2. Deliver a uniform, precooled water spray for 1 hour to allow water penetration into the test item crevices/openings (although a water temperature of 0 - 3°C is ideal, a water temperature of 5°C and a water delivery rate of 25 mm/h has proven satisfactory).
- Step 3. Adjust the chamber air temperature to -10°C or as specified and maintain the waterspray rate until the required thickness of ice has accumulated on the appropriate surfaces. Wind or a side spray may be used to assist accumulation of ice on the sides of the test item.

NOTE: If it is difficult to produce a satisfactory layer of glaze ice, vary one or more of the parameters as necessary, i.e., water or test item temperature, spray rate, distance between the nozzles and the test item, etc.

NOTE: It may be easier to stop spraying during the temperature reduction to facilitate temperature adjustment and to minimize frosting of test chamber refrigeration coils.

- Step 4. Maintain the chamber air temperature for a minimum of 4 hours to allow the ice to harden. Examine for safety hazards and, if appropriate, attempt to operate the test item. Document the results (with photographs if necessary).
- Step 5. If step 4 has resulted in failure or if the specification allows ice removal, remove the ice. Limit the method of ice removal to that determined in 3.1b, e.g., built-in ice removal systems, plus expedient means which could be expected to be employed in the field. Note the effectiveness of ice removal techniques used.
- Step 6. Examine for safety hazards and, if appropriate (and possible), attempt to operate the test item at the specified low operating temperature of the materiel.
- Step 7. If required, repeat steps 3 through 6 to produce other required thicknesses of ice.
- Step 8. Stabilize the test item at standard ambient conditions and perform a post-test operational check.

Step 9. Document (with photographs if necessary) the results for comparison with pretest data.

5. ANALYSIS OF RESULTS.

In addition to the guidance provided in Part One, paragraphs 5.14 and 5.17, the following information is provided to assist in the evaluation of the test results. Apply any data relative to failure of a test item to the test analysis, and consider related information such as:

- a. For materiel that must operate without ice removal: if the performance of the test item has been degraded beyond that specified in the requirements document.
- b. For materiel that requires ice removal before operation: if the performance of the test item has been degraded below the specified limits/requirements after normal ice removal efforts have been undertaken.
- c. If normal ice removal damages the materiel.
- d. If a nonapparent hazardous situation has been created.

6. REFERENCE/RELATED DOCUMENTS.

- a. AR 70-38, Research, Development, Test and Evaluation of Materiel for Extreme Climatic Conditions.
- b. Glossary of Meteorology, Edited by Ralph E. Huschke, Published by the American Meteorological Society (1959).
- c. Letter, Cold Regions Research and Engineering Laboratory, Corps of Engineers (U.S.), CECRL-RG, 22 October 1990, SUBJECT: Ice Accretion Rates (Glaze).
- d. MIL-HDBK-310, Global Climatic Data for Developing Military Products.
- e. Synopsis of Background Material for MIL-STD-210B, Climatic Extremes for Military Equipment. Bedford, MA: Air Force Cambridge Research Laboratories, 24 January 1974. DTIC number AD-780-508.
- f. NATO STANAG 4370, Environmental Testing.
- g. Allied Environmental Conditions and Test Procedure (AECTP) 300, Climatic Environmental Tests (under STANAG 4370).

MIL-STD-810F
1 January 2000

THIS PAGE INTENTIONALLY BLANK

METHOD 522

BALLISTIC SHOCK

NOTE: Tailoring is essential. Select methods, procedures, and parameter levels based on the tailoring process described in Part One, paragraph 4, and Appendix C. Apply the general guidelines for laboratory test methods described in Part One, paragraph 5 of this standard.

1. SCOPE.

1.1 Purpose.

This method includes a set of ballistic shock tests generally involving momentum exchange between two or more bodies or momentum exchange between a liquid or gas and a solid performed to:

- a. provide a degree of confidence that materiel can structurally and functionally withstand the infrequent shock effects caused by high levels of momentum exchange on a structural configuration to which the materiel is mounted.
- b. experimentally estimate the materiel's fragility level relative to ballistic shock in order that shock mitigation procedures may be employed to protect the materiel's structural and functional integrity.

1.2 Application.

1.2.1 Ballistic shock definition.

Ballistic shock is a high-level shock that generally results from the impact of projectiles or ordnance on armored combat vehicles. Armored combat vehicles must survive the shocks resulting from large caliber non-perforating projectile impacts, mine blasts, and overhead artillery attacks, while still retaining their combat mission capabilities. Reference d discusses the relationship between various shock environments (ballistic shock, transportation shock, rail impact shock, etc.) for armored combat vehicles. Actual shock levels vary with the type of vehicle, the specific munition used, the impact location or proximity, and where on the vehicle the shock is measured. There is no intent here to define the actual shock environment for specific vehicles. Furthermore, it should be noted that the ballistic shock technology is still rather limited in its ability to define and quantify the actual shock phenomenon. Even though considerable progress has been made in the development of measurement techniques, currently used instrumentation (especially the shock sensing gages) is still bulky and cumbersome to use. The development of analytical (computational) methods to determine shock levels, shock propagation, and mitigation is lagging behind the measurement technology. The analytical methods under development and in use to date have not evolved to the level where their results can be relied upon to the degree that the need for testing is eliminated. That is, the prediction of response to ballistic shock is, in general, not possible except in the simplest configurations. When an armored vehicle is subjected to a non-perforating large caliber munition impact or blast, the structure locally experiences a force loading of very high intensity and of relatively short duration. Though the force loading is localized, the entire vehicle is subjected to stress waves traveling over the surface and through the structure. In certain cases, pyrotechnic shocks have been used in ballistic shock simulations. There are several caveats in such testing. The characteristics of ballistic shock are outlined in the following paragraph.

1.2.2 Ballistic shock - momentum exchange.

Ballistic shock usually exhibits momentum exchange between two bodies or between a fluid and a solid. It commonly results in velocity change in the support materiel. Ballistic shock has a portion of its characterization below 100 Hz, and the magnitude of the ballistic shock response at a given point reasonably far from the ballistic shock source is a function of the size of the momentum exchange. Ballistic shock will contain material wave propagation characteristics (perhaps substantially nonlinear) but, in general, the material is deformed and accompanied by structural damping other than damping natural to the material. For ballistic shock, structural

MIL-STD-810F
1 January 2000

connections do not necessarily display great attenuation since low frequency structural response is generally easily transmitted over joints. In processing ballistic shock data, it is important to be able to detect anomalies. With regard to measurement technology, accelerometers, strain gages, and shock sensing gages may be used (see ref. a). In laboratory situations, laser velocimeters are useful. Ballistic shock resistance is not, in general, “designed” into the materiel. The occurrence of a ballistic shock and its general nature can only be determined empirically from past experience based on well-defined scenarios. Ballistic shock response of materiel in the field is, in general, very unpredictable and not repeatable among materiel.

1.2.3 Ballistic shock - physical phenomenon.

Ballistic shock is a physical phenomenon characterized by the overall material and mechanical response at a structure point from elastic or inelastic impact. Such impact may produce a very high rate of momentum exchange at a point, over a small finite area or over a large area. The high rate of momentum exchange may be caused by collision of two elastic bodies or a pressure wave applied over a surface. General characteristics of ballistic shock environments are as follows:

- a. near-the-source stress waves in the structure caused by high material strain rates (nonlinear material region) that propagate into the near field and beyond;
- b. combined low and high frequency (10 Hz – 1,000,000 Hz) and very broadband frequency input;
- c. high acceleration (300g – 1,000,000g) with comparatively high structural velocity and displacement response;
- d. short-time duration (<180 msec);
- e. high residual structure displacement, velocity, and acceleration response (after the event);
- f. caused by (1) an inelastic collision of two elastic bodies, or (2) an extremely high fluid pressure applied for a short period of time to an elastic body surface coupled directly into the structure, and with point source input, i.e., input is either highly localized as in the case of collision, or area source input, i.e., widely dispersed as in the case of a pressure wave;
- g. comparatively high structural driving point impedance (P/v , where P is the collision force or pressure, and v the structural velocity). At the source, the impedance could be substantially less if the material particle velocity is high;
- h. measurement response time histories that are very highly random in nature, i.e., little repeatability and very dependent on the configuration details;
- i. shock response at points on the structure is somewhat affected by structural discontinuities;
- j. structural response may be accompanied by heat generated by the inelastic impact or the fluid blast wave;
- k. the nature of the structural response to ballistic shock does not suggest that the materiel or its components may be easily classified as being in the “near field” or “far field” of the ballistic shock device. In general, materiel close to the source experiences high accelerations at high frequencies, whereas materiel far from the source will, in general, experience high acceleration at low frequencies as a result of the filtering of the intervening structural configuration.

1.3 Limitations.

Because of the highly specialized nature of ballistic shock and the substantial sensitivity of ballistic shock to the configuration, apply it only after giving careful consideration to information contained in references c and d.

- a. This method does not include special provisions for performing ballistic shock tests at high or low temperatures. Perform tests at room ambient temperature unless otherwise specified or if there is reason to believe either operational high temperature or low temperature may enhance the ballistic shock environment.
- b. This method does not address secondary effects such as blast, EMI, and thermal.

2. TAILORING GUIDANCE.

2.1 Selecting the Ballistic Shock Method.

After examining requirements documents and applying the tailoring process in Part One of this standard to determine where ballistic shock effects are foreseen in the life cycle of the materiel, use the following to confirm the need for this method and to place it in sequence with other methods.

2.1.1 Effects of ballistic shock.

In general, ballistic shock has the potential for producing adverse effects on all electronic, mechanical, and electro-mechanical materiel. In general, the level of adverse effects increases with the level and duration of the ballistic shock and decreases with the distance from the source (point or points of impact) of the ballistic shock. Durations for ballistic shock that produce material stress waves with wavelengths that correspond with the natural frequency wavelengths of micro electronic components within materiel will enhance adverse effects. Durations for ballistic shock that produce structure response movement that correspond with the low frequency resonances of mechanical and electro-mechanical materiel will enhance the adverse effects. Examples of problems associated with ballistic shock include:

- a. materiel failure as a result of destruction of the structural integrity of micro electronic chips including their mounting configuration;
- b. materiel failure as a result of relay chatter;
- c. materiel failure as a result of circuit card malfunction, circuit card damage, and electronic connector failure. On occasion, circuit card contaminants having the potential to cause short circuits may be dislodged under ballistic shock. Circuit card mounts may be subject to damage from substantial velocity changes and large displacements.
- d. materiel failure as a result of cracks and fracture in crystals, ceramics, epoxies or glass envelopes.
- e. materiel failure as a result of sudden velocity change of the structural support of the materiel or the internal structural configuration of the mechanical or electro-mechanical materiel.

2.1.2 Sequence among other methods.

- a. General. See Part One, paragraph 5.5.
- b. Unique to this method. Unless otherwise identified in the life cycle profile and, since ballistic shock is normally experienced in combat and potentially near the end of the life cycle, normally schedule ballistic shock tests late in the test sequence. In general, the ballistic shock tests can be considered independent of the other tests because of their unique and specialized nature.

2.2 Selecting a Procedure.

This method includes five ballistic shock test procedures. See paragraph 2.3.4 for the “default” approach to ballistic shock testing when no field data are available.

- a. Procedure I – Ballistic Hull and Turret (BH&T), Full Spectrum, Ballistic Shock Qualification. Replication of the shock associated with ballistic impacts on armored vehicles can be accomplished by firing projectiles at a “Ballistic Hull and Turret” (BH&T) with the materiel mounted inside. This procedure is very expensive and requires that an actual vehicle or prototype be available, as well as appropriate threat munitions. Because of these limitations, a variety of other approaches is often pursued. The variety of devices used to simulate ballistic shock is described in reference d.
- b. Procedure II – Large Scale Ballistic Shock Simulator (LSBSS). Ballistic shock testing of complete components over the entire spectrum (10 Hz to 100 kHz) defined in table 522-I and on figure 522-1 can be accomplished using devices such as the Large Scale Ballistic Shock Simulator (LSBSS) described in reference d. This approach is used for components weighing up to 500 Kg (1100 lbs), and is considerably less expensive than the BH&T approach of Procedure I.

MIL-STD-810F
1 January 2000

- c. Procedure III - Limited Spectrum, Light Weight Shock Machine (LWSM). Components weighing less than 113.6 kg (250 lbs) and shock mounted to eliminate sensitivity to frequencies above 3 kHz can be tested over the spectrum from 10 Hz to 3 kHz of table 522-I and figure 522-1 using a MIL-S-901 Light Weight Shock Machine (LWSM) adjusted for 15 mm (0.59 inch) displacement limits. Use of the LWSM is less expensive than full spectrum simulation, and may be appropriate if the specific test item does not respond to high frequency shock and cannot withstand the excessive low frequency response of the drop table (Procedure V).
- d. Procedure IV - Limited Spectrum, Medium Weight Shock Machine (MWSM). Components weighing less than 2273 kg (5000 lbs) and not sensitive to frequencies above 1 kHz can be tested over the spectrum from 10 Hz to 1 kHz of table 522-I and figure 522-1 using a MIL-S-901 Medium Weight Shock Machine (MWSM) adjusted for 15 mm (0.59 inch) displacement limits. Use of the MWSM may be appropriate for heavy components and subsystems that are shock mounted and/or are not sensitive to high frequencies.
- e. Procedure V - Drop Table. Light weight components (typically less than 18 kg (40 lbs)) which are shock mounted can often be evaluated for ballistic shock sensitivity at frequencies up to 500 Hz using a drop table. This technique often results in overtest at the low frequencies. The vast majority of components that need shock protection on an armored vehicle can be readily shock mounted. The commonly available drop test machine is the least expensive and most accessible test technique. The shock table produces a half-sine acceleration pulse that differs significantly from ballistic shock. The response of materiel on shock mounts can be enveloped quite well with a half-sine acceleration pulse if an overtest at low frequencies and an undertest at high frequencies is acceptable. Historically, these shortcomings have been acceptable for the majority of ballistic shock qualification testing.

2.2.1 Procedure selection considerations.

Based on the test data requirements, determine which test procedure is applicable. In most cases, the selection of the procedure will be dictated by the actual materiel configuration, carefully noting any gross structural discontinuities that may serve to mitigate the effects of the ballistic shock on the materiel. In some cases, the selection of the procedure will be driven by test practicality. Consider all ballistic shock environments anticipated for the materiel during its life cycle, both in its logistic and operational modes. When selecting procedures, consider:

- a. The operational purpose of the materiel. From the requirements documents, determine the functions to be performed by the materiel either during or after exposure to the ballistic shock environment.
- b. The natural exposure circumstances for ballistic shock. The natural exposure circumstances for ballistic shock are based on well-selected scenarios from past experience and the chances of the occurrence of such scenarios. For example, if an armored vehicle is subject to a mine blast, a number of assumptions must be made in order to select an appropriate test for the ballistic shock procedure. In particular, the size of the mine, the location of major pressure wave impact, the location of the materiel relative to the impact "point," etc. If the armored vehicle is subject to non-penetrating projectile impact, the energy input configuration will be different from that of the mine, as will be the effects of the ballistic shock on the materiel within the armored vehicle. In any case, condition each scenario to estimate the materiel response as a function of amplitude level and frequency content. It will then be necessary to decide to which scenarios to test and which testing is most critical. Some scenario responses may "envelope" others, which may reduce the need for certain testing such as road, rail, gunfiring, etc. In test planning, do not break up any measured or predicted response to ballistic shock into separate amplitude and/or frequency ranges utilizing different tests to satisfy one procedure.
- c. Required data. The test data required to determine whether the operational purpose of the materiel has been met.
- d. Procedure sequence. Refer to paragraph 2.1.2.

2.2.2 Difference among procedures.

2.2.2.1 Procedure I - BH&T.

Ballistic shock is applied in its natural form using live fire testing. Test items are mounted in the BH&T that replicates the full-size vehicle in its “as designed” configuration and location. If required, “upweight” the vehicle to achieve proper dynamic response. Appropriate threats (type, distance, orientation) are successively fired at the hull and/or turret. This procedure is used to evaluate the operation of actual components, or the interaction between various components during actual ballistic impacts. Also, this procedure is used to determine actual shock levels for one particular engagement, which may be above or below the ‘default’ shock level specified in table 522-I.

2.2.2.2 Procedure II - LSBSS.

LSBSS is a low cost option for producing the spectrum of ballistic shock without the expense of live fire testing. This procedure is used primarily to test large, hard mounted components at the ‘default’ shock level specified in table 522-I. It produces shock over the entire spectrum (10 Hz to over 100,000 Hz), and is useful in evaluating components of unknown shock sensitivity.

2.2.2.3 Procedure III - LWSM.

Ballistic shock is simulated using a hammer impact. The test item is mounted on an anvil table of the shock machine using the test item’s tactical mount. The anvil table receives the direct hammer impact, which replicates the lower frequencies of general threats to a hull or turret. This procedure is used to test shock mounted components (up to 113.6 kg (250 lbs)), which are known to be insensitive to the higher frequency content of ballistic shock. This procedure produces ‘partial spectrum’ testing (up to 3,000 Hz) at the ‘default’ level specified in table 522-I.

2.2.2.4 Procedure IV - MWSM.

Ballistic shock is simulated using a hammer impact. The test item is mounted on the anvil table of the shock machine using the test item’s tactical mount. The anvil table receives the direct hammer impact, which replicates the lower frequencies of general threats to a hull or turret. This procedure is used to test components up to 2273 Kg (5000 lbs) in weight which are known to be insensitive to the higher frequencies of ballistic shock. This procedure produces ‘partial spectrum’ testing (up to 1,000 Hz.) at the ‘default’ level specified in table 522-I.

2.2.2.5 Procedure V - Drop table.

Ballistic shock is simulated by the impact resulting from a drop. The test item is mounted on the table of a commercial drop machine using the test item’s tactical mounts. The table and test item are dropped from a calculated height. The table receives the direct blow at the impact surface, which approximates the lower frequencies of general threat to a hull or turret. This procedure is used for ‘partial spectrum’ testing of shock mounted components that can withstand an overtest at low frequencies.

2.3 Determine Test Levels and Conditions.

Having selected one of the five ballistic shock procedures (based on the materiel’s requirements documents and the tailoring process), complete the tailoring process by identifying appropriate parameter levels, applicable test conditions and applicable test techniques for that procedure. Exercise extreme care in consideration of the details in the tailoring process. Base these selections on the requirements documents, the Life Cycle Environmental Profile, the Operational Environment Documentation (see Part One, figure 1-1), and information provided with this method. Consider the following basic information when selecting test levels.

2.3.1 General considerations - Terminology.

In general, response acceleration will be the experimental variable of measurement for ballistic shock. However, this does not preclude other variables of measurement such as velocity, displacement, or strain from being measured and processed in an analogous manner, as long as the interpretation, capabilities, and limitations of the measurement

MIL-STD-810F
1 January 2000

variable are clear. Pay particular attention to the high frequency environment generated by the ballistic attack, as well as the capabilities of the measurement system to accurately record the materiel's responses. For the purpose of this method, the terms that follow will be helpful in the discussion relative to analysis of response measurements from ballistic shock testing.

- a. **Effective transient duration:** The "effective transient duration" is the minimum length of time which contains all significant amplitude time history magnitudes beginning at the noise floor of the instrumentation system just prior to the initial pulse, and proceeding to the point that the amplitude time history is a combination of measurement noise and substantially decayed structural response. In general, an experienced analyst is required to determine the pertinent measurement duration to define the ballistic shock event. The longer the duration of the ballistic shock, the more low frequency information is preserved. The amplitude time history magnitude may be decomposed into several "shocks" with different effective transient durations if it appears that the overall time history trace contains several independent "shock-like" events in which there is decay to near noise floor of the instrumentation system between events. Each event may be considered a separate shock.
- b. **Shock response spectrum analysis:** Reference b defines the equivalent static acceleration maximax Shock Response Spectrum (SRS) and provides examples of SRS computed for classical pulses. The SRS value at a given undamped natural oscillator frequency, f_n , is defined to be the absolute value of the maximum of the positive and negative acceleration responses of a mass for a given base input to a damped single degree of freedom system. The base input is the measured shock amplitude time history over a specified duration (the specified duration should be the effective transient duration). To some extent, for processing of ballistic shock response data, the equivalent static acceleration maximax SRS has become the primary analysis descriptor. In this measurement description, the maximax equivalent static acceleration values are plotted on the ordinate with the undamped natural frequency of the single degree of freedom system with base input plotted along the abscissa. Interpret the phrase "equivalent static acceleration" literally only for rigid lightweight components on isolation mounts.

2.3.2 Test conditions - Shock spectrum transient duration and scaling.

Derive the SRS and the effective transient duration, T, from measurements of the materiel's response to a ballistic shock environment or, if available, from dynamically scaled measurements of a similar environment. Because of the inherent very high degree of randomness associated with the response to a ballistic shock, extreme care must be exercised in dynamically scaling a similar environment. For ballistic shock, there are no known scaling laws because of the sensitivity of the response to the size of the shock and the general configuration.

2.3.2.1 Measured data available from ballistic shock.

- a. If measured data are available, the data may be processed utilizing the SRS. (The use of Fourier Spectra (FS) or the Energy Spectral Density (ESD) is not recommended, but may be of interest in special cases.) For engineering and historical purposes, the SRS has become the standard for measured data processing. In the discussion to follow, it will be assumed that the SRS is the processing tool. In general, the maximax SRS spectrum (equivalent static acceleration) is the main quantity of interest. With this background, determine the shock response spectrum required for the test from analysis of the measured environmental acceleration time history. After carefully qualifying the data, to make certain there are no anomalies in the amplitude time histories, according to the recommendations provided in reference a, compute the SRS. The analyses will be performed for $Q = 10$ at a sequence of natural frequencies at intervals of at least 1/12th octave spacing to span a frequency range consistent with the objective of the procedure.
- b. Because sufficient field data are rarely available for statistical analysis, an increase over the envelope of the available spectral data is sometimes used to establish the required test spectrum to account for variability of the environment. The degree of increase is based upon engineering judgment and should be supported by rationale for that judgment. In these cases, it is often convenient to envelope the SRS by computing the maximax spectra over the sample spectra and proceed to add a +6 dB margin to the SRS maximax envelope. **NOTE:** This approach does not apply to the default values in table 522-I.

2.3.2.2 Measured data not available from ballistic shock.

If a data base is not available for a particular configuration, use (carefully) configuration similarity and any associated measured data for prescribing a ballistic shock test. Because of the sensitivity of the ballistic shock to the system configuration and the wide variability inherent in ballistic shock measurements, use caution in determining levels. Table 522-I and figure 522-1 give 'default' values for expected ballistic shock levels when no field measurement results are available.

2.3.3 Ballistic shock qualification - Procedure I.

Ballistic Shock Qualification - Procedure I is different from the other ballistic shock methods in that the shock levels are unknown until each particular shot (threat munition, attack angle, impact point, armor configuration, etc.) has been fired and measurements have been made. The shock levels are determined by the interaction of the threat munition and the armor as well as by the structure of the vehicle. Although the levels cannot be specified in advance, this technique produces the most realistic shock levels.

2.3.4 Ballistic shock qualification - Procedures II-IV.

For Ballistic Shock Procedures II-IV, subject the test item to the appropriate ballistic shock level a minimum of three times in the axis of orientation of greatest shock sensitivity (i.e., the worst direction). Perform a functional verification of the component during/after each test. For frequencies above 1 kHz, many ballistic shock events produce similar shock levels in all three axes. If shock levels are known from previous measurements, the shock testing can be tailored appropriately. If shock measurements are not available, use steps a-g outlined below.

- a. Ensure the test item remains in place and that it continues to function during and following shocks that are at or below the average shock level specified in table 522-I. The test item must also remain in place and continue to function following shocks that are at or below the worst case shock level specified in table 522-I. Ensure materiel critical to crew survival (e.g., fire suppression systems) continues to function during and following the worst case shock.
- b. Mount the transducers used to measure the shock on the structure as near as possible to the structure mount. Take triaxial measurements at this location. If triaxial measurements are not practical, make as many uniaxial measurements as is practical.
- c. Analyze the shock measurements in the time domain, as well as the frequency domain. Calculate the SRS using a damping ratio of 5 percent of critical damping ($Q = 10$); calculate the SRS using at least 12 frequencies per octave, proportionally spaced in the region from 10 Hz to 10 kHz (e.g., 120 frequencies spaced at approximately 10, 10.59, 11.22, 11.89, 12.59, ... 8414, 8913, 9441, 10,000 Hz).
- d. For a test shock to be considered an acceptable simulation of the requirement, 90 percent of the points in the region from 10 Hz to 10 kHz must fall within the bounds listed in table 522-II.
- e. If more than 10 percent of the SRS points in the region from 10 Hz to 10 kHz are above the upper bound, an overtest has occurred (code Red). If more than 90 percent of the SRS points lie between the upper and lower bounds, the desired qualification test has occurred (code Yellow). If none of the above occurs, and more than 10 percent of the points are below the lower bound, an undertest has occurred (code Green).
- f. If the test item or its mount fails during a code Yellow or code Green shock test, redesign the materiel and/or its mount to correct the deficiency.
- g. Retest the redesigned materiel and/or its mount following the above procedure.

MIL-STD-810F
1 January 2000

TABLE 522-I. Ballistic shock characteristics.

| Average Shock | | | | Worst Case Shock | | |
|---------------------------------------|------------------------|---------------------|--------------------------------------|------------------------|---------------------|--------------------------------------|
| Max. Resonant Freq. (Hz) ² | Peak Displacement (mm) | Peak Velocity (m/s) | Peak Value of SRS ¹ (g's) | Peak Displacement (mm) | Peak Velocity (m/s) | Peak Value of SRS ¹ (g's) |
| 10 | 15 | 1.0 | 6.0 | 42 | 2.8 | 17 |
| 29.5 | 15 | 3.0 | 52.5 | 42 | 8.5 | 148 |
| 100 | 15 | 3.0 | 178 | 42 | 8.5 | 502 |
| 1,000 | 15 | 3.0 | 1,780 | 42 | 8.5 | 5,020 |
| 10,000 | 15 | 3.0 | 17,800 | 42 | 8.5 | 50,200 |
| 100,000 | 15 | 3.0 | 178,000 | 42 | 8.5 | 502,000 |

¹ SRS (Shock Response Spectrum) is Equivalent Static Acceleration for a damping ratio equal to 5 percent of critical.

² Tests involving all frequencies from 10 Hz to maximum frequency indicated.

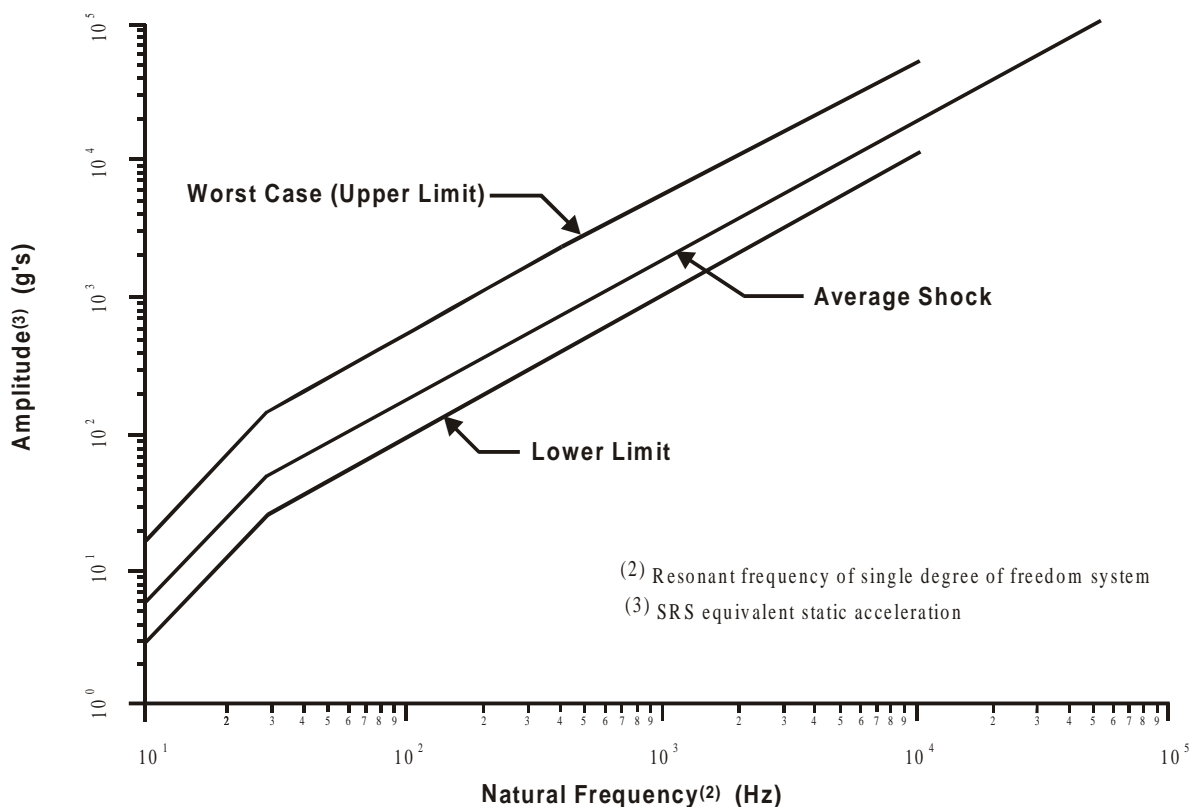

FIGURE 522-1. Shock response spectra of "default" ballistic shock limits (Tables 522-I & II).

TABLE 522-II. SRS function for shock.

| Boundary | Natural Frequency | |
|-------------|---------------------|---------------------|
| | From 10 to 29.5 Hz | From 29.5 to 10 kHz |
| Upper Bound | $SRS = 0.1702 f^2$ | $SRS = 5.020 f$ |
| Lower Bound | $SRS = 0.03026 f^2$ | $SRS = 0.89272 f$ |

2.4 Test Item Configuration.

- a. General. See Part One, paragraph 5.8.
- b. Specific to this method. Configure the test item for ballistic shock as would be anticipated during service including particular attention to the details of the mounting of the materiel to the platform.

3. INFORMATION REQUIRED.

3.1 Pretest.

The following information is required to conduct a ballistic test adequately.

- a. General. Information listed in Part One, paragraphs 5.7 and 5.9, and Appendix A, Task 405 of this standard.
- b. Specific to this method.
 - (1) Type of ballistic shock test device.
 - (2) Means of initiation of the ballistic shock test device.
 - (3) Duration of the ballistic shock.
 - (4) General materiel configuration including measurement locations on or near the materiel.
 - (5) Test system (test item/platform configuration) detailed configuration including:
 - (a) location of the ballistic shock test device;
 - (b) location of the materiel;
 - (c) the structural path between the ballistic shock device and the materiel, and any general coupling configuration of the ballistic shock device to the platform and the platform to the materiel including the identification of structural joints.

3.2 During Test.

- a. General. Information listed in Part One, paragraphs 5.10, and in Part One, Appendix A, Tasks 405 and 406 of this standard.
- b. Specific to this method.
 - (1) For test validation purposes, record deviations from planned or pre-test procedures or parameter levels, including any procedural anomalies that may occur. (See Part One, paragraph 5.10.)
 - (2) Damage to the test device or test fixture that may result in a variation of input test levels and preclude further testing until replaced or repaired.

3.3 Post-test.

Record the following post-test information.

- a. General. Information listed in Part One, paragraph 5.13 and in Appendix A, Tasks 405 and 406 of this standard.
- b. Specific to this method.
 - (1) Duration of each exposure as recorded by an instrumented test fixture or test item, and the number of specific exposures.
 - (2) Any data measurement anomalies, e.g., high instrumentation noise levels, loss of sensors or sensor mounting as a result of testing, etc.

MIL-STD-810F
1 January 2000

4. TEST PROCESS.

4.1 Test Facility.

Reference d describes four useful devices for ballistic shock testing. The most common is perhaps the drop table shock test machine utilized for shock testing of small items. For larger items that are sensitive to high frequency shock, higher frequency content and can only tolerate limited displacement, the Light Weight Shock Machine (LWSM) and Medium-Weight Shock Machine (MWSM) specified in MIL-S-901 can be useful tools for ballistic shock simulation. For large items, the Large Scale Ballistic Shock Simulator (LSBSS) utilizes an explosive charge to drive a plate to which the materiel is mounted.

- a. A BH&T device is the armor shell of a vehicle. It must contain the actual, fully functional, vehicle armor, but may not have an operational engine, suspension, gun, tracks, etc. The number of functional components and total weight of the BH&T device are adjusted to meet the requirements of each individual test effort.
- b. The LSBSS is a 22,700 kg (25-ton) structure that uses high explosives and hydraulic pressure to simulate the shock experienced by armored vehicle components and materiel (up to 500 kg (1100 lbs)) caused by the impact of enemy projectiles.
- c. The MIL-S-901 Light Weight Shock Machine uses a 182 kg (400-lb) hammer to impact an anvil plate containing the test item. Hammer drops of 1 foot, 3 feet, and 5 feet are used from two directions in three axes if the worst case axis is unknown. If the worst case axis is known and agreed, it is only necessary to test in the worst case axis.
- d. The MIL-S-901 Medium-Weight Shock Machine uses a 1360 kg (3000-lb) hammer to impact an anvil table containing the test item. Hammer height is a function of the weight on the anvil table (test item and all fixturing), and is specified in table I of MIL-S-901.
- e. Drop tables typically have a mounting surface for the test item on an 'anvil' that is dropped from a known height. In some machines, the anvil is accelerated by an elastic rope, hydraulic, or pneumatic pressure to reach the desired impact velocity. The duration and shape (half-sine or saw tooth) of the impact acceleration pulse are determined by a 'programmer' (elastic pad or hydro-pneumatic device), which in turn determines the frequency content of the shock.

4.2 Controls.

- a. For shock-mounted components, it is often necessary to determine the transfer function of the shock mounting system. Typically, a 'dummy weight' of the appropriate mass and center of gravity is mounted in place of the test item and subjected to full level shocks. The input shock and test item responses are measured to verify performance of the shock mounts. Once shock mount performance has been verified, evaluation of an operational test item can begin.
- b. Prior to subjecting the test item to the full level shock, a variety of 'preparation' shocks are typically performed. For Procedure I (BH&T), a low level 'instrumentation check' round is normally fired prior to shooting actual threat ammunition. A typical 'instrumentation check' round would be 4 to 16 oz. of explosive detonated 1 to 18 inches from the outer armor surface, and would usually produce no more than 10% of the shock expected from threat munition. For Procedure II (LSBSS), a low-level instrumentation check shot is usually fired prior to full level testing. For Procedure III (MIL-S-901 LWSM), the 1 foot hammer blow is normally used to check instrumentation, and any measurement problems are resolved prior to 3-foot and 5-foot hammer drops. For Procedure IV (MIL-S-901 MWSM), use the 'Group 1' hammer height for the instrumentation check. A similar approach is used on Procedure V, whereby a low-level drop is used to check instrumentation before conducting the full level shock.
- c. For calibration and test tolerance procedures, review the guidance provided in Part One, paragraphs 5.3.2 and 5.2, respectively.

4.3 Instrumentation.

Acceleration or velocity measurement techniques that have been validated in shock environments containing the high level, high frequency shock that characterizes ballistic shock must be used. See reference e for details. In general, ballistic shock measurements require the use of at least two different measurement technologies to cross check each other for validity. In addition, the frequency spectrum of ballistic shock content is generally so wide (10 Hz to more than 100,000 Hz) that no single transducer can make valid measurements over the entire spectrum. This broad time frequency environment provides a challenge to calibration of measurement sensors and any tolerances provided in the test plan.

4.4 Data Analysis.

Detailed analysis procedures for evaluation of the problems peculiar to ballistic shock measurement have not been established. Many (but not all) of the techniques described in reference a. are appropriate.

4.5 Test Execution.

4.5.1 Preparation for test.

4.5.1.1 Preliminary steps.

Prior to initiating any testing, review pretest information in the test plan to determine test details (e.g., procedures, test item configuration, ballistic shock levels, number of ballistic shocks):

- a. Choose the appropriate test procedure.
- b. If the ballistic shock is a calibrated test, determine the appropriate ballistic shock levels for the test prior to calibration.
- c. Ensure the ballistic shock signal conditioning and recording devices have adequate amplitude range and frequency bandwidth. It may be difficult to estimate a peak signal and arrange the instrumentation appropriately. In general there is no data recovery from a clipped signal. However, for over-ranged signal conditioning, it is usually possible to acquire meaningful results for a signal 20 dB above the noise floor of the measurement system. In some cases, redundant measurements may be appropriate - one measurement being over-ranged and one measurement ranged at the best estimate for the peak signal. The frequency bandwidth of most recording devices is usually readily available, but ensure that recording device input filtering does not limit the signal frequency bandwidth.

4.5.1.2 Pretest checkout.

All items require a pretest checkout at standard ambient conditions to provide baseline data. Conduct the checkout as follows:

- Step 1. Conduct a complete visual examination of the test item with special attention to any micro electronic circuitry areas. Pay particular attention to its platform mounting configuration and potential stress wave transmission paths.
- Step 2. Document the results.
- Step 3. Where applicable, install the test item in its test fixture.
- Step 4. Conduct an operational checkout in accordance with the approved test plan along with simple tests for ensuring the measurement system is responding properly.
- Step 5. Document the results for comparison with test data.
- Step 6. If the test item operates satisfactorily, proceed to the first test. If not, resolve the problem and restart at Step 1.
- Step 7. Remove the test item and proceed with the calibration.

MIL-STD-810F
1 January 2000

4.5.2 Procedures.

The following procedures provide the basis for collecting the necessary information concerning the platform and test item under ballistic shock. Since one of four or more ballistic shock devices may be employed, the instructions below must be consistent with the ballistic shock device selected.

4.5.2.1 Procedure I – BH&T.

- Step 1. Select the test conditions and mount the test item in a Ballistic Hull and Turret (BH&T), that may require 'upweighting' to achieve the proper dynamic response. (In general, there will be no calibration when actual hardware is used in this procedure). Select measurement techniques that have been validated in ballistic shock environments. See reference e for examples.
- Step 2. Perform a functional check on the test item.
- Step 3. Fire threat munitions at the BH&T and verify that the test item functions as required. Typically, make shock measurements at the mounting location ('input shock') and on the test item ('test item response').
- Step 4. Record necessary data for comparison with pretest data.
- Step 5. Photograph the test item as necessary to document damage.
- Step 6. Perform a functional check on the test item. Record performance data.

4.5.2.2 Procedure II - LSBSS.

- Step 1. Mount the test item to the LSBSS using the same mounting hardware as would be used in the actual armored vehicle. Select the orientation of the test item with the intent of producing the largest shock in the 'worst case' axis.
NOTE: A 'dummy' test item is typically mounted until measurements confirm that the proper explosive 'recipe' (i.e., combination of explosive weight, stand-off distance, and hydraulic displacement) has been determined to obtain the shock levels specified in table 522-I and on figure 522-1. Then mount an operational test item to the LSBSS.
- Step 2. Fire the LSBSS and verify the test item is functioning as required before, during, and after the shot.
- Step 3. Record initial data for comparison with post test data.
- Step 4. Fire three test shots at the shock level specified in table 522-I.
- Step 5. Inspect the test item; photograph any noted damage, and record data for comparison with pretest data.

4.5.2.3 Procedure III - LWSM

- Step 1. Modify the mounting for the anvil plate to restrict total travel (including dynamic plate deformation) to 15 mm (0.59 inch). Mount the test item to the LWSM using the same mounting hardware as would be used in an actual armored vehicle. Choose the orientation of the test item with the intent of producing the largest shock in the 'worst case' axis.
- Step 2. Perform a pretest checkout and record data for comparison with post test data.
NOTE: Typically, make shock measurements at the 'input' location to ensure that the low frequency shock levels specified in table 522-I and on figure 522-1 have been attained on the 5-foot drop.
- Step 3. Perform a 1 foot hammer drop followed by a performance check; record data.
- Step 4. Perform a 3-foot hammer drop followed by a performance check; record data.
- Step 5. Perform a 5-foot hammer drop followed by a performance check; record data.
- Step 6. Repeat Step 5 two more times.
- Step 7. If the worst case axis is unknown (see paragraph 4.1c), repeat steps 2-6 for each direction of each axis for a total of 18 five-foot hammer drops.

4.5.2.4 Procedure IV - MWSM

- Step 1. Modify the supports for the anvil table (by shimming the 4 table lifts) to restrict table total travel (including dynamic plate deformation) to 15 mm (0.59) inch.
- Step 2. Mount the test item to the MWSM using the same mounting hardware as would be used in an actual combat vehicle. Choose the orientation of the test item with the intent of producing the largest shock in the 'worst case' axis (see Step 7 below).

- Step 3. Perform a pretest checkout and record data for comparison with post test data.
NOTE: Typically, make shock measurements at the 'input' location to ensure that the low-frequency shock levels specified in table 522-I and on figure 522-1 have been attained on the 'Group III' drop (from MIL-S-901).
- Step 4. Perform a 'Group I height' hammer drop followed by a performance check; record data.
- Step 5. Perform a 'Group III height' hammer drop followed by a performance check; record data.
- Step 6. Repeat Step 5 two more times.
- Step 7. If the worst case axis is unknown (see paragraph 4.1c), repeat steps 2-6 for each direction of each axis for a total of 18 hammer drops at the Group III height.

4.5.2.5 Procedure V - Drop table.

- Step 1. Calculate the expected response of a shock mounted test item (or measurements from field tests may be used) and calculate a shock response spectra (SRS). Choose a half-sine acceleration pulse whose SRS 'envelopes' the expected response of the shock mounted item. Note that this approach typically results in an overttest at the lowest frequencies.
- Step 2. Hard mount the test item to the drop table.
- Step 3. Conduct a performance check and record data for comparison with post test data.
- Step 4. Test using the appropriate half sine acceleration pulse three times in each direction of all three axes (18 drops).
- Step 5. Conduct a performance check and record data for comparison with pretest data.

5. ANALYSIS OF RESULTS.

In addition to the guidance provided in Part One, paragraphs 5.14 and 5.17, and in Part One, Appendix A, Tasks 405 and 406, the following information is provided to assist in the evaluation of the test results. Analyze any failure of a test item to meet the requirements of the system specifications, and consider related information. Carefully evaluate any failure in the structural configuration of the test item, e.g., mounts, that may not directly impact failure of the functioning of the materiel but that would lead to failure in its service environment conditions.

6. REFERENCE/RELATED DOCUMENTS.

- a. Handbook for Dynamic Data Acquisition and Analysis, IES-RP-DTE012.1, Institute of Environmental Sciences, 940 East Northwest Highway, Mount Prospect, Illinois 60056
- b. Kelly, Ronald D. and George Richman, "Principles and Techniques of Shock Data Analysis," The Shock and Vibration Information Center, SVM-5, United States Department of Defense.
- c. Walton, W. Scott and Joseph Bucci, "The Rationale for Shock Specification and Shock Testing of Armored Ground Combat Vehicles", Proceedings of the 65th Shock and Vibration Symposium, Volume I, October 1994, pp. 285-293.
- d. Walton, W. Scott, "Ballistic Shock Simulation Techniques for Testing Armored Vehicle Components", Proceedings of the 64th, Shock and Vibration Symposium, Volume I, October 1993, pp. 237-246.
- e. Walton, W. Scott, "Pyroshock Evaluation of Ballistic Shock Measurement Techniques", Proceedings of the 62nd Shock and Vibration Symposium, Volume 2, pp. 422-431, October 1991.
- f. MIL-S-901, "Shock Tests, H.I. (High Impact), Shipboard Machinery, Equipment, and Systems, Requirements for."

MIL-STD-810F
1 January 2000

THIS PAGE INTENTIONALLY BLANK

METHOD 523.2

VIBRO-ACOUSTIC/TEMPERATURE

NOTE: Tailoring is essential. Select methods, procedures, and parameter levels based on the tailoring process described in Part One, paragraph 4, and Appendix C. Apply the general guidelines for laboratory test methods described in Part One, paragraph 5 of this standard.

1. SCOPE.

1.1 Purpose.

The vibro-acoustic/temperature procedure is performed to determine the synergistic effects of vibration, acoustic noise, and temperature on externally carried aircraft stores during captive carry flight. Such determination may be useful for, but not restricted to the following purposes:

- a. To reveal and correct design weaknesses (Test, Analyze and Fix (TAAF) test).
- b. To determine whether a design meets a specified reliability requirement (Reliability Demonstration test).
- c. To reveal workmanship or component defects before a production unit leaves the place of assembly (Screening test).
- d. To estimate the Mean Time Between Failure (MTBF) of a lot of units based upon the test item's time to failure of a small sample of the units (Lot Acceptance test).
- e. To determine the relative reliability among units based upon the test item's time to failure of a small sample of the units (Source Comparison test).

1.2 Application.

For captively carried stores, this method is intended primarily to test electronics and other electro-mechanical assemblies within the store for functionality in a vibro-acoustic/temperature environment. As an incidental part of the testing, thermal variation may induce changes in moisture exposure of the store and the effects of such exposure must be noted when interpreting the test result data. Typical applications include:

- a. development of a more reliable store design prior to production.
- b. assessment of the potential for satisfaction of the reliability requirement for a store.
- c. manufacturer's internal testing to assure delivery of reliable units during production.
- d. determination of the acceptance of a lot prior to delivery.
- e. determination of the relative differences in quality from two sources for establishing production buy proportions.

1.3 Limitations.

This method is not intended to provide for:

- a. An environmental design qualification test of a store or any of its individual components for functionality. (For such testing see method 500.4, Altitude; method 501.4, High Temperature; method 502.4, Low Temperature; method 503.4, Temperature Shock; method 507.4, Humidity; method 513.5, Acceleration; method 514.5, Vibration; method 515.5, Acoustic Noise; method 516.5, Shock; method 517, Pyroshock; and method 520.2, Temperature, Humidity, Vibration, Altitude).
- b. An environmental design qualification test of a store airframe or other structural components for structural integrity.

MIL-STD-810F
1 January 2000

- c. Any test to satisfy the requirements of the Life Cycle Profile except that for the combined vibration, acoustic, and temperature environments related to reliability testing.

2. TAILORING GUIDANCE.

2.1 Selecting the Vibro-Acoustic/Temperature Method.

After examining requirements documents and applying the tailoring process in Part One of this standard to determine where the vibro-acoustic/temperature environments are anticipated in the life cycle of the materiel, use the following to confirm the need for this method and to place it in sequence with other methods.

2.1.1 Effects of the vibro-acoustic/temperature environment.

Possible effects of a combination of vibration, acoustic noise, and temperature include all effects that these factors can cause separately (see methods 514.5, 515.5, and 520.2). In addition, increased stress as a result of moisture from thermal change may produce possible effects seen in methods 501.4, 502.4, 503.4, and 507.4. The combined vibration, acoustic noise, and temperature environments may interact to produce effects that would not occur in any single environment or a lesser combination of environments. Items in the discussion to follow point to significant effect mechanisms applicable to this method.

2.1.1.1 Relative importance of environmental stresses.

Not all environmental stresses contribute equally to materiel deterioration or failure. Analysis of service-use failures caused by aircraft environmental stress on the store (reference a) has identified the following four most important causes of failure:

- a. loading of the store through captive carriage,
- b. temperature,
- c. vibration, and
- d. moisture.

2.1.1.2 Other environmental stresses.

Consider the inclusion of other environmental stresses that may be important for particular materiel. In general, it is not appropriate to include comparatively rare occurrences of extreme stress levels that are better quantified in single environment methods described elsewhere in this standard. A general guideline for this determination for an individual stress is that, if a stress has a "fraction of time of occurrence" (FTO) less than 0.1 (10%) of the total time specified for the store's MTBF, the condition may be considered too rare to be included in a test described by this method. In evaluating FTO, consider all in-service use environments and use the more severe of the two. Note that the term FTO is used here in place of the more traditional probability of occurrence. FTO is defined for a level of stress as the ratio of the time the store is under the stress condition divided by the total time of observation, e.g., the store's mean time between failure. Probability of occurrence relates to the chances a stress event will occur and may not relate directly to a single specific time interval. FTO can be shown to provide an estimate of the probability distribution of the level of stress and is a more precise term. A simple example of this difference is as follows: If the stress condition is the absolute value of the acceleration at a point in the store that is above 5g's, the FTO is easily established from an auto-spectral density (ASD) estimate over a specified time interval. This implies a stationary Gaussian time history with zero mean and standard deviation as the square root of the area under the ASD estimate. The probability of occurrence relates to the number of times the 5g level is exceeded, but the total time above 5g may vary from one occurrence to the next, depending on the difference in ASD estimates and on the associated duration of each of the stationary Gaussian ASD estimates.

2.1.1.3 Operation.

Operating any materiel item produces stress that can cause failure. In the case of external aircraft stores, operation generally means providing full electrical power, which produces both thermal, electromagnetic, and electrochemical stress. Duty cycles (on/off), low and high voltage, power ripple, and voltage spikes may also be significant stresses. Even when the stress of operation is negligible, it is necessary to operate the materiel under test to detect the

presence of failure. Many failures induced by temperature and some vibration-induced failures are reversible, at least initially. As the test continues, reversible failures tend to become irreversible. Thus, it is important to conduct tests of functions while the environmental stresses are present.

2.1.1.4 Temperature.

The most severe temperature shock to internal components may come from powering the materiel when it is cold. In order to induce all the stresses related to temperature in their proper proportion, use a thermal model of the store to predict the temperatures and rates of change at several internal points under service mission profiles.

- a. Ambient temperature. The greatest variations in ambient temperature occur near the surface of the Earth. The low temperature extreme experience by a store is, in many cases, due to low ambient temperatures immediately preceding flight. This is because there is ample time for temperature soak and there is no internal power dissipation or aerodynamic heating. Hence, it is important to consider on-the-ground temperatures in determining the initial captive flight temperature. The test temperature cycle may need to include a simulated on-the-ground period in order to normalize the temperature for the next simulated mission phase; otherwise an uninterrupted sequence of simulated missions may tend to drive the average internal temperature up or down relative to real missions. NATO STANAG 2895 and MIL-HDBK-310 provide ground ambient air temperatures and their probability of occurrence for various regions. The temperatures that are cited in the two documents are those measured for meteorological purposes and do not include the heating effects of direct sunlight or cooling due to radiation into the night sky. Hence, in determining preflight temperatures, consider the effects of radiation heat transfer, and remember to convert from probability of occurrence to FTO in application.
- b. Aerodynamic heating. During captive flight, the high convective heat transfer rate will cause the surface temperature of an external store to be near that of the boundary layer. The recovery air temperature in the boundary layer depends primarily on the ambient temperature and the speed of flight. The functional dependence is:

$$T_r = T_o \theta \left(1 + r(\gamma - 1) \frac{M^2}{2} \right)$$

where:

- T_r = boundary layer recovery air temperature, °K (°R)
- T_o = sea level air temperature (standard day), 288.16 °K (518.69 °R)
- θ = ratio temperature at altitude to sea level temperature (standard day)
(varies with altitude in two altitude ranges, see method 514.5 table 514.5C-VI)
- r = 0.87, boundary layer temperature recovery factor
- γ = 1.4, atmospheric ratio of specific heats
- M = flight Mach number

Since flight at high altitude, where the ambient temperatures are lowest, is usually at higher Mach numbers (>0.80), the low temperatures are generally mitigated by aerodynamic heating. Because of the dominance of boundary layer heat transfer, radiation heat transfer can be neglected in captive flight.

- c. Power dissipation. Although the high heat transfer rate will tend to keep the surface of a store at the boundary layer recovery temperature, internal temperatures may be considerably higher due to power dissipation of electronic equipment. For this reason the duty cycle of the materiel being tested must be tailored to reflect realistic operation and it must be coordinated with the external temperature to achieve a good reproduction of the expected temperatures.
- d. Temperature gradients. The strongest temperature gradients will usually be those associated with powering the materiel when it is cold. Temperature gradients will also occur due to changes in flight speed and altitude, which change the surface temperature more rapidly than internal temperatures.

2.1.1.5 Vibration.

Vibration may cause mechanical fatigue failure of parts, abrasion due to relative motion, dislodging of loose particles that can cause electrical shorts, and degradation of electronic functions through microphonics and triboelectric noise.

MIL-STD-810F
1 January 2000

Experiments (reference b) and theoretical analysis (reference c) have shown that the relative likelihood of various failure modes changes with vibration level. In order to reproduce the service failure modes in proper proportion, it is necessary to test at several levels, keeping the fraction of time (FOT) in each level the same as predicted for the service use. The vibration spectrum may be considered to consist of two parts: the low frequency part that includes those vibrations that can be transmitted from the aircraft, through the store attachments, into the store (this is not the only source of low frequency vibration, but it is the major one), and the high frequency part that is driven almost entirely by pressure fluctuations in the boundary layer acting directly on the surface of the store. Generally, the mechanical impedance of the store attachment is such that the division between low and high frequency is between 100 Hz and 200 Hz.

- a. Low frequency vibration. The low frequency vibration primarily stresses the structure, including brackets, large circuit boards, and electromechanical devices (e.g., gyros, relays). In most cases it is driven by transmission from the aircraft; hence, input excitation through the normal attachment points with a mechanical shaker best reproduces the low frequency vibration. Use method 514.5 as a guide. Note that fluctuating aerodynamic forces may also act in the low frequency range. For control surfaces, wings, or other structure with a large area-to-mass ratio, the direct aerodynamic forces may be dominant. For this reason, the low frequency vibration of the test item cannot be regarded as a test of the structural fatigue life for wings, fins, or their attachments. In general, separate tests on components are needed to determine structural fatigue life of these components.
- b. High frequency vibration. Above the frequency at which the store attachments can transmit vibration, the vibration is driven by the boundary layer turbulence (reference d). This vibration does not contribute to failure of the basic structure, but is often a cause of failure in electronics. The characteristics of the pressure fluctuations in the boundary layer are well known (reference e). The significant aspects for external stores are:
 - (1) The pressure spectrum is almost flat, out to the highest frequencies to which stores' component parts respond (the -3dB point is about 4000 Hz). Hence, the vibration spectrum of an external store is determined almost entirely by its natural frequency responses.
 - (2) The RMS level of the pressure fluctuations, and hence the vibration, is approximately proportional to the dynamic pressure, q , which is a function of flight speed and altitude:

$$q = \frac{1}{2} \rho_0 \sigma V_a^2 M^2$$

where:

- q = dynamic pressure, kN/m² (lb/ft²)
 ρ_0 = sea level atmospheric density, 1.2251x10⁻³ kg/m³ (2.3770x10⁻³ lb sec²/ft⁴)
 σ = ratio of local atmospheric density to sea level atmospheric density (standard atmosphere)
 (varies with altitude in two altitude ranges, see method 514.5 table 514.5C-VI)
 V_a = speed of sound at sea level (standard atmosphere), 340.28 m/sec (1116.4 ft/sec)
 M = flight Mach number

Modern aircraft flight speed is typically measured in terms of calibrated air speed or Mach number. See method 514.5, Annex B, paragraph 2.6 and Annex C table 514.5C-VI for a more detailed explanation and calculation methods. Determine the proportionality between vibration level at particular points in the store and flight dynamic pressure by flight measurements. If flight data cannot be obtained, use similarity to other stores (reference f) or method 514.5, Annex C, table 514.5C-V and figures 514.5C-12, 13, and 14 as guidance.

2.1.1.6 Moisture.

Moisture, in conjunction with soluble contaminants, can result in corrosion. In conjunction with electrical power it may result in shorts. Freezing of water in confined spaces may produce mechanical stress. The test cycle should provide for diffusion of water vapor and condensation. The amount of water is generally not important for inducing failures, so humidity need not be controlled in this test. This test is not a substitute for corrosion tests, such as the salt fog test of method 509.4.

2.1.1.7 Shock.

Shock can cause failure through mechanical stress similar to that induced by vibration. Shocks that are more nearly transient vibrations (many zero crossings), such as aircraft catapult and arrested landing shock, may be included in this test. Short duration shocks such as pyrotechnic shocks associated with store or sub-munition launch, flight surface deployment, etc., are generally too difficult to reproduce at the store level. Ensure that these events that are potentially destructive to electronics are accounted for in other analyses and tests. (See method 517, Pyroshock, and method 516.5, Shock.) Analysis may show that the vibration of the test dominates the shock and in that sense the shock may be regarded as covered by the test. (See method 516.5, Shock.)

2.1.1.8 Altitude.

Barometric pressure is generally not a stress for external stores. However, variation in pressure may enhance the penetration by moisture. Reduced pressure may increase the temperature due to reduced power dissipation and there may be increased electrical arcing. Test separately for resistance to arcing. Moisture penetration will generally take place without pressure variation and, in most cases, the amount of water entrained is not important so long as it is enough to provide internal condensation. Reduced heat transfer may be realized by restricting air circulation rather than reducing ambient pressure. In general, altitude simulation is not needed in this test.

2.1.1.9 Other environments.

Although this method is intended primarily to reproduce the environmental stresses associated with the captive flight of external stores, it can be extended to include other phases of a store's life cycle provided the relative duration of those phases can be related to captive flight. For example, periods of shock and vibration representing transportation and handling have been included in some tests. Do not use environments in this test that are not expected to produce failures randomly distributed in time. For example, corrosive atmospheres and fungal growth are environments in which failures, if any, will occur only after a considerable time lapse. Store ejection shock, sand and dust, and water immersion are examples of environments for which failure either occurs or does not; these failures are associated with the event rather than being distributed in time. These environments are not appropriate for this method. Care is required in deciding which environments to include. For example, consider the case of a store that ejects sub-munitions, flares, chaff, or other items. In this case there will be a series of shock events that may be an important part of the continuing operational store environment. This may also result in open cavities in the store's external surface resulting in high intensity cavity noise for long periods.

2.1.2 Sequence among other methods.

- a. General. See Part One, paragraph 5.5.
- b. Specific to this method. This method applies to environmental stress occurring in the final phases of the store's environmental life cycle. When a single test item is subjected to this test and other environmental tests of this standard, perform this test after the tests representing earlier phases of the life cycle, but before tests representing store ejection/launch, free flight, target impact, etc.

2.2 Selecting a Procedure.

This method includes one test procedure that may be tailored to many test requirements.

2.3 Determination of Test Levels and Conditions.

Having selected this method, complete the tailoring process by identifying appropriate parameter levels and applicable test conditions and techniques for this procedure. Base these selections on the requirements documents, the Life Cycle Environmental Profile, Operational Environment Documentation (see Part One, figure 1-1), and information provided with this procedure. Consider the following when selecting test levels. Unlike other methods in this standard, this method does not contain any default values for test conditions. The combinations of vibration, acoustics, temperature, and duty-cycle environment are too complex and the variety of materiel applications too great for such detailed instruction to be given here. Instead, this method provides guidance for writing a test procedure that will be more or less unique to the materiel and test item. Annex A provides a detailed example of the development of test levels and conditions. Before attempting to apply the method, study the example in the Annex. In determination of test levels and conditions, identify the following:

MIL-STD-810F
1 January 2000

- a. Mission characterization to develop a composite aircraft/store mission profile.
- b. Mission analysis to develop:
 - (1) Mission temperature analysis for development of a mission temperature profile over time;
 - (2) Mission vibration spectra identification for development of a mission vibration profile over time¹;
 - (3) Mission operational duty cycle for functional performance of the store over time.

2.4 Test Item Configuration.

- a. General. See Part One, paragraph 5.8.
- b. Specific to this method. The configuration of the test item strongly affects test results. Use the anticipated configuration of the materiel in the life cycle profile. As a minimum consider the store captive carry service use environment.

3. INFORMATION REQUIRED.

3.1 Pretest.

The following information is required to conduct a vibro-acoustic/temperature test:

- a. General. Information listed in Part One, paragraphs 5.7, 5.8, 5.9, 5.11 and 5.12, and Part One, Appendix A, Tasks 405 and 406, of this standard.
- b. Specific to this method.
 - (1) A written, step-by-step procedure for conduct of the test that implements the test plan. Include the recording and documenting of test events and measurements. It may include other existing procedures by reference; but explicitly include any procedures related to safety.
 - (2) Quantity of items to be tested.
 - (3) Composite mission profile. Include in the detailed environmental test plan (DETP) (either directly or by reference), information used in designing the composite mission profile. Include the following:
 - (a) The particular environmental and operational variables to be controlled in the test (a minimum set includes vibration level, vibration spectrum, skin temperature, and duty cycle).
 - (b) The mission profiles, including aircraft types, store load, and percentage of occurrence of different missions.
 - (c) The climatic region of operation and the distribution of ambient temperatures.
 - (d) Derivation of the composite mission profile; including captive flight vibration measurements, temperature measurements, and thermal models.
 - (4) Test cycle. The test cycle defines the time history of the controlled and monitored variables and the performance of functional tests. The environmental test cycle is the product of a composite mission cycle and a climatic offset cycle.
 - (a) Composite mission cycle. This is a time history of the environmental and operating stresses to be imposed repeatedly at different offset climatic temperatures. All functional tests and other events such as shocks are identified in this time history. The duration, level, and other

¹ It is important to note that the specified mission vibration spectra will be spectra to be replicated during vibro-acoustic testing. In replicating the spectra, combined vibration and acoustic excitation will be employed. The specification of mission acoustic spectra is of nominal importance since the in-service acoustic environment is not replicated directly.

characteristics of each stress are defined. Include in this cycle, transitional periods to normalize temperatures between climatic offsets.

- (b) Environmental profile charts. Use a chart (either graph or table) for each of the environmental variables to be controlled or monitored during the test that shows the intended value for the variable during the composite mission cycle. These charts will be for the standard-day diurnal temperature condition.
 - (c) Climatic offset table. Prepare a table of the temperature offsets in their order of application to successive composite mission cycles. Explain in the DETP the origin of these offsets and their scope (e.g., 95% worldwide). Also, include any transitional temperature conditioning periods between composite mission cycles.
 - (d) Test control method. Include in the DETP, the method to be used in controlling environmental stresses, the location and type of sensors, the use of open-loop or closed-loop control, and the tolerances for variables. Follow the general accuracy and tolerance requirements of Part One; paragraph 5 of this standard, unless otherwise specified.
- (5) Test completion criteria. Specific statement of what constitutes a complete test (e.g., number or type of failures, number of test cycles completed, etc.).
- (6) Test log. Use a test log for written information and recording unusual events and anomalies. As a minimum, include the following:
- (a) Time that the test item(s) is installed in the test facility and the number of the first composite mission cycle thereafter.
 - (b) Calibration of instrumentation and apparatus.

3.2 During Test.

Collect the following information while conducting the test:

- a. General. Information listed in Part One, paragraphs 5.10 and 5.12, and in Appendix A, Tasks 405 and 406, of this standard.
- b. Specific to this method.
 - (1) A chronological record of events. Record all events that effect and all other events, which effect the test or may effect interpretation of test results.
 - (2) A continuous record of environmental levels. Running record of all ambient and test environmental factors and levels. For example, room temperature and humidity, acoustic horns and shaker levels, skin and component temperatures, buffet events, shaker shock events, etc.
 - (3) A record of deviations. Chronological record of all deviations from intended levels and/or durations of test environments.
 - (4) Failure interpretation/disposition. Procedures for operations after failures occur, including fix, repair, and test restart.

3.3 Post-test.

The following information is required:

- a. General. Information listed in Part One, paragraph 5.13, and in Part One, Appendix A, Tasks 405 and 406.
- b. Specific to this method.
 - (1) Test chronology. Listing of events, test interruptions, and test failures.

MIL-STD-810F
1 January 2000

- (2) Failure interpretation/disposition. Definitions of failures and failure categories. Procedures for operations after failures occur including fix, repair, and test restart.
- (3) Test item disposition. Location, condition, and planned uses of the test item (e.g., returned to the manufacturer, held for further tests, etc.).

4. TEST PROCESS.

Ensure that the apparatus used to conduct the vibro-acoustic/temperature test on a store, hereafter referred to as a "test item," includes the capability of inducing the required range of temperature and vibration while, at the same time, operating and monitoring the function of the test item. Include the following considerations.

4.1 Test Facility.

Ensure that the apparatus used to conduct the vibro-acoustic/temperature test includes the following:

4.1.1 General.

The capability to induce the required range of temperature and vibration while, at the same time, operating and monitoring the function of the test item.

4.1.2 Acoustic chamber.

Combined application of mechanical vibration and acoustic noise is generally required to reproduce the specified vibration response of test items at the monitoring points. The mechanical input through a vibration shaker system generally supplies the energy at lower frequencies (below about 100 Hz). Acoustic pressures cannot be practically controlled at frequencies below 100 Hz where transmission of vibration energy by mechanical means is practical. Acoustic energy providing vibrational energy at monitoring points becomes the major source of such vibrational energy at higher frequencies (above roughly 300 Hz) where mechanical vibration transmission through complex mechanical connections becomes impractical. The range between these frequencies is driven by a mixture of vibration and acoustics. See methods 514.5 and 515.5 for further guidance.

4.1.2.1 Acoustic chamber and acoustic source.

Ensure the chamber shape and dimensions provide for a uniform distribution of the acoustic field at frequencies above 150 Hz (reference j). The facility must be capable of producing the required levels of acoustic energy over the range 150 to 2500 Hz. While an acoustic level of 155 dB will sometimes suffice, much higher levels (up to 165 dB) are sometimes needed. This level must be attainable with the test item and other required equipment in the chamber. Because acoustic levels of these magnitudes are difficult to produce, careful planning is required to ensure that the chamber is capable of producing the required environment. Typical apparatus consists of electrically driven air modulators coupled to the chamber by exponential horns.

4.1.2.2 Vibration equipment.

To induce the lower frequency part of the vibration and to simulate exceptional dynamic events, the test item may be driven by one or more electrodynamic or electrohydraulic exciters. Ensure attachment to the exciters does not interfere with the acoustic field or significantly change the natural frequencies of the test item. With large, complex shaped, or unbalanced test items (cruise missiles, electronic countermeasures stores, munition dispensers, etc.), this is likely to require multiple exciters driving a softly suspended store through rod-and-collar drive links. For small, slender test items (air-to-air missiles, etc.) this may sometimes be accomplished by driving the test item through its usual interface with an aircraft, e.g., launcher. However, even for such small, slender test items, a softly suspended test item driven through a rod-and-collar arrangement may be needed. Typically, electrodynamic exciters are used. In cases where there are high levels of vibration required at low frequency (e.g., buffet vibration), electrodynamic exciters may not be capable of producing the required amplitudes (particularly the high velocity and displacement amplitudes). In these cases electrohydraulic exciters may be the better choice. Electrohydraulic exciters are not capable of producing the high frequencies required in typical avionics vibration tests.

4.1.3 Temperature equipment.

Ensure the range of temperatures and rate of change of the test item's skin temperature is adequate to achieve the test profile. A typical range is -40°C to $+85^{\circ}\text{C}$; the rate of change may be as high as $4^{\circ}\text{C}/\text{min}$. Temperature conditioning of the test item must be compatible with the acoustic field. In order to isolate the test item from the air in the acoustic chamber and the chamber walls, the test item may be enclosed in a thin, flexible shroud through which temperature conditioned air is ducted. This increases the thermal efficiency and permits high rates of temperature change. The shrouds must be transparent to the acoustic field. Making the shroud close fitting so as to raise the air speed around the test item enhances the heat transfer rate. Rip-stop nylon cloth has proven to be a suitable shroud material. Injection of liquid nitrogen is useful for achieving high rates of cooling. Air temperatures more extreme than the desired skin temperatures may be used to increase the heat transfer rate, but care must be taken to avoid creating excessive gradients along the surface.

4.1.4 Electrical stress.

The operation duty cycle and the functional testing of the test item will provide the basic electrical stress. Cycle the test item on and off as dictated by the mission simulation. Correlate voltage variation or other electrical parameters with temperature. Reproduce additional electrical stresses such as voltage spikes, dropouts, and ripples if they are known to occur in service.

4.2 Instrumentation.

To meet the test environment specification, acceleration, acoustic pressure, and temperature will be the measurement variables, with acceleration the primary response monitoring variable. On occasion other environment measurement variables may be employed, e.g., to measure moisture or humidity. In these cases special consideration will need to be given to the equipment specification to satisfy the calibration, measurement, and analysis requirements. All measurement instrumentation must be calibrated to traceable national calibration standards (see Part One, paragraph 5.3.2). In addition, instrumentation to measure test item function may be required. In this case, obtain and adhere to suitable calibration standards.

a. Accelerometer:

- (1) Transverse sensitivity of less than or equal to 5%.
- (2) An amplitude linearity within 10% from 5% to 100% of the peak acceleration amplitude required for testing.
- (3) A flat frequency response within $\pm 10\%$ across the frequency range 2 – 2000 Hz for piezoelectric accelerometers or DC-2000 Hz for piezoresistive accelerometers.
- (4) Accelerometer and its mounting compatible with the requirements and guidelines in reference m.

b. Microphone:

- (1) An amplitude linearity within 10% from 5% to 100% of the peak pressure amplitude required for testing.
- (2) A flat frequency response within $\pm 10\%$ across the frequency range 10 – 10000 Hz.
- (3) Microphone and its mounting compatible with the requirements and guidelines in reference m.

c. Temperature gage:

- (1) An amplitude linearity within 10% from 5% to 100% of the peak temperature amplitude required for testing.
- (2) A flat frequency response capable of detecting temperature rates at $50^{\circ}\text{C}/\text{min}$.
- (3) Temperature gage and its mounting compatible with the requirements and guidelines in reference m.

d. Other Measurement Devices. Consistent with the requirements of the test.

MIL-STD-810F
1 January 2000

- e. Signal conditioning. Use only signal conditioning that is compatible with the instrumentation requirements on the test, and that is compatible with the requirements and guidelines provided in reference m. In particular, filtering of the analog voltage signals will be consistent with the time history response requirements (in general, demonstrable sharp filter rolloff at the bandpass filter cutoff frequencies for acceleration and acoustic pressure, linear phase from DC to the filter cutoff for temperature gage), and filtering will be so configured that anomalous data caused by amplifier clipping will not be misinterpreted as response data, i.e., input to the amplifier will be filtered, but not the amplifier output. For acceleration related to shock data, filtering will require a linear phase filter from DC to the filter cutoff.
- f. Special monitoring instrumentation concerns. To control the test it is desirable to apply information from all active instrumentation in a feedback loop. Specifically, any information that indicates an out-of-tolerance test stress (e.g., temperature too high) or an out-of-tolerance test item response (e.g., excessive current draw) is cause to stop the test and initiate an investigation to determine the cause. Paragraphs 4.3.2-4.3.6 provide guidance for functional, vibrational (acoustic plus mechanical), temperature, humidity and power monitoring/control to ensure the test requirements are met.
 - (1) Functional monitoring.
 - (2) Vibration monitoring/control.
 - (a) Air modulators.
 - (b) Mechanical stimulus.
 - (3) Temperature monitoring/control.
 - (4) Humidity monitoring.
 - (5) Power monitoring.

4.3 Controls.

- a. Calibration. Ensure all environment measurement devices, e.g., accelerometers, microphones, thermal gages, have calibrations traceable as noted in Part One, paragraph 5.3.2. Verify calibration of the system with a calibration device before beginning the test procedure. If not available, provide a suitable method for verification of the appropriate response. After processing the measured response data from the calibration device and verifying that measurements are in conformance with the specifications, remove the calibration device and perform the test on the designated test item. Calibrate equipment to record the function of the test item according to the test item performance specification.
- b. Tolerances. For test validation and control of the test, use the environment measurement tolerances specified under the test procedure, and guidance provided in Part One, paragraph 5.2. In cases in which these tolerances cannot be met, establish and document achievable tolerances and ensure they are agreed to by the cognizant engineering authority and the customer prior to initiation of the test. In any case, establish tolerances within the limitations of the specified measurement calibration, instrumentation, signal conditioning and data analysis procedures. Establish tolerances on equipment to record the functional performance of the test item according to the test item performance specification.

4.3.1 Test interruption.

When monitoring or control indicates a condition unfavorable to continuation of the test while meeting the objectives of the test specification, then test interruption is appropriate.

- a. General. See Part One, paragraph 5.11 of this standard.
- b. Specific to this method.
 - (1) Undertest interruption. If an unscheduled interruption occurs that causes the test conditions to fall below allowable limits, note the immediate conditions of the test item (temperature, etc.) and the point in the composite mission cycle, and stop the test. Determine the root cause of the undertest condition (e.g., the store is not achieving the proper skin temperature because of a Temperature

Conditioning Unit (TCU) failure, or the desired vibration response levels are not being met because an acoustic modulator valve assembly has failed). Take corrective action to get all test equipment in proper working condition. Return the test item to the required conditions prior to the interruption, and continue the test from that point.

- (2) Overtest interruption. If the test item is exposed to test conditions that exceed allowable limits, give the test item an appropriate physical examination and operational check (when practical) before resuming the test. This is especially true where a safety condition may exist such as with munitions. If a safety problem is discovered, the preferable course of action is to terminate the test and reinitiate it with a new test item. (If this safety problem is not so resolved and test item failure occurs during the remainder of the test, the test results may be considered invalid.) If no problem is identified, reestablish pre-interruption conditions and continue from the point where the test tolerances were exceeded.

4.3.2 Functional monitoring.

Monitor test item functions continuously during the test. This may consist of a simplified measurement of overall performance. If so, perform a full functional evaluation at least once per environmental cycle. Full functional evaluations are recommended at both the high and low temperatures and at maximum vibration. Failures may be intermittent, irreversible, or reversible with changes in the environment. Ensure procedures for dealing with indicated failures are clearly defined. Verify functions that cannot be verified in the environmental test chamber by removing and testing the store at short intervals as compared to its expected MTBF. Note that any statistical assessment of the store reliability must take into account the test interval (reference k). Statistical test plans such as those in MIL-HDBK-781 usually assume continuous monitoring.

4.3.3 Vibration monitoring and control.

Vibration is induced both by the acoustic field and by mechanical shakers. Experimentally determine the vibration and acoustic inputs required to provide the required store response as in paragraphs a. and b. below. Once the required vibration input has been established, input control the vibration exciter(s) to this measured signal by closed loop automatic control system(s). This will provide greater test consistency than trying to control vibration exciters with feedback from response measurements. Monitor the response and when significant differences between measure and required responses are detected, stop the test and determine the cause. Looseness or wear in the vibration input train, problems with monitoring transducer mounting or wiring, and differences in response of nominally identical stores may significantly effect response (reference l). In particular, instrumented stores which have experienced many hours of severe captive flight conditions and which are used to calibrate vibration tests may be considerably less responsive than a new test store.

- a. Air modulators. The acoustic field may be generated by air modulators supplied with low-pressure 239 kPa to 446 kPa (20 to 50 psig) air. These modulators are coupled to the reverberant chamber through exponential horns. Considerable acoustic power is required, so several modulators may be needed for one chamber. Horns having a lower cutoff frequency of approximately 200 Hz may be used. The drive signal to the modulators is shaped random noise; it may be supplied from a noise generator signal that is shaped by filtering or from a pre-recorded signal. The shape of the acoustic spectrum is determined by adjusting it to produce (approximately) the same vibration response in an instrumented store as the vibration response measured in captive carry of that store. Microphones monitor the acoustic level and spectrum. Refer to method 515.5 for microphone placement, test level tolerances, and further guidance.
- b. Mechanical stimulus. The drive signal to the electrodynamic and electrohydraulic shakers is shaped random noise; it may be supplied from a noise generator signal that is shaped by filtering or from a prerecorded signal. Determine the shape of the vibration spectrum by adjusting it to produce the same vibration response in an instrumented store as the vibration response measured in the captive carry environment of that store. Adjust the acoustic input first and maintain it during compensation of the shaker drive signal. After the shaker drive signal has been compensated so as to reproduce the desired response vibration, record the vibration spectra and levels at the shaker attachments to the store as secondary standards to be used during the test. During the test, monitor vibration level and spectra with accelerometers at these points along with the store response control points. Monitor these signals throughout the test. For closed loop control of the shakers use the vibration as measured at the

MIL-STD-810F
1 January 2000

shaker/drive system interface. When the shakers are used only to provide the low frequency portion of the vibration spectrum, closed loop control may not be necessary. Refer to method 514.5 for test level tolerances and further guidance.

4.3.4 Temperature monitoring and control.

The temperature that defines the temperature test cycle is the store skin temperature that is measured and used for feedback control during the test. The air temperature may be driven to more extreme values (as much as 20°C beyond the store range) in order to increase the rate of transfer. Monitor the air temperature separately in order to avoid values outside this range. In developing the temperature cycle, measure the store skin temperature at several points to ensure even distribution of the temperature.

4.3.5 Humidity monitoring.

Although humidity is not a controlled variable for Procedure I, the ducted airstream may be monitored for moisture content, either by dewpoint or relative humidity sensing. Moisture can collect on a store's surface when it has reached and holds a cold temperature that is below the dewpoint of warmer air following in the mission cycle. This is a normal and expected condition.

4.3.6 Power monitoring.

Continuously monitor all electrical and other power inputs (e.g., hydraulic, compressed air) whether or not they are modified to simulated mission conditions. This monitoring provides an immediate indication of many types of failures and, with automatic controls, may serve to limit secondary failures.

4.4 Data Analysis.

- a. Use an analog anti-alias filter configuration on all digitized signals that will:
 - (1) not alias more than a five percent measurement error into the frequency band of interest.
 - (2) have linear phase-shift characteristics for the temperature gage and acceleration shock from DC to the upper band edge.
 - (3) have a uniform passband to within one dB across the frequency band of interest (see paragraph 4.2).
- b. In subsequent processing of the data, use any additional digital filtering that is compatible with the anti-alias analog filtering. In particular, additional digital filtering must maintain phase linearity for processing temperature gage data and any acceleration shock data.
- c. Analysis procedures will be in accordance with those requirements and guidelines provided in reference m. If anomalies are detected, discard the potentially invalid measured response time history data.

4.5 Test Execution.

4.5.1 Preparation for test.

- a. General. See Part One, paragraph 5.8.
- b. Unique to this method. Verify that environmental monitoring and measurement sensors are of an appropriate type and properly located to obtain the required test data.

4.5.2 Pretest checkout.

The following steps describe in detail the pretest set-up and cycle check procedure. The purpose of the pretest set-up is to provide a level of confidence that the test specification can be met on a test item. In general, this pretest checkout will require adjustment of the vibration sources to provide the best reproduction of the in-service vibration. Vibration response is subject to the following three sources of error: spatial, spectral, and amplitude. Since it may not be possible to minimize all of these errors simultaneously, compromises between the three kinds of error must be based on technical analysis and judgement. To better define and understand the cause behind the source of errors, each error will be described briefly along with potential corrective measures to reduce the error. It is important to

note that both the in-service measured and laboratory replicated vibro-acoustic fields are spatially non-homogeneous and highly random.

- a. Relative spatial acceleration amplitude. Because the in-service acoustic and vibration environment result from many sources that cannot be replicated in the laboratory, relative vibration levels at different locations within the test item may not correspond with measured relative vibration levels of the store at the same locations in service. Reduction of this error may require relocation of attachment shakers, use of multiple shakers, a reorientation with respect to the acoustic field (from directional horns), or selective application of acoustic damping material. In addition, the effectiveness of the acoustic field in inducing vibration may vary with the air temperature within the shrouds surrounding the test item. In general, the test set-up provides fewer degrees of freedom for exciting the test item than the degrees of freedom available for the store in service. It is important to note that cross spectra are not usually specified from in-service measured data, nor are they considered a control parameter for the test. To some extent, the input excitation from various sources is assumed to be uncorrelated.
- b. Spectral shape error. Because the in-service acoustic and vibration environment comes from many sources that cannot be replicated in the laboratory, the spectral shape at different locations within the test item may not correspond with the spectral shape of the test item at the same locations in service. This may be corrected by changing the spectrum of the acoustic and/or shaker drive signals or it may require changing the method of supporting the test item. Since cross spectra are not usually specified from in-service-measured data and are not considered a control parameter for the test, only limited correction may be possible.
- c. Amplitude error. For stationary random data, generally the amplitude distribution is assumed to be Gaussian. However, for in-service measured data, the distribution may be non-Gaussian – particularly for high-level maneuver events. The test setup should check the test item amplitude distribution to assure that it matches the in-service measured amplitude distribution. This means that particular care must be given to inherent shaker control system amplitude limiting, e.g., three sigma clipping. For replication of a given autospectral density estimate with Gaussian amplitude distribution, ensure the shaker control system truncation is at a value greater than three times the RMS level (because of the long test durations it is important to have accelerations that exceed three times the RMS level). In general, to replicate an autospectral density estimate with a non-Gaussian amplitude distribution, specialized shaker control system software is required.

4.5.3 Test setup and cycle check procedure.

- Step 1. Using an instrumented test item (not necessarily operable), assemble the test item and environmental apparatus into the planned configuration. If the planned test is based on in-service measured values, it is important that the sensors and their locations be identical to those used in these measurements. It is highly desirable that the identical test item used in the in-service measurements, with its instrumentation intact, be used in the test setup.
- Step 2. Install and calibrate all sensors. Concurrently, test the function of any automatic alarm or abort mechanisms.
- Step 3. Apply and adjust the acoustic stimulus to the minimum level. Verify the levels and spectral shape. Apply higher levels in steps until the required maximum is reached. Adjust the spectral shape as required at each level.
- Step 4. Apply the adjusted acoustic stimulus at the lowest required level. Apply an arbitrary, low-level vibration stimulus. Measure vibration response and iteratively adjust the vibration drive signal to achieve the required responses.
- Step 5. Adjust both the acoustic and vibration stimuli to their maximum levels. Adjust the vibration drive signal and, if necessary, the acoustic drive signal until the highest required levels of vibration response are achieved.
- Step 6. Adjust acoustic and vibration stimuli to each of the required intermediate levels and measure the responses. If the responses at each level are reasonably close (engineering judgement required) to the required levels, maintain the calibrations for the highest response level and iterate to the other levels by changing the overall levels of the drive signals (accuracy of the simulation is more

MIL-STD-810F
1 January 2000

important at the higher levels). If response variation is strongly non-linear with the stimulus level, establish calibrations for each level.

- Step 7. Apply the maximum temperature stimulus to the store. Adjust the temperature controller and ducting to achieve the desired skin temperatures and rates of change. Ensure that the distribution of temperature values over the skin is within tolerances as determined from the thermal model. Ensure that required temperature rates-of-change can be achieved.
- Step 8. Conduct a composite mission profile cycle, including power on/off and functional tests. Measure skin temperatures and correct any problems. Ensure that temperature rate-of-change requirements can be met. Repeat as necessary.
- Step 9. Run a composite mission temperature cycle and duty cycle at the highest offset and another at the lowest offset. Measure the skin temperatures and correct any problems. Repeat as necessary.
- Step 10. Place an operable test item into the test setup. Repeat steps 1 and 2 if this is a test item not previously subjected to those steps.
- Step 11. Provide power to the test item as required and conduct a test of its function.
- Step 12. Repeat step 11 with vibration applied, under high temperature and then under low temperature.

4.5.4 Procedure.

The following general procedure will vary depending on the test type conducted as shown in table 523.2-I

- Step 1. Prepare the test item in its test configuration as described in paragraph 4.5.3.
- Step 2. Verify the functional status of the test item.
- Step 3. Start the test using conditions specified in the test plan developed from test tailoring guidelines.
- Step 4. Conduct the test and monitor the functional status of the test item per paragraph 4.5.3.
- Step 5. If a test item failure occurs, analyze and document test results in according with paragraph 5.
- Step 6. If a test interruption occurs, proceed according to the procedure called out in paragraph 4.3.1.
- Step 7. Continue the test until termination criteria are met according to the procedure called out in paragraph 3.1.b(5). Document the results for comparison with pretest data.

5. ANALYSIS OF RESULTS.

In addition to the guidance provided in Part One, paragraphs 5.14 and 5.17, and Part One, Appendix A, Tasks 405 and 406, the following information is provided to assist in the evaluation of the test results. If the test item failed the test, consider the following categories during analysis of results of this method:

- a. Stress. If a failure occurred, what the immediate physical mechanism of failure may have been, e.g., fatigue, short circuit by particulate, etc.
- b. Loading mechanism. Determine the physical loading mechanism that led to failure and the total time or number of cycles to failure (e. g., structural dynamic resonant modes, mode shapes, stress distribution, static deformation due to temperature distribution, incursion of moisture, etc.).
- c. Responsibility. Whether or not the failure was in a contractor or government furnished part of the store; was the test being performed properly, or was there a test error, e.g., out of tolerance test conditions, which caused the failure.
- d. Source. Whether or not the failure was due to workmanship error, a design flaw, a faulty part, etc. This is actually an inverted way of deciding what corrective action is appropriate, since extraordinary workmanship or high-strength parts can overcome design flaws and designs can be changed to eliminate workmanship errors and/or to work with weaker parts.
- e. Criticality. Whether or not the failure would have endangered friendly forces, prevented tactical success, or required repair before delivering the store.

6. REFERENCE/RELATED DOCUMENTS

- a. A. Dantowitz, G. Hirshberger, and D. Pravidlo, "Analysis of Aeronautical Equipment Environmental Failures", Air Force Flight Dynamics Laboratory, TR-71-32, May 1971.

- b. D. B. Meeker and Allan G. Piersol, "Accelerated Reliability Testing Under Vibroacoustic Environments", in Reliability Design for Vibroacoustic Environments, American Society of Mechanical Engineers AMD Vol-9, New York, NY, 1974.
- c. R.G. Lambert, "Accelerated Fatigue Test Rationale", General Electric Co., NY, March 1980.
- d. David Alan Bies, "A Review of Flight and Wind Tunnel Measurements of Boundary Layer Pressure Fluctuations and Induced Structural Response", NASA CR-626, Bolt Beranek and Newman Inc., for NASA Langley Research Center, Oct 1966.
- e. Jack M. Graham, "Summary of Missile Vibration Levels During Straight and Level Flight on Various Aircraft", Pacific Missile Test Center, Point Mugu, CA, EM-1030-008, August 1984.
- f. Michael G. Hatcher and James R. Bautch, "PRAT Thermal and Vibration Profile Development", Sverdrup Technology Inc. for Aeronautical Systems Division, Eglin AFB, January 1992.
- g. U.S. Standard Atmosphere, 1976.
- h. D. F. Rex ed. "World Survey of Climatology", Elsevier, NY, 1969.
- i. Sharon A. Ogden, "A Mathematical Method for Determining Laboratory Simulation of the Captive Flight Vibration Environment", Proceedings of the 48th Shock and Vibration Symposium, Huntsville, AL, 1977.
- j. Terry Elliott, "Design Parameters of Reverberant Acoustic Chambers for Testing Air-Carried Missiles", TM-81-15, Pacific Missile Test Center, Point Mugu, CA, March 1981.
- k. Terry Elliott, "Impact of Periodic Functional Testing on Sequential Test Plans", TP-82-25, Pacific Missile Test Center, Point Mugu, CA, May 1982.
- l. Michael T. Bunij, "SIDEWINDER Manufacturer Dependent Vibration Response Investigation", Pacific Missile Test Center, Point Mugu, CA, June 1989.
- m. Handbook for Dynamic Data Acquisition and Analysis, IES-RP-DTE012.1, Institute of Environmental Sciences and Technology, 940 East Northwest Highway, Mount Prospect, Illinois 60056.
- n. MIL-HDBK-310, Global Climatic Data for Developing Military Products. 23 June 1997.
- o. NATO STANAG 2895, Extreme Climatic Conditions and Derived Conditions for Use in Defining Design/Test Criteria for NATO Forces Materiel.
- p. MIL-HDBK-781, Reliability Test Methods, Plans, and Environments for Engineering, Development, Qualification, and Production, Handbook for, 1 April 1996.
- q. Mission Environmental Requirements Integration Technology (MERIT), Final Report (draft), 15 September 1996, McDonald Douglas Aerospace

MIL-STD-810F
1 January 2000

TABLE 523.2-I. Typical applications.

| TEST TYPE | PURPOSE | APPLICATION | TYPE OF INFORMATION REQUIRED | |
|-------------------------------|---|---|---|--|
| | | | FAILURE MODES | TIME TO FAILURE |
| Test, Analyze, and Fix (TAAF) | Reveal and correct design weaknesses | Development of a more reliable design prior to production. | Essential to induce potential service failures. | Not important |
| Reliability Demonstration | Show whether or not a design meets the specified reliability. | Start of production is usually based on a successful reliability demonstration. | Important only if the demonstration is unsuccessful. | Essential. |
| Debugging or Screening | Reveal workmanship or component defects before a production unit leaves the factory, i.e., while repair is cheap. | Part of the manufacturer's internal testing to assure delivery of reliable units during production. | Essential to induce failures in defective areas; such failures should not then appear in service. | Not important. |
| Lot Acceptance | Estimate the MTBF of the lot units from the time to failure of a small sample. | Determination as to whether the lot is of acceptable quality. | Important only if the lot is rejected. | Essential that successive lot measures be consistent and comparable. Baseline similarity to service MTBF is desirable. |
| Source Comparison | Determine the relative reliability of units from the time to failure of a small sample. | Determination as to which of two sources should get the larger share of a production buy. | Important for improvements at the poorer source. | Only consistency comparability is essential. |

ANNEX A

PHILOSOPHY OF TESTING, VIBRO-ACOUSTIC/TEMPERATURE TEST PROFILE DEVELOPMENT

1. SCOPE.

1.1 Purpose.

This annex provides an example of the development of a Vibro-Acoustic/Temperature test profile.

1.2 Application.

Information in this annex is designed to provide some, but not necessarily all, of the details that must be considered in developing a Vibro-Acoustic/Temperature test profile. Information included here should allow the practitioner to develop the test profile for any of the possible test types provided in table 523.2-I.

2. DEVELOPMENT.

2.1 Background.

In order to ensure that the failures occurring in a test are typical of in-service use, it is important to reproduce the service stress distribution. The service stress distribution is the set of stresses in the combinations, levels, and duration imposed by the in-service missions. The procedure reproduces the levels, durations, and combinations of temperature, vibration, and acoustic noise in the same relative proportions as the in-service missions.

2.2 General.

Military aircraft service use may be described by a set of missions and the relative frequency of occurrence of each mission as illustrated in table 523.2A-I. Each mission is defined by the type of stores carried and a mission flight profile. The mission flight profile is an idealized mission history that describes altitude, speed, and various events (e.g., air combat, gunfire, refueling) as functions of time. From the mission profiles and climatic data, derive corresponding mission environmental profiles. Use data from instrumented flights in this derivation, if available. Once the mission environmental profiles are derived, they can be combined into a composite mission profile. The composite mission profile is a sequence of environments in which the various stresses and combinations of stresses occur in (approximately) the same proportion as in all of the mission environmental profiles weighted according to their relative frequency of occurrence. The composite mission profile also includes the effects of climatic temperatures according to their relative frequency. However, the composite mission profile must be short enough to be repeated many times (at least five times is recommended) within the expected time-to-failure of the store being tested. This may require that extreme environments (particularly extreme temperatures) not be included, since keeping them in proper proportion might result in too long a composite mission. Typically, the range of stresses included is between the 5th and 95th percentile.

2.3 Mission Characterization.

The first step in developing the composite mission profile is to determine the types of aircraft and mission flight profiles that will employ the store. The mission flight profiles may be described in terms of altitude and Mach number with annotation of events. A tabulated mission phase analysis or mission profile description is shown in table 523.2A-II. A corresponding graphical representation of this mission is shown on figure 523.2A-1. The relative frequency of occurrence of the various missions must also be determined. This may be tabulated as shown in table 523.2A-I. In determining the relative frequency with which the store will be carried on various missions, it may be necessary to consider some state of hostility. Experience has shown that weapons that would be expended on their first flight in conflict may be subjected to many flights during a time of high international tension in which there is no combat. Choose the most stressful, yet realistic, mix of missions for simulation. Generally, it is not desirable to

MIL-STD-810F
1 January 2000
ANNEX A

average together relatively benign missions with relatively stressful ones if a store will experience only one or the other during its service life. For each aircraft type and mission, determine the carriage location of the store to be tested, as well as the location of other stores that may affect it. Stores located ahead of or adjacent to a given store will cause an increase in the turbulence-induced vibration of that store. Ejection of nearby stores may also induce dynamic loads. Also, note any geographic or other conditions that would influence the mission (e.g., a store carried only by carrier-based aircraft will not experience as wide a range of preflight temperatures as one carried by land-based aircraft).

2.4 Mission Analysis.

Rather than deriving store environments such as vibration directly from the mission profiles, first recast the mission profiles in terms of the variables which directly affect the store, but which do not depend on the store's response. These variables are initial temperature, recovery air temperature, and dynamic pressure. It is assumed that the store's temperature and vibration are a function of these primary variables.

2.4.1 Mission temperatures.

Standard-day recovery air temperatures may be calculated from the equation in paragraph 2.1.1.4 and method 514.5, Annex C, table 514.5C-VI, given the flight speed and pressure altitude (h) (standard atmosphere). Table 514.5C-VI can also be used to convert various measures of air speed to Mach number. The temperature profile for a single mission type is provided on figure 523.2A-2. For a composite mission, figure 523.2A-4 displays the skin temperature versus the elapsed mission time.

2.4.2 Mission vibration.

- a. Both the frequency spectrum shape and spatial distribution of store vibration in captive flight are almost independent of the flight condition. Exceptions are increased low frequency vibration during buffeting maneuvers and, in some cases, increased high frequency vibration in supersonic flight. In general, boundary layer fluctuating pressures are proportional to the dynamic pressure (q) of the flight condition. The store vibration is the dynamic response of the store to these pressures and is also proportional to q . The vibration spectrum rms level (grms) is proportional to q , and the acceleration spectral density (G) at any frequency is proportional to q^2 . If vibration levels ($grms_{ref}$, G_{ref}) are defined for a single flight condition (q_{ref}), this proportionality can be used to approximate vibration levels throughout the flight envelope as follows:

$$\frac{grms}{grms_{ref}} = \frac{q}{q_{ref}} \quad \text{and} \quad \frac{G}{G_{ref}} = \left(\frac{q}{q_{ref}} \right)^2$$

where:

q = dynamic pressure, kN/m^2 (lb/ft^2)

grms = spectrum rms vibration level, g

G = acceleration spectral density, g^2/Hz

The area under the $G(f)$ curve is the square of the grms level

- b. Usually the reference condition is taken to be subsonic carriage on the least stressful aircraft station (wing pylon with no adjacent stores). Using this reference, determine the q versus time profile for each mission and construct a histogram representing the proportion of time the store is at a q level. This summarizes the expected vibration experience of the store. For stores for which measured vibration data are not available, the levels can be estimated by considering similar stores, with tailoring criteria provided in method 514.5 and/or Mission Environmental Requirements Integration Technology (MERIT). MERIT is an Air Force developed software package for defining aircraft external store environmental life cycles from manufacture through expenditure. It includes a very extensive database of both climatic and induced environments. Reference e is a summary for various air-launched missiles.
- c. For the missions where the store is carried on stations other than the least stressful station, adjustment factors may be needed. These factors typically account for cases where stores are carried side by side,

behind other stores or in other special configurations. Measured data are the best source for these factors. Method 514.5 and MERIT also provide guidance.

- d. Vibration of a store is the dynamic response of the store to the fluctuating pressure and aircraft transmitted environments. This is broken down into definitions of the motions of key structural points of the store. The vibration environments of materiel located in the store are the local store vibration responses. The test consists of exciting the store with arbitrary levels of vibration and acoustics, and tailoring these inputs to achieve the defined store responses.
- e. For the exceptional cases (aircraft buffet, catapult launch, arrested landing, gunfire, etc.), determine vibration/shock level, spectrum, and other characteristics. Quantify the occurrences of the exceptional vibration/shock conditions in terms of duration and mission time, so they can be reproduced in the proper proportions and at the proper times in the test cycle. Measured data are even more important here, but method 514.5 and MERIT do contain guidance both for interpreting measured data and estimating levels when necessary. Method 519.5 contains guidance on estimating gunfire-induced vibration.

2.4.3 Test temperature profile.

The test temperature profile will be the product of two parts: one that simulates the range and variation of temperature due to the missions, and another that simulates the climatic effects:

- a. To determine the mission simulation part, begin with a sequence of skin temperatures corresponding to a few of the most common mission(s) strung together. Use a sequence that is no longer than one fortieth (1/40) of the store MTBF. It is usually convenient to make it a factor of 24 hours (e.g., 6 hrs or 8 hrs) since the test will be run around-the-clock. Use this skin temperature as an input to the store thermal model and determine the histograms of the internal temperature. These must be the responses after many cycles (the "steady state" responses). Compare these to the histograms for all the missions. Adjust the test sequence to achieve approximate agreement between the temperature histograms, both on the skin and internally. In this adjustment, keep the number and rate of temperature changes roughly the same as in the actual missions. It will usually be necessary to introduce a period of simulated on-the-ground time into the cycle in order that each simulated flight period start with the store at the appropriate uniform temperature. The temperature during the simulated on-the-ground time may be elevated or reduced in order to speed up the stabilization of internal temperatures. This initial temperature will be shifted each cycle to simulate the effect of climatic temperature variation.
- b. Climatic effects are included by repeating the simulated flight cycle with temperatures shifted up or down by offset values which are constant over one cycle, but which differ from cycle to cycle (see table 523.2A-III). Successive cycles have the temperature raised or lowered by an amount that represents a colder or hotter than standard day. Ensure the number of different offsets is at least eight. The upper bound on the number of offsets is determined by the requirement that the overall cycle must be shorter than one fifth of the MTBF. The value of the N offsets is chosen to be the midpoints of the N equiprobable intervals of the climatic temperature distribution as shown on figure 523.2A-3. For worldwide, day and night operations, the climatic variation below 10 km is well approximated by a Gaussian distribution; at ground level; the mean is 12°C and the standard deviation is 15°C (reference f). (This includes variation of location as well as season.) At altitude, the mean temperature is lower, but the standard deviation is about the same (references f and g) over most of the globe. Near the poles and the equator, the variation at altitude is considerably less (reference h). For eight offsets, the temperatures would be as shown in table 523.2A-III. Stair-step the sequence of offsets in the test cycle up and down as indicated by the step number. Figure 523.2A-5 displays a climatic set plan where test item skin temperature is a function of elapsed test time. This reduces the duration required between offsets to normalize the store temperature for the next offset. It is desirable to minimize this duration since it does not count in measuring the store MTBF and hence decreases the test efficiency.

2.4.4 Test vibration profile.

Ensure the test vibration profile produces the same histogram of store response levels as that derived from the mission analysis. Analyses assuming power function fatigue damage indicate that three to five different vibration levels are usually enough (reference i). Use the same mission sequence used for the initial temperature cycle to

MIL-STD-810F
1 January 2000
ANNEX A

generate a vibration level test cycle. This can then be adjusted to achieve the correct overall histogram. Maintain correlation between vibration and temperature (usually high vibration level goes with high temperature) as in the actual missions. Insert the exceptional vibration events into the test cycle with proportionate duration, and in realistic combination with the temperature and the straight and level vibration. Usually it is desirable to test the function of the store under the more severe part of the test environment, since that is the most likely to reveal reversible failures. In service, high levels of vibration, such as those due to buffet, usually occur over several very short time intervals, on the order of a few seconds. It may be desirable to conjoin all the high level vibration corresponding to a few mission-hours into a single interval in order to allow time for a complete test of the store's function during the high level vibration. Figure 523.2A-6 displays dynamic pressure, q , in terms of absolute pressure, P_a , versus elapsed mission time for a composite mission.

2.4.5 Operational duty cycle.

Consider the operational duty cycle of the store in the temperature test design since power dissipation is a source of heat. Additionally, arrange it to allow functional test of the store during stressful parts of the cycle, as well as benign parts. If possible, test the store at low and high temperature extremes, during or immediately after high level vibration and at the beginning of each cycle.

3. TEST CONFIGURATION.

Figure 523.2A-7 is a schematic of the arrangements of a typical set of apparatus for performing a vibro-acoustic/temperature test. This arrangement consists of a control room that may be remotely located from a hardware test chamber termed an acoustic cell. The electrodynamic or electrohydraulic shakers are hidden under the test items.

TABLE 523.2A-I. Relative frequency of occurrence of mission types.

| MISSION TYPE | AIRCRAFT TYPE | % OF SORTIES |
|--------------------------|---------------|--------------|
| 1. Patrol Mission I | Fighter A | 50 |
| | Fighter B | 30 |
| 2. Patrol Mission II | Fighter A | 20 |
| | Fighter B | 20 |
| 3. Strike Escort Mission | Fighter A | 30 |
| | Fighter B | 30 |
| 4. Strike Mission | Fighter B | 20 |

TABLE 523.2A-II. Mission phase analysis (Fighter B, strike mission).

| MISSION PHASE | MACH NUMBER | ALTITUDE (km) | DURATION (min.) | ADDITIONAL FACTORS | DUTY CYCLE OF STORE |
|-----------------|-------------|---------------|-----------------|--------------------|---------------------|
| Takeoff & Climb | | | | Catapult Shock? | Off to Ready |
| Cruise | | | | | Ready |
| Refuel | | | | | Ready |
| Ingress | | | | | On (Radiate) |
| Attack | | | | Buffet? | Ready |
| Return | | | | | Ready |
| Refuel | | | | | Ready |
| Descend & Land | | | | Landing Shock? | Off |

TABLE 523.2A-III. Temperature offsets.

| STEP | PERCENTILE | OFFSET | GROUND TEMPERATURE |
|------|------------|---------|--------------------|
| 3 | 6.25 | -30.8°C | -18.8°C |
| 2 | 18.75 | -13.3°C | -1.3°C |
| 4 | 31.25 | -7.2°C | 4.8°C |
| 1 | 43.75 | -2.4°C | 9.6°C |
| 5 | 56.25 | +2.4°C | 14.4°C |
| 8 | 68.75 | +7.2°C | 19.2°C |
| 6 | 81.25 | +13.3°C | 25.5°C |
| 7 | 93.75 | +30.8°C | 43.0°C |

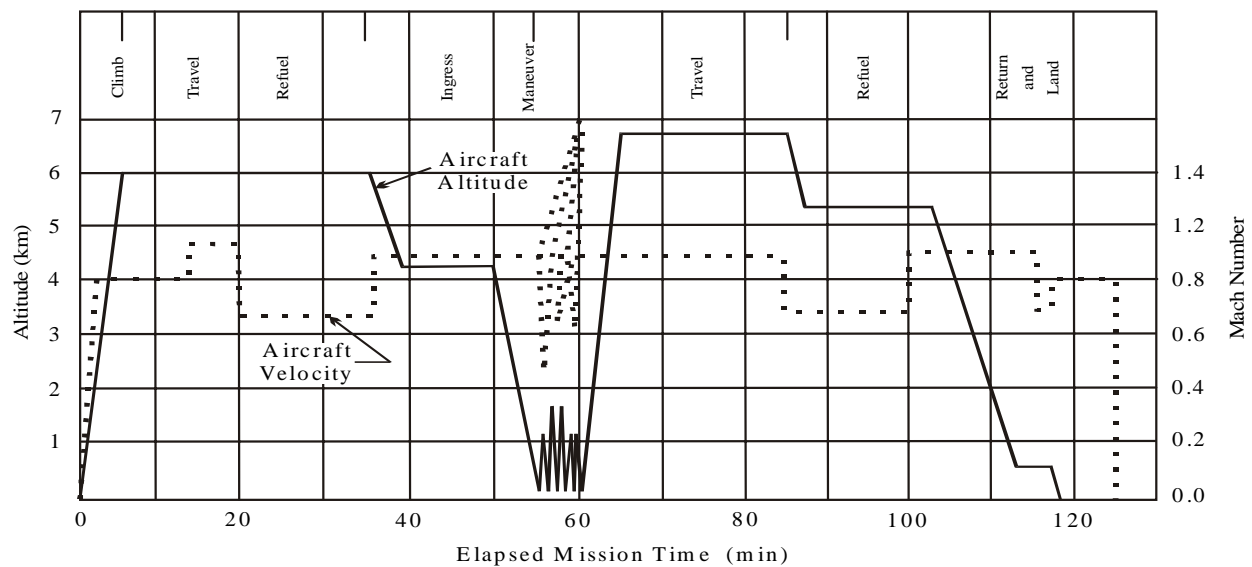

FIGURE 523.2A-1. Typical aircraft operational mission profile.

MIL-STD-810F
 1 January 2000
 ANNEX A

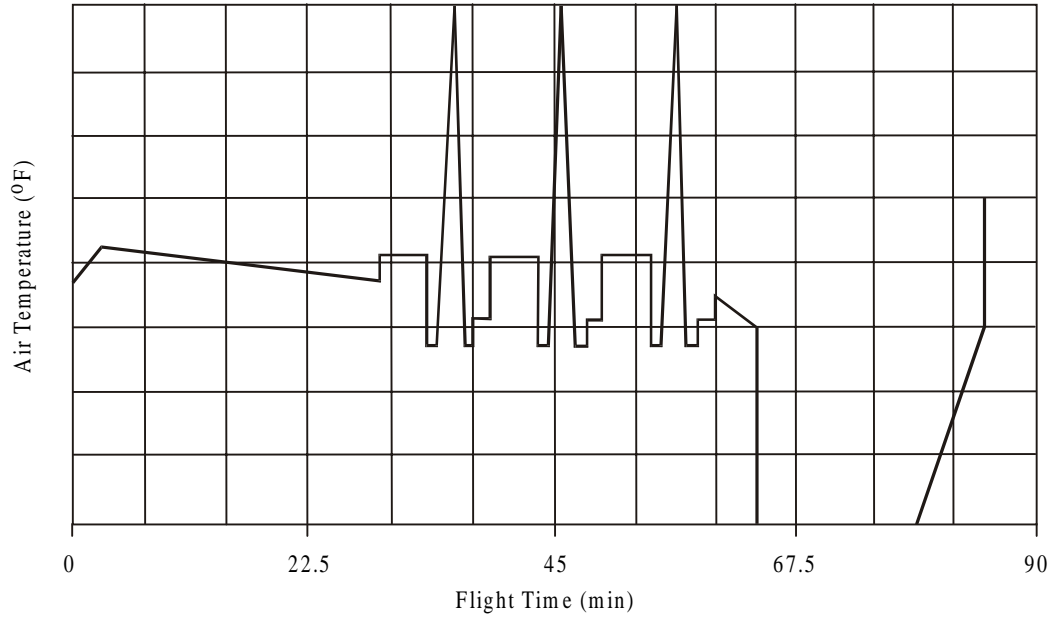

FIGURE 523.2A-2. Temperature profile for a single mission type.

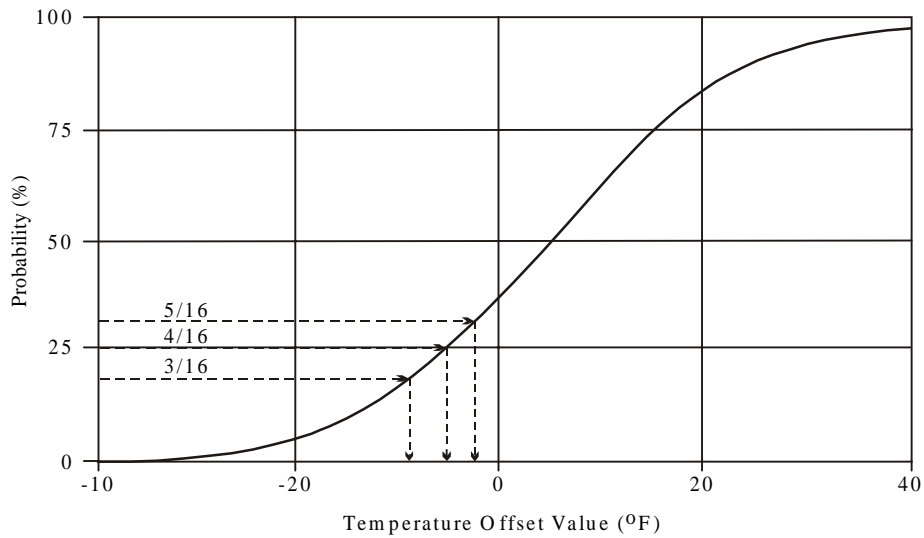

FIGURE 523.2A-3. Selection of equi-probable temperatures from the cumulative distribution of climatic temperatures.

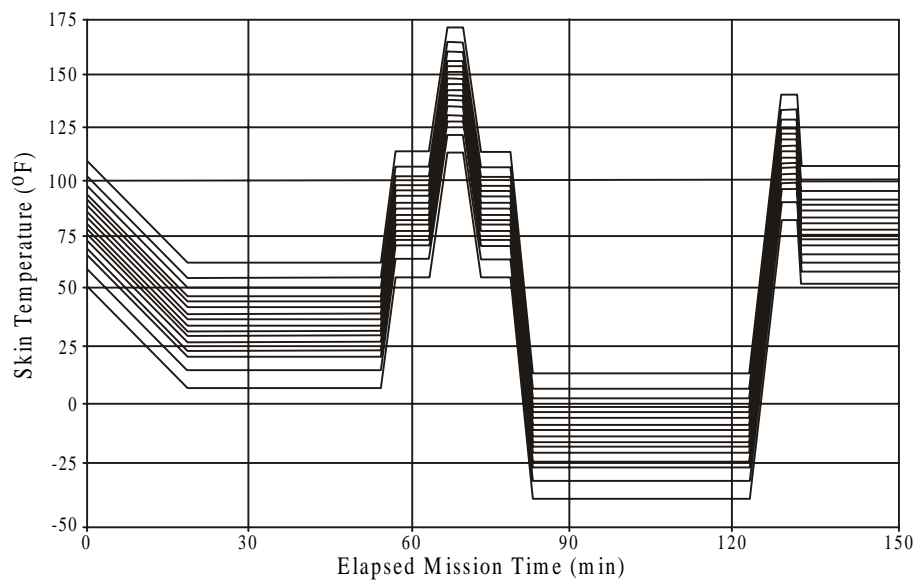

FIGURE 523.2A-4. Climatic set of temperature profiles for composite mission.

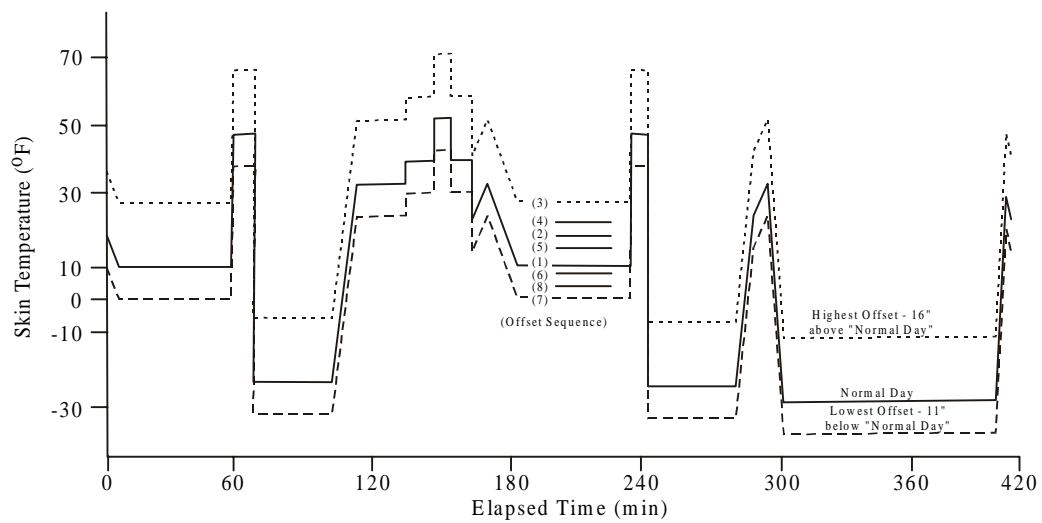

FIGURE 523.2A-5. Climatic set plan showing offset sequences.

MIL-STD-810F
 1 January 2000
 ANNEX A

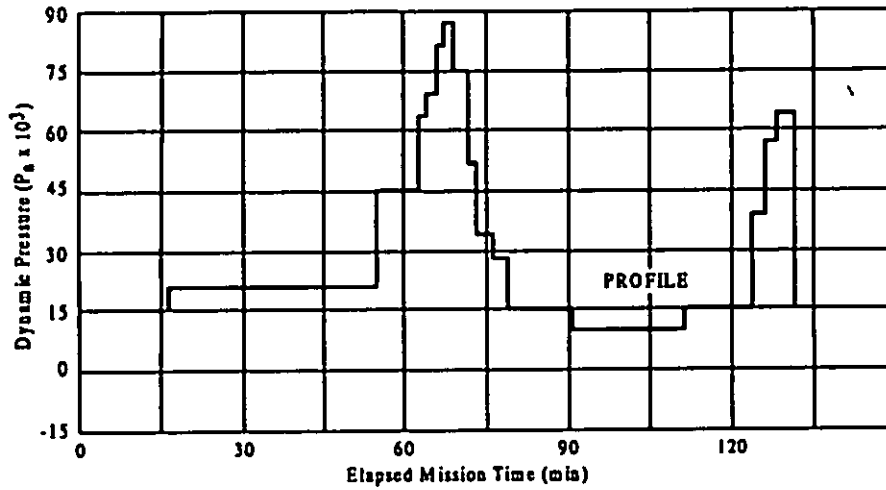

FIGURE 523.2A-6. Dynamic pressure, q, profile for composite mission.

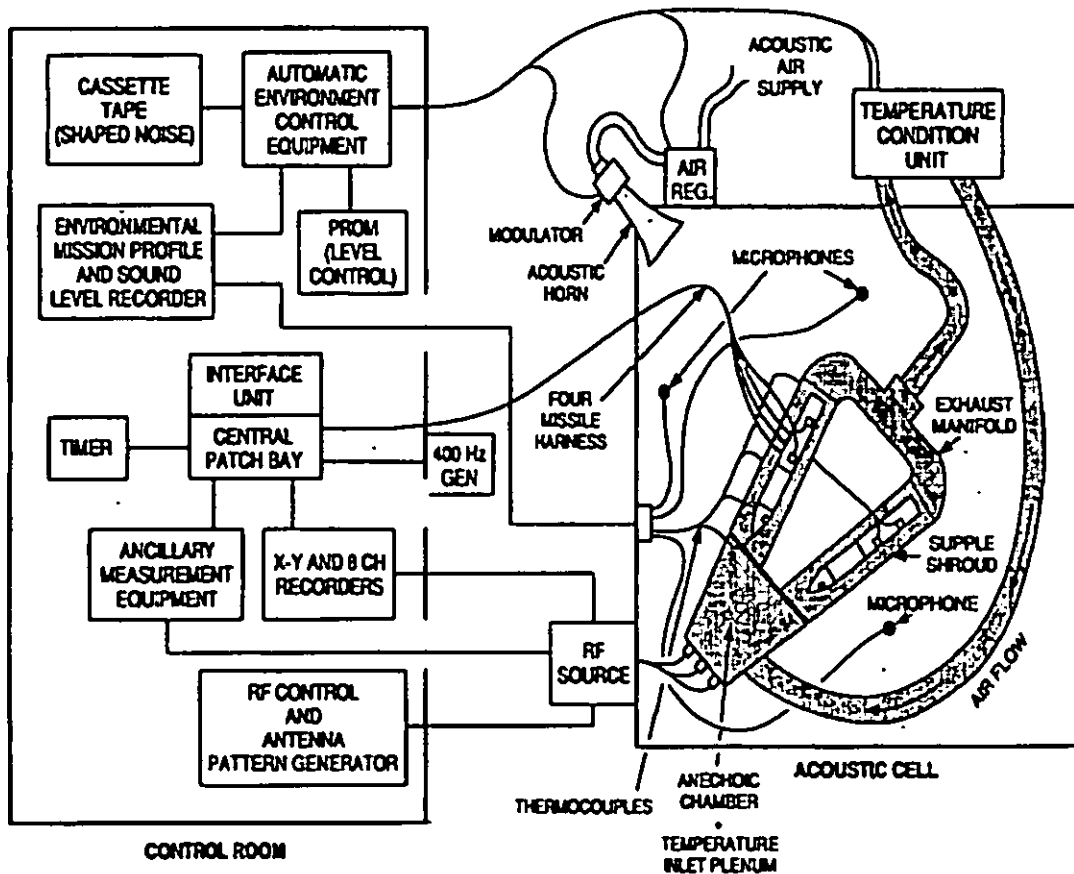

FIGURE 523.2A-7. Typical arrangement of test apparatus.

STANDARDIZATION DOCUMENT IMPROVEMENT PROPOSAL

INSTRUCTIONS

1. The preparing activity must complete blocks 1, 2, 3, and 8. In block 1, both the document number and revision letter should be given.
2. The submitter of this form must complete blocks 4, 5, 6, and 7, and send to preparing activity.
3. The preparing activity must provide a reply within 30 days from receipt of the form.

NOTE: This form may not be used to request copies of documents, nor to request waivers, or clarification of requirements on current contracts. Comments submitted on this form do not constitute or imply authorization to waive any portion of the referenced document(s) or to amend contractual requirements.

I RECOMMEND A CHANGE:

1. DOCUMENT NUMBER
MIL-STD-810

2. DOCUMENT DATE (YYYYMMDD)
20000101

3. DOCUMENT TITLE ENVIRONMENTAL ENGINEERING CONSIDERATIONS AND LABORATORY TESTS

4. NATURE OF CHANGE (Identify paragraph number and include proposed rewrite, if possible. Attach extra sheets as needed.)

5. REASON FOR RECOMMENDATION

6. SUBMITTER

a. NAME (Last, First, Middle Initial)

b. ORGANIZATION

c. ADDRESS (Include Zip Code)

d. TELEPHONE (Include Area Code)
(1) Commercial
(2) AUTOVON
(if applicable)

7. DATE SUBMITTED
(YYYYMMDD)

8. PREPARING ACTIVITY

a. NAME ASC/EN01 (AF-11)

b. TELEPHONE (Include Area Code)
(1) Commercial (513) 255-6281 (2) AUTOVON 785-6281

c. ADDRESS (Include Zip Code)
ASC/EN01, BLDG. 560, 2530 LOOP ROAD W., WRIGHT-PATTERSON
AFB OH 45433-7101

IF YOU DO NOT RECEIVE A REPLY WITHIN 45 DAYS, CONTACT:
Defense Standardization Program Office (DLSC-LM)
8725 John J. Kingman road, Suite 2533, Ft. Belvoir, VA 22060-2533
Telephone (703) 767-6888 AUTOVON 427-6888