

UFC 3-440-06N
16 January 2004

UNIFIED FACILITIES CRITERIA (UFC)

COOLING BUILDINGS BY NATURAL VENTILATION



APPROVED FOR PUBLIC RELEASE; DISTRIBUTION UNLIMITED

UFC 3-440-06N
16 January 2004

UNIFIED FACILITIES CRITERIA (UFC)

COOLING BUILDINGS BY NATURAL VENTILATION

Any copyrighted material included in this UFC is identified at its point of use. Use of the copyrighted material apart from this UFC must have the permission of the copyright holder.

U.S. ARMY CORPS OF ENGINEERS

NAVAL FACILITIES ENGINEERING COMMAND (Preparing Activity)

AIR FORCE CIVIL ENGINEER SUPPORT AGENCY

Record of Changes (changes are indicated by \1\ ... /1/)

Change No.	Date	Location
<u>1</u>	<u>Dec 2005</u>	<u>FOREWORD</u>

This UFC supersedes Military Handbook 1011/2, dated January 1990.

FOREWORD

vii

The Unified Facilities Criteria (UFC) system is prescribed by MIL-STD 3007 and provides planning, design, construction, sustainment, restoration, and modernization criteria, and applies to the Military Departments, the Defense Agencies, and the DoD Field Activities in accordance with [USD\(AT&L\) Memorandum](#) dated 29 May 2002. UFC will be used for all DoD projects and work for other customers where appropriate. All construction outside of the United States is also governed by Status of forces Agreements (SOFA), Host Nation Funded Construction Agreements (HNFA), and in some instances, Bilateral Infrastructure Agreements (BIA.) Therefore, the acquisition team must ensure compliance with the more stringent of the UFC, the SOFA, the HNFA, and the BIA, as applicable.

UFC are living documents and will be periodically reviewed, updated, and made available to users as part of the Services' responsibility for providing technical criteria for military construction. Headquarters, U.S. Army Corps of Engineers (HQUSACE), Naval Facilities Engineering Command (NAVFAC), and Air Force Civil Engineer Support Agency (AFCESA) are responsible for administration of the UFC system. Defense agencies should contact the preparing service for document interpretation and improvements. Technical content of UFC is the responsibility of the cognizant DoD working group. Recommended changes with supporting rationale should be sent to the respective service proponent office by the following electronic form: [Criteria Change Request \(CCR\)](#). The form is also accessible from the Internet sites listed below.

UFC are effective upon issuance and are distributed only in electronic media from the following source:

- Whole Building Design Guide web site <http://dod.wbdg.org/>.

Hard copies of UFC printed from electronic media should be checked against the current electronic version prior to use to ensure that they are current. /1/

AUTHORIZED BY:



DONALD L. BASHAM, P.E.
Chief, Engineering and Construction
U.S. Army Corps of Engineers



DR. JAMES W. WRIGHT, P.E.
Chief Engineer
Naval Facilities Engineering Command

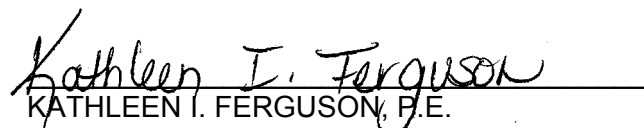

KATHLEEN I. FERGUSON, P.E.
The Deputy Civil Engineer
DCS/Installations & Logistics
Department of the Air Force

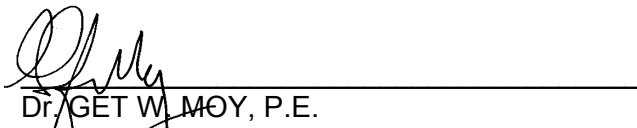

Dr. GET W. MOY, P.E.
Director, Installations Requirements and
Management
Office of the Deputy Under Secretary of Defense
(Installations and Environment)

CONTENTS

	Page
CHAPTER 1 INTRODUCTION	
Paragraph 1-1 PURPOSE AND SCOPE	1-1
1-2 APPLICABILITY	1-1
1-2.1 General Building Requirements	1-1
1-2.2 Safety	1-1
1-2.3 Fire Protection	1-1
1-2.4 Antiterrorism/Force Protection	1-1
1-3 REFERENCES	1-1
APPENDIX A MIL-HDBK 1011/2.....	A-1

CHAPTER 1

INTRODUCTION

1-1 **PURPOSE AND SCOPE.** This UFC is comprised of two sections. Chapter 1 introduces this UFC and provides a listing of references to other Tri-Service documents closely related to the subject. Appendix A contains the full text copy of the previously released Military Handbook (MIL-HDBK) on this subject. This UFC serves as criteria until such time as the full text UFC is developed from the MIL-HDBK and other sources.

This UFC provides general criteria for using natural ventilation to cool buildings.

Note that this document does not constitute a detailed technical design, maintenance or operations manual, and is issued as a general guide to the considerations associated with natural ventilation to cool buildings.

1-2 **APPLICABILITY.** This UFC applies to all Navy service elements and Navy contractors; Army service elements should use the references cited in paragraph 1-3 below; all other DoD agencies may use either document unless explicitly directed otherwise.

1-2.1 **GENERAL BUILDING REQUIREMENTS.** All DoD facilities must comply with UFC 1-200-01, *Design: General Building Requirements*. If any conflict occurs between this UFC and UFC 1-200-01, the requirements of UFC 1-200-01 take precedence.

1-2.2 **SAFETY.** All DoD facilities must comply with DODINST 6055.1 and applicable Occupational Safety and Health Administration (OSHA) safety and health standards.

NOTE: All **NAVY** projects, must comply with OPNAVINST 5100.23 (series), *Navy Occupational Safety and Health Program Manual*. The most recent publication in this series can be accessed at the NAVFAC Safety web site: www.navfac.navy.mil/safety/pub.htm. If any conflict occurs between this UFC and OPNAVINST 5100.23, the requirements of OPNAVINST 5100.23 take precedence.

1-2.3 **FIRE PROTECTION.** All DoD facilities must comply with UFC 3-600-01, *Design: Fire Protection Engineering for Facilities*. If any conflict occurs between this UFC and UFC 3-600-01, the requirements of UFC 3-600-01 take precedence.

1-2.4 **ANTITERRORISM/FORCE PROTECTION.** All DoD facilities must comply with UFC 4-010-01, *Design: DoD Minimum Antiterrorism Standards for Buildings*. If any conflict occurs between this UFC and UFC 4-010-01, the requirements of UFC 4-010-01 take precedence.

1-3 **REFERENCES.** The following Tri-Service publications have valuable information on the subject of this UFC. When the full text UFC is developed for this

UFC 3-440-06N
16 January 2004

subject, applicable portions of these documents will be incorporated into the text. The designer is encouraged to access and review these documents as well as the references cited in Appendix A.

1. US Army Corps of Engineers **USACE TL 1110-3-491**, Sustainable Design
Commander for Military Facilities,
USACE Publication Depot 01 May 2001
ATTN: CEIM-IM-PD
2803 52nd Avenue
Hyattsville, MD 20781-1102
(301) 394-0081 fax: 0084
karl.abt@hq02.usace.army.mil
<http://www.usace.army.mil/inet/usace-docs/>

UFC 3-440-06N
16 January 2004

APPENDIX A

**MIL-HDBK 1011/2
COOLING BUILDINGS BY NATURAL VENTILATION**

+)))))))))
* INCH-POUND *
.)))))))))-
MIL-HDBK-1011/2
31 JANUARY 1990

MILITARY HANDBOOK

COOLING BUILDINGS

BY NATURAL VENTILATION

AMSC N/A

AREA FACR

DISTRIBUTION STATEMENT A. APPROVED FOR PUBLIC RELEASE: DISTRIBUTION IS
UNLIMITED

MIL-HDBK-1011/2

Changes since this manual was published.

Aug 1990

1. Pp 27, Para 4.3.3.2, Line 3 - Deleted hanging parenthesis after "3.2."
2. Pp 37, Para 4.5.3.4, Line 3 - Deleted hanging parenthesis at end of line.
3. Pp 59, Appendix A, Contents, page numbers changed in "FIGURES" section (page numbers did not reflect contents).

MIL-HDBK-1011/2

ABSTRACT

This handbook provides guidance and criteria for the design of buildings to be totally or partially cooled by natural ventilation. It describes several natural criteria; design criteria for natural ventilation and for zoned or seasonal occupant and maintenance manuals, and guidelines for wind tunnel testing. Appendices include forms and overlays for the designer's use and describe the fundamental principles of comfort related to airflow, a methodology for climate analysis, prediction, and evaluation.

MIL-HDBK-1011/2

PAGE iv INTENTIONALLY LEFT BLANK

MIL-HDBK-1011/2

FOREWORD

This handbook has been developed from an evaluation of facilities in the shore establishment, from surveys of the availability of new materials and construction methods, and from selection of the best design practices of the Naval Facilities Engineering Command (NAVFACENGCOM), other Government agencies, and the private sector. This handbook was prepared using, to the maximum extent feasible, national professional society, association, and institute standards. Deviations from this criteria, in the planning, engineering, design, and construction of Naval shore facilities cannot be made without prior approval of NAVFACENGCOM HQ (Code 04).

Design cannot remain static any more than can the functions it serves or the technologies it uses. Accordingly, recommendations for improvement are encouraged and should be furnished to Commander, Pacific Division, Naval Facilities Engineering Command, Code 406, Pearl Harbor, Hawaii 96860-7300, telephone (808) 471-8467.

THIS HANDBOOK SHALL NOT BE USED AS A REFERENCE DOCUMENT FOR PROCUREMENT OF FACILITIES CONSTRUCTION. IT IS TO BE USED IN THE PURCHASE OF FACILITIES ENGINEERING STUDIES AND DESIGN (FINAL PLANS, SPECIFICATIONS, AND COST ESTIMATES). DO NOT REFERENCE IT IN MILITARY OR FEDERAL SPECIFICATIONS OR OTHER PROCUREMENT DOCUMENTS.

MIL-HDBK-1011/2

TROPICAL ENGINEERING CRITERIA MANUALS

<u>Criteria Manual</u>	<u>Title</u>	<u>PA</u>
MIL-HDBK-1011/1	Tropical Engineering	PACDIV
MIL-HDBK-1011/2	Cooling Buildings by Natural Ventilation	PACDIV

MIL-HDBK-1011/2

COOLING BUILDINGS BY NATURAL VENTILATION

CONTENTS

Section 1	INTRODUCTION	
1.1	Scope	1
1.2	Purpose	2
1.3	Objective	2
1.3.1	Naturally Ventilated Buildings and Climate	2
1.3.2	Consideration of Natural Ventilation in the Design Process	2
1.4	Primary Criteria	2
1.5	Responsibilities of Planners and Designers	3
Section 2	COOLING BY NATURAL VENTILATION	
2.1	The Causes of Natural Ventilation	5
2.2	The Cooling Process	5
2.2.1	Bodily Cooling	5
2.2.2	Structural Cooling	6
2.2.3	Combinations of Bodily and Structural Cooling	7
2.2.4	Evaporative Cooling	7
2.2.5	Earth Cooling	8
2.2.6	Combinations of Natural Cooling Strategies	8
2.3	Comfort Criteria	8
2.3.1	The Effect of Air Movement	9
2.3.2	Required Air Velocities for Human Comfort	9
Section 3	DESIGN CRITERIA	
3.1	Building Design for Natural Ventilation	11
3.1.1	Introduction	11
3.1.2	Requirements and Recommendations	11
3.1.2.1	Climate Analysis	11
3.1.2.2	Required Air Changes	11
3.1.2.3	Site Selection	11
3.1.2.4	Site Planning and Landscaping	11
3.1.2.5	Building Envelope and Structure	12
3.1.2.6	Solar Shading	12
3.1.2.7	Thermal Insulation	12
3.1.2.8	Interior Spaces	12
3.1.2.9	Back-up Mechanical Systems	13
3.1.3	Special Considerations	13
3.1.3.1	Mechanical System Integration	13
3.1.3.2	Condensation	13
3.1.3.3	Other Issues	13
3.1.3.4	Building Types Considerations	13
3.1.4	Optimal Configuration to Encourage Ventilation	13
3.1.5	Analysis and Testing Procedure	14
3.1.5.1	Method 1	14
3.1.5.2	Method 2	14
3.1.5.3	Method 3	14
3.1.5.4	Method 4	14
3.1.5.5	Method 5	15
3.2	Building Design for Zoned and Seasonal Combinations	15

MIL-HDBK-1011/2

3.2.1	Introduction	15
3.2.1.1	Zoned Buildings	15
3.2.1.2	Seasonally Adjustable Buildings	15
3.2.2	Requirements and Recommendations	15
3.2.2.1	Early Stages of Design	15
3.2.2.2	Considerations for Zoned Buildings	16
3.2.2.3	Considerations for Seasonably Variable Buildings	16
3.2.2.4	Computer Applications	16
3.2.2.5	Seasonal Adjustments	16
3.2.3	Special Considerations	16
3.2.3.1	Mechanical Systems Integration	16
3.2.3.2	Heat Loss through Glazed Areas	16
3.2.4	Analysis and Testing Procedure	16
Section 4	BUILDING DESIGN FEATURES AND PRACTICES	
4.1	Introduction	17
4.2	Site Selection and Planning	17
4.2.1	General Principles	17
4.2.2	Ventilative Considerations	17
4.2.2.1	Topographic Features	17
4.2.2.2	Obstructions	19
4.2.2.3	Pollution Sources.	19
4.2.2.4	Placing a New Building in a Developed Area.	19
4.2.2.5	Dimensions of the Obstructions.	21
4.2.2.6	Homogeneity or Variability of Building Height.	21
4.2.2.7	Orientation of Streets with Regard to Prevailing Winds	21
4.2.2.8	Distribution, Size and Details of Planted and Open Areas	22
4.2.3	Thermal and Other Considerations	22
4.2.3.1	Solar Shading	22
4.2.3.2	Reflectance	22
4.2.3.3	Slope	23
4.2.3.4	Elevation/Altitude	23
4.2.3.5	Proximity to water	23
4.3	Landscaping	23
4.3.1	General Principles	23
4.3.2	The Shelter Effect	23
4.3.2.1	Effect of the Physical Dimension of Windbreak on Sheltered Areas	23
4.3.2.2	Effect of Porosity of the Windbreak on Sheltered Area	24
4.3.2.3	Wind Incidence	24
4.3.2.4	Type of Vegetation	24
4.3.2.5	Recommendations for Windbreaks	24
4.3.2.6	Recommendations to Avoid Sheltered Areas	27
4.3.3	Change in the Direction and Velocity of Airflow	27
4.3.3.1	Deflecting Airflow	27
4.3.3.2	Increasing Wind Velocities	27
4.3.4	Thermal Considerations	
4.3.4.1	Blocking Solar Radiation	27
4.3.4.2	Ground Reflectance	28
4.3.5	Other Considerations	28
4.3.5.1	Reducing Airborne Dust	28

MIL-HDBK-1011/2

4.3.5.2	Reducing Sound Levels	28
4.3.5.3	Visual Screening	28
4.4	Building Form	28
4.4.1	General Principles	28
4.4.2	Optimal Shape and Orientation	
4.4.2.1	Thermal Considerations	29
4.4.2.2	Ventilation Considerations	29
4.4.2.3	Resolving Conflicts between Thermal and Wind Orientations	30
4.4.3	Elevated Buildings	31
4.5	Building Envelope and Structure	32
4.5.1	General Principles	32
4.5.2	Roof and Roof Ventilators	32
4.5.2.1	Roof Overhang Effects on Room Ventilation	32
4.5.2.2	Roofs--Thermal Considerations	32
4.5.2.3	Ventilators	34
4.5.2.4	Ventilator Placement	34
4.5.2.5	Ventilator Performance	34
4.5.3	Wingwalls	36
4.5.3.1	Ventilative Considerations	36
4.5.3.2	Improving Cross Ventilation	36
4.5.3.3	Placement and Size	37
4.5.3.4	Thermal Considerations	37
4.5.4	Windows	38
4.5.4.1	Ventilation Considerations	38
4.5.4.2	Cross Ventilation	38
4.5.4.3	Windows on One Wall	38
4.5.4.4	Expected Interior Airspeeds	38
4.5.4.5	Effect of Exterior Conditions	40
4.5.4.6	The Vertical Location in the Wall	40
4.5.4.7	Window Type	41
4.5.4.8	Window Shape	41
4.5.4.9	Size	43
4.5.4.10	Insect Screening	44
4.5.4.11	Thermal Considerations	45
4.5.5	Separation of Functions	45
4.5.5.1	Wind Admitting Devices	46
4.5.5.2	Horizontal Shading Devices	47
4.5.5.3	Vertical Shading Devices	49
4.5.5.4	Other Types	49
4.5.5.5	Glazing Type	49
4.5.6	Design Procedure	49
4.5.7	Insulation	49
4.5.7.1	Ventilative Considerations	50
4.5.7.2	Thermal Considerations	50
4.5.7.3	Internal Drapes and Blinds	51
4.5.7.4	Furniture	52
4.6	Auxiliary Fan Systems	52
4.6.1	Ceiling Fans	52
4.6.2	Whole-House Fans	53
4.6.3	Sizing of Openings for Whole-House Fans	53
4.6.4	Fans for Body Cooling	53

MIL-HDBK-1011/2

Section 5	OCCUPANT AND MAINTENANCE MANUALS		
5.1	Purpose		55
5.2	Occupant's Manual		55
5.3	Maintenance Manual		55
APPENDICES			
APPENDIX A	Fundamental Principles		57
APPENDIX B	Climate Analysis Method		77
APPENDIX C	Prediction and Evaluation Methods		101
APPENDIX D	Worked Example of the Climate Analysis and Window Sizing Procedure		133
FIGURES			
Figure 1	MIL-HDBK-1011/2 and the Design Process		1
2	Typical Layout for Body Cooling in a Warm-Humid Climate		6
3	Typical Layout for Structural Cooling in a Hot-Dry Climate		7
4	Typical Layout in a Composite Climate		8
5	Bioclimatic Chart with Base Comfort Zone		9
6	Natural Ventilation Design and Analysis Flowchart		18
7	Effect of Wind Incidence Angle and Shape of Obstructions on Downwind Wake		20
8	Building Wakes and Interbuilding Spacing		21
9	Building Spacing Configuration and Ventilation Availability		22
10	Effect of the Along-wind Depth of Windbreaks on the Sheltered Area		24
11	Shelter Ground Windbreaks		25
12	Effect of Wind Incidence Angle on Sheltered Area		26
13	Acceleration of Wind Under Trees		26
14	Funneling of Air by Landscaping		27
15	Air Accelerated by Landscaping		27
16	Building Orientation and Solar Heat Gain		29
17	Effects of Wind Incidence Angle on Interior Airflow		30
18	Resolving Conflicts Between Thermal and Wind Considerations		31
19	Roof Overhang and Room Ventilation		32
20	Direct Irradiation Values in Btu/Ft. 2-/Hr for 26deg.N Latitude		
33	21	Attic Section with Three Possible Locations for a Radiant Barrier.	34
	22	Effects of Slope on Roof Pressures and Ventilation Characteristics	35
	23	Roof Ventilators--Performance of Simple Flat Plate Ventilators	35
	24	Effect of Wingwalls	36

MIL-HDBK-1011/2

25	Wingwall Acting as Air Flow Diverter	36
26	Wingwall Designs and Their Effects on Interior Air Flow Patterns	37
27	Air Flow Patterns and Pressure Zones	39
28	Ventilation in Rooms with Openings in One Wall	40
29	Air Flow Patterns Through Single Banked Rooms for Various Openings and Partitions	41
30	Effects of Sill Height on Air Flow and Velocity	41
31	Air Flow Patterns Through Single Banked Rooms for Various Window Types	42
32	Window Shape Performance in Relation to Wind Direction	43
33	Effect of Relative Opening Size on Airflow	44
34	Best Location for Insect Screening	45
35	Possible Combination of Wall Systems	46
36	M-Shaped Louvers	47
37	Solar Shading Masks for Overhands and Side Fins	47
38	The Effects of Horizontal Exterior Shading on Interior Airflow	48
39	Effects of Interior Partition Locations on Air Flow Patterns	51
40	Partitions to Split Air Flow	51
41	Air Distribution Patterns for Ceiling Fans	52
42	Air Flow from a Whole-House Fan	53

TABLES

Table	1	Reflectance Values of Various Ground Covers	28
	2	Window Type and Interior Airflow Characteristics	42
	3	Reduction in Wind Velocity Due to Insect Screens As a Function of Incidence Angle	44

GLOSSARY	149
REFERENCES	155
BIBLIOGRAPHY	159

MIL-HDBK-1011/2

PAGE xii INTENTIONALLY LEFT BLANK

MIL-HDBK-1011/2

Section 1: INTRODUCTION

1.1 Scope. This handbook provides guidance and criteria for the design of buildings to be totally or partially cooled by natural ventilation and supports the planning and design process as outlined in Figure 1. This handbook describes a variety of natural cooling techniques and the climatic conditions under which they should be considered. Comfort criteria and manual design method for determining and implementing appropriate cooling strategy(s) and are describes. Building design features and practices are presented for the designer's use. Special considerations related to the integration of mechanical systems and other design issues that will influence comfort and safety are noted. Recommendations for the development of occupant and maintenance manuals are given.

Appendix A includes fundamental principles related to people and comfort, climate, and predicting airflow. Appendix B contains a method of climate analysis; weather data sources, methods for analyzing the weather information and extrapolating it from weather station data to specific sites. Appendix C gives information on window and fan sizing, stack effect and wind tunnel testing, field and computer modeling. Appendix D is a worked example of the climate analysis and window sizing procedure. A selective bibliography and glossary are also included.

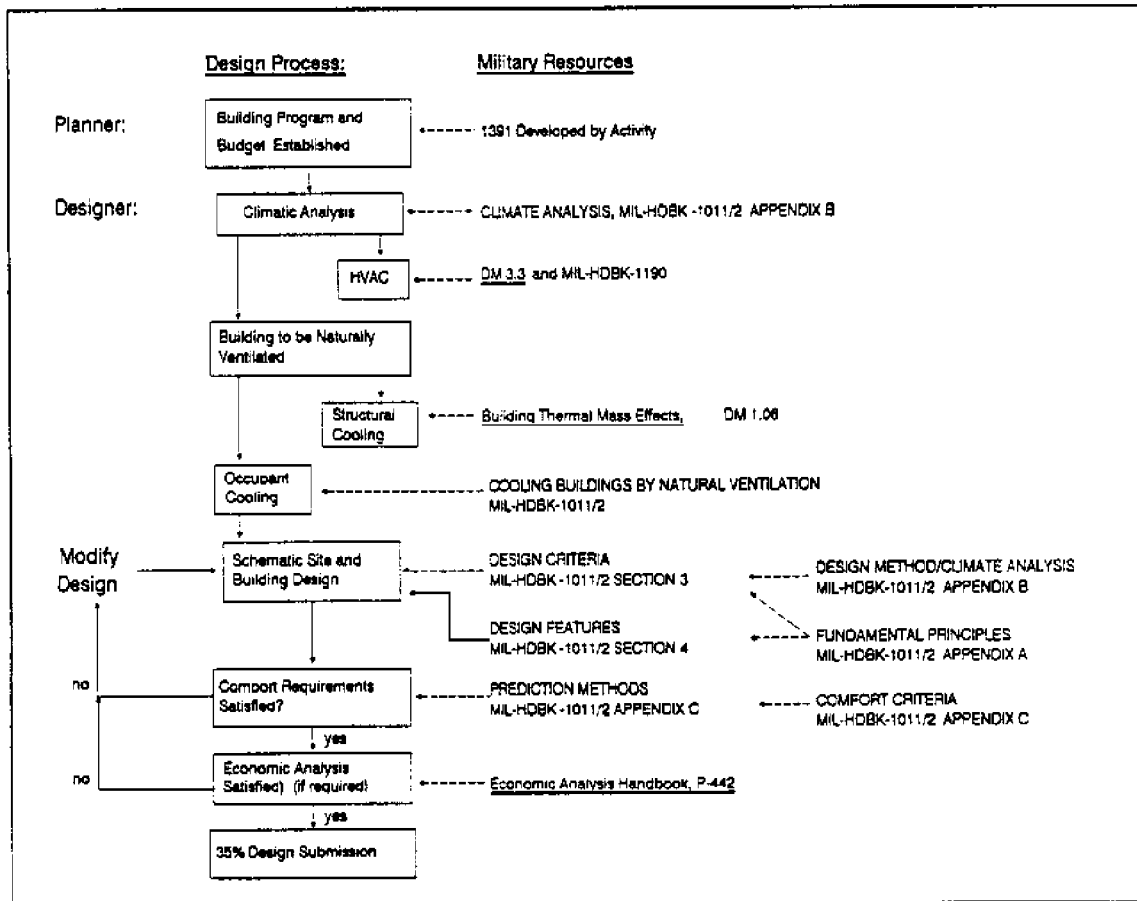

Figure 1
MIL-HDBK-1011/2 and the Design Process

MIL-HDBK-1011/2

1.2 Purpose. When natural ventilation can supplant some or all of a building's mechanical cooling requirements, two types of cost savings may result:

a) The energy costs of operating the air conditioning system.

b) The first cost of unnecessary mechanical equipment. As a result, the Navy is requiring that the potential for natural ventilation be examined in the design of all applicable projects in tradewind and tropical regions.

1.3 Objective. This handbook provides state-of-the-art information on natural ventilation, and a manual procedure for the design of ventilated buildings. Its use will facilitate the design of buildings that save energy by substituting natural ventilation for mechanical cooling. Although "natural ventilation" strictly refers to ventilation induced by external wind or interior thermal buoyancy, the meaning usually includes ventilation from low-powered equipment such as whole-house fans and ceiling fans.

1.3.1 Naturally Ventilated Buildings and Climate. The external climate (temperature, radiation, humidity, and wind) determines the heating and cooling requirements of the building. Since the building envelope acts as a mediator between the external and internal environment, its design and composition affect the interior conditions of the building, its energy consumption and life-cycle cost. The design of naturally ventilated buildings attempts to adjust to the regional and site-specific sun and wind patterns on a daily and annual basis to maximize occupant comfort at minimum energy cost.

1.3.2 Consideration of Natural Ventilation in the Design Process. Because building site has a strong influence on how well natural ventilation will function, it is important that such ventilation be a primary design parameter from the very beginning of the design process. The siting of the building will influence the ease or difficulty with which solar shading may be achieved, how much insulation is required, etc. Ventilation should also be considered throughout the design of the building. This handbook provides guidelines and suggested practices at both of these scales.

1.4 Primary Criteria. This handbook provides a procedure to evaluate the success or failure of a building design by examining the expected percentage of time that human thermal comfort will be achieved. The choice of building cooling strategy (i.e. natural ventilation, evaporative cooling, thermal mass, nocturnal ventilation, or mechanical air conditioning) is determined from the climate data for the site and an evaluation of what strategies work in different climates. Methods are given for determining and achieving the interior ventilation rates required for comfort. When wind or buoyancy-driven ventilation alone cannot provide adequate interior windspeeds for comfort, mechanical fan backup systems shall be used.

Because naturally ventilated buildings respond to the site conditions and microclimate, there is no one set of specific criteria applicable to every naturally ventilated building. However, general building design criteria are included whenever possible. A description of the "optimal configuration" for achieving continuous natural ventilation is presented in para. 3.1.4.

MIL-HDBK-1011/2

1.5 Responsibilities of Planners and Designers. The choice of general site, building program, and cooling strategy is performed by the planner. The designer is responsible for the specific site planning within the given general site and for the design of the building and the site.

This handbook is intended for use both by planners (for assessing the potential for ventilative cooling in a particular climate) and by designers (for establishing the design features of the particular site and building).

To take maximum advantage of the opportunities for natural ventilation of buildings, and thus energy savings, planners and designers shall:

- a) Be sensitive, at all levels of design, to the opportunities for natural ventilation.
- b) Be flexible in their approach to site planning and design.
- c) Perform analysis early in planning, site, and design studies.
- d) Be aware of the significance of specific microclimatic differences and unique constraints of each site.

MIL-HDBK-1011/2

PAGE 4 INTENTIONALLY LEFT BLANK

MIL-HDBK-1011/2

Section 2: COOLING BY NATURAL VENTILATION

2.1 The Causes of Natural Ventilation. Natural ventilation in buildings is produced by pressure differences between the inside and the outside of the building. The magnitude of the pressure difference and the resistance to flow across the openings in the envelope will determine the rate of airflow through the openings. The two main forces producing pressure differences are the wind force and the thermal force or stack effect.

The amount of pressure induced by thermal differences in a building is directly proportional to the vertical height of the enclosed volume of heated or cooled air. Tall room volumes will have strong stack effects, while short room volumes will have little or no stack effects. For low-rise buildings or in medium to high wind conditions, the stack effect may be considered negligible in comparison to wind pressure forces. The stack effect rarely creates enough air movement to cool the occupants directly, but it can provide enough ventilation for fresh air and health requirements. In high-rise buildings, the stack effect may cause strong air movement through elevator shafts and stair towers, but the individual floors are usually separated from other floors so that the stack effect within the floors will be small. This handbook emphasizes the use of wind-induced ventilation.

2.2 The Cooling Process. Although there are many strategies for naturally cooling a building, the primary ones are:

- a) Convective Cooling--cooling of the occupants and/or of the structural mass by air movement,
- b) Radiant Cooling--heat in the building's structure is discharged by longwave radiation to the night sky,
- c) Evaporative Cooling--water is evaporated to cool the interior air or building structure, and
- d) Earth Cooling--soil is used as a heat sink and heat is transferred by direct contact with the soil or through air or water pipes.

Natural ventilation, a form of convective cooling, has the potential to cool the human body directly through convection and evaporation, or indirectly by cooling the structure of the building surrounding the occupants. The choice of cooling strategy is dependent on the climatic factors, the type of building, and the indoor climate desired.

2.2.1 Bodily Cooling. Bodily cooling is effective during overheated periods when the temperature and humidity of the air are above the still air comfort range (refer to para. 2.3 for the definition of the comfort zone). Bodily cooling is especially useful in hot-humid climates where high humidity suppresses the range of daily temperature fluctuation making structural cooling difficult to achieve.

When bodily cooling is desired, buildings should allow maximum airflow across the occupied area and provide protection from the sun and rain. Lightweight structures which respond quickly to lower night temperatures are

MIL-HDBK-1011/2

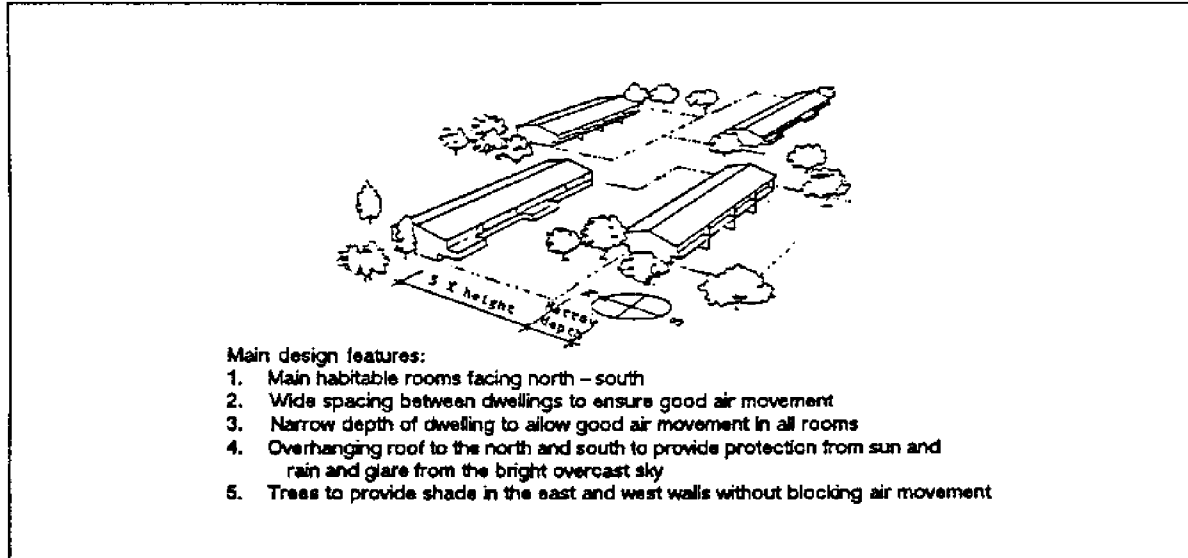

Figure 2
Typical Layout for Body Cooling in a Warm-Humid Climate

desirable. In the extreme case, the best "structure" consists of only an insulated roof-canopy to provide shade and protection from the rain and while allowing maximum ventilation. In practice, careful siting and orientation, narrow elevated buildings, open plans, and use of exterior wingwalls, overhanging eaves, verandahs, and large windows are prevalent elements of naturally ventilated buildings in warm-humid climates (see Figure 2).

2.2.2 Structural Cooling. Structural cooling in which the building mass smooths out the daily temperature variation, is effective in climates which large daily temperature variations (i.e., hot-arid climates). During the day, the building interior is unventilated and the high thermal capacity of the building structure serves as a heat sink for the interior gains. At night, the mass is cooled by longwave radiation to the sky. Cooling may be enhanced by "flushing" the building with cool night air removing the stored structural heat and prechilling the mass for the next day. Night air must be cool enough to receive the stored heat (i.e., the nighttime outdoor air temperatures must be lower than indoor air temperatures, and dip into or below the comfort zone).

Traditional architecture has achieved structural cooling through natural ventilation by means of small closable windows and various forms of wind scoops or wind towers. Ventilation is often enhanced by using pools of water or evaporative screens to cool the incoming air (see Figure 3). Nocturnal ventilation can lower daytime indoor temperatures below that of similarly thermally massive but unventilated buildings by an amount equal to 15 percent of the outdoor temperature range. Therefore if the outdoor temperature range is 59deg.F (15deg.C), an additional 8 to 9deg.F (2 to 3deg.C) indoor daytime temperature reduction can be expected in the nocturnally ventilated, thermally massive building as compared to an unventilated building.

MIL-HDBK-1011/2

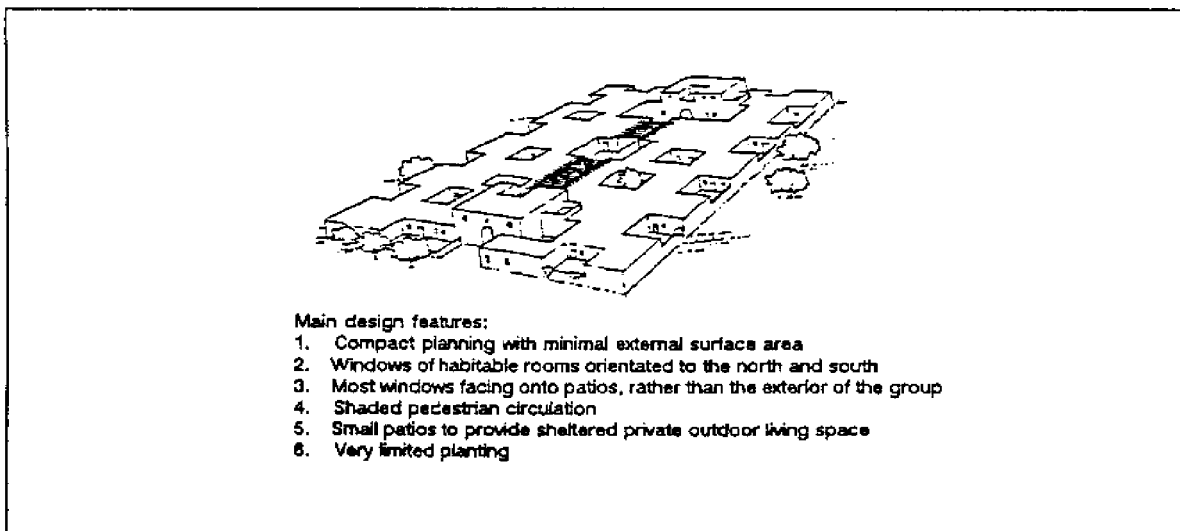

Figure 3
Typical Layout for Structural Cooling in a Hot-Dry Climate

2.2.3 Combinations of Bodily and Structural Cooling. For bodily cooling, ventilation is used both day and night to dissipate the solar heat absorbed by the lightweight building envelope and to cool the building's occupants.

Nocturnal structural cooling does not allow daytime wind-induced bodily cooling. In order to take advantage of the night coolness stored in a structural mass, the building must be unventilated during the day. Thus, structural cooling and daytime bodily cooling by natural ventilation are mutually exclusive. Daytime air movement for body cooling may be achieved by mechanically stirring the air with ceiling fans or some other mechanical equipment. Natural ventilation can be used for bodily cooling during the night when the structure is being ventilated. However, there may be limits to the rate at which cold night air can be introduced to occupied spaces. This depends on the air temperature and the use of the space.

2.2.4 Evaporative Cooling. Evaporative cooling may be used in hot-arid climates where water is available and is most effective in regions with high dry bulb temperatures (greater than 80deg.F or 26.7deg.C) and wet bulb temperatures of 65deg.F (18.3deg.C) or less. Evaporative cooling functions through absorption of sensible heat by water from the air in the phase change of liquid to vapor. Evaporative cooling may be achieved by mechanical or passive (wind induced) means. Two types of evaporative cooling exist: direct, in which the building supply air is humidified, and indirect, in which it is not. A combination indirect and direct evaporative cooling can create cooler temperatures than that of either type alone. A passive direct evaporative cooling system can reduce dry bulb temperature by 40 to 50 percent of the difference between dry bulb and wet bulb temperatures, and a mechanical direct evaporative cooling system by 60 to 80 percent.

MIL-HDBK-1011/2

Evaporative cooling is not covered further in this handbook. For requirements for the design of buildings using evaporative cooling refer to NAVFAC DM 3.03, Heating, Ventilating, Air Conditioning, and Dehumidifying Systems.

2.2.5 Earth Cooling. The earth may be used as a heat sink wherever the below grade soil temperature is lower than the ambient interior temperature. The ground is the only heat sink to which a building can continuously lose heat by means of conduction during the overheated season. There are no simple analytical techniques for predicting the cooling potential of the ground.

2.2.6 Combinations of Natural Cooling Strategies. It is possible to combine the natural cooling strategies, or to use a natural cooling strategy with mechanical air conditioning or heating. Combinations may be achieved on a seasonal basis (such as winter mechanical heating with natural ventilation in the summer for cooling) or by spatial zoning in buildings (partly air conditioned and partly naturally ventilated). Combining the strategies with mechanical systems are especially useful in composite climates where seasonal variations complicate the design of the building (see Figure 4). For a description of zoned buildings refer to para. 3.2.

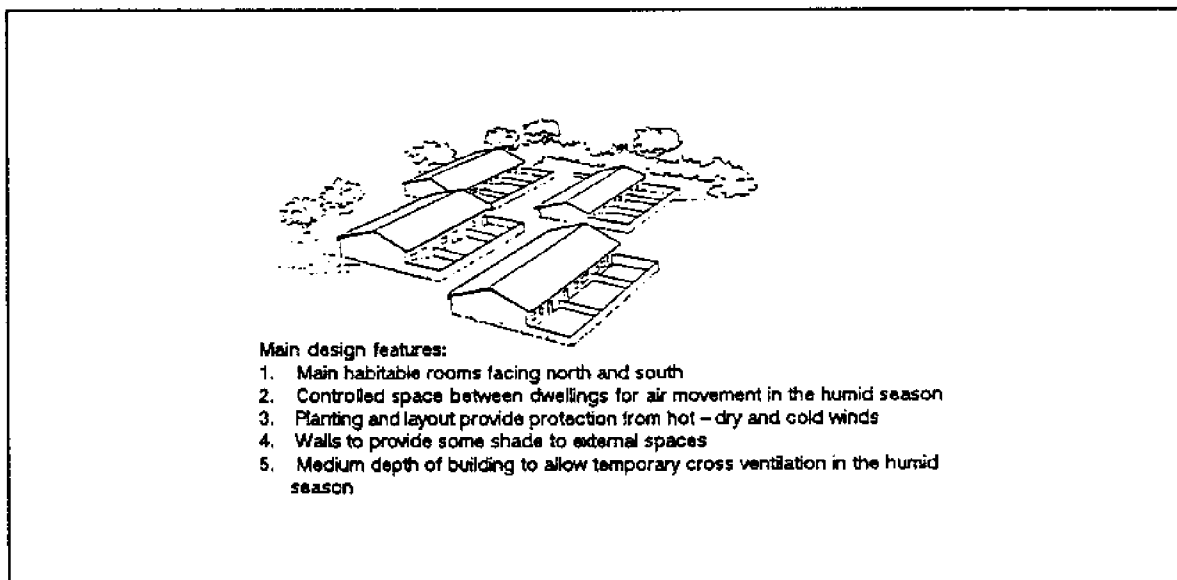

Figure 4
Typical Layout in a Composite Climate

2.3 Comfort Criteria. The acceptable comfort zone shall be that prescribed by the American Society of Heating, Refrigerating, and Air Conditioning Engineers (ASHRAE) Standard 55, Thermal Environmental Conditions for Human Occupancy. Eighty percent or more of the building occupants will find this zone thermally acceptable in still air and shade conditions. Figure 5 shows the acceptable range of temperature and humidity conditions for persons in typical summer (0.35 to 0.6 clo) and winter (0.8 to 1.2 clo) clothing at near sedentary (less than 1.2 met) activity levels. Refer to Appendix A, Section 1 for a more detailed description.

MIL-HDBK-1011/2

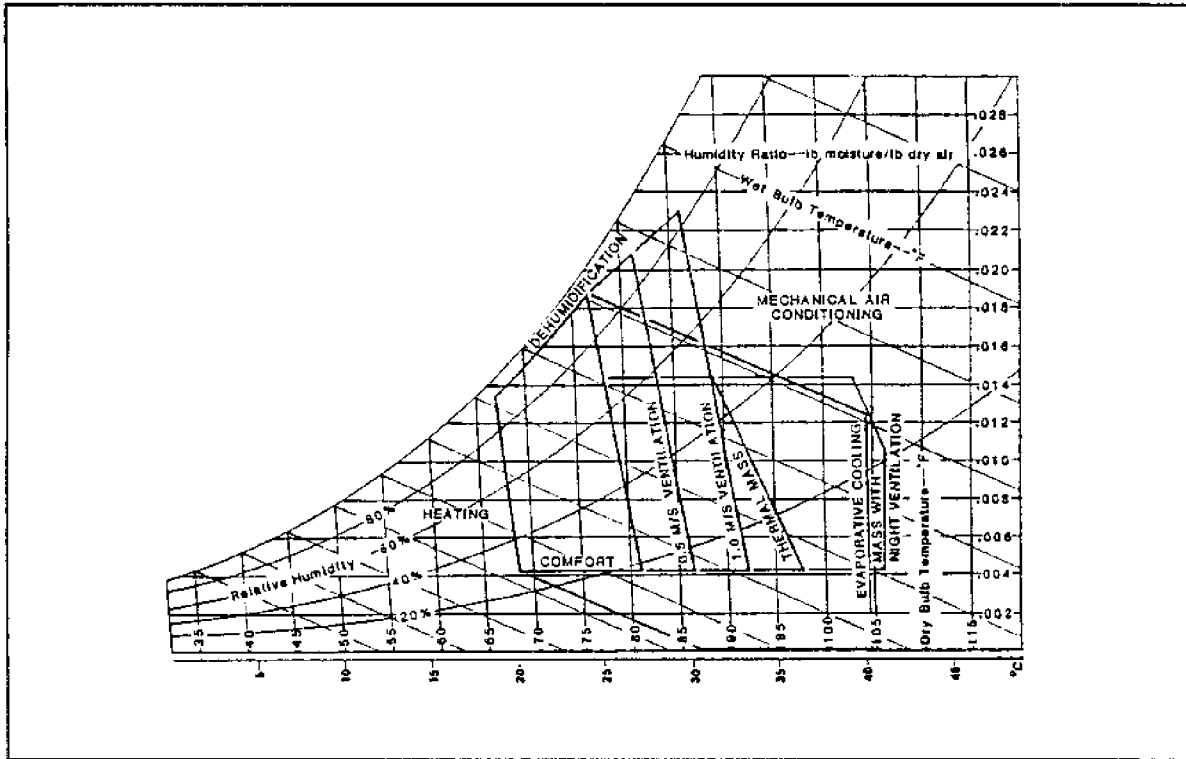

Figure 5
Bioclimatic Chart with Base Comfort Zone

2.3.1 The Effect of Air Movement. Air movement influences the bodily heat balance by affecting the rate of convective heat transfer between the skin and air and the rate of bodily cooling through evaporation of skin moisture. The air velocity lines on Figure 4 show the extent to which increased air movement can increase the range of temperatures and humidities in which people will feel comfortable.

2.3.2 Required Air Velocities for Human Comfort. Minimum rates of ventilation are based on requirements for health (oxygen supply and removal of contaminants.) Ventilation, natural or mechanical, is required at all times. Refer to NAVFAC DM-3.03 for minimum rates by occupancy and building type. The maximum rates of interior air velocity are defined by factors other than human physiological comfort alone.

The upper limit of indoor velocity depends on building type and use. For offices and commercial spaces, the limit is 160 fpm (0.8 m/sec), the point at which loose paper, hair and other light objects may be blown about. In heavy industrial spaces, this limit is not as important as the removal of toxic fumes, heat or other deleterious conditions, and higher indoor velocities (up to 300 fpm or 1.5 m/sec) are acceptable. Maximum indoor air velocities for residential buildings are between these extremes. A practical upper limit is 197 fpm (1.0 m/sec), which is shown on the bioclimatic charts contained in Appendix A.

MIL-HDBK-1011/2

PAGE 10 INTENTIONALLY LEFT BLANK

MIL-HDBK-1011/2

Section 3: DESIGN CRITERIA

3.1 Building Design for Natural Ventilation

3.1.1 Introduction. Continuous ventilative cooling is suitable in hot-humid climates such as Hawaii where the high atmospheric humidity limits the daily swing of temperature. In such climates, buildings cannot cool off sufficiently at night to reduce daytime internal temperatures substantially below the outdoor daytime temperature. The best buildings for such zones have continuous ventilation day and night, both for cooling the occupants directly and for dissipating any internal gains. The indoor temperatures remain close to the outdoor temperatures. These buildings are usually open, relying on their connection to the outside wind environment to achieve the most comfortable interior conditions.

The primary comfort requirements for buildings using natural ventilation are to protect occupants from the sun and rain without obstructing the airflow that cools both the occupants and the building structure. Minimizing heat gain and promoting maximum ventilation are of primary importance.

3.1.2 Requirements and Recommendations

3.1.2.1 Climate Analysis. Perform the Climate Analysis located in Appendix B to determine the number of months that natural ventilation will provide comfort and the air velocity required to achieve comfort in the given climate. This method also examines possible seasonal variations that may affect the building design.

3.1.2.2 Required Air Changes. An outside air exchange rate sufficient to remove internal heat gain must be provided to prevent a rise in interior temperature. Calculate the required air changes to keep the building's interior temperature below the top of the comfort zone at the 98 fpm (0.5 m/sec) internal air movement boundary (refer to Appendix C, Section 2).

3.1.2.3 Site Selection. Sites in which the slope, elevation, orientation, vegetation and wind pattern act to increase summer and winter cooling by wind and decrease radiation effects by shading should be used. Locations near large bodies of water may be preferable if cooling breezes can be directed into the building(s).

To minimize heat gains from solar radiation, south, south-southeasterly and northern slopes are preferable. West and east facing slopes should be avoided due to the difficulty of providing adequate shading. The most desirable wooded sites have high tree canopies and open trunk areas, permitting air movement while providing shade. Avoid sites with dense low canopy trees which block breezes and trap humidity in dead air pockets.

3.1.2.4 Site Planning and Landscaping. Buildings must be spaced to allow winds to reach the ventilation openings. In general, it is not desirable to site buildings within the wake of surrounding structures or landscaping. In most cases dense development should be avoided. The terrain, surrounding vegetation and other nearby structures may be used positively to "channel" or

MIL-HDBK-1011/2

redirect breezes into the building. On sloping sites, locations near the crest of the hill on the windward side are desirable. Valley bottoms should be avoided since they may have reduced air movement.

Street layouts can be used to channel airflow in higher density site planning. If buildings are grouped, airflow principles should be used to determine the most suitable arrangement.

Minimize unshaded paving to reduce the amount of solar heat absorbed and stored near the building. Organic ground covers are preferable to manmade surfaces since they are able to reject solar heat by evaporation. For a description and guidelines refer to paras. 4.2 and 4.3 and Appendix A, Section 3.

3.1.2.5 Building Envelope and Structure. The roof and walls exposed to the sun shall be well-insulated to keep solar gains to a minimum. Light colored, reflective exterior surfaces shall be used. Solid outer walls shall be reduced to a minimum to permit maximum ventilation. The roof becomes the dominant building feature providing protection from the sun and rain. There is an advantage to using lightweight envelopes that will not store daytime heat into the evening hours.

The building envelope shall be designed and constructed to maximize natural ventilation of the interior spaces. The building's orientation and shape are important concerns. One- or two-room-deep plans elongated along the east-west axis are preferable. Window placement, size, type, and position will influence ventilation effectiveness. Elevating the building may also be desirable (refer to Section 4).

3.1.2.6 Solar Shading. Shading of the glazing is required at all times of the year when cooling is required (both natural and mechanical) from 8 am to 6 pm solar time (refer to Appendix B). The shading should be exterior to the glazing to provide maximum protection from radiant solar heat gain. External shading of building surfaces, outdoor living areas and parking lots is also recommended. For a review of shading device types refer to para. 4.5.5.4.

If the proposed design does not meet these shading requirements, the designer should provide heat gain/loss calculations to show that effective solar control will be provided by alternative means and that thermal comfort will be maintained. The solar gain values in para. 4.5 may be used for this purpose.

3.1.2.7 Thermal Insulation. The ceiling should be insulated if an attic is required. Roofs above inhabited spaces, and walls exposed to direct sunlight should also be insulated. For a description of requirements refer to para. 4.5.7.

3.1.2.8 Interior Spaces. Interior occupied spaces shall be shaded and well ventilated. Minimum interior walls, partitions and other obstructions to airflow are desirable. Light, reflective colors are preferable. Heat, moisture, and odor-producing areas should be separated from the rest of the occupied spaces and separately ventilated (refer to para. 4.6).

MIL-HDBK-1011/2

3.1.2.9 Back-up Mechanical Systems. It may be necessary or desirable to include backup ventilation using a whole-house fan, ceiling fans in the interior spaces, or a mechanical ventilation system to ensure comfort when wind-driven ventilation is inadequate. For a description refer to para. 4.6. Ceiling fans are required in all major occupied spaces of naturally ventilated buildings when comfort cannot be achieved by natural ventilation alone based on the Climate Analysis Method in Appendix B.

3.1.3 Special Considerations

3.1.3.1 Mechanical System Integration. Naturally ventilated buildings may not be completely compatible with conventional mechanical systems. Care shall be exercised so that neither cooling strategy undermines the effectiveness of the other. Automatic sensors to detect open windows or doors and to shut down mechanically-conditioned air supply are recommended in naturally ventilated buildings with backup air conditioning or closed-loop ventilating systems.

Natural ventilation of buildings with large openings in the building envelope is inappropriate during months when appreciable heating or air conditioning is required unless the openings can be closed to thermal and infiltrative losses. In such cases, movable insulation shall be considered.

3.1.3.2 Condensation. Condensation may be a problem in buildings combining natural ventilation with mechanical air conditioning. Note that planning and design to minimize mechanical air conditioning loads does not always coincide with planning for natural ventilation. If a combined (zoned) system is desired, each shall be designed for maximum efficiency and the connection between the zones should be carefully detailed.

3.1.3.3 Other Issues. Due to the "open" nature of naturally ventilated buildings, special consideration shall be given to possible problems with noise, privacy, and rain protection.

3.1.3.4 Building Types Considerations. High ventilation rates may not be suitable for offices (where papers may be blown about) or for uses requiring high security, or rigid environmental standards (such as computer and other sensitive instrument rooms, toxic producing processes, hospitals, clinics). In general, natural ventilation shall be considered for all housing projects, recreation facilities, religious buildings, hangars and general purpose storage facilities when climate analysis (refer to Appendix B) indicates that natural ventilation is an acceptable strategy. Storerooms for hazardous materials or for materials requiring humidity control are not addressed by this handbook.

In buildings where natural ventilation is indicated as an acceptable strategy, mechanical cooling may still be necessary for critical areas, but the natural ventilation may be used to reduce energy and mechanical equipment costs in less critical areas. Refer to para. 3.2 for a description of zoned buildings.

3.1.4 Optimal Configuration to Encourage Ventilation. Each building project and site will have a unique set of opportunities and constraints, and shall be considered on a case-by-case basis. The following "ideal" set of design conditions would produce one optimal configuration for ventilation.

MIL-HDBK-1011/2

a) Site Selection and Planning--The optimal site is an open site near the crest of a southfacing hill with a minimum of five building heights between buildings. Avoid solid enclosure walls or fences nearby that might block wind.

b) Building Shape--Buildings shall be elongated along the east-west axis, with the long faces to the south and north, elevated on columns or north-south walls.

c) Landscaping--Nearby ground surfaces should be covered with grass rather than asphalt. Trees and hedges that shade the ground, building surfaces, open outdoor areas, and parking lots should be selected.

d) Building Envelope--Design should provide for adequate insulation and shading to minimize internal heat gains from solar radiation. Large openings in positive and negative pressure zones shall be on the north and south walls for ventilation. If insect screens are necessary, they shall be placed at the balcony walls rather than directly over the windows, to increase the screen area and reduce its resistance to incoming airflow.

e) Interior Planning--For maximum ventilation, the building should be planned with a single loaded corridor and minimal interior partitions in the naturally ventilated rooms. Separate ventilation of odor, heat or humidity producing spaces such as bathrooms should be provided and these spaces should be placed on the lee side of the building. Provide ceiling fans in all major occupied spaces for use when outside wind speeds are too low.

3.1.5 Analysis and Testing Procedure. Every building design shall be evaluated to determine if the required comfort levels are achieved. When evaluating the quality of ventilation from a human comfort standpoint, it is important to consider the interior air distribution as well as the total amount of airflow. One or more of the following five analysis methods (3.1.5.1 through 3.1.5.5) shall be undertaken as early in the design process as possible to facilitate any necessary design changes.

3.1.5.1 Method 1. Perform the window sizing procedure (Appendix C, para. 1.2) for the worst two naturally ventilated months. If the proposed building design meets or exceeds the required window square footage, then acceptable levels of comfort can be expected.

3.1.5.2 Method 2. The ASHRAE formulae may be used to determine interior air movement rates in relatively simple buildings. Refer to Appendix C, para. 1.2 for formulae and description. Examine the two worst naturally ventilated months. If the proposed building design achieves greater or equal air movement than that required from the climate analysis, (Appendix B), then acceptable comfort levels can be expected.

3.1.5.3 Method 3. For complex building shapes or buildings taller than six stories, use a wind tunnel test to obtain direct interior velocity measurements or to obtain surface pressure coefficients for use in the window sizing method. Refer to Appendix C, para. 1.3 for wind tunnel test procedures. For buildings that are complex or house critically important functions, computer analysis using a typical hourly weather tape to estimate indoor thermal conditions is also recommended.

MIL-HDBK-1011/2

Refer to Appendix C, Section 2, for information on computer simulation of building thermal performance.

3.1.5.4 Method 4. For one-story buildings, field modeling may be substituted for wind tunnel testing (refer to Appendix C, para. 1.4 for a description of requirements). The results can be plotted on the bioclimatic chart or input into a computer program to determine comfort levels.

3.1.5.5 Method 5. A thermophysiological model may be used to determine the percentage of time that the building will be comfortable, based on a computer-generated hourly simulation of human thermal comfort. Predictions of the interior air velocity rates (determined by one of the methods listed above), and hourly indoor thermal conditions (from computer thermal analysis) are required as input. For important or complex buildings, this method will provide the most accurate estimate of thermal comfort. Refer to Appendix C, para. 3.1 for a description and procedure.

3.2 Building Design for Zoned and Seasonal Combinations

3.2.1 Introduction. Natural ventilation is commonly combined with Heating-Ventilation and Air Conditioning (HVAC) systems in zoned buildings and seasonally adjustable buildings.

3.2.1.1 Zoned Buildings. The zoning approach combines natural ventilation (or other passive cooling strategies) and HVAC systems spatially within the building. In one form, zoning involves migration of occupants by providing a variety of thermal zones, each of which is comfortable under a different set of climatic conditions. Because each thermal zone is tuned to a limited set of environmental conditions, its design is simpler. The zone approach may exploit a particular site characteristic such as orientation or placement near water, a particular material characteristic such as thermal capacity, a particular climate characteristic such as nighttime downslope winds, or a particular cultural or social pattern such as sleeping outdoors. Traditional examples of such zones are the verandas/porches of the southern U.S. and the rooftop sleeping areas of Middle Eastern buildings.

3.2.1.2 Seasonally Adjustable Buildings. These are suitable for variable climates in which natural ventilation applies for only part of the year. Seasonally adjustable buildings aim at balancing the differing requirements of the various seasons. The characteristics of the building envelope and siting will vary depending upon the length and severity of the seasons. They commonly employ seasonally adjustable features such as storm windows, insulated shutters, and solar shading devices such as awnings and vegetated trellises. Refer to para. 4.5.6.4 for information on solar control.

3.2.2 Requirements and Recommendations. Perform the Climate Analysis in Appendix B to determine the percentage of time that natural ventilation will provide comfort and the air velocity required to achieve comfort in the given climate. This method also examines possible seasonal variations which may affect the building design.

3.2.2.1 Early Stages of Design. The designer should consider zoned or seasonally adjustable envelope configurations during the early stages of design in order to maximize their effectiveness.

MIL-HDBK-1011/2

3.2.2.2 Considerations for Zoned Buildings. To determine the potential for a zoned building, examine the programmed uses of the building. Uses requiring differing environmental conditions suggest a zoned building system.

3.2.2.3 Considerations for Seasonably Variable Buildings. To determine the acceptability of designing a seasonably variable building, determine the number and months when natural ventilation and mechanical systems should be used by completing the Design Method contained in Appendix B.

3.2.2.4 Computer Applications. Review the cooling strategies and design features that could be applicable for different parts of the building and for different times of the year to determine whether combinations of natural ventilation and HVAC systems will work more efficiently than natural ventilation or HVAC alone. For simple buildings, this may not require detailed analysis. In more complex cases, where computer simulation is desirable, the computer program needs to have multizoned or attached-sunspace capabilities in order to simulate a zoned building configuration. Use the concepts in Sections 2 and 3 and the building features in Section 4 for natural ventilation as applicable.

3.2.2.5 Seasonal Adjustments. The naturally ventilated part(s) of the building may require seasonal adjustment in some climates to extend the period of its use. Examples of this seasonal adjustment include screened porches which are enclosed with glass "storm windows" to become useful as sun spaces during the winter. Movable insulation panels may also be used either seasonally or on a night-day cycle to maintain habitability.

3.2.3 Special Considerations

3.2.3.1 Mechanical Systems Integration. In zoned or combination buildings, the connection between the zones must be carefully detailed so that neither side creates a negative thermal impact on the effectiveness of the other side. The naturally ventilated portion of the building should be separated from the mechanically-cooled portion by insulated partitions (a minimum of R-6 insulation for walls, single glazing for windows between zones). Exfiltration from the mechanically cooled zone should not exceed 1 air change per hour during the period when mechanical cooling is in operation.

3.2.3.2 Heat Loss through Glazed Areas. During the heating season, glazed areas are the most vulnerable component of the building envelope to unwanted heat loss by radiation and convection. Movable insulation can substantially reduce both heat loss through glazed components at night and undesirable solar heat admission during the day.

3.2.4 Analysis and Testing Procedure. In complex or important buildings, computer simulation may be necessary or desirable. The computer program must have multizoned or attached sunspace capabilities in order to simulate a zoned building configuration.

A single-zone model cannot provide a useful analysis of building energy use, or of the hourly thermal conditions expected in the various zones. At a minimum, hourly runs should be done for peak four-day periods in each season. The naturally ventilated zone(s) of the building may be evaluated using any of the techniques outlined in para. 3.1.5.

MIL-HDBK-1011/2

Section 4: BUILDING DESIGN FEATURES AND PRACTICES

4.1 Introduction. This section contains information on design features and practices affecting natural ventilation in buildings. Guidelines based on the best available data are provided. Conflicts between differing guidelines will arise in some cases. Resolution of these conflicts is left to the designer's discretion, since each must be handled on a case-by-case basis. Comfort, life-cycle costs, maintenance concerns and functional efficiency should be the primary criteria for such decisions, and designers should draw on their previous experience as well as on the guidelines presented here. In most cases, there are several alternative approaches to achieving a desired effect.

4.2 Site Selection and Planning

4.2.1 General Principles. The siting of a building(s) will have major impacts on the comfort of the building's occupants and on the functioning of the building and its systems. In fact, the feasibility of using natural ventilation for cooling may depend on proper siting. Consideration of the wind and thermal implications of site planning and selection must be given the highest priority for any building project in the earliest stages of the planning and design process.

The first task of the planner or designer is to identify the most suitable site for the building(s) to take advantage of the favorable, and to mitigate the adverse, characteristics of the site and its microclimate. For buildings using natural ventilation, this includes avoiding enclosed valleys and sheltered locations, maintaining adequate building spacing (avoiding wind shadows and wakes) and organizing the site layout to increase interior air velocities and minimize interior heat gain.

Design of the buildings should not only be related to conditions in the building interior, but also to the external spaces between and around them. Comfortable outdoor spaces can provide valuable additional or alternative living area in many types of projects.

4.2.2 Ventilative Considerations. The major site factors affecting ventilation are described in paras. 4.2.2.1 through 4.2.2.8. Figure 6 is a flowchart for design and analysis of factors.

4.2.2.1 Topographic Features. If maximum ventilation is desired, avoid enclosed valleys and very sheltered locations. Sites near the crest of hills or ridges may provide increased exposure to winds for ventilation. Ridge crests can receive wind speeds higher than those on flat ground; an increase of 20 percent is an average rule of thumb. In very windy locations, sites at the crest of hills or mountains may receive too much wind with potential for problems with structure and driving rain. Appendix A, Section 2 discusses airflow around such features as hills and valleys.

If continuous ventilation is desired, sites on or near the top of a slope (for increased wind exposure), and facing south (to southeast for decreased afternoon solar exposure) are recommended. If night ventilation is desired, recommended sites are those near the bottom of a slope (to catch the

MIL-HDBK-1011/2

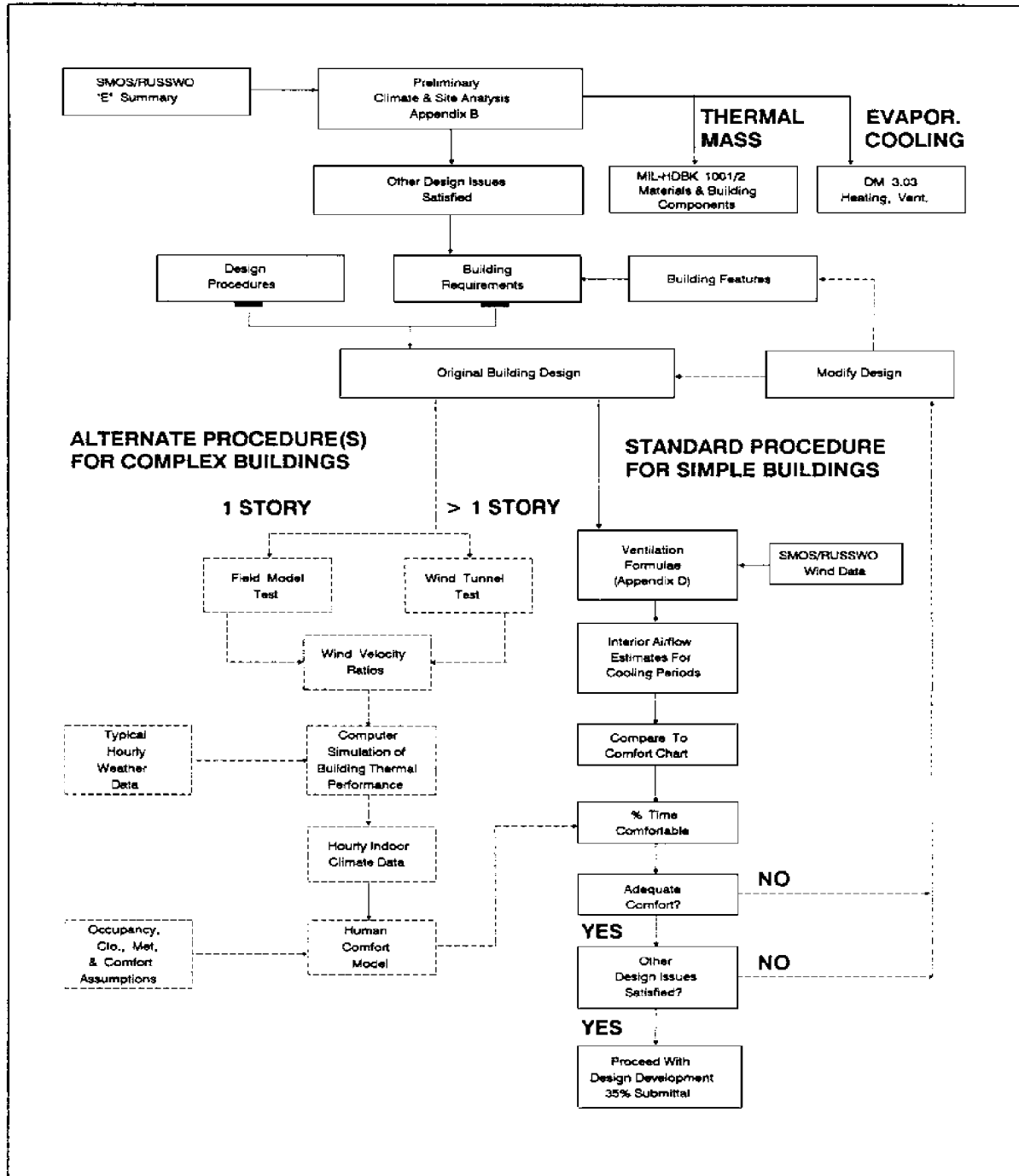

Figure 6
Natural Ventilation Design and Analysis Flowchart

MIL-HDBK-1011/2

nighttime downslope winds), and facing south to southeast for decreased exposure to afternoon sun. In cooler temperate climates, sites in the middle to upper part of the slope facing south are recommended for access to sun and wind.

4.2.2.2 Obstructions. Obstructions include elements such as buildings, fences, trees and other landscaping. They affect both the wind and sun impinging on the building. Important wind effects of obstructions include airflow at: flows on the windward face, corner flows, and wakes. Para. 4.3 and Section 3 of Appendix A discuss airflow around simple buildings and windbreaks. Figures 7 and 8 show wake effects of complex buildings shapes.

To maximize ventilation, buildings should not be sited within the wake of any obstruction and should be placed sufficiently far apart that each acts in isolation. To achieve this, a clear spacing of at least 5H (five times the height of the upwind building) is required. If the spacing is closer, the downwind building is placed within the wake of the upwind building resulting in lowered local air velocities and the possible establishment of a vortex or roller of trapped air. Such rollers are stable at clear spacings of less than 1.5H (one and one-half times the height of the upwind building) and ventilation through the downwind building can be quite weak. For spacings between 1.5 and 5H, the airflow oscillates between the two patterns shown in Figure 8 and ventilation in the downwind building(s) will be sporadic and much less effective than if properly spaced.

4.2.2.3 Pollution Sources. Because it is too difficult to filter pollutants from the air entering naturally ventilated buildings, the building(s) should be upwind of pollution sources. When this is not possible, it is desirable to position them as far as possible from upwind pollution sources, such as kitchen exhausts or major roads, so that the pollution has space to disperse in the atmosphere before reaching the building.

4.2.2.4 Placing a New Building in a Developed Area. In positioning more than one building, or a new building in an already developed area, provision for air movement must be one of the most important considerations. New buildings are not only affected by the existing buildings around them but they can also affect the ventilation in the existing buildings and the air movement in surrounding open spaces. Buildings and open spaces can be organized to preserve each building's access to prevailing breezes. For the same density, high buildings surrounded by large open spaces have better ventilation than more closely spaced low-rise buildings.

The important influences on urban winds are:

- a) dimensions of obstructions,
- b) spacing between obstructions,
- c) homogeneity or variability of building height,
- d) orientation of streets with regard to prevailing winds, and
- e) distribution, size, density, and details of planted and open areas.

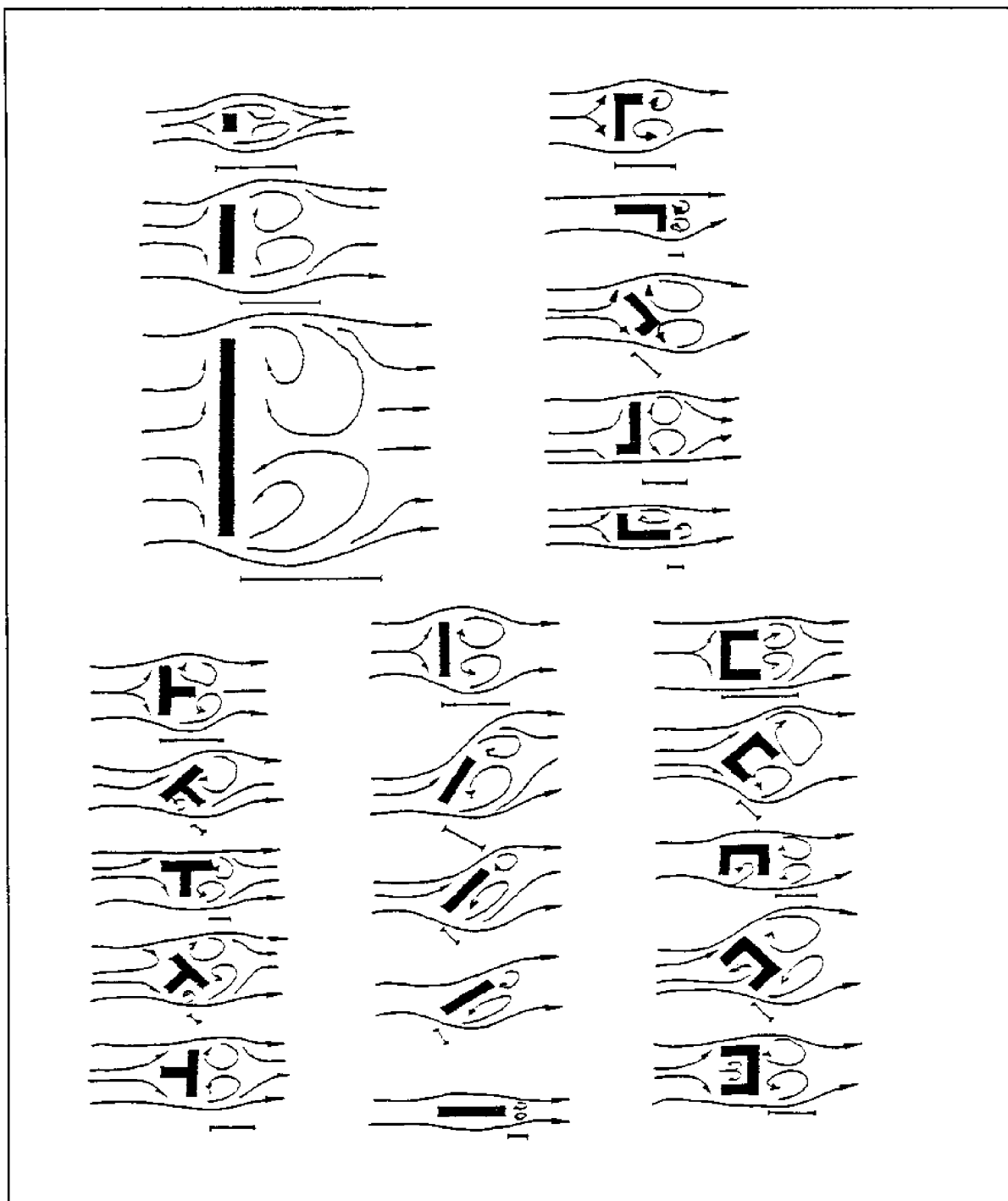

Figure 7
Effect of Wind Incidence Angle, and
the Length and Shape of Obstructions on Downwind Wake

MIL-HDBK-1011/2

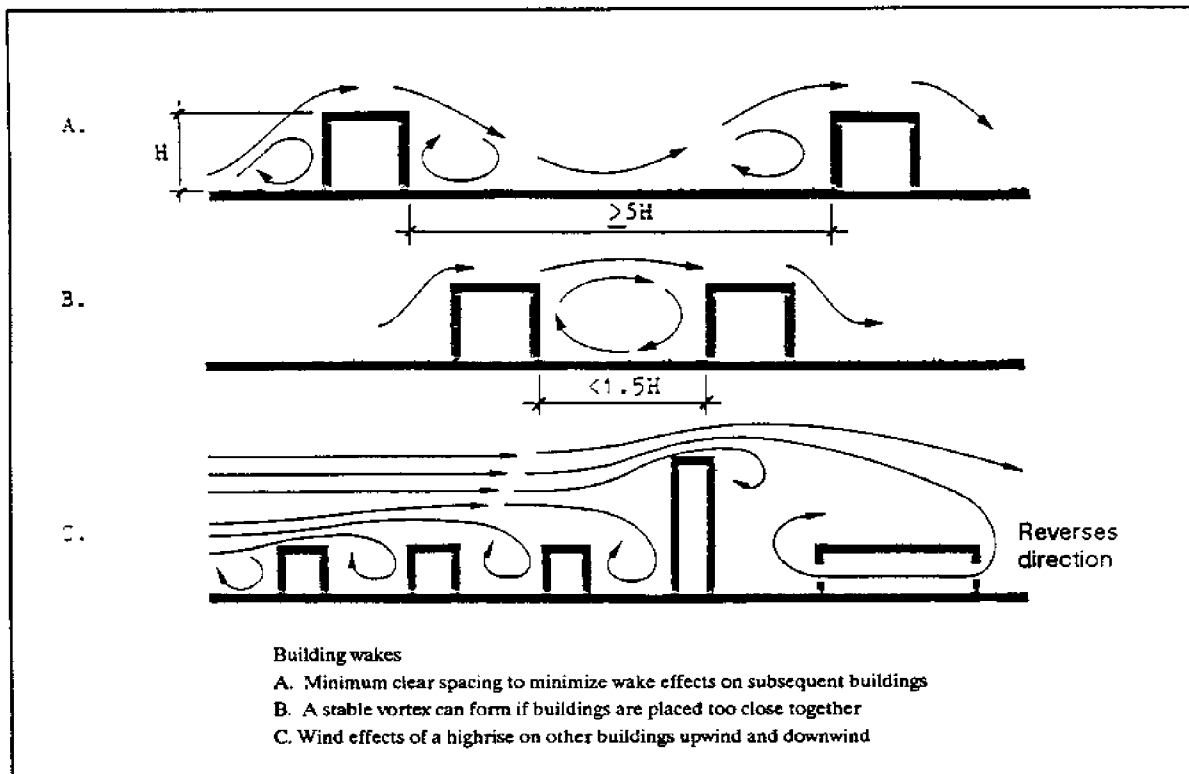

Figure 8
Building Wakes and Interbuilding Spacing

4.2.2.5 Dimensions of the Obstructions. The dimensions of the obstructions affect the size and extent of the wake zones. In general, the larger and taller the obstruction, the longer the wake. The spacing between the obstructions determines whether the leeward obstruction will be within the recirculating wake of the upwind obstruction. As described in para. 4.2.2.2, a minimum clear spacing of five heights of the upwind obstruction is required.

4.2.2.6 Homogeneity or Variability of Building Height. Placing a highrise building in an area of low-rise development may create strong air currents at ground level (refer to Appendix A). If the upwind building is higher than the downwind one, the lee roller of the highrise may sufficiently engulf the downwind building to cause ventilation in the downwind building to reverse direction (see Figure 8c).

If the building is taller than six stories, a wind tunnel test is required to determine the pedestrian-level winds (refer to Wind Tunnel Testing, para. 1.3 in Appendix C).

4.2.2.7 Orientation of Streets with Regard to Prevailing Winds. If streets are laid out parallel to the prevailing winds, the wind will be funneled into the streets. This funneling will be more pronounced if no major gaps occur between the buildings lining the streets. If streets are laid perpendicular

MIL-HDBK-1011/2

to the prevailing winds and buildings are continuous, the flow will depend on street width as described in para. 4.2.2.2. As in the case of single buildings, a clear spacing (street width) of at least five heights of the upwind building is required for the downwind building to have unobstructed ventilation.

Grid patterns of buildings require larger building-to-building spacing to maintain ventilation due to the shapes of the building wakes. If the buildings are staggered in a checkerboard pattern perpendicular to the wind (Figure 9), ventilation can be maintained with closer spacing and wake effects are somewhat reduced.

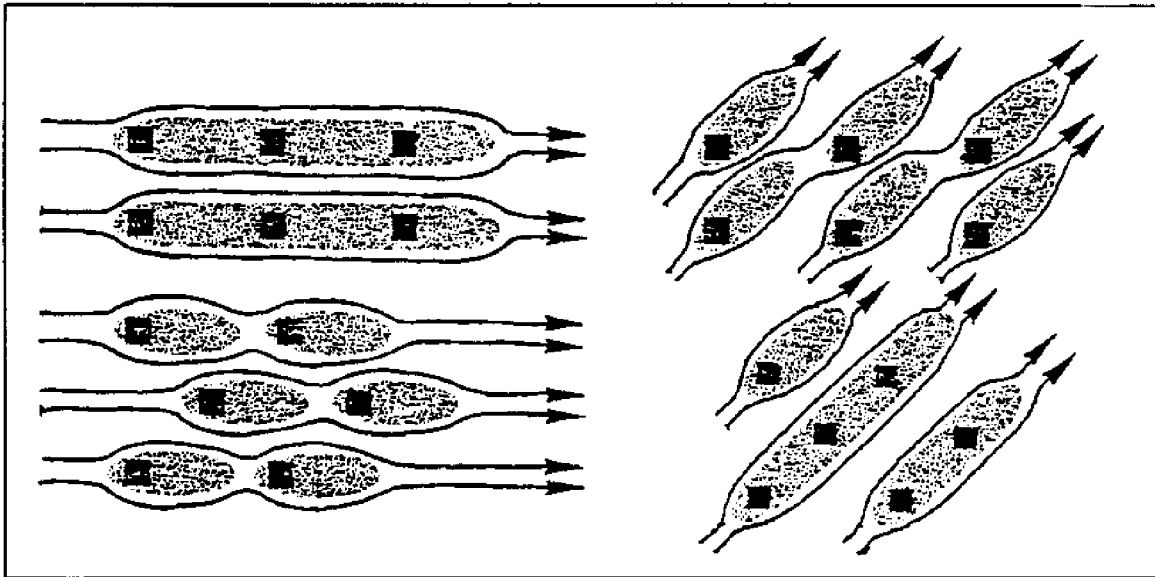

9

Building Spacing Configuration and Ventilation Availability

Figure

4.2.2.8 Distribution, Size and Details of Planted and Open Areas. Planted areas can have a pronounced effect on airflow patterns and speeds. In general, grassy open areas without dense trees or bushes allow the air close to the ground to be cooled and to return to its unobstructed velocity. Sunlit open areas with manmade surfaces may heat the air above them and should be minimized on the windward sides of naturally ventilated buildings. Trees can provide shade but may also block wind if their understory is too dense. For details, refer to para. 4.3.

4.2.3 Thermal and Other Considerations. Other major factors to be considered in assessing the local features as they affect site planning are presented in paras. 4.2.3.1 through 4.2.3.5.

4.2.3.1 Solar Shading. Topographic features and obstructions may provide shade and reduce solar gains. Buildings can be arranged to provide shade for adjacent structures and exterior spaces. The extent and timing of shading due to nearby obstructions can be determined using a sun path diagram. Refer to the latest edition of Architectural Graphic Standards for instructions.

MIL-HDBK-1011/2

Close building spacing may decrease natural daylight and adversely affect ventilation. Daylighting is not usually a problem for residential types of buildings in hot climates. Whether the ventilation is affected depends largely on the direction of the prevailing wind.

4.2.3.2 Reflectance. The reflectance of nearby surfaces, especially obstructions and ground surfaces near openings, can have a large effect on the interior temperatures of the building. Reflected light and local heat sources, such as nearby asphalt pavement, can substantially increase internal temperatures of naturally ventilated buildings and should be avoided, especially on the windward side. Refer also to para 4.3.

4.2.3.3 Slope. A sloping site may affect the heat gain of the buildings if it restricts the orientation of the building and its windows. The optimal orientation for the long face of a building and for windows is north-south facing. Sloping sites which require placement of windows to the east or west should be avoided because they are more difficult to shade.

4.2.3.4 Elevation/Altitude. With increasing altitude, temperature and pollution decreases; precipitation (rainfall, snow, and fog), insolation, and daily temperature range increase.

4.2.3.5 Proximity to water. Proximity to large bodies of water may serve to moderate temperature extremes because water stores more and radiates less solar energy than soil. On a smaller scale, ponds or sprays may be used to provide cooling when located near interior spaces if the climate is not too humid.

4.3 Landscaping

4.3.1 General Principles. Landscaping may affect the microclimate of the building site and the air movement in and around buildings. (Refer to Appendix A, Section 2). For naturally ventilated building sites, landscaping may be effectively used to provide shade for both the building and for the surrounding outdoor spaces. Landscaping may also be used to increase ventilative potential or provide shelter from excessive wind.

4.3.2 The Shelter Effect. Windbreaks can protect both buildings and open spaces from hot or cold winds. A windbreak of vegetation creates areas of lower wind velocity in its lee by:

- a) deflecting some of the wind over the windbreak and the zone immediately to the leeward of the barrier,
- b) absorbing some of the air's momentum, and
- c) dissipating some of the air's directed momentum into random turbulent eddies.

Vegetation is more effective at absorbing wind energy than solid objects, such as buildings, which primarily deflect the wind.

4.3.2.1 Effect of the Physical Dimension of Windbreak on Sheltered Areas. The leeward sheltered area varies with the length, height, depth and density

MIL-HDBK-1011/2

of the windbreak. As the height and length of the windbreak increase, so does the depth of the sheltered area. The sheltered area also increases with windbreak depth, up to a depth of two windbreak heights ($2H$). If the windbreak depth is increased beyond $2H$ then the flow "reattaches" to the top of the windbreak and the length of the sheltered area decreases (see Figure 10). An area of slightly lowered velocity also exists for $10H$ in front of the shelterbelt or windbreak (see Figure 11).

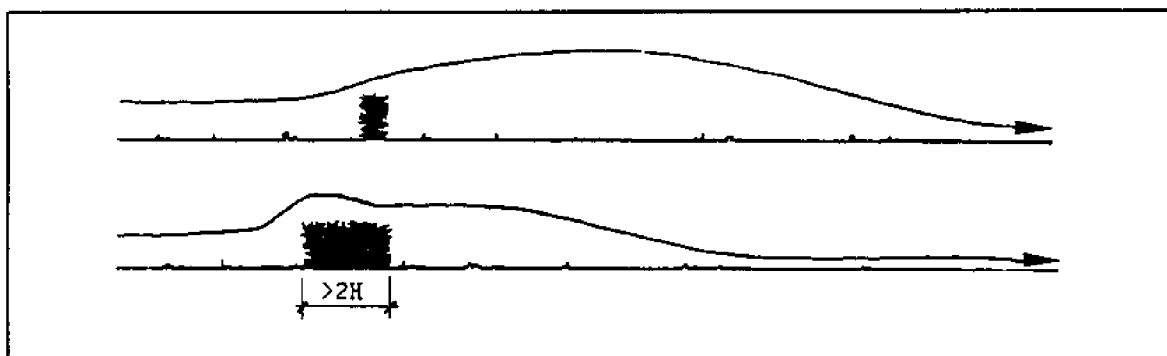

Figure 10
Effect of the Along-wind Depth of Windbreaks on the Sheltered Area

4.3.2.2 **Effect of Porosity of the Windbreak on Sheltered Area.** The extent of the sheltered area produced also varies with the porosity of the barrier. Porous barriers cause less turbulence and can create a greater area of total shelter (reduced speeds) than solid barriers. The more solid the barrier, the shorter the distance to the point of minimum wind velocity and the greater the reduction in velocity at that point. The velocity, however increases more rapidly downwind of the minimum point providing less sheltered area than behind a more porous barrier (see Figure 11).

4.3.2.3 **Wind Incidence.** The incidence angle of the wind also affects the length of the sheltered area. Tree and hedge windbreaks are most effective when the wind is normal to the windbreak. If the wind approaches a windbreak at an oblique angle, the sheltered area is reduced (see Figure 12).

4.3.2.4 **Type of Vegetation.** Hedges provide a more pronounced sheltering effect than trees because they have foliage extending to the ground level. In fact, the flow beneath the branches (around the trunks) of trees can actually be accelerated above the free wind speed upwind of the tree (see Figure 13).

4.3.2.5 **Recommendations for Windbreaks.** If a sheltered area is desired for a zoned or seasonally adjustable building, it is recommended that the landscaping be designed to allow for reduced velocities without large scale turbulence. To achieve this, windbreaks should be at least 35 percent porous. The windbreak is most effective when the building it is to protect is located within $1\frac{1}{2}$ to 5 heights of the windbreak.

MIL-HDBK-1011/2

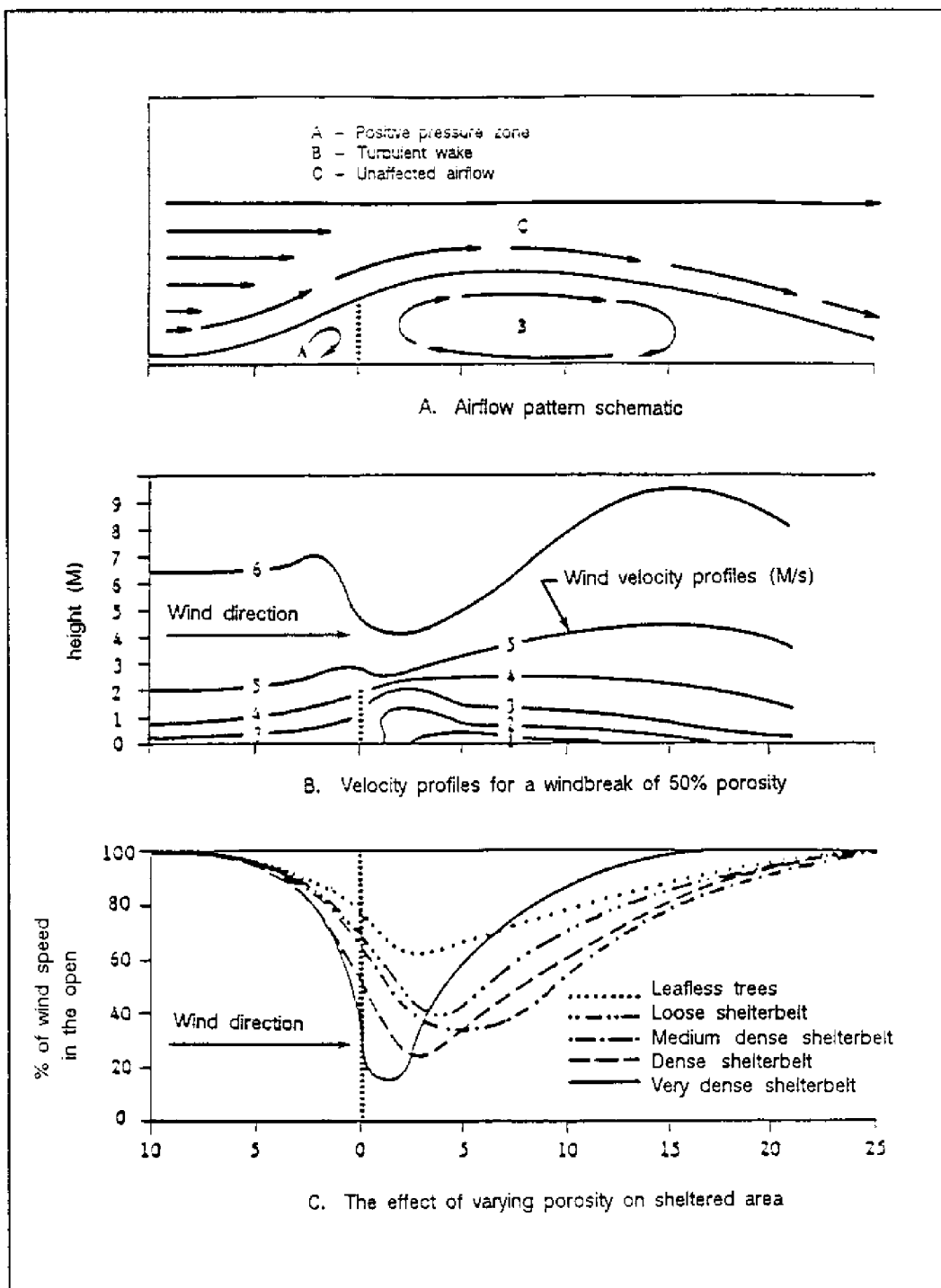

Figure 11
 Shelter Ground Windbreaks

MIL-HDBK-1011/2

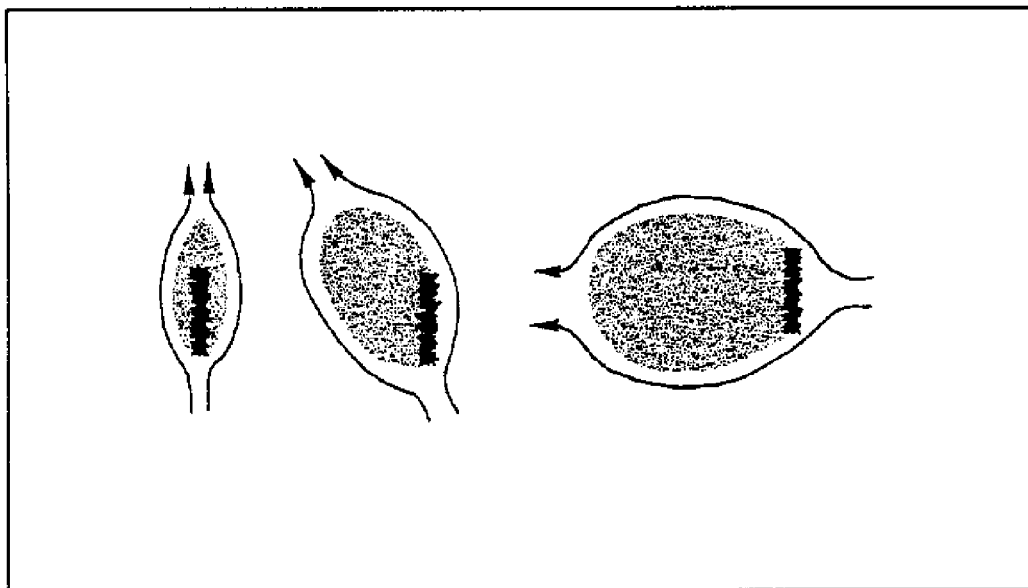

Figure 12
Effect of Wind Incidence Angle on Sheltered Area

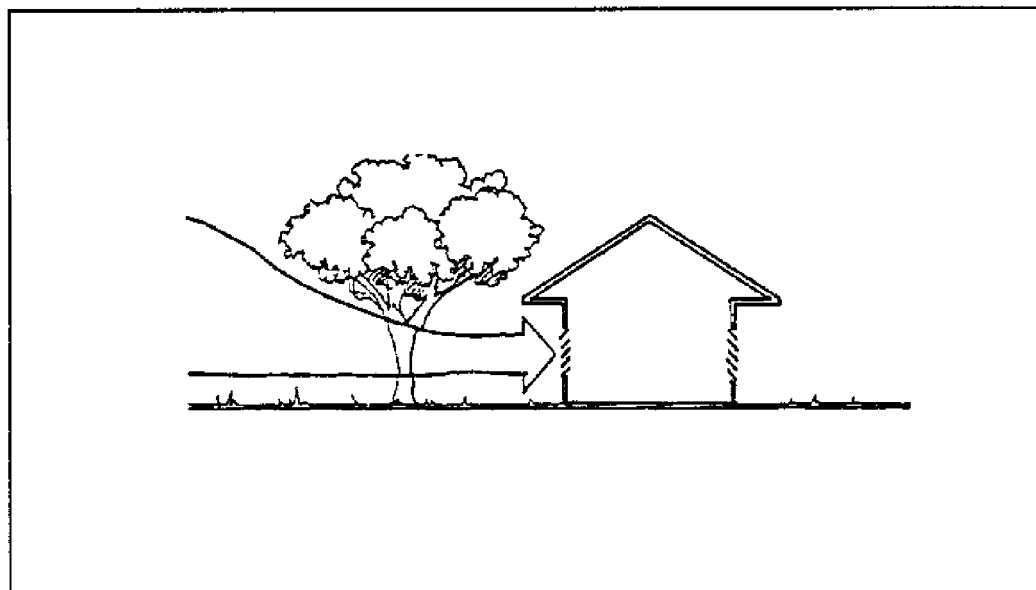

Figure 13
Acceleration of Wind Under Trees

MIL-HDBK-1011/2

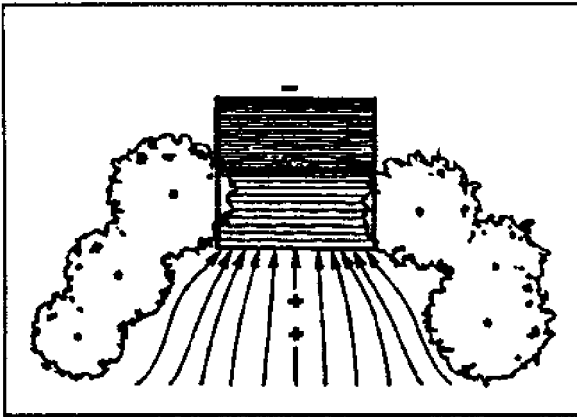

Figure 14
Funneling of Air by Landscaping

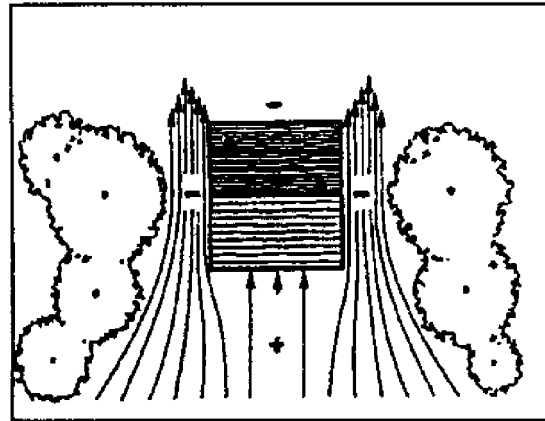

Figure 15
Air Accelerated by Landscaping

4.3.2.6 Recommendations to Avoid Sheltered Areas. If shelter is not desired, plant trees far apart. Shade trees can be used around buildings without too much ventilation interference if the trees are tall, the trunks are kept bare and the trees are kept close to the building (see Figure 13). Dense hedges should not be placed so that they affect the airflow through building openings.

4.3.3 Change in the Direction and Velocity of Airflow

4.3.3.1 Deflecting Airflow. Rows of trees and hedges can direct air towards or away from a building (see Figure 13). For ventilation, it is generally best to orient rows perpendicular to the window walls to channel airflow towards openings, provided that solar control is maintained.

Dense hedges can be used in a manner similar to solid building wingwalls to deflect air into the building openings. Refer to para. 4.5.3. Vegetation may be used to create positive and negative pressure zones for ventilation or to increase the windward area of the building. Per unit area, vegetation will not be as efficient as solid wingwalls in producing these effects, but it can be more cost effective than wingwalls because it can be much larger at a lower cost.

4.3.3.2 Increasing Wind Velocities. Vegetation can create areas of higher wind velocities by deflecting winds or by funneling air through a narrow opening. See Figure 15 and Appendix C, para. 3.2. Narrowing the spacing of the trees used to funnel air can increase the airflow 25 percent above that of the upwind velocity. A similar effect occurs at the side edge of a windbreak.

4.3.4 Thermal Considerations

4.3.4.1 Blocking Solar Radiation. Large-scale landscaping such as trees and vines on trellises are used to shade buildings and the surrounding ground surfaces. This reduces direct solar gain to the building and indirect radiation reflected upward into the building from the ground. Trees can block up to 70 percent of the direct solar radiation, and also filter and cool surrounding air through transpiration.

MIL-HDBK-1011/2

4.3.4.2 Ground Reflectance.

Natural ground covers tend to be less reflective than bare soil or manmade surfaces, (Table 1) thereby reducing ground-reflected radiation. Ground-reflected light represents 10 to 15 percent of the total solar radiation transmitted to the first floor of a building on the sunlit side and may account for greater than 50 percent of total radiation transmitted on the shaded side.

Some portions of this radiation can provide desirable daylighting within the building, but glare and total solar gain are usually greater problems in hot climates.

In general, trees and shrubs and other irregular, vegetation have lower reflectivity than planar vegetated surfaces such as grass.

4.3.5 Other Considerations

4.3.5.1 Reducing Airborne Dust. Vegetation filters the air and minimizes lifting of dust from the ground. It is most useful on the windward side of buildings especially when highways, open lots, or parking lots are located nearby.

4.3.5.2 Reducing Sound Levels. Mixtures of deciduous plants and evergreens reduce sound more effectively than deciduous plantings alone; however, vegetation has a relatively small effect on sound levels.

4.3.5.3 Visual Screening. Vegetation can also be planned to provide visual screening for privacy requirements as long as it does not interfere with the design for effective ventilation.

4.4 Building Form

4.4.1 General Principles. Building orientation will determine the intensity of solar radiation falling on the walls and roof of the building, and the ventilative effectiveness of the building openings. Building shape determines the amount of exterior surface area for a given enclosed volume and the length of the interior path of the ventilation air. Together, these factors determine the relative amount of thermal transfer through the building envelope and the potential effectiveness of a design to provide cooling by natural ventilation.

Although building shape and orientation are important in minimizing unwanted solar gain, it is possible to counteract some of this gain or partially compensate for improper orientation and shape with the design of the building envelope. Such design measures include light-colored wall surfaces, locally shaded windows, extra insulation, wingwalls, etc. Likewise, it may be

Table 1		
Reflectance Values of Various Ground Covers		
Material	Reflectance (%)	
Light sand dunes	30-60	*
Soil, sandy	15-40	*
Soil, dark cultivated	7-10	*
Green grass, meadow	20-30	*
Dry grass	32	*
Woods, bushes	5-20	*
Bark	23-48	*
Water surfaces, sea	3-10	*
Concrete	30-50	*
Brick, various colors	23-48	*
Blacktop	10-15	*

MIL-HDBK-1011/2

possible to somewhat compensate for poor orientation to the wind by detailed design of the facade and windows, and for poor building shape by the arrangement of the building's interior plan.

4.4.2 Optimal Shape and Orientation

4.4.2.1 Thermal Considerations. In nearly all climates, the optimum shape for solar control is roughly elongated along the east-west axis. See Figure 16. To minimize solar gains, elongate the north and south walls creating an east-west axis. East and west exposures (walls and especially glazing) should be minimized since they are difficult to shade and receive longer periods of direct radiation. South and north exposures are less difficult to shade, especially with roof overhangs. A variation of 15 to 20 degrees from true south has little effect on the thermal performance of small buildings.

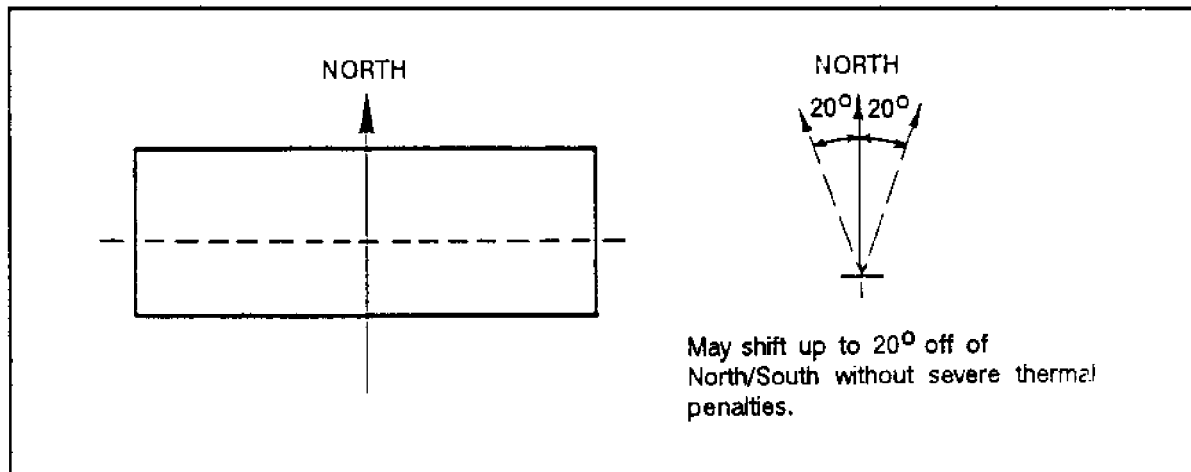

Figure 16
Building Orientation and Solar Heat Gain

The optimal elongation depends on climatic conditions. In severe hot-humid climates, extreme elongation (2.5 : 1 ratio) creates a narrow building with a large wind-exposed face for ease of ventilation. In temperate climates, more freedom in building shape and orientation is allowable.

4.4.2.2 Ventilation Considerations. For an elongated building without openings, the largest pressure differences (which drive cross-ventilation) occur when the building is perpendicular to the prevailing wind. However, this orientation does not necessarily result in the best average interior velocity rates or airflow distribution. For bodily cooling, the goal is to achieve the highest average room velocity in which air movement occurs in all occupied parts of the room.

When windows are in adjacent walls, the optimum ventilation occurs with the long building face perpendicular to the wind, but a shift of 20 to 30 degrees from perpendicular will not seriously impair the building's interior ventilation. This allows a range of orientations for resolving possible conflicts with the optimum solar orientation.

MIL-HDBK-1011/2

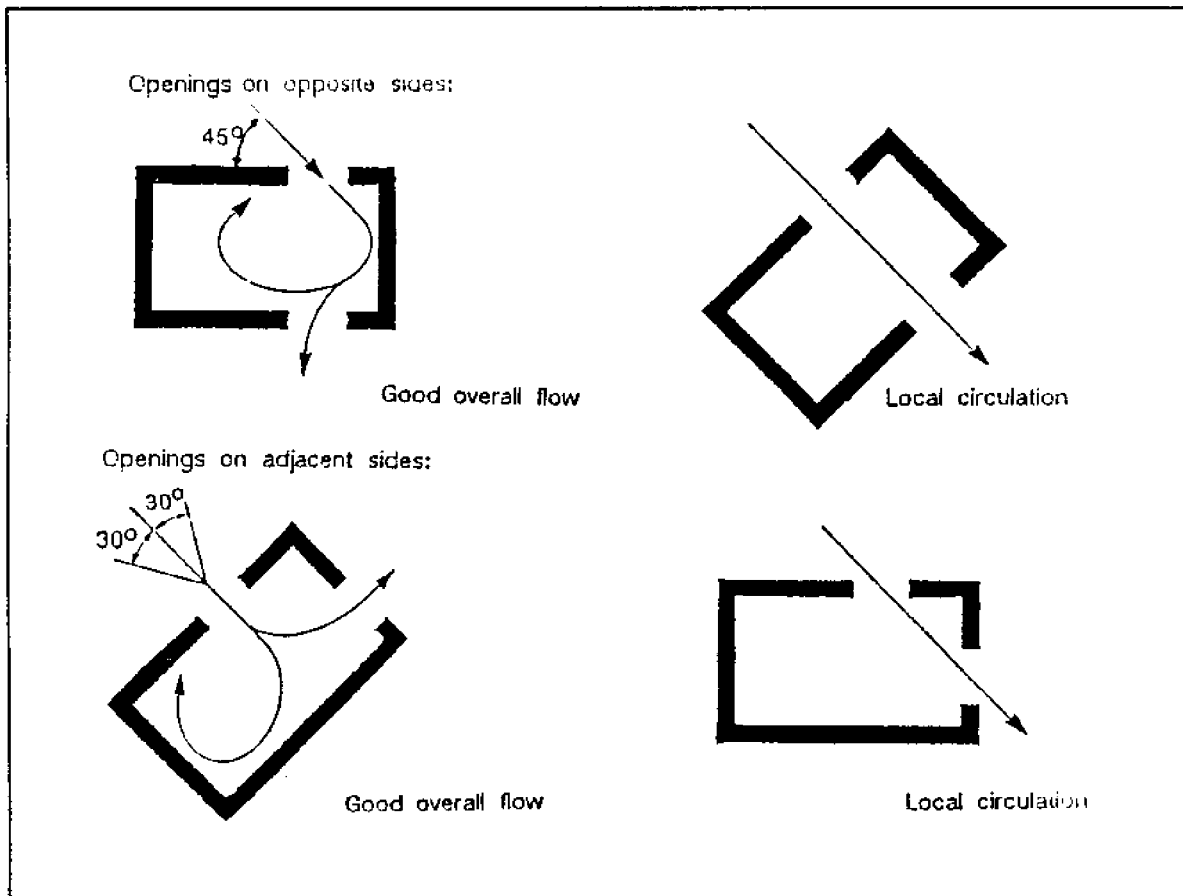

Figure 17
Effects of Wind Incidence Angle on Interior Airflow

Wind approaching at an incidence angle of 45 degrees results in interior velocities that are 15 to 20 percent lower than when the wind approaches perpendicular to the face (see Figure 17).

When windows are in opposite walls, a 45-degree incidence angle gives the maximum average indoor air velocity and provides better distribution of indoor air movement. Wind approaching at 90 degrees is 15 to 20 percent less effective. Wind parallel to the ventilation face produces ventilation depending entirely on fluctuations in the wind and is therefore very uncertain (see Figure 17 and para. 4.5.4).

4.4.2.3 Resolving Conflicts between Thermal and Wind Orientations. Where optimal solar orientation and wind orientation are opposed, solar considerations usually take precedence. In general, inlets for natural ventilation can more easily be designed to accommodate for less than optimal wind orientations than solar control devices (see Figure 17). This is especially true in highrise buildings where orientation to reduce solar gains is most important. However, if the building is low-rise, well-insulated, has a light external color and has effectively shaded windows then the change in

MIL-HDBK-1011/2

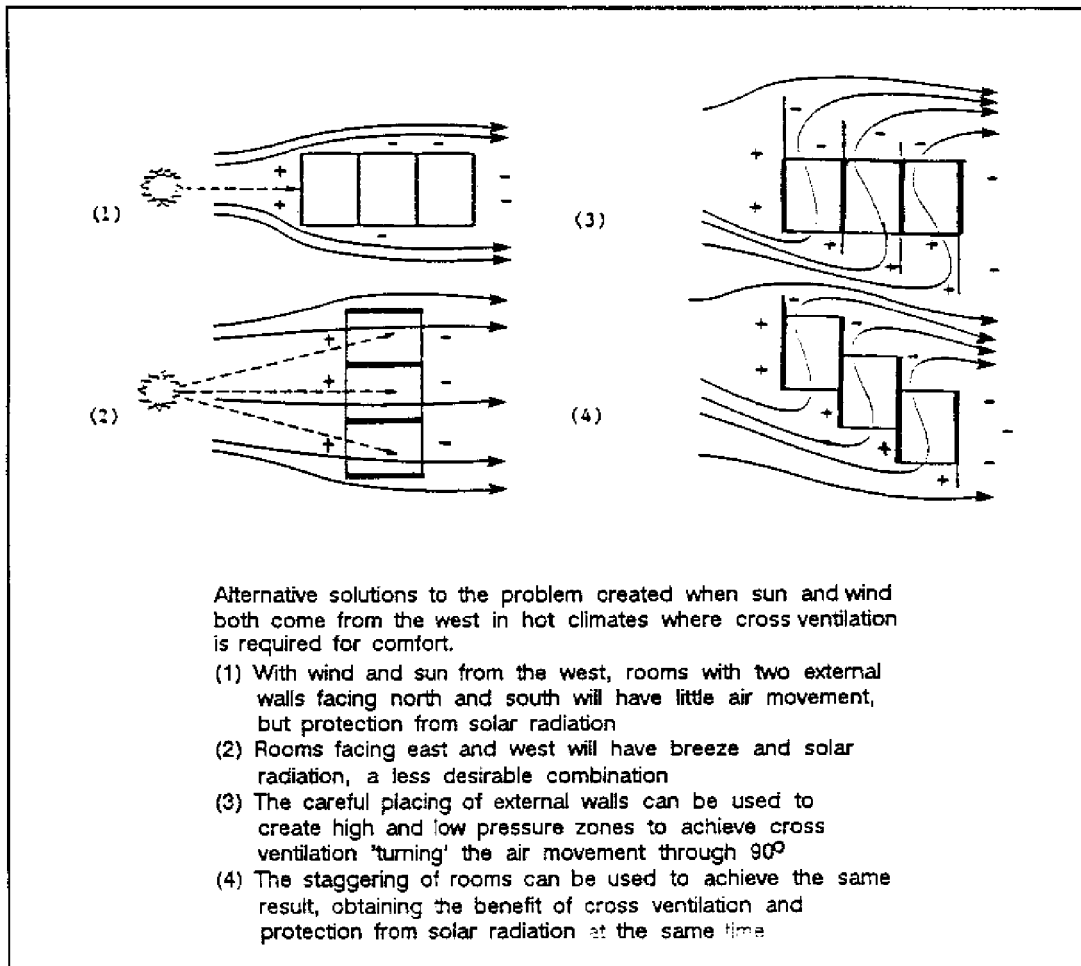

Figure 18
Resolving Conflicts Between Thermal and Wind Considerations

internal temperature with respect to orientation may be negligible. In such cases, ventilation has a greater effect on the internal conditions and orientation with respect to winds should take precedence.

4.4.3 Elevated Buildings. Buildings elevated on columns or lateral walls can have an increased ventilative potential of up to 30 percent over that of buildings on grade. Wind velocity increases with increasing height above the ground; elevating the building raises it to an area of greater free wind speeds.

Elevated buildings also allow for inlets in the floor of the structure which can permit cool, shaded air to enter the building from below. This design is common in hot, humid climates where floors are elevated to reduce structural rot. When situated next to water, elevated buildings can

MIL-HDBK-1011/2

allow cooler air that has passed over the body of water to enter the building from below. Elevating the building may also be worthwhile if the ground is continually damp or when the building is located in a flood plain.

Airflow beneath a highrise elevated building may be accelerated beyond a level which is comfortable or safe for pedestrians. Refer to Appendix A, para. 3.3.3.

4.5 Building Envelope and Structure

4.5.1 General Principles. The building materials and type of construction used will have a significant effect on the heat gain and heat loss characteristics of the building. For naturally ventilated buildings, lightweight materials with light-colored, heat-reflecting outer surfaces are desirable. The major building components of the structure are the roof, which provides shade and protection from the rain, and the fenestration system, which determines the volume, velocity and distribution of interior ventilation.

4.5.2 Roof and Roof Ventilators

[retrieve figure]

4.5.2.1 Roof Overhang Effects on Room Ventilation. Roof overhangs can enhance ventilation by damming the airstream in a pocket at the wall thereby increasing the positive pressure outside the window and consequently the airflow through the opening (see Figure 19).

Figure 19
Roof Overhand and Room Ventilation

4.5.2.2 Roofs--Thermal Considerations. Roofs receive the most solar radiation of any building surface and are the primary protection from direct radiation in low-rise buildings. The amount of solar radiation falling on the surfaces of a building varies with latitude, season, time of day and building orientation. Figure 19 shows the relative solar intensities throughout the day for each building surface for 26MN. latitude for each season.

Use light coloring on the roof to reflect solar gain. Effective insulation, including the use of radiant barriers above resistive insulation, is critical to ensure comfort in spaces below the roof (see Figure 21). Attics above living spaces need to be independently ventilated. As roof pitch decreases, the temperature of the ceiling below can be expected to rise. Also, ventilation of the attic space becomes progressively more difficult. Attic ventilation should be designed so that openings are provided in both positive and negative pressure areas to provide proper cross-ventilation. Refer to Appendix A, Section 3.) When venting attic spaces, be careful to place exhaust outlets so that hot air is not blown into occupied spaces or near air inlets.

MIL-HDBK-1011/2

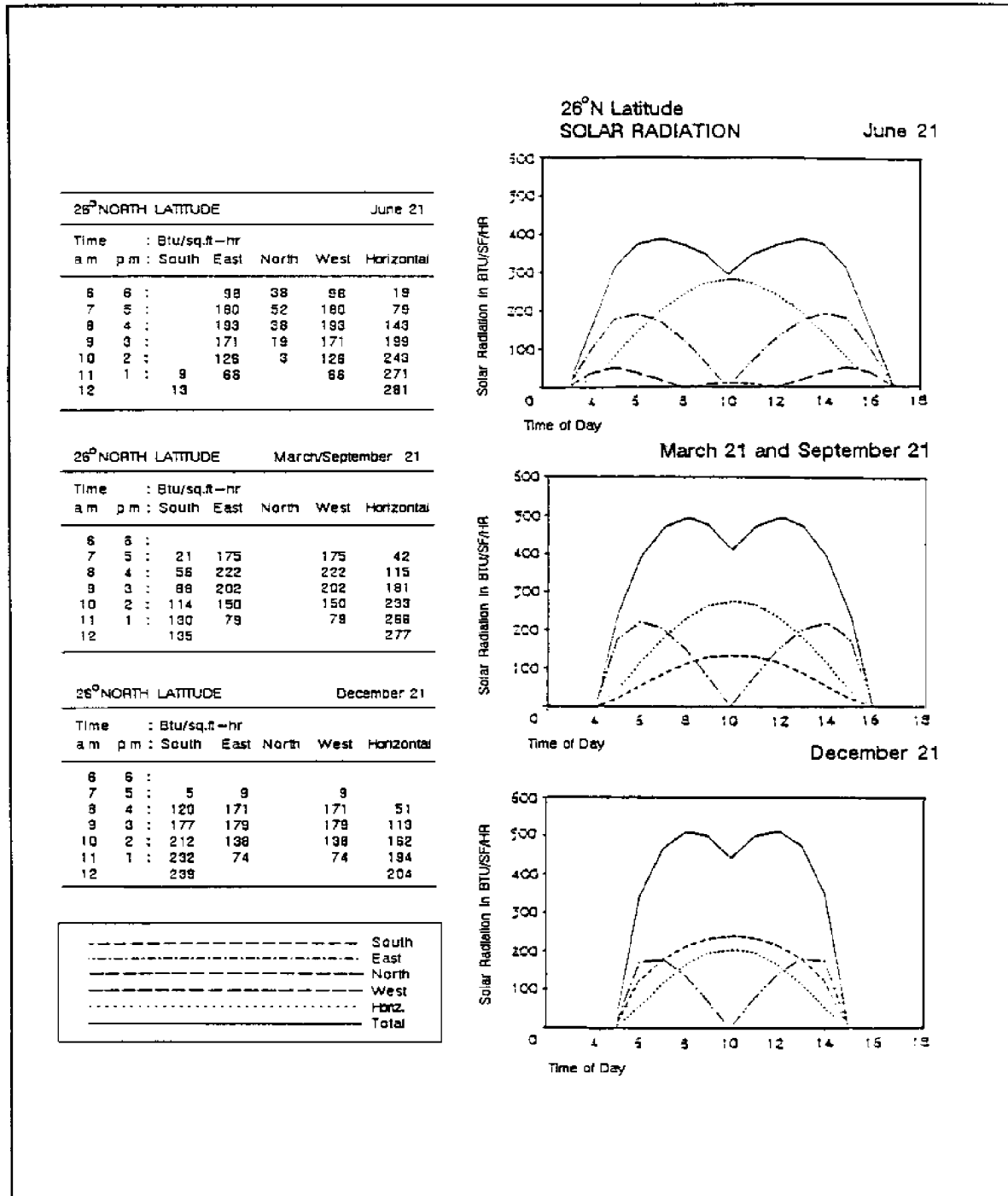

Figure 20
Direct Irradiation Values in Btu/Ft²/Hr for 26°N Latitude

MIL-HDBK-1011/2

Overhanging eaves may provide necessary solar shading for windows and building surfaces. Refer to para. 4.2.3.1.

Figure 21
Attic Section with Three Possible
Locations for a Radiant Barrier

4.5.2.3 Ventilators. Higher indoor air movement can be obtained with proper cross-ventilation than with roof openings. Therefore, roof ventilators should not be considered as alternatives to proper wall openings but should be used in conjunction with proper wall openings to obtain well ventilated interior spaces. Only part of the windward slope of a steeply pitched roof is under positive pressure. Low pitched and flat roofs are subject to suction over their entire areas when:

$$\text{EQUATION:} \quad X = < 1.2 \text{ length} \\ \text{))))))))) \\ \text{feet}$$

where:

length = Length of the building in the windward direction

X = Area of the windward face

Under these conditions a stagnant zone exists over the entire roof due to flow separation occurring at the windward eave. The result is that the entire roof is more or less under suction and is a good location for exhaust outlets. With high pitched roofs and when the building length is greater than 1.2 times the area of the windward face, the stagnant zone exists mainly downstream from the ridge while a portion of the windward side of the roof is under positive pressure. The critical roof pitch at which the point of flow separation is displaced from the windward eave to the ridge depends to a large extent on the wall height but may be taken between 18 and 25 degrees for wall heights from 12 to 15 ft (3.6 to 4.6 m) respectively (see Figure 22).

4.5.2.4 Ventilator Placement. Use the strong negative pressure areas near the ridge as exhaust locations. Placement of exhaust openings on high pitched roofs is more critical because of possible positive pressure zones, which should be avoided. Ventilators or wind scoops with openings facing the wind can act as effective inlets but water infiltration must be considered in their design and location. Possible problems with privacy, rain, and noise from ventilators must be identified and resolved.

4.5.2.5 Ventilator Performance. Wind tunnel studies have shown that the performance of common turbine roof ventilators is only slightly better than that of an uncapped pipe. All other tested pipe designs proved more effective than the turbine type. The highest performance for a simple ventilator was produced by placing a canted flat plate over the pipe (see Figure 23).

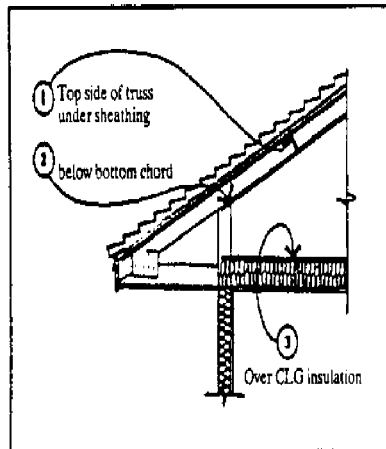

Figure 21
Attic Section with Three Possible
Locations for a Radiant Barrier

MIL-HDBK-1011/2

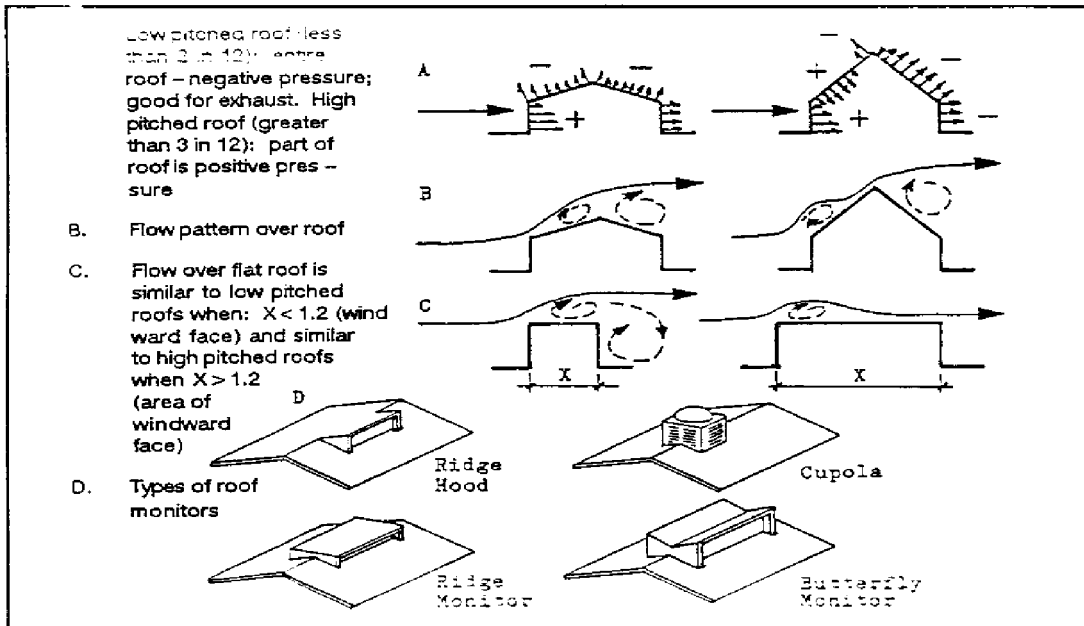

Figure 22
Effects of Slope on Roof Pressures and Ventilation Characteristics

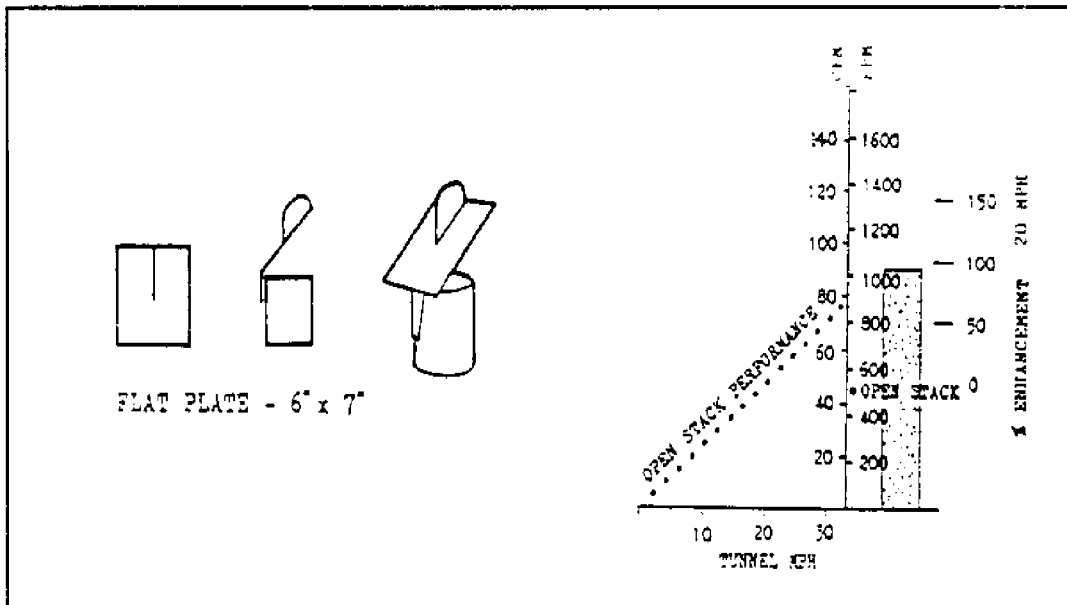

Figure 23
Roof Ventilators--Performance of Simple Flat-Plate Ventilators

MIL-HDBK-1011/2

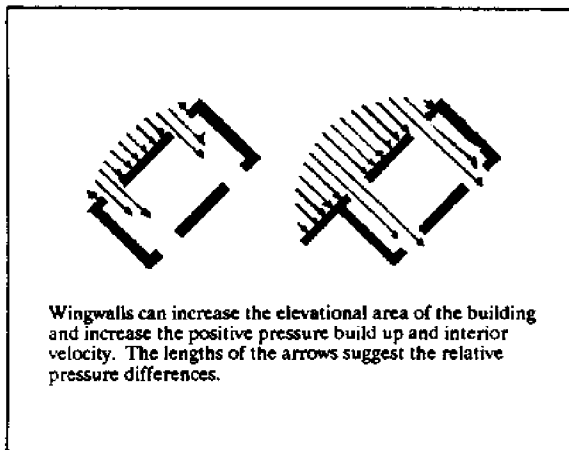

Figure 24
Effect of Wingwalls

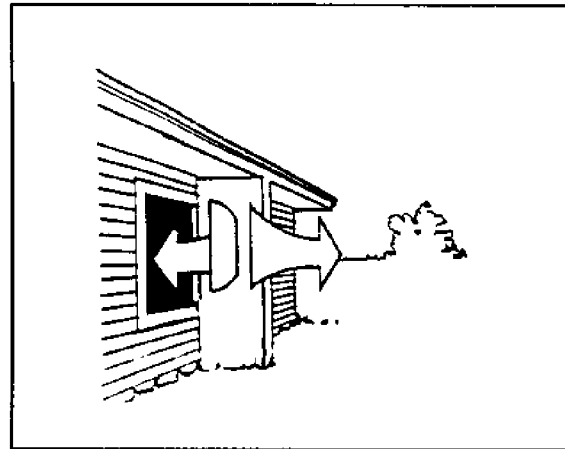

Figure 25
Wingwall Acting as Air Flow Diverter

4.5.3 Wingwalls. Wingwalls or exterior vertical fins can increase a building's ventilative potential by catching and deflecting winds into the interior. Properly designed wingwalls may also provide solar shading by acting as vertical fins on east and west elevations. Refer to para. 4.5.6, Solar Control--Shading Devices.

4.5.3.1 Ventilative Considerations. Wingwalls can increase interior ventilation rates when the wind incidence angle is perpendicular to the building face. Placement of wingwalls to the side, or parapets on top of the building increases the area of the windward facade creating higher positive pressures and resulting in higher interior velocities, (see Figure 23).

Wingwalls can also be used to intercept and increase the admittance of oblique breezes into the building. Wingwalls placed perpendicular to the building facade can create air dams that "trap" and redirect air into the building (see Figure 25).

4.5.3.2 Improving Cross Ventilation. One of the most useful effects of wingwalls is the creation of cross-ventilation in rooms with windows on one wall only or in rooms without positive pressure inlets and negative pressure outlets. Proper placement of wingwalls can create positive and negative pressure which drive ventilation in otherwise stagnant rooms (see Figure 26).

Wingwalls can improve ventilation in rooms with openings only on the windward side, but are effective only if they create positive and negative pressure zones. They cannot improve ventilation in rooms with openings on the leeward side only.

For ventilation with openings in one wall only, up to 100 percent improvement of the interior airflow and air change rate may be achieved. Wingwalls do not significantly enhance ventilation in cross-ventilated rooms with openings on opposite walls unless the wind incidence angle is oblique. For oblique wind angles (40 to 60 degrees), wingwalls can increase average interior velocity by up to 15 percent.

MIL-HDBK-1011/2

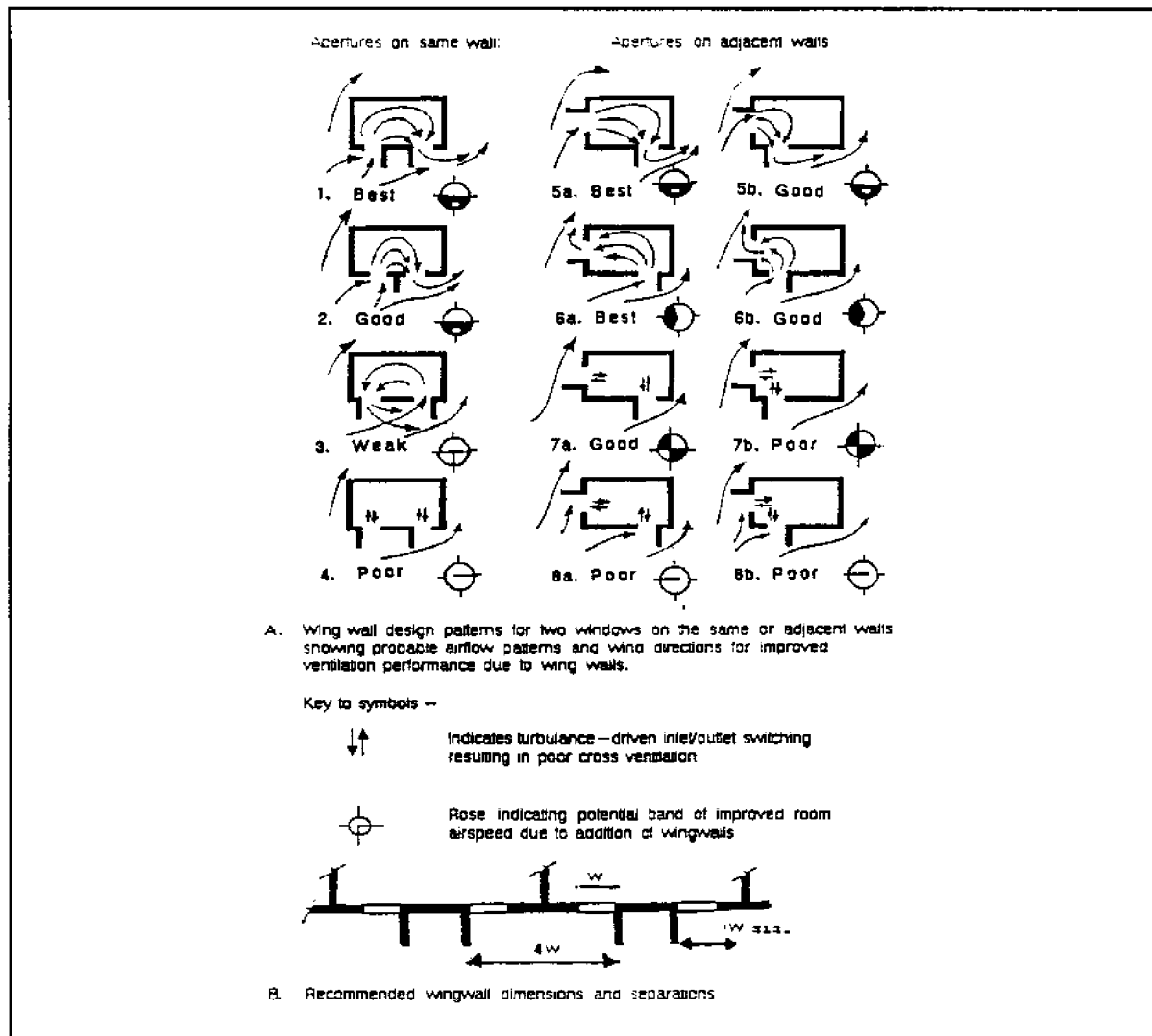

Figure 26
Wingwall Designs and Their Effects on Interior Air Flow Patterns

4.5.3.3 Placement and Size. Wingwalls from the ground to eave on small scale buildings are effective for wind incidence angles from 20 to 140 degrees. Wingwalls can be thicker than shown in the preceding figures. Projecting bathrooms, closets, entrances or other architectural features may serve as "wingwalls."

4.5.3.4 Thermal Considerations. Wingwalls may also serve as solar shading devices, and are especially useful on southeast and southwest facades. Refer also to para. 4.5.6.

MIL-HDBK-1011/2

4.5.4 Windows

4.5.4.1 Ventilation Considerations. As the wind blows onto and around buildings it creates regions in which the static pressure is above or below that of the undisturbed airstream. (Refer to Appendix A, Section 3.) Positive pressure on the windward side forces air into the building, and negative pressure on the leeward side pulls it out of the building. Pressures on the other sides are negative or positive depending on the wind incidence angle and the building shape. The rate of interior airflow is determined by the magnitude of the pressure difference across the building and the resistance to airflow of the openings. The size, shape, type and location of the openings, especially the inlets, determine the velocity and pattern of internal airflow.

When designing and placing windows and openings for ventilation the following factors must be considered:

- a) Predominant external wind and directions when the winds occur.
- b) Construction of the building envelope and landscaping may hinder or facilitate natural ventilation of the interior spaces.
- c) Location and type of inlets has the largest effect on the airflow pattern through the space.
- d) Location and outlets type has little effect on airflow pattern.
- e) Number of airchanges per hour has little to do with body cooling; the airflow velocity and distribution pattern are more important.
- f) Changes in indoor airflow direction tend to retard airspeed.

4.5.4.2 Cross Ventilation. Cross ventilation provides the greatest interior velocities and the best overall air distribution pattern. Openings in both positive and negative pressure zones are required for cross ventilation (see Figure 27). For windows on adjacent walls, the overall room air distribution is best (10 to 20 percent higher average velocities) when the wind incidence angle is perpendicular to the building face. For windows on opposite walls, oblique wind incidence angles give 20 to 30 percent higher average velocities than perpendicular winds. See Figure 17 and para. 4.4.2.2.

4.5.4.3 Windows on One Wall. When windows are restricted to only one surface, ventilation will usually be weak, and is independent of the wind direction. Average internal wind speed will not change significantly with increasing window size. One-sided ventilation can be made effective when two openings are placed on the windward face, the wind angle is oblique (20 to 70 degrees), the windows are as far apart as possible and if deflectors such as wingwalls are used (see Figures 26B and 28).

4.5.4.4 Expected Interior Airspeeds. Indoor airspeeds, even under the most favorable conditions, are only 30 to 40 percent of the free exterior wind speed in cross-ventilated spaces, 5 to 15 percent of the free exterior wind speed in rooms with openings in one wall only and only 3 to 5 percent in rooms with one opening.

MIL-HDBK-1011/2

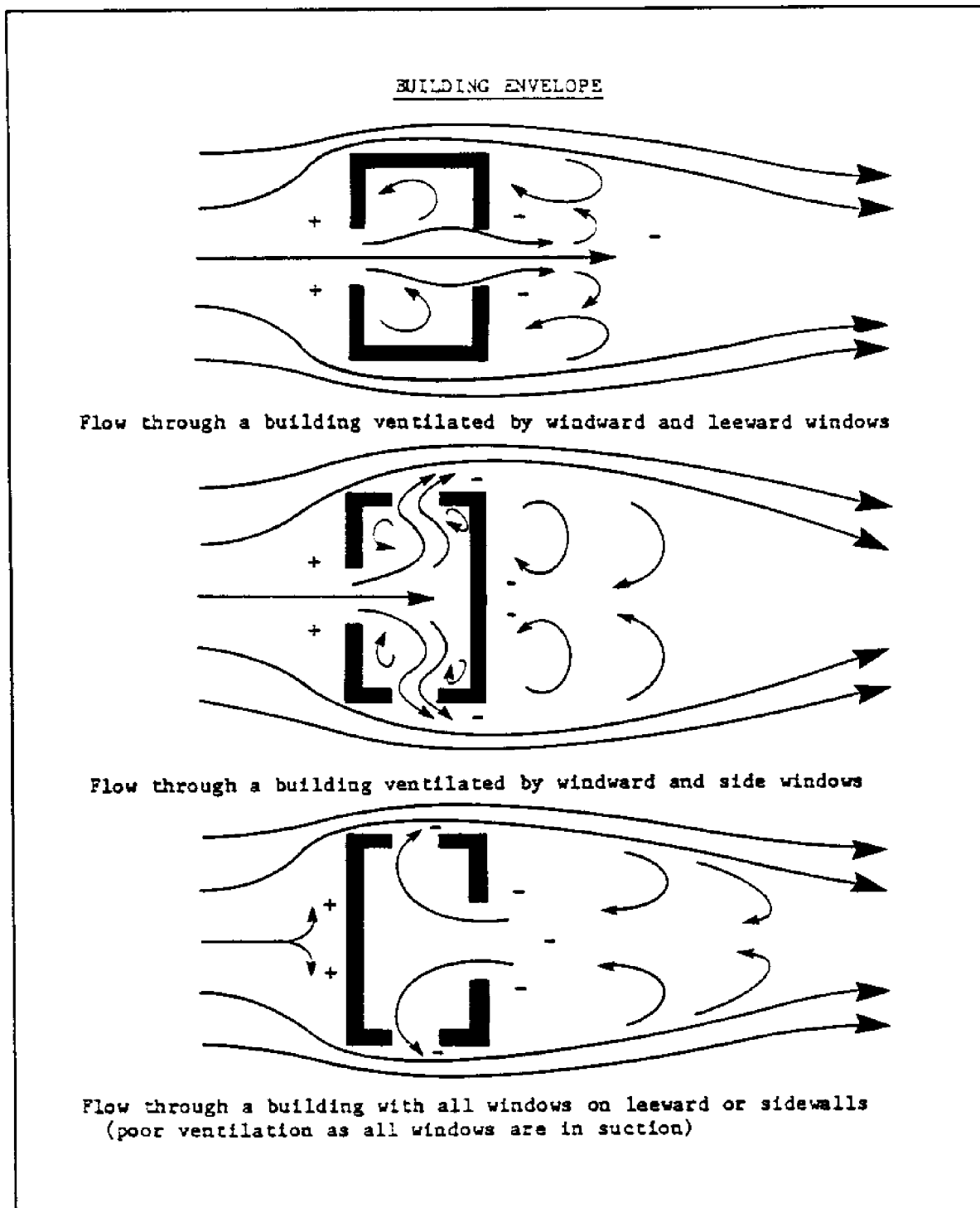

Figure 27
Air Flow Patterns and Pressure Zones

MIL-HDBK-1011/2

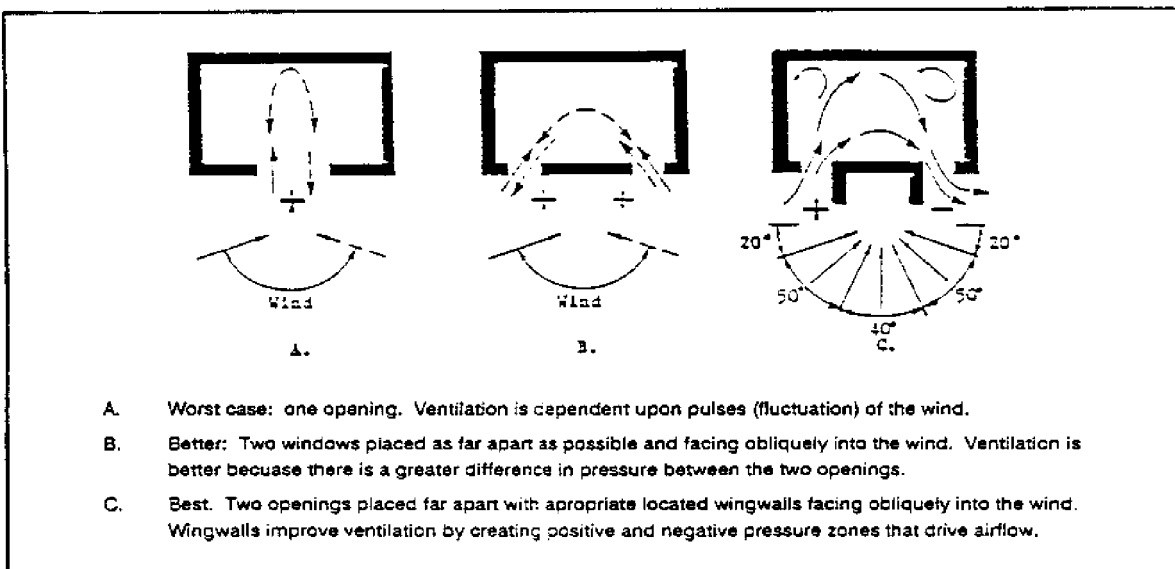

Figure 28
Ventilation in Rooms with Openings in One Wall

4.5.4.5 Effect of Exterior Conditions. The spaces between buildings will condition the air before it enters through building openings. If possible, the airflow approaching the building inlet should not pass closely over a large hot surface (such as a sunlit asphalt parking lot) which will heat the incoming air.

4.5.4.6 The Vertical Location in the Wall. The stack effect in most residential buildings is negligible and completely overwhelmed by even modest wind effects. If stack ventilation is used, openings must be placed both low and high in the building. While the movement of air as a result of the stack effect may be adequate for fresh air supply, it is rarely sufficient to create the appreciable air movement required in hot zones to provide thermal comfort. Schemes that attempt to create forced stack ventilation by heating mass within the stack should not be used.

For wind-driven ventilation, outlet height has little influence on interior airflow, but inlet height has a great effect on the airflow pattern in the room. Positive pressures built up on the windward face of the building can direct the airflow up to the ceiling or down to the floor of the room. These positive pressures are related to the area of the windward face. Thus, a window located high on the wall directs airflow up to the ceiling because the positive pressure built up on the building face is larger below the window than above it (see Figure 29).

There is usually an abrupt drop (up to 25 percent) in airspeed below the level of the inlet sill (see Figure 29). The sill height may significantly alter the air velocity at certain levels while only slightly affecting the average airspeed in the whole room. Therefore, for body

MIL-HDBK-1011/2

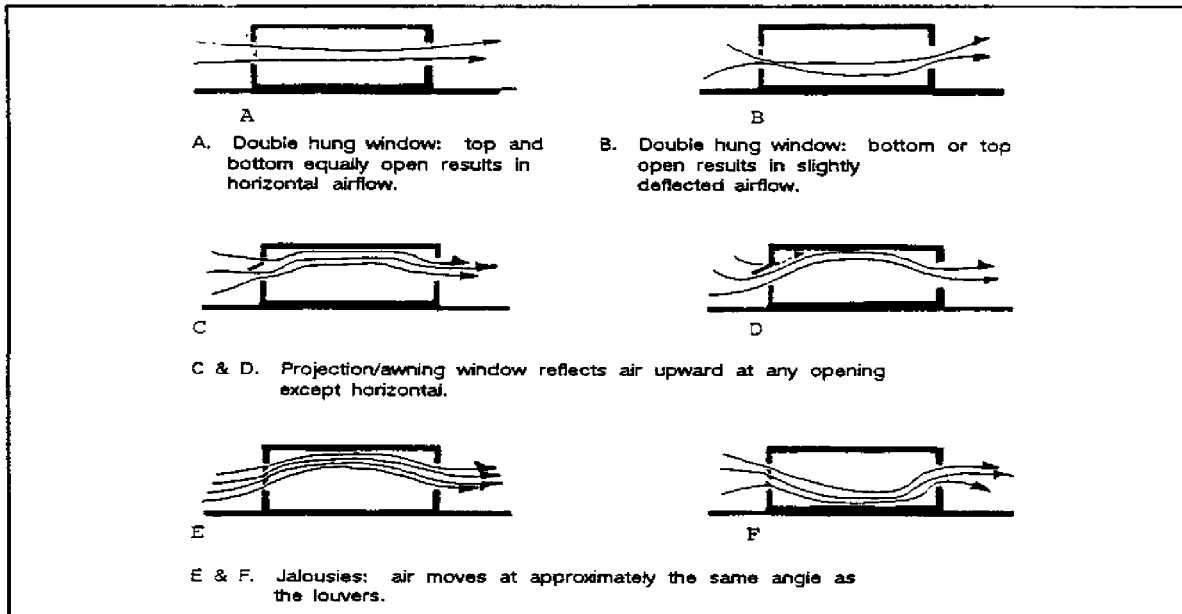

Figure 29
Air Flow Patterns Through Single Banked Rooms
for Various Openings and Partitions

cooling, the best location for windows is at or below body level. Remember that body level changes with room use; body level in bedrooms is at bed height, while body level in offices is at sitting height.

Vertical placement is also affected by window type since different window types produce different airflow patterns.

4.5.4.7 Window Type. Table 2, in association with Figure 31, provides data pertaining to the effects of various window types on airflow.

4.5.4.8 Window Shape. Window inlet shape is the most important factor in determining the efficiency of wind cooling. The horizontal shape is the best at capturing and admitting winds for more angles of wind incidence. A horizontal window performs better than both square and vertical windows in perpendicular winds, and improves its

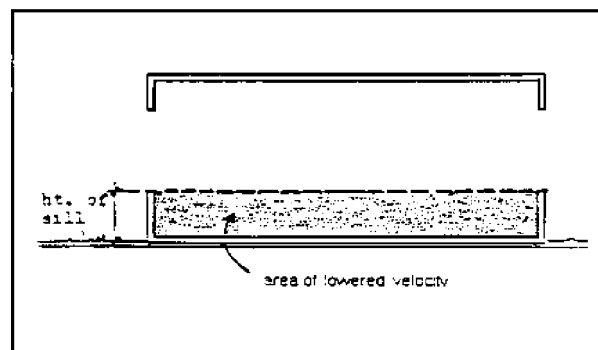

Figure 30
Effect of Sill Height on
Air Flow and Velocity

MIL-HDBK-1011/2

Table 2
Window Type and Interior Airflow Characteristics

*Window Type	Interior Airflow	Max Open Area(%)	Recommendations for Natural Ventilation
*Double hung/ *horiz. sliding	Horizontal in same direction as outside airflow. Some air leaks between panes.	50	Should be located at level and directly in front of the zone where airflow is desired.
*Vertical pivot *or casement	Horizontal control of airflow. Air flows between open sash and frame and over top and bottom of open sash.	50-90	Effects similar to wingwalls. Use at the level that airflow is desired.
*Horizontal *projection or *awning	Upward unless fully open.	50-90	Best placed below zone where airflow is desired.
*Jalousie or *central pivot	Vertical control of airflow. Airflow at about same angle as louvers.	60-90	Good placed at any height. Cannot be fully sealed. Maximum vertical control.

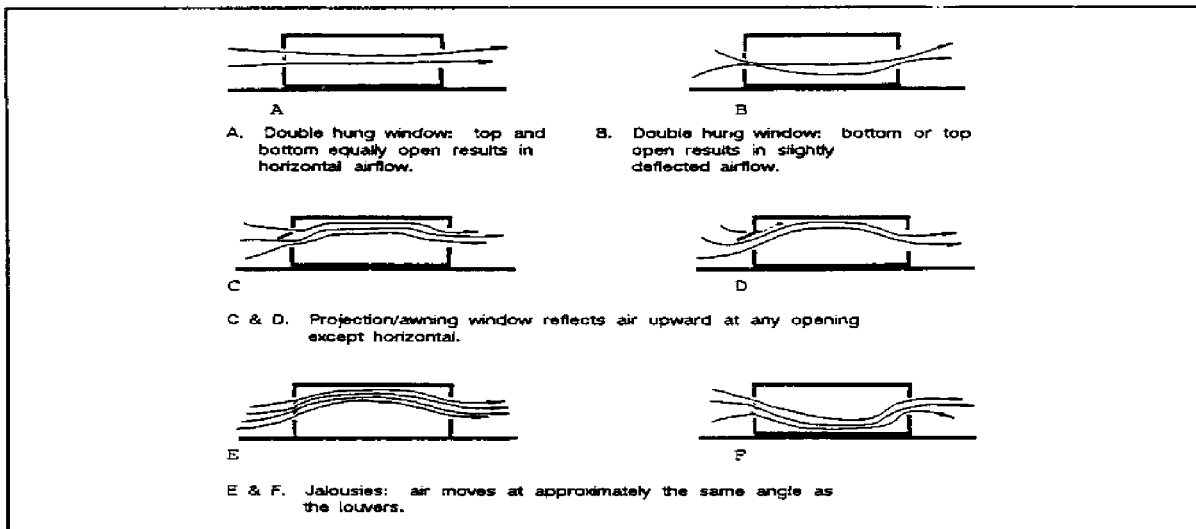

Figure 31
Air Flow Patterns Through Single Banked Rooms for Various Window Types

MIL-HDBK-1011/2

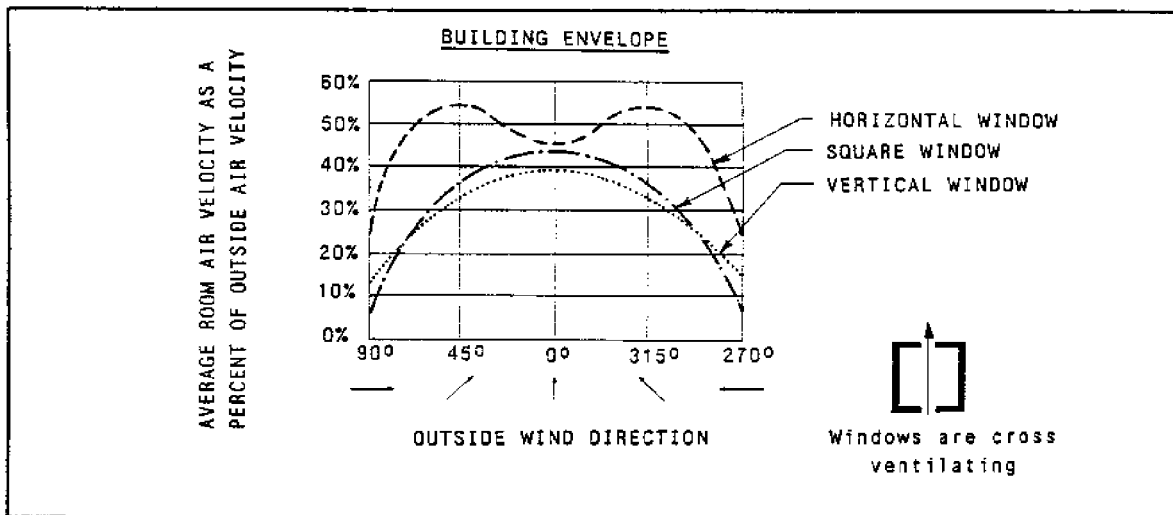

Figure 32
Window Shape Performance in Relation to Wind Direction

effectiveness in winds with a 45-degree incidence angle (see Figure 32). The optimal shape has been found to be eight times as wide as tall, however smaller width-to-height ratios are also effective.

Square and vertical shapes exhibit peak performance in perpendicular winds. If the wind incidence angle is confined to a narrow band and openings can be placed perpendicular to the wind, then square openings will also work effectively. However, if the wind incidence angle varies, then horizontal openings will work more effectively under a greater variety of conditions and should be used. Tall openings exhibit a lower effectiveness than both horizontal and square shapes for all wind incidences.

4.5.4.9 Size. The effect of window size depends on whether or not openings are cross ventilating. If openings are on one surface only, size has little affect on airflow. In cross ventilated rooms, airflow is determined mainly by the area of the smallest openings; average indoor velocity and number of air changes is highest when inlet area is equal to or slightly less than outlet area as in Equation 1.

$$\text{EQUATION:} \quad \text{outlet area/inlet area} = 1.25 \quad (2)$$

Ventilation is more efficient for a greater number of incidence angles when inlets larger than the outlets. If concentrated flow in a restricted area of the room is desired, the inlets may be sized smaller than the outlets and placed immediately adjacent to the living space to be ventilated (see Figure 33). In general, use the largest area of openings possible with inlet area equal to or slightly less than outlet area. To determine the size of windows necessary to obtain a given air change rate, refer to Appendix C, Section 1.

MIL-HDBK-1011/2

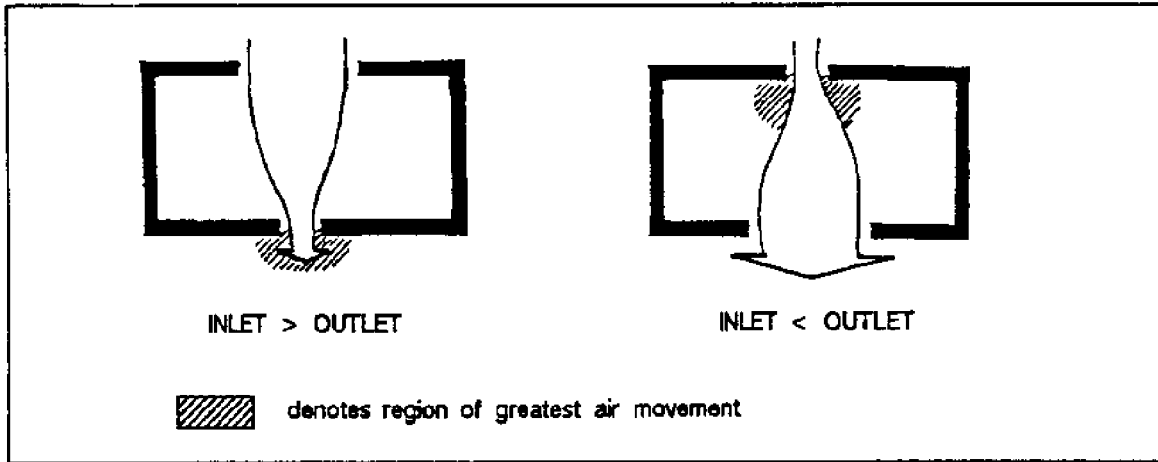

Figure 33
Effect of Relative Opening Size on Airflow

4.5.4.10 Insect Screening. Insect screening decreases the ventilative effectiveness of openings. The amount of decrease in velocity varies with screen type and the incident wind direction and velocity. Decreases in velocity are greater with lower windspeeds and oblique winds, and can be as high as 60 percent (refer to Table 4).

Because insect screening lowers the effectiveness of the openings for ventilation, its presence must be factored in when sizing windows. In the window sizing procedure in Appendix C, Section 1, a porosity factor is used to lower the opening's ventilative effectiveness when screens are used.

If possible, place insect screening across the larger area at the front of the balcony rather than at each opening (see Figure 34). This creates less resistance to airflow and results in greater interior velocities.

Table 3
Reduction in Wind Velocity Due to Insect Screens
As a Function of Incidence Angle

* Outside Velocity		* Normal Incidence			* 67.5 degree incidence		
* m/s	* fpm	* m/s	* fpm	* %	* m/s	* fpm	* %
* 0.75	150	0.49	98	35	0.40	80	47
* 1.23	250	0.87	178	29	0.75	153	39
* 2.50	500	1.33	267	47	1.00	200	60
* 3.30	650	1.79	353	47	1.33	262	60
* 3.80	750	2.64	520	31	2.23	438	42

MIL-HDBK-1011/2

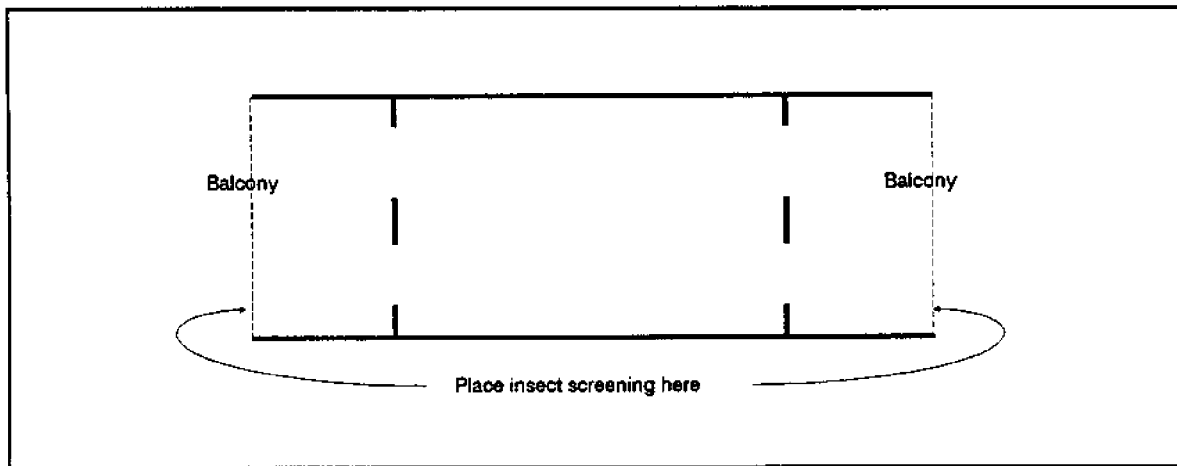

Figure 34
Best Location for Insect Screening

Screens should be located in all areas where insects, rodents, or birds could prove to be an annoyance or damage the contents of a room. Unless the specific requirements of the local environment dictate otherwise, 14-wire screen should be used. This allows greater interior airflow than higher density mesh and should prevent most insects from entering the building. It is possible in highrise buildings to eliminate screens on the upper floors (above four stories) if the designer and Activity mutually agree to its acceptability.

When a building is located adjacent to a highway, parking lot, or other dusty area, screens may assist in reducing the infiltration of windborne dust, dirt, and other debris. The use of screens for this purpose, however, must not interfere with requirements for adequate ventilation. Screens should be maintained on a regular basis.

4.5.4.11 Thermal Considerations. Windows usually contribute the major portion of solar heat transmission into a building. For minimum solar gain, openings should be located primarily on the north and south sides rather than the east and west sides, and all openings shall be completely shaded between 8 am and 6 pm solar time during the cooling season to minimize heat gain (refer to para. 4.5.6).

Separation of the light-admitting, view, and ventilating purposes of windows may be advantageous (refer to para. 4.5.5).

4.5.5 Separation of Functions. It is possible to separate the light-admitting (and therefore heat-admitting) and ventilating purposes of windows, so that there can be larger inlet and outlet areas with lower total solar gain. This separation is especially useful in tradewind areas where the predominant wind directions, from the northeast to southeast, are difficult to shade effectively. It may be preferable to use shaded, opaque openings for ventilation on the easterly exposures and separate glazed windows for view and daylight on the north and south facing exposures, which may or may not be operable as well.

MIL-HDBK-1011/2

4.5.5.1 Wind Admitting Devices. Wind-admitting devices which exclude solar light and heat include opaque or reflective louvered windows or walls and opaque sliding or pivoting window or wall panels. A wall may also consist of a combination of window types which may be used alone or in combination to provide ventilation, view, or privacy or to provide protection from the sun or rain (Figure 35). One such combination wall might consist of:

a) a sliding glass panel which provides view and light while eliminating air, dust, insects and rain.

b) a sliding panel of opaque louvers for providing ventilation air while protecting from the sun and light rains (Insulated opaque panels may also reduce the outward flow of heat in winter or at night when ventilation for cooling is not desired.)

c) a sliding panel of insect screening for providing air while eliminating insects.

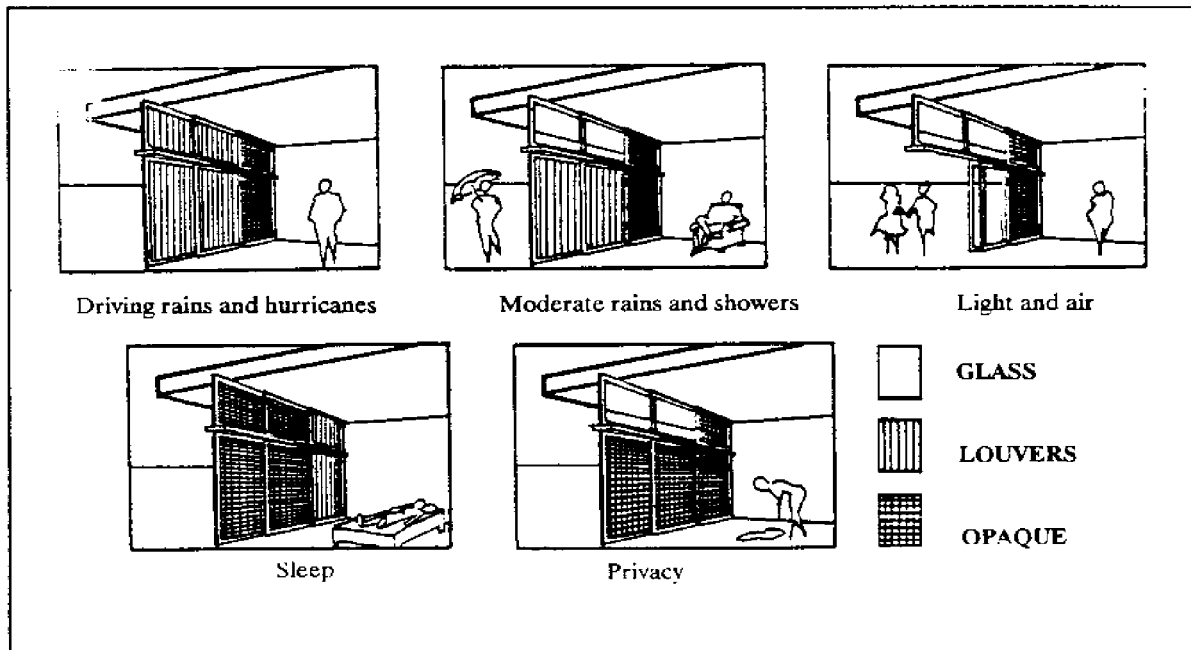

Figure 35
Possible Combinations of Wall Systems

Fixed opaque louvers may be used on the lower part of a window wall with operable louvers above for ventilation, light and view. In warm-humid climates such as the tropics, it is important to admit wind for cooling while preventing the admittance of wind driven rain. In *Window and Ventilator Openings in Warm and Humid Climates*, Koenigsberger, Miller, and Costopolous, (1959), reported that only M-shaped fixed louvers satisfy the requirement of keeping the rain out and allowing the breeze to enter without deflecting it

MIL-HDBK-1011/2

upward away from the body in the living space. The M-shaped louvers reduce the velocity of the wind by 25 to 50 percent, with the larger reductions occurring at higher wind speeds. The velocity reductions are equivalent or less than those of other louver types (see Figure 36).

4.5.5.2 Horizontal Shading Devices. A roof overhang is the simplest and most maintenance-free exterior shading device. They are most effective on the south side, but can also be used on the southwest, southeast and north facades. On east- or west-facing walls, overhangs

must be very deep to be effective. The necessary depth may be achieved by the use of an attached covered porch or carport, or by adequately wide exterior balconies. See Figure 37.

Careful detailing of horizontal exterior shades will maintain the ventilation efficiency of the openings. Leave a gap between the shade and the building to prevent airflow from attaching to the ceiling (see Figure 38).

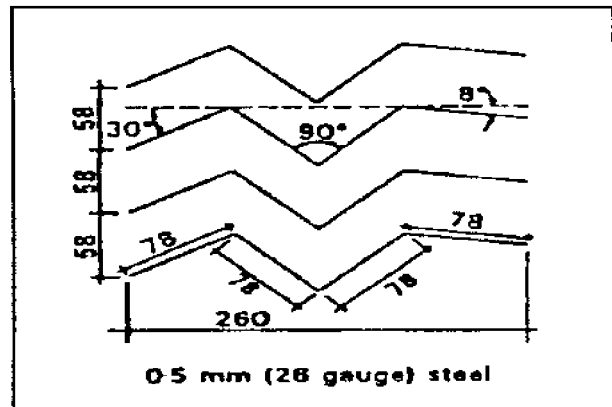

Figure 36
M-Shaped Louvers

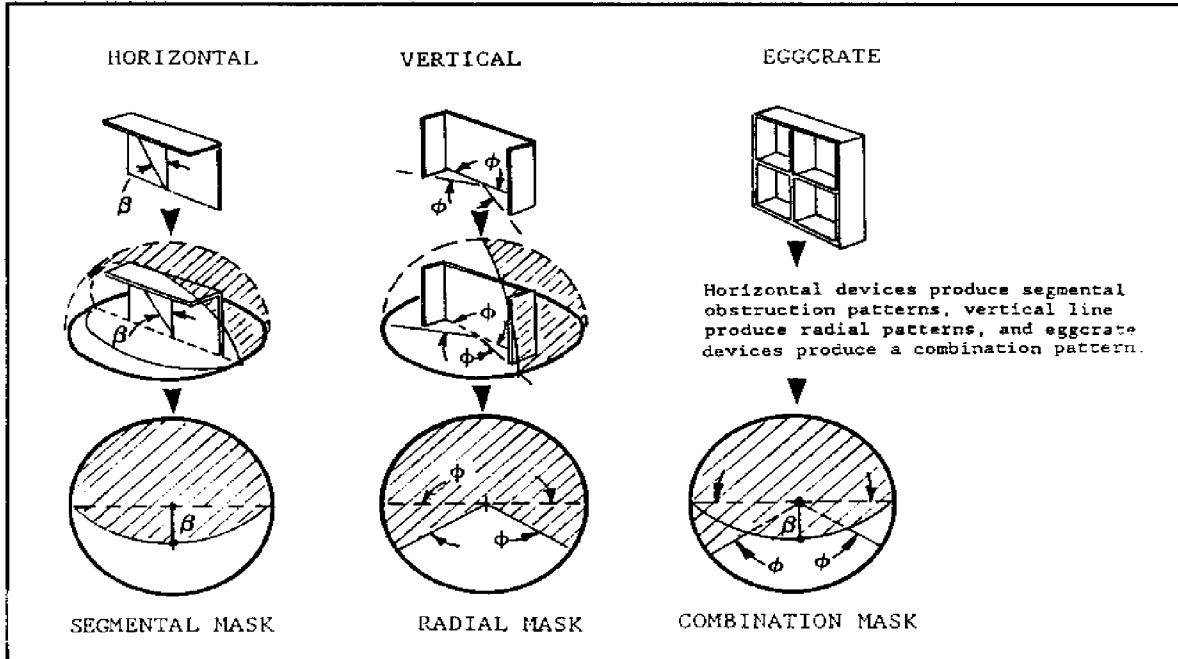

Figure 37
Solar Shading Masks for Overhangs and Side Fins

MIL-HDBK-1011/2

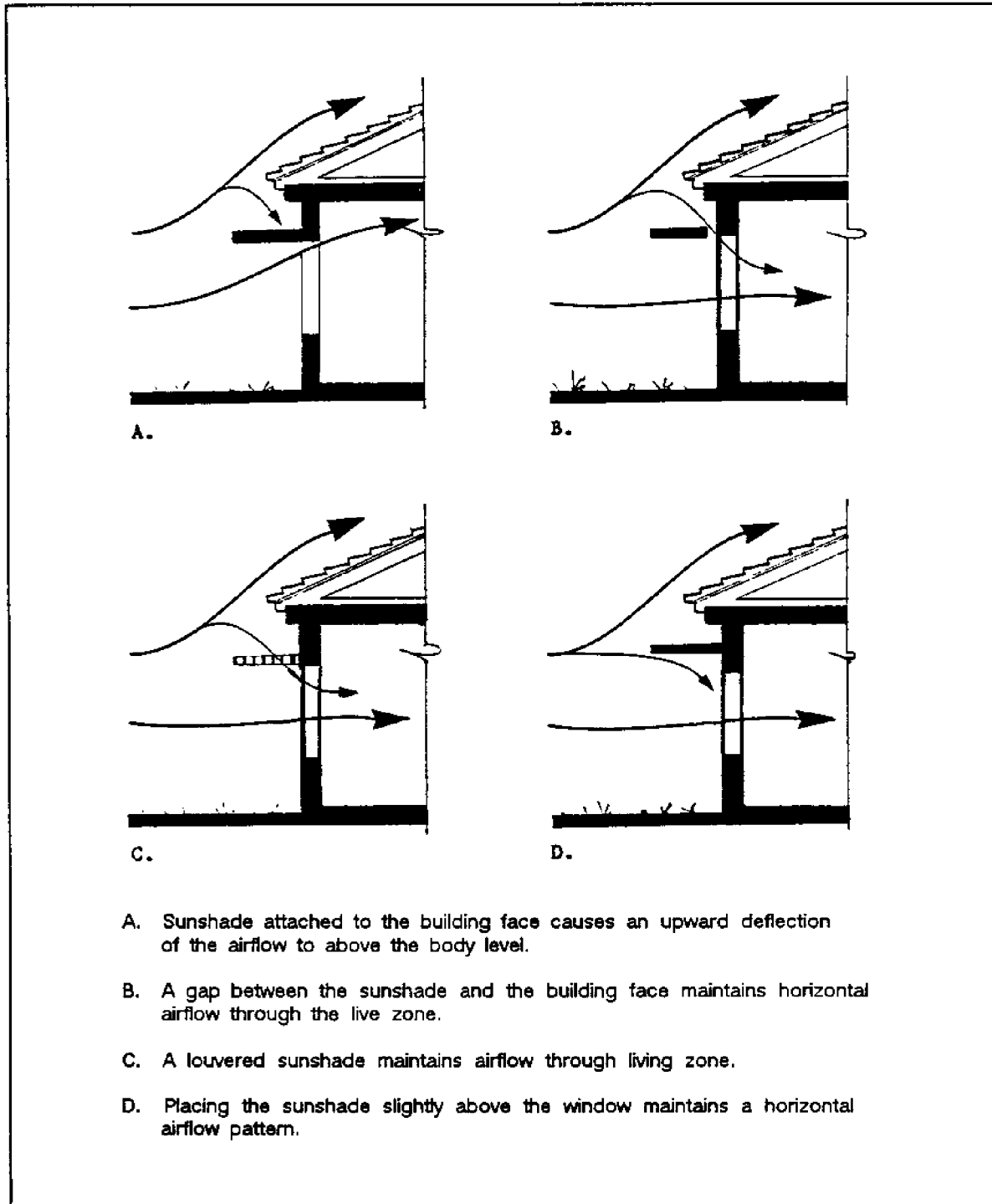

Figure 38
The Effects of Horizontal Exterior Shading on Interior Airflow

MIL-HDBK-1011/2

Placing the horizontal sunshade slightly above the upper edge of the window can also be used to maintain body level airflow. The exact size of the gap or placement of the overhang required depends upon the sunshade and window sizes.

4.5.5.3 Vertical Shading Devices. Vertical fins or wingwalls are the most appropriate shading devices for east and west facing openings which receive sun at low angles, and for southeast and southwest openings in combination with horizontal shading. Wingwalls which increase the ventilative potential of the building may also be utilized for shading if they are properly designed (refer to para. 4.5.3).

4.5.5.4 Other Types. Operable exterior shutters, rolldown shades and blinds can provide effective shading on any facade. They are most useful on east and west openings which are difficult to shade with overhangs or vertical shading devices. The thermal performance of closed exterior shutters depends on how well the heat absorbed by the shade is dissipated to the outside air. For this reason, light-colored reflective shutters are preferred in hot climates. For naturally ventilated buildings, the specification of such devices should be treated with care since air movement to the building interiors is reduced when the shutters or shades are in their closed position. If the operation of the devices is not obvious, provision should be made for mounting instructions nearby.

Site obstructions such as buildings and trees may provide effective building or window shading. Analysis of the site using a sunpath diagram is recommended to determine when such shading occurs.

4.5.5.5 Glazing Type. Each glazing type provides differing amounts of resistance to solar heat gain. Reflective and absorbing glazing types can reduce cooling loads 15 to 30 percent below that of clear glass with some reduction in transmitted light.

Heat-absorbing glazing is less effective than reflective glazing because it absorbs the solar heat into the glass, thereby increasing the heat convected and radiated into the internal space. Better performance can be obtained with either reflective or heat absorbing glazing if they are used as the exterior panel of a double glazed window. In general, clear glazing with effective exterior shading shall be used unless an optional glazing/shading system can be justified in a cost-benefit analysis.

4.5.6 Design Procedure. See the latest edition of Architectural Graphic Standards for details on designing exterior solar shading.

4.5.7 Insulation. Insulation is used in naturally cooled buildings to reduce the amount of solar heat transmitted to occupied areas. The designer shall use the most appropriate and cost effective means of controlling heat gain through the roofs and walls of the structure with a minimum recommended composite R-value (R = thermal resistance value of the assembly) of R-20 for roofs and R-11 for walls which are exposed to solar radiation.

The insulation systems may be located inside or outside the building structure and should be selected using the following criteria as guidance:

MIL-HDBK-1011/2

MIL-HDBK-1190	<u>Facility Planning and Design Guide</u>
NAVFAC DM-1 Series	<u>Architecture</u>
NAVFAC DM-3 Series	<u>Mechanical Engineering</u>
NAVFACINST 4100.5A	<u>Design Criteria Guidance for Energy Conservation</u>
NCEL CR 83.005	<u>Handbook of Thermal Insulation Applications</u>

In hot humid climates, special attention should be given to insulation systems that protect against radiant heat gain (especially through the roof), since this is the major contributor to internal heat gains. Such systems are typically composed of one to three reflective foil liners, with airspaces between, located between or attached to the structural members. Recent studies performed at the Florida Solar Energy Center have shown that radiant barriers in both roof and wall configurations are effective at preventing heat gain if properly used. Where heat loss is a concern, they should be supplemented with standard resistive insulation such as glass fiber, mineral wool, or rigid foams.

When roof or wall insulation is not used it is the responsibility of the designer to justify the alternate proposed wall or roof system(s). In these cases, the designer should clearly show that the internal temperatures will not be adversely affected by minimizing or eliminating insulation in the roofs and/or walls.

4.5.7.1 Ventilative Considerations. Partitions and interior walls usually lower interior velocities and change airflow distributions by diverting the air from its most direct path from inlet to outlet. The closer the interior wall is to the inlet, the more abrupt the change in the airflow pattern and more of the air's velocity is dissipated. To maintain high interior velocities for natural ventilation, interior walls perpendicular to the flow should be placed close to the outlet (see Figure 39).

Placement of walls or partitions can affect airflow beneficially. Walls can be used to split airflow and improve circulation creating better overall room air distribution in rooms with poor exterior orientation (see Figure 40).

Naturally ventilated buildings should be single-loaded for easier cross ventilation. Corridors can be either on the upwind or downwind side, and may serve a dual function as shading devices if placed on the south, southeast, or southwest side of an elongated building facing one of these orientations. Odor-producing spaces such as toilets and kitchens, and noise producing spaces such as mechanical rooms, should be placed on the downwind side of the living spaces.

4.5.7.2 Thermal Considerations. Locations of rooms with respect to their thermal characteristics and requirements can reduce energy consumption. Spaces which require little heating/cooling or light (closets, storage,

MIL-HDBK-1011/2

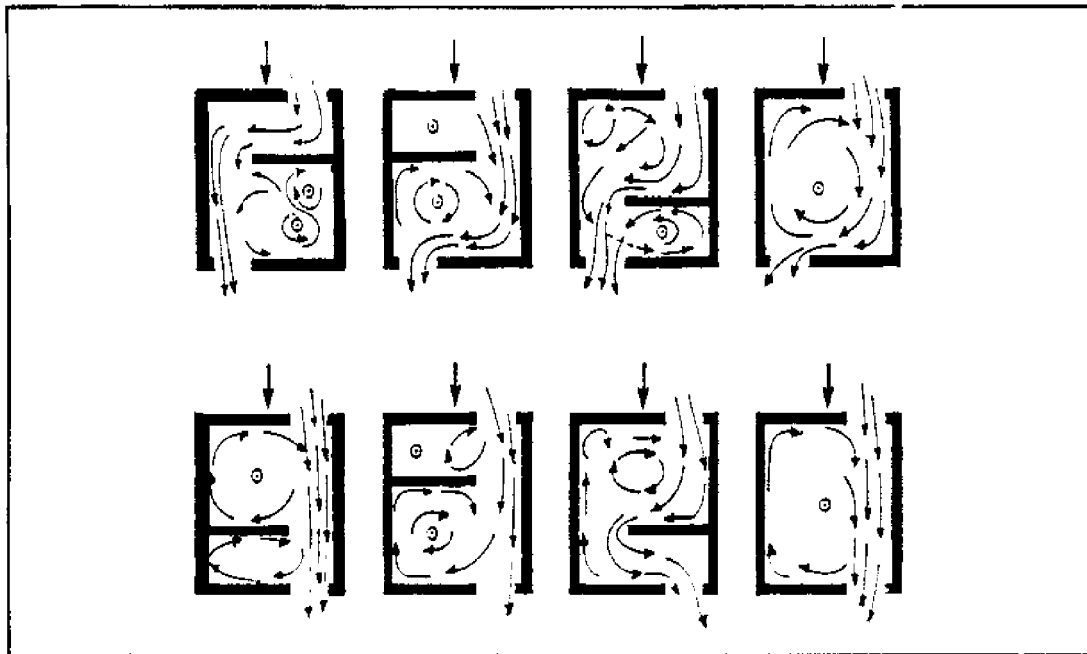

Figure 39
Effects of Interior Partition Locations on Air Flow Patterns

Figure 39
 Effects of Interior Partition Locations on Air Flow Patterns

[retrieve figure]

garages, laundry rooms, mechanical chases, stairways, etc.) can be placed on the east, west, or north exposures of the building to act as buffer spaces to minimize east/west solar gains.

Rooms with high process heat gain (such as computer rooms) or high latent heat gain (such as laundries) should be placed near the building's ventilative outlets or be separately ventilated in order to minimize heat gain to the rest of the building. They should also be separated from other ventilated spaces by insulated walls (refer to para. 3.2).

Rooms can also be zoned so that activities can take place in cooler areas during warm periods and warmer areas during cool periods of the day or season (refer to para. 3.2).

4.5.7.3 Internal Drapes and Blinds. Internal drapes and blinds are not an effective means of solar control and should not be the building's primary shading device. Although they block solar radiation, they absorb and re-radiate an appreciable amount of it within the room. This is true even for white drapes and blinds. An internal white venetian blind will reduce the daily average solar heat gain by less than 20 percent. Only exterior shading devices should be used as the primary solar control in all cases.

MIL-HDBK-1011/2

A building with exterior solar control devices may still require drapes or blinds for privacy or to control light levels or glare. Since they block ventilative airflow, their use should be carefully considered. Drapes tend to block more air movement than blinds, but under high ventilation rates blinds may fall apart or cause excessive noise. When possible, they should be solidly connected to the floor and the ceiling to prevent blowing or rattling, and should allow air movement even when fully closed. Consider the use of systems that can be controlled at different heights to allow some portions to remain open while other portions are closed.

4.5.7.4 Furniture. Large pieces of furniture can have a major effect on room airflow patterns. Items such as desks and beds can prevent air movement below 30 inches (76 cm) or divert airflow away from occupants. These effects should be considered when selecting furniture and laying out furniture plans.

4.6 Auxiliary Fan Systems. Fans are frequently used to supplement natural ventilation. Fans reduce cooling requirements by exhausting heat from the building's interior, and by increasing air movement in the living space to assist bodily cooling. Refer to para. 2.2 for a description of body and structural cooling.

4.6.1 Ceiling Fans. This type of fan is effective for bodily cooling on a room-by-room basis. Ceiling fans can provide inexpensive air mixing when wind driven ventilation is inadequate. Figure 40 shows the typical distribution of air velocity under a ceiling fan. When choosing ceiling fans consider control over speed variability, minimum and maximum speeds, noise level, power requirements and minimum floor to ceiling heights.

For naturally ventilated buildings in which high air movement (above 98 fpm or 0.5 m/sec) is required for comfort, ceiling fans are required

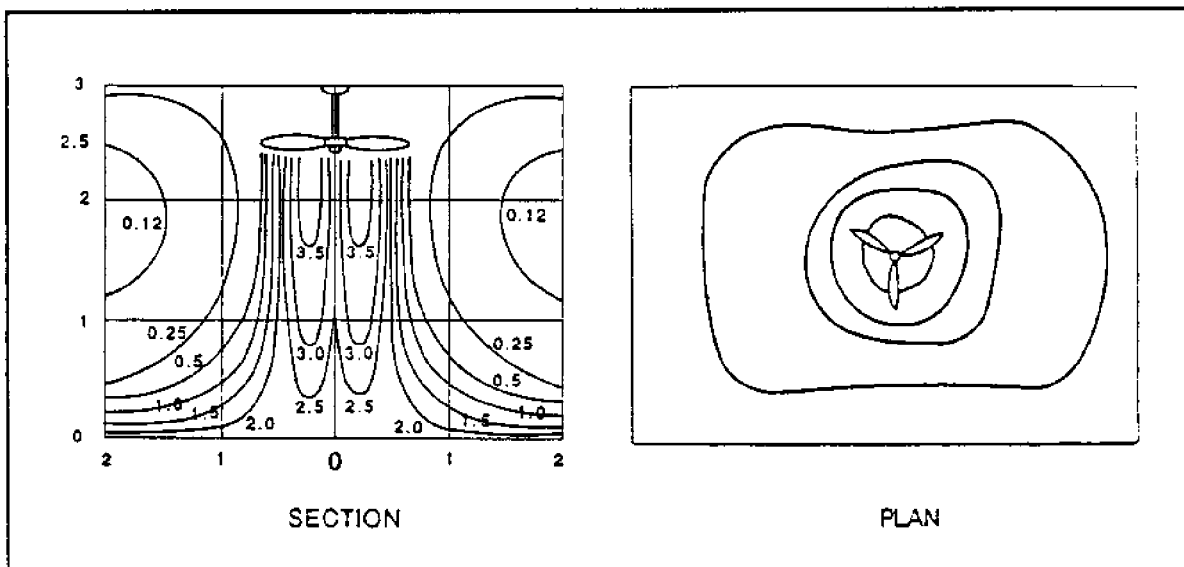

Figure 41
Air Distribution Patterns for Ceiling Fan

MIL-HDBK-1011/2

for each primary occupied space to maintain comfort during periods of low winds, extreme temperatures and/or humidities or during heavy rains when windows may be shut. Refer to para. 3.1.4e.

4.6.2 Whole-House Fans. In some cases wind-driven natural ventilation through open windows may not provide sufficient ventilation to exhaust heat from the building's interior. Constrained building orientation or dense surroundings may prevent the wind from creating pressures across the building. In such cases whole-house fans, which typically induce 30 to 60 air changes per hour, may be necessary as backup units. Whole-house fans have low initial investment costs (about \$400 to \$600 installed) and low energy use (between 300 and 500 watts, roughly one tenth the consumption of an air conditioner).

[retrieve figure]

The whole-house fan operates by pulls air in through open windows and exhausts it through the attic (see Figure 42). Openings in the floor are sometimes used to draw air from the cooler, shaded underside of an elevated building. A whole-house fan should be centrally located in the building, above a public area such as a hall or stairwell, so that it draws in air from all parts of the building.

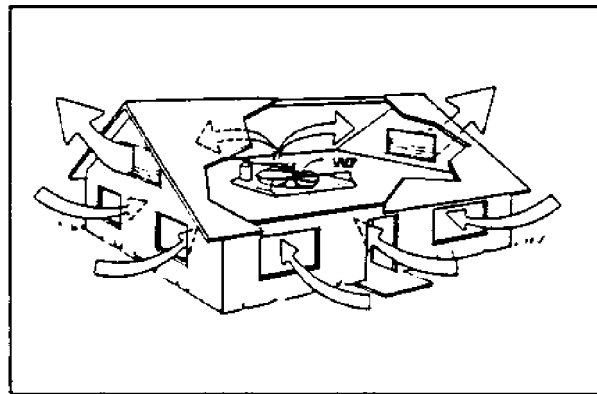

Figure 42
Air Flow from a Whole-House Fan

Whole-house fans are primarily used for cooling the building's structure, often by enhancing night ventilation. The fan is turned on when the outdoor temperatures drop in the late afternoon or early evening. In the morning, the fan should be turned off and the windows closed before the outdoor temperatures begin to rise above the interior temperature.

4.6.3 Sizing of Openings for Whole-House Fans. The total open window area should be approximately two times the open area of the fan. The total open window area should be three times the whole-house fan open area if there is insect screening at the windows. It is not necessary to open windows all the way to ventilate with a whole-house fan. They can be opened 4-6 in. (100-150 mm) and fixed in a secure position by stops or window locks.

The attic vents need to be larger than normal for effective whole-house fan ventilation. The free exhaust area should be approximately twice that of the area of the fan itself, and three times the area if screening is used. Openings should be distributed throughout the attic or placed to the lee side of the building for adequate ventilation. Refer to Appendix C, Section 4 for whole-house fan sizing procedure.

4.6.4 Fans for Body Cooling. Although whole-house fans can create some air motion, especially near windows and near the fan outlet, the interior velocities created are in general too low for body cooling. Therefore, ceiling fans or portable oscillating fans are recommended for body cooling. It is possible to use both types of fans in combination in one building.

MIL-HDBK-1011/2

PAGE 54 INTENTIONALLY LEFT BLANK

MIL-HDBK-1011/2

Section 5: OCCUPANT AND MAINTENANCE MANUALS

5.1 Purpose. In order to maintain the level of comfort for which the building was designed, user-occupants must be informed about the special nature of their environment and how to use any unusual occupant-controlled mechanisms provided in the building. Also special maintenance considerations that affect natural ventilation and comfort should be identified.

5.2 Occupant's Manual. A short, informative letter about the unique and special features of the building and their proper use should be sent to each occupant or posted prominently in each room. This letter should contain information on:

a) The natural ventilation strategy and how it works. For example, occupants should be informed that unless outside air temperatures are comfortable, windows and other openings should be closed during the day, opened at night, and ceiling fans used instead to provide air movement.

b) Proper use of blinds, insulated shades, shutters, fans and other operable devices.

c) Use of mechanical/air conditioning backup systems.

5.3 Maintenance Manual. Requirements for the maintenance of any features affecting the ventilative effectiveness of the buildings must be identified and outlined. The basic principle(s) behind the particular feature should be noted so that the maintenance personnel will understand why the specific requirements must be followed. This handbook should include information on the proper care of:

a) Building envelope--color and other surface requirements, schedules for cleaning, etc.

b) Landscaping--pruning and its effect on ventilation and shading, watering, etc.

c) Mechanical systems--any special considerations.

d) Special features or devices--insulated shades, ceiling fans, evaporative coolers, etc.

e) Areas and features which cannot be built up or obstructed without adversely affecting occupant comfort must be identified. Planners and designers of later additions or modifications must be properly informed of these areas and the possible affects of their actions.

MIL-HDBK-1011/2

PAGE 56 INTENTIONALLY LEFT BLANK

MIL-HDBK-1011/2

APPENDIX A
FUNDAMENTAL PRINCIPLES

MIL-HDBK-1011/2
APPENDIX A (continued)

PAGE 58 INTENTIONALLY LEFT BLANK

MIL-HDBK-1011/2
APPENDIX A (continued)

CONTENTS

Section	1	PEOPLE AND COMFORT	62
	1.1	Comfort Criteria	62
	1.2	The Effect of Air Movement	62
	1.3	Acceptable Comfort Zone	62
	1.3.1	Comfort, Humidity, and Condensation	62
	1.4	The Bioclimatic Chart	65
	1.5	Variations in Clothing and Activity Level	65
Section	2	CLIMATE AND MICROCLIMATE	66
	2.1	Climatic Elements Affecting Natural Cooling	66
	2.2	Extrapolating Regional Weather Data to Specific Sites	66
	2.2.1	Humidity	66
	2.2.2	Solar Radiation	66
	2.2.3	Temperature	67
	2.2.4	Wind	67
	2.2.4.1	Topography	67
	2.2.4.2	Vegetation	68
	2.2.4.3	Local Winds	70
Section	3	PREDICTING AIRFLOW AROUND NEARBY BUILDINGS AND OBSTRUCTIONS	72
	3.1	Introduction	72
	3.2	Airflow Around a Single Simple Building	72
	3.2.1	Airflow Toward and Beyond the Wake	72
	3.2.3	Airflow Pressure Zones and Wakes	72
	3.2.4	Wake Geometry	74
	3.3	Airflow Around Multiple Buildings	74
	3.3.1	Downwash at the Foot of a Tall Building	74
	3.3.2	Corner Effect	74
	3.3.3	Gap Effect	75
	3.3.4	Pressure Connection Effect	75
	3.3.5	Channel Effect	75
	3.3.6	Venturi Effect	76
	3.3.7	Pyramid Effect	77

FIGURES

Figure	A-1	Bioclimatic Chart with Example Points	63
	A-2	Velocity Profiles of Wind Near a Ridge	67
	A-3	Two Typical Windflow Patterns Near San Francisco	67
	A-4	Wind Velocity Profiles Near Trees	68
	A-5	Day Sea Breeze and Night Land Breeze	69
	A-6	Slope Winds	70
	A-7	Positive Pressure on Windward Face	71
	A-8	Pressure Zones and Wake Cavity	72
	A-9	Pressure Zones and Shapes of Wakes	72
	A-10	Downwash at the Foot of a Tall Building	73

MIL-HDBK-1011/2
APPENDIX A (continued)

A-11	Winds at Building Corners	74
A-12	Winds Through Gaps at Ground Level	74
A-13	Pressure Connection Effect	74
A-14	Channel Effect	75
A-15	Venturi Effect	75
A-16	Pyramid Effect	76

TABLES

Table	A-1	Metabolic Rates	62
	A-2	Clo Values	62

MIL-HDBK-1011/2
APPENDIX A (continued)

Section 1: PEOPLE AND COMFORT

1.1 Comfort Criteria. Thermal comfort is maintained when the body is in thermal equilibrium with its surroundings. The human body exchanges heat with the environment through convection, radiation, evaporation, and through conduction to solid objects. The primary environmental factors affecting these heat exchanges are: air temperature, surrounding surface temperatures (mean radiant temperatures or MRT), humidity, solar radiation from the sun and sky, and air motion. The primary personal factors affecting the heat exchanges are activity level (equivalent to metabolic rate and measured in mets) and clothing insulation (measured in clo). Current research does not indicate significant differences in the perception of comfort due to differences in age (of adults), nationality, or sex.

1.2 The Effect of Air Movement. Air movement influences bodily heat balance by affecting the rate of convective heat transfer between skin and air, and the rate of bodily cooling through evaporation of skin moisture.

1.3 Acceptable Comfort Zone. The acceptable comfort zone shall be as prescribed by ASHRAE Standard 55. Eighty percent or more of building occupants will find this zone thermally acceptable in still air and shade conditions. The standard is based on the concept of operative temperature, t_o , in which air temperature and radiant temperature are linked as follows:

$$\text{EQUATION: } t_o = (h+c, t_a + h+r, t_r) / (h+c + h+r) \quad (3)$$

where: $h+c$, is the heat transfer coefficient of air,
 $h+r$, is the heat transfer coefficient of mean radiant temperatures,
 t_a , is the temperature of the air, and
 t_r , is the mean radiant temperature.

Figure 4 in Section 2 gives the acceptable range of operative temperature and humidity for persons in typical summer (0.35 to 0.6 clo) and winter (0.8 to 1.2 clo) clothing at near sedentary (< 1.2 met) activity levels. See Tables A-1 and A-2 for ranges of activity levels and typical clothing.

1.3.1 Comfort, Humidity, and Condensation. It is possible to have moisture condensation in a building below the humidity maximum of 95 percent relative humidity shown in Figure A-1. ASHRAE Standard 55-1981 has a lower maximum (0.012 humidity ratio) that is based on avoiding condensation and mold growth in ducts of centrally air conditioned buildings rather than on human thermal comfort requirements. In naturally ventilated buildings, surface temperatures are closer to the ambient air temperature than in the ducts of mechanically air conditioned buildings. This reduces the potential for condensation and mold growth, allowing the higher acceptable humidity limit.

Figure A-1 also gives air velocities required to allow occupants to feel comfortable at temperature and humidity conditions above the still air comfort zone; this figure is called a "bioclimatic chart" because it plots the comfort boundaries over an extended range of environmental conditions.

MIL-HDBK-1011/2
APPENDIX A (continued)

Table A-1
Metabolic Rates

<u>Activity</u>	<u>Metabolic Rate (Met)</u>	
		1
Reclining	0.8	*
Seated quietly	1.0	*
Sedentary activity (office, dwelling, lab, school)	1.2	*
Standing, relaxed	1.2	*
Light activity, standing (shopping, lab, light industry)	1.6	*
Medium activity, standing (domestic work, machine work)	2.0	*
High activity (heavy machine work, garage work)	3.0	*
* 1 Met = 58 watts/m.2- of body surface, or 50 kcal/h * m.2- of body surface, or 18.4 Btu/h * ft.2- of body surface.		

Table A-2
Clo Values

MEN		WOMEN	
Underwear:		Underwear:	
Sleeveless	0.06	Bra and panties	0.05
T-shirt	0.09	Half slip	0.13
Briefs	0.05	Full slip	0.19
Long underwear top	0.10	Long underwear top	0.10
Long underwear bottom	0.10	Long underwear bottom	0.10
Torso:		Torso:	
Light short sleeve shirt	0.14	Light blouse	0.20
Light long sleeve shirt	0.22	Heavy blouse	0.29
Heavy short sleeve shirt	0.25	Light dress	0.22
(+5% for tie or turtleneck)			
Light vest	0.15	Light skirt	0.10
Heavy vest	0.29	Heavy skirt	0.22
Light trousers	0.26	Light slacks	0.26
Heavy trousers	0.32	Heavy slacks	0.44
Heavy sweater	0.37	Heavy sweater	0.37
Light jacket	0.22	Light Jacket	0.17
Heavy jacket	0.49	Heavy jacket	0.37
Footwear:		Footwear:	
Ankle socks	0.04	Any length stockings	0.01
Knee high socks	0.10	Pantyhose	0.01
Sandals	0.02	Sandals	0.02
Oxford shoes	0.04	Pumps	0.04
Boots	0.08	Boots	0.08

MIL-HDBK-1011/2
APPENDIX A (continued)

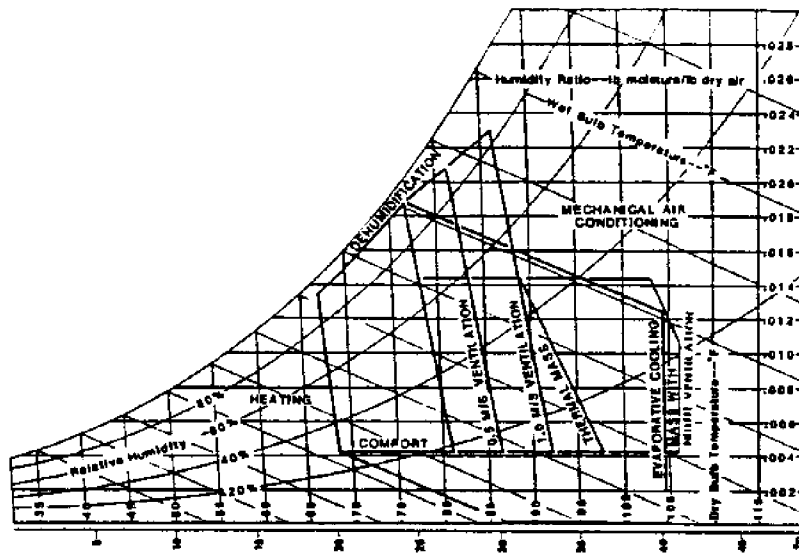

A. COMFORT ZONE WITH AIR MOVEMENT REQUIREMENTS

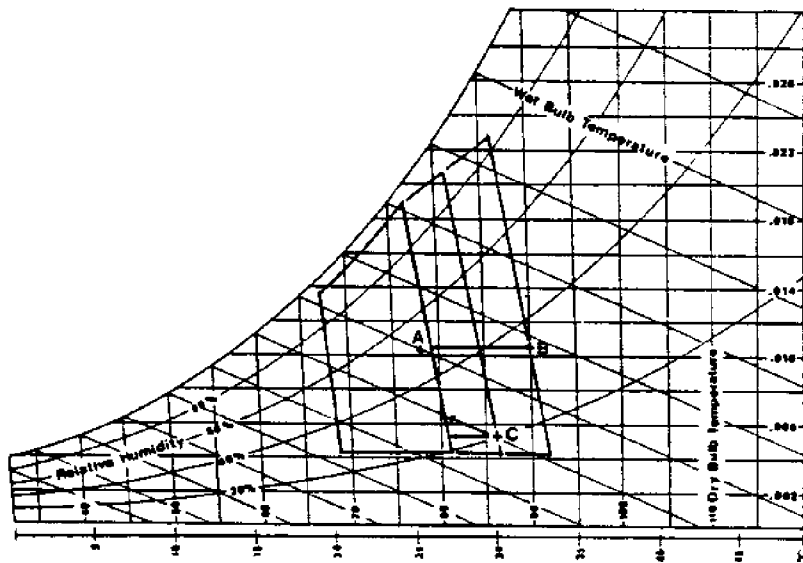

B. SAMPLE APPROACHES TO OBTAINING COMFORTABLE CONDITIONS

Figure A-1
Bioclimatic Chart with Example Points

MIL-HDBK-1011/2
APPENDIX A (continued)

1.4 The Bioclimatic Chart. If the plotted point falls within the comfort zone, conditions are comfortable in the shade and in still air (air movement less than 5.0 fpm or 0.026 m/sec). If the point falls outside the comfort zone, corrective measures are necessary to bring conditions into the comfort zone. If the point is to the left of the comfort zone, additional solar or surface radiation is needed. If the point is the right of the comfort zone, additional air movement is needed. If the point is below the comfort zone, additional moisture is needed and if above, dehumidification is needed. For the following examples, see Figure A-1.

a) Comfort Zone: Point A--78deg.F (25deg.C) and 50 percent relative humidity. No corrective measures needed; comfort in shade and still air.

b) Air Movement: Point B--90deg.F (32deg.C) and 35 percent relative humidity. Corrective measure: air movement of 197 fpm (1.0 m/sec) is required for human thermal comfort.

c) Moisture: Point C--86deg.F (30deg.C) and 20 percent relative humidity. Corrective measure: lower the temperature by evaporating water with the attendant effect of increasing the humidity. Note that comfort could also be attained by providing air movement of 98 fpm (0.5 m/sec).

1.5 Variations in Clothing and Activity Level. The comfort zone temperatures of Figure A-1 shall be decreased when the average steady state activity level of the occupants is higher than near sedentary (1.2 met). The acceptable temperature depends both on the time average activity level and on clothing (clo) insulation (refer to Table A-2). The acceptable temperature for activity levels between 1.2 and 3.0 mets can be calculated as follows.

$$\text{EQUATION:} \quad \text{Total Clo} = 0.82 \text{ (sum of individual items)} \quad (4)$$

$$\text{EQUATION:} \quad t_{\text{active}} = t_{\text{sedentary}} - 5.4 (1 + \text{clo})(\text{met} - 1.2)\text{deg.F} \quad (5)$$

or:

$$\text{EQUATION:} \quad t_{\text{active}} = t_{\text{sedentary}} - 3 (1 + \text{clo})(\text{met} - 1.2)\text{deg.C} \quad (6)$$

where: t = the operative temperature,
 clo = clothing insulation level (clo units), and
 $1 \text{ clo} = 0.155 \text{ m}^2\text{-deg.C/watt}$
 met = metabolic activity rate (met units).

For example, in a machine shop where the average activity from Table A-1 is 2 mets and the clothing is 1 clo, the upper and lower temperature boundaries of the comfort zone should be moved to the left as in Equation 7 or 8.

$$\text{EQUATION:} \quad 5.4 (1 + 1 \text{ clo})(2.0 - 1.2) = 5.4 (2)(0.8) = 8.6\text{deg.F} \quad (7)$$

$$\text{EQUATION:} \quad 3 (1 + 1 \text{ clo})(2.0 - 1.2) = 3 (2)(0.8) = 4.8\text{deg.C} \quad (8)$$

MIL-HDBK-1011/2
APPENDIX A (continued)

Section 2: CLIMATE AND MICROCLIMATE

2.1 Climatic Elements Affecting Natural Cooling. The local climate affects the building's energy efficiency, the comfort of its occupants, and its resistance to weathering. The climatic elements important to natural cooling in buildings are: temperature, wind, humidity and radiation. Records of these climatic elements exist in many forms. The Air Forces' RUSSWO (Revised Uniform Summary of Surface Weather Observations) or the Navy's SMOS (Summary of Meteorological Observations, Surface) Part C "Surface Winds" and Part E "Temperature and Humidity" summaries, available from the National Climatic Center in Asheville, North Carolina, are the most complete weather data available, generated from long-term hourly records taken from weather bureau and military weather stations.

Climatic elements must be examined in conjunction with each other. The wind is a good illustration of the need to relate climatic elements to each other. In humid climates it is a blessing and dominates the layout, orientation and shape of buildings. In arid climates it carries dust, brings little relief from heat and must be excluded during the daytime.

2.2 Extrapolating Regional Weather Data to Specific Sites. The weather at the building site may differ from that at the weather station providing the climatological data used in design. The climatic differences tend to increase with larger distances between the two locations. Because there are relatively few first-order weather stations providing the detailed climate data needed for natural ventilation design, the distance between any given building site and its closest or most appropriate weather station will tend to be large. This can introduce error in the predicted building performance.

To reduce this error, estimates can be made of the differences between the climates of the weather station and the building site, and, if they are significant, adjustments may be applied to the weather station data to account for the differences. The climatic differences are estimated from two sources of information. First, if one has access to a more local climate record of limited detail or limited period of measurement, one may compare this record with the more distant detailed record to estimate the overall differences between the sites. Second, the local terrain and ground cover may have predictable effects on the climate.

Of the important climate elements for the design of natural cooling in buildings, humidity and solar radiation data are not generally subject to extrapolation, reasons given in paras. 2.2.1 and 2.2.2.

2.2.1 Humidity. There is usually very little humidity data available from local second-order weather stations, and there are few generalizations that can be made about the amount of atmospheric moisture above a site, based on a description of the site's physical characteristics.

2.2.2 Solar Radiation. Solar radiation data are usually not available from local sources, either measured directly or extrapolated from cloud cover observation. It is possible to quantify the very local effects of site obstructions blocking solar radiation on site hour by hour. This information is important for accurate computer simulations of building performance, but is not a primary requirement for determining or evaluating natural cooling

MIL-HDBK-1011/2
APPENDIX A (continued)

strategies, where the elimination of solar gains is a precondition to the analysis. It is therefore beyond the scope of this handbook. Use Architectural Graphic Standards or the ASHRAE Handbook of Fundamentals to determine the shading from trees, buildings and building features. Check the documentation of the building loads program being considered for the computer simulation. If a loads program cannot handle external obstructions, it is probably better to pick a more comprehensive computer program than to preprocess the weather data to correct for local site shading effects.

2.2.3 Temperature. Temperature varies geographically with elevation and surface type. Urban areas may have higher temperatures than the surrounding rural terrain. Temperature data are most commonly available from second-order local weather stations. The data are usually in the form of monthly averages of daily maximum and minimum temperatures, obtained from daily readings from a max-min thermometer. Such averages may be used to adjust the bin data or hourly data from the weather station, by adding to each bin value or hourly value the difference between the monthly averages at the two locations. This technique might also be used to approximate an urban heat island of estimated magnitude. Be aware that if the daily temperature range (as described by the daily maximum minus the daily minimum) differs for the two sites, this technique will not be accurate. Such differences may occur between coastal and dry inland locations. Finally, each bin value or hourly value may be adjusted for altitude differences at the adiabatic lapse rate of 5.4deg.F per 1,000 ft elevation (1deg.C per 100 m), with temperature decreasing with elevation.

2.2.4 Wind. The most important climate data extrapolations occur with the wind. As with temperature, local records may be used to adjust the bin or hourly data. Local records of wind are however far less common than local temperature records, and are often of dubious accuracy due to poorly positioned or maintained instruments. The most likely adjustment will be due to local site influences. These could be assessed by setting up short-term monitoring on site to obtain a local record, or by estimating the wind effects of the local site based on some of the principles described below. For major projects, a meteorologist should be consulted to make such estimates.

2.2.4.1 Topography. Topography has a pronounced effect on the wind at the surface. Wind flow conforms to terrain, changing its strength, steadiness, and direction as it passes over the uneven ground. Figure A-2 shows the velocity profiles of wind approaching a hill or ridge, at the crest, and on its leeward side. A strong acceleration is seen near the surface at the top of the hill, and a flow reversal due to an eddy at low levels in its lee. In general, the wind acceleration on the windward side of hills and ridges is fairly predictable, but the extent of shelter in the lee is highly variable, depending on the roughness of the hill and the stability of the atmosphere.

Wind may also be extensively channeled by topography. Figure A-3 shows two typical wind flow patterns identified in the San Francisco Bay region. High ground is noted in gray. Local areas of wind turning in excess of 90 degrees to the gradient wind may be noted. This type of channeling occurs primarily when the atmosphere is stable, and the flows depicted extend roughly to the height of the surrounding terrain. Similar flow turning and channeling has been observed in street canyons.

MIL-HDBK-1011/2
APPENDIX A (continued)

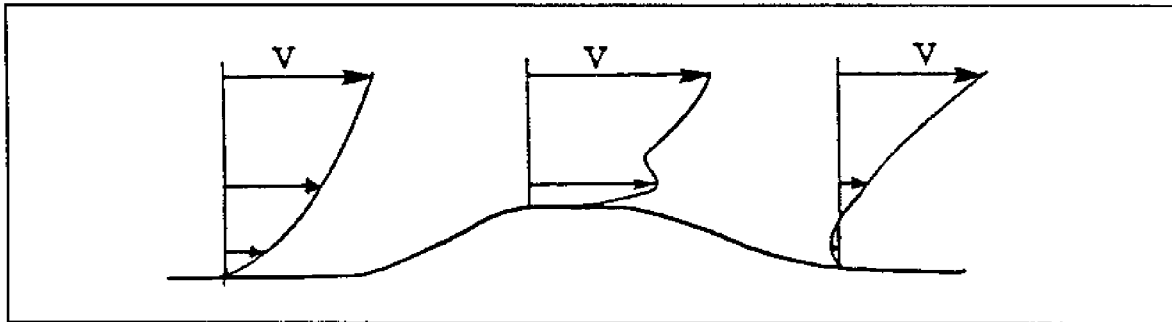

Figure A-2
Velocity Profiles of Wind Near a Ridge

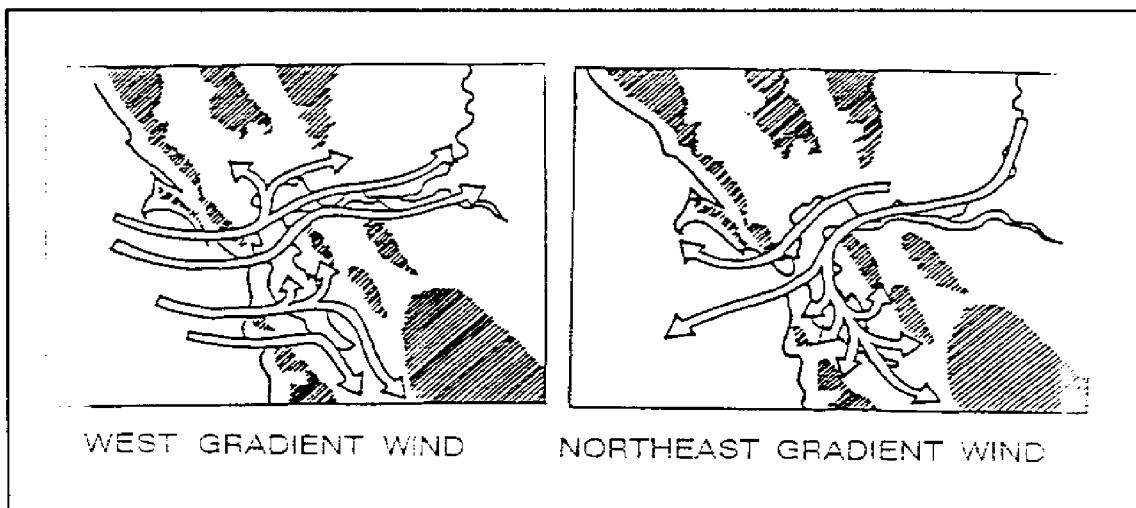

Figure A-3
Two Typical Windflow Patterns Near San Francisco

2.2.4.2 Vegetation. Tall vegetation may substantially reduce wind speed at ground level. Trees are very effective at absorbing wind energy rather than deflecting it as do solid obstructions such as terrain and buildings. Two types may be categorized: the surrounding forest and the isolated windbreak. Within a forest, the velocity is minimum near the center of mass of the foliage in the crown (approximately 0.75 times the height); in the absence of underbrush there is a velocity increase among the tree stems.

The shape of the wind profile in the forest is contingent on the type of the trees in the forest, their spacing and openings in the crown, and the distance from the edge of the stand from which ground level wind can

MIL-HDBK-1011/2
APPENDIX A (continued)

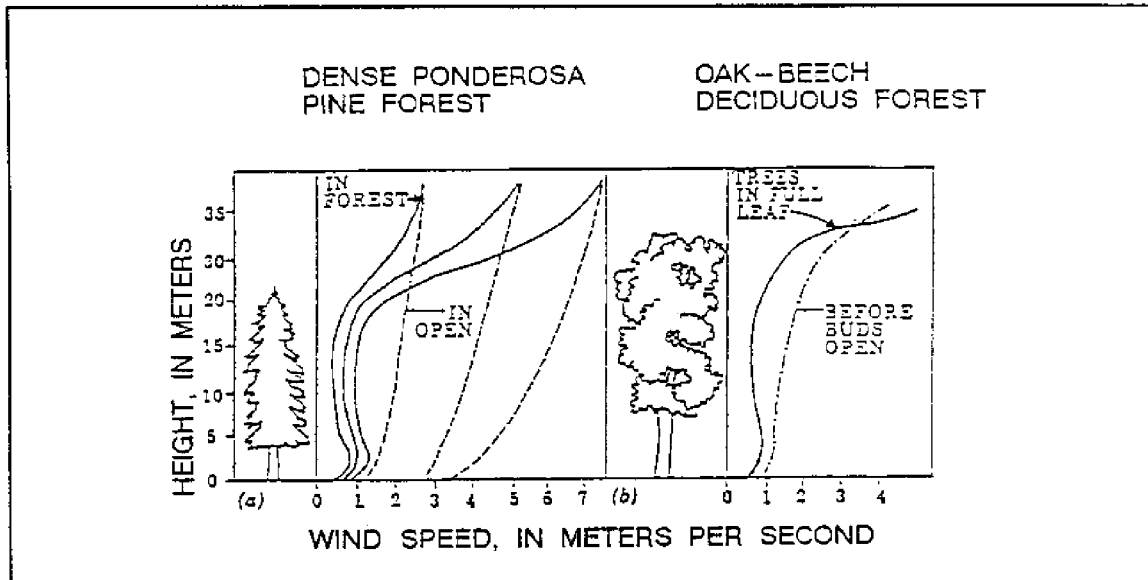

Figure A-4
Wind Velocity Profiles Near Trees

penetrate. Figure A-4a compares wind velocity profiles in a ponderosa pine stand to those in the open; Figure A-4b shows the influence of foliage from seasonal wind measurements in a deciduous oak-beech forest.

The extent of the sheltered area produced by a windbreak varies with the physical dimensions and porosity of the barrier. Porous barriers cause less turbulence and can create a greater area of total shelter than solid barriers. The more solid the barrier, the shorter the distance to the point of minimum wind velocity and the greater the reduction in velocity at that point. The velocity, however, increases more rapidly downwind of the minimum point than behind a more porous barrier. Figure 10 in Section 4 of this handbook shows a cross section of the airflow near a screen of 50 percent porosity. Figure 10 also shows the effect of varying porosity in shelter at ground level downwind.

A porosity of 40 to 50 percent has been found to provide maximum extent of sheltered area. This reduction in leeward velocity occurs without appreciable disturbance of the airflow. Windbreaks with higher porosities (greater than 50 percent) do not form a turbulent wake and the airflow pattern is dependent on the velocity of the flow. These windbreaks provide more protection from 5H to 20H with velocities reduced to 30 percent of the free stream velocity, but less protection up to 5H. Windbreaks with lower porosities (less than 35 percent) exhibit a turbulent wake that provides more protection up to 5H with velocities reduced to 10 percent of the free stream, but provides less protection from 5H to 20H with velocities up to 60 percent of the free stream. The large-scale eddies within the wake are sensed as gusts and may be disruptive to outdoor uses in the wake area.

MIL-HDBK-1011/2
APPENDIX A (continued)

Additional belts downwind of each other have been found to have slightly decreasing effect, presumably due to the increased turbulence in the lee of the first belts. Similarly, the sheltered zone leeward of a wide shelterbelt or forest is less extensive than that behind a single permeable windbreak.

2.2.4.3 Local Winds. In addition to the synoptic winds caused by large scale weather patterns, there are predictable "local winds" induced by features of the terrain. The differential heating of land and water cause sea and land breezes in many coastal locations. The sea breeze tends to move inshore around midday as the land warms and the pressure differences increase.

Figure A-5 shows the pressure distribution and flow causing the daytime sea breeze and night land breeze. Frictional resistance of the surface often causes the incoming air to dam up and form a small scale front which progresses inland throughout the afternoon. In locations where there is not a great temperature difference between land and water, the sea breeze layer will be shallow and the velocities weak. Tall buildings along a waterfront can completely block such a breeze. On the other hand, the strong San Francisco sea breeze is over 660 ft (200 m) deep, predictably exceeds 22 mph (10 m/sec) in the city throughout summer afternoons, and extends 37 miles (60 km) inland. At night the flow is reversed, but velocities seldom exceed 4.4 mph (2 m/sec).

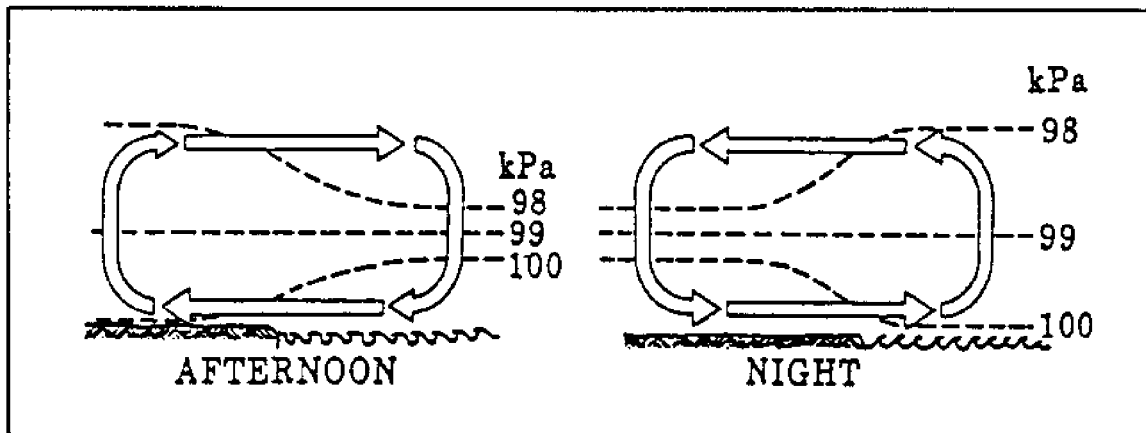

Figure A-5
Day Sea Breeze and Night Land Breeze

Slope winds (Figure A-6) are caused by the radiant heating and cooling of inclined surfaces, which cause temperature differences between the air over the inclined surface and air at the same level some distance from the slope. This causes heated air to rise along hillsides in daytime and cool air to descend ("drain") down slopes at night. Measurements on slopes surrounding the Inn Valley, Austria, found upward velocities parallel to the slope between 4.4 and 8.8 mph (2 and 4 m/sec) in the daytime, and somewhat lower downward velocities at night. The vertical extent of the wind layer was 330 to 660 ft (100 to 200 m).

MIL-HDBK-1011/2
APPENDIX A (continued)

Figure A-6
Slope Winds

When slopes are arranged in a valley system, a combination of slope winds and temperature differences from valley to plain cause valley winds. These are generally stronger than slope winds, with velocities up to 11 mph (5 m/sec). Generally, the strongest winds are found in U-shaped valleys that have high ridges lining them and which open onto a broad plain with a considerable temperature difference between the plain and the head of the valley. Valleys oriented north or south have the strongest daytime breezes due to increased exposure to the sun.

MIL-HDBK-1011/2
APPENDIX A (continued)

Section 3: PREDICTING AIRFLOW AROUND NEARBY BUILDINGS AND OBSTRUCTIONS

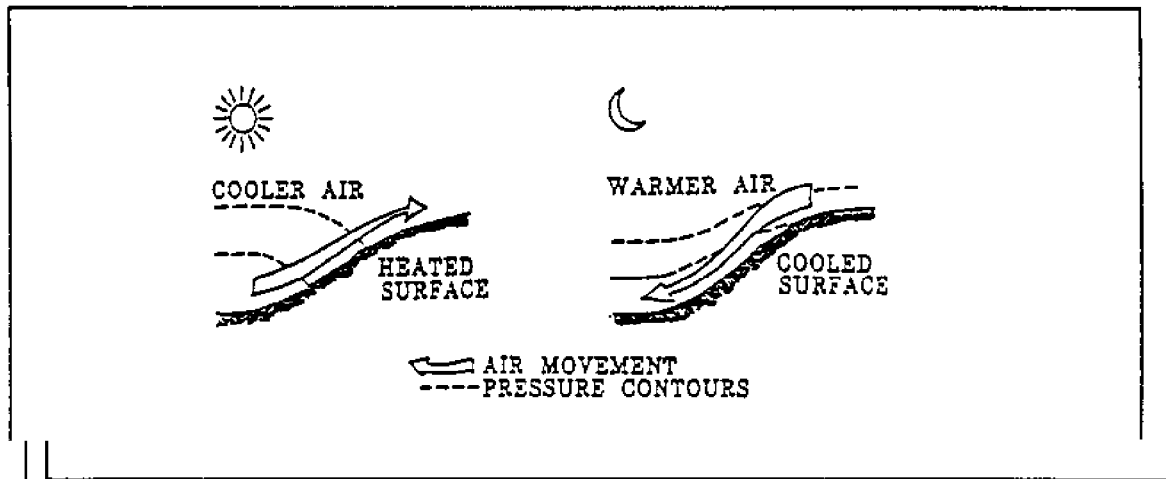
3.1 Introduction. The flow of air around buildings is complex and highly dependent on wind direction and building geometry. Architectural features such as eaves, canopies, parapets, wingwalls, and neighboring buildings and landscaping may change the flow pattern around a building significantly.

[retrieve figure]

3.2 Airflow Around a Single Simple Building. When moving air encounters an obstruction such as a building, a portion of the air movement is stopped or slowed (see Figure A-7). The deceleration converts the kinetic energy of the flow to potential energy in the form of positive pressure. If the obstruction is very streamlined (such as the wing of an airplane) the region over which this positive pressure exists is very small. On the other hand, if the obstruction is large and unstreamlined, such as the face of a building the region of positive pressure is roughly as large as the face of the building.

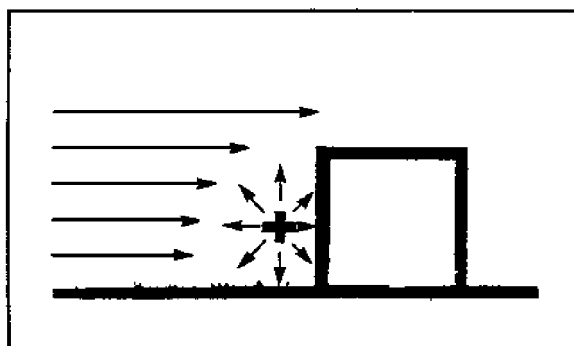

Figure A-7
Positive Pressure on Windward Face

As the air is squeezed around, above, or (if possible) below the building, the velocity accelerates and the potential energy of the positive pressure build-up is converted back into kinetic energy. When the velocity exceeds that of the approach flow, the potential energy will be lower than that of the ambient flow resulting in negative pressures or suction.

3.2.1 Airflow Toward and Beyond the Wake. As the wind approaches a sharp corner of the building, it tries to follow the geometry around the corner, but cannot due to the momentum of the flow. The wind separates from the building defining an upstream limit of the wake (see Figure A-8). Within the wake, the pressure is negative and there is relatively little air movement. At the boundary between the wake and the free stream there is substantial turbulence. Momentum transfer across the wake boundary tends to blur the position of the boundary. The free-stream airflow curves in toward the wake from all sides until it rejoins the ground or the opposite streamline downstream of the obstacle. The point at which the free-stream airflows rejoin defines the end of the wake cavity (see Figure A-8).

3.2.3 Airflow Pressure Zones and Wakes. In order for the free-stream airflows to be drawn back together to rejoin downstream of the obstacle, the pressures must be negative within the entire wake. The greater the suction, the faster the free-stream airflows are drawn together. Diagrammatically, the highest suction occurs where the radius of curvature of the wake boundary is smallest. At the end of the wake, where the wake suction approaches zero (where the wake pressure approaches the ambient pressure) the radius of curvature of the wake cavity approaches infinity. Since flows within the wake are small, structures placed and fully engulfed in the wake will not significantly alter the shape of the wake (see Figure A-9).

MIL-HDBK-1011/2
APPENDIX A (continued)

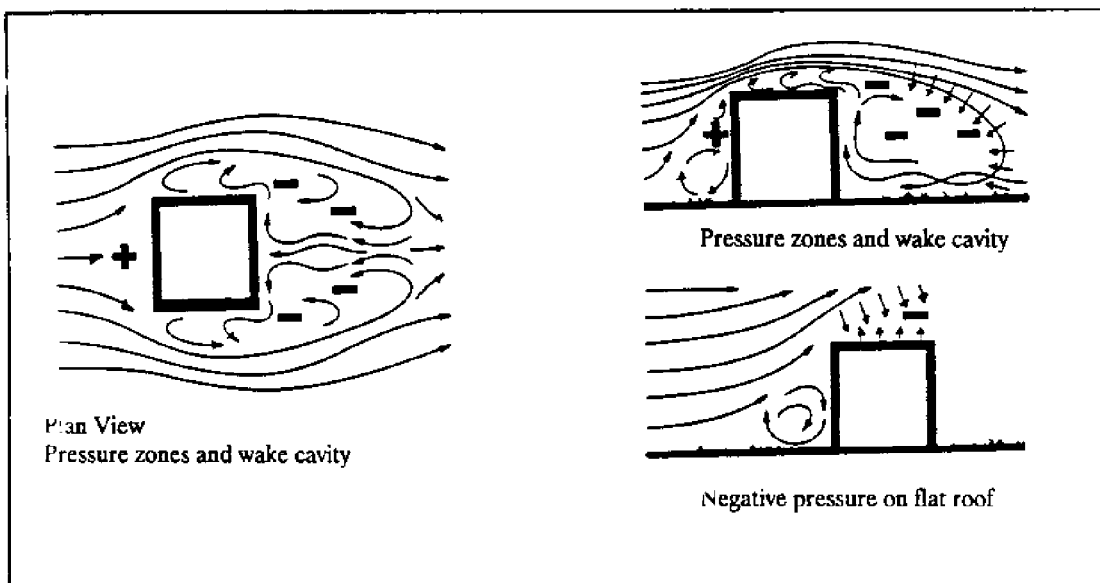

Figure A-8
Pressure Zones and Wake Cavity

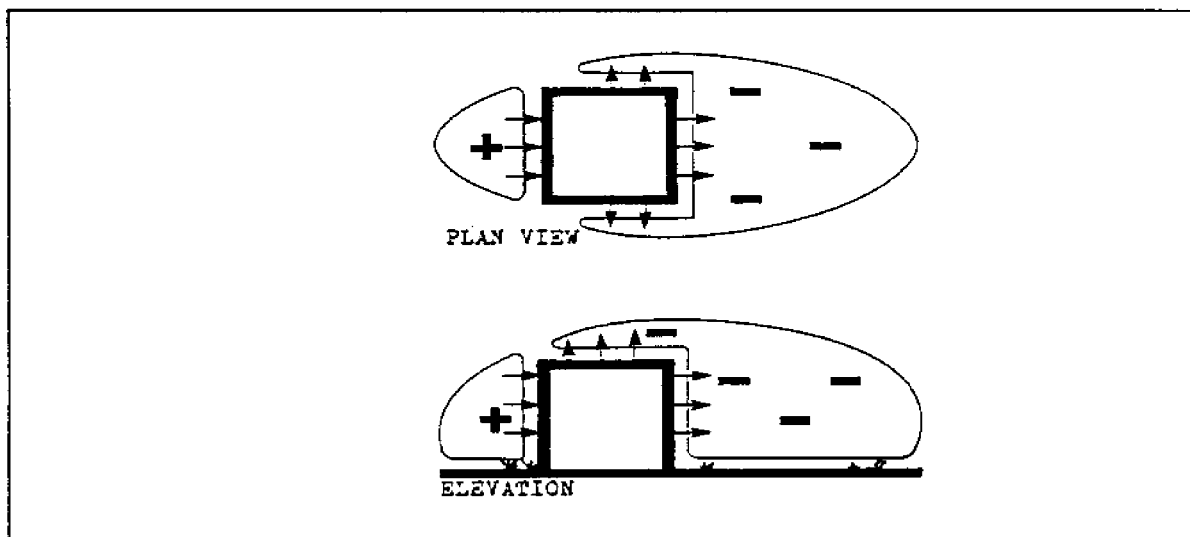

Figure A-9
Pressure Zones and Shapes of Wakes

MIL-HDBK-1011/2
APPENDIX A (continued)

3.2.4 Wake Geometry. The geometry of the wake is important because it defines the limits of significant air movement. Outside the wake, the air movement is similar to the free-stream, but the area within the wake may be considered as a cavity of relatively still air, where the pressure differences needed for building ventilation are unlikely to occur.

3.3 Airflow Around Multiple Buildings. Airflow around groups of buildings or other obstructions is very complex. The following are a few of the general airflow patterns that are commonly found to produce strong winds. These patterns may be used to benefit the ventilation of buildings in their path, but the designer should be aware that they might also adversely affect the comfort of pedestrians outside the buildings, or in semi-enclosed lobbies, corridors, or balconies.

3.3.1 Downwash at the Foot of a Tall Building. Some of the strongest winds around buildings are found at the windward side and edges of tall buildings protruding above the surrounding general level of development. This effect occurs because winds aloft are stronger than at ground level, causing higher pressures at the top of the building's windward face than at its base. This pressure difference creates a strong downward flow on the windward face (see Figure A-10).

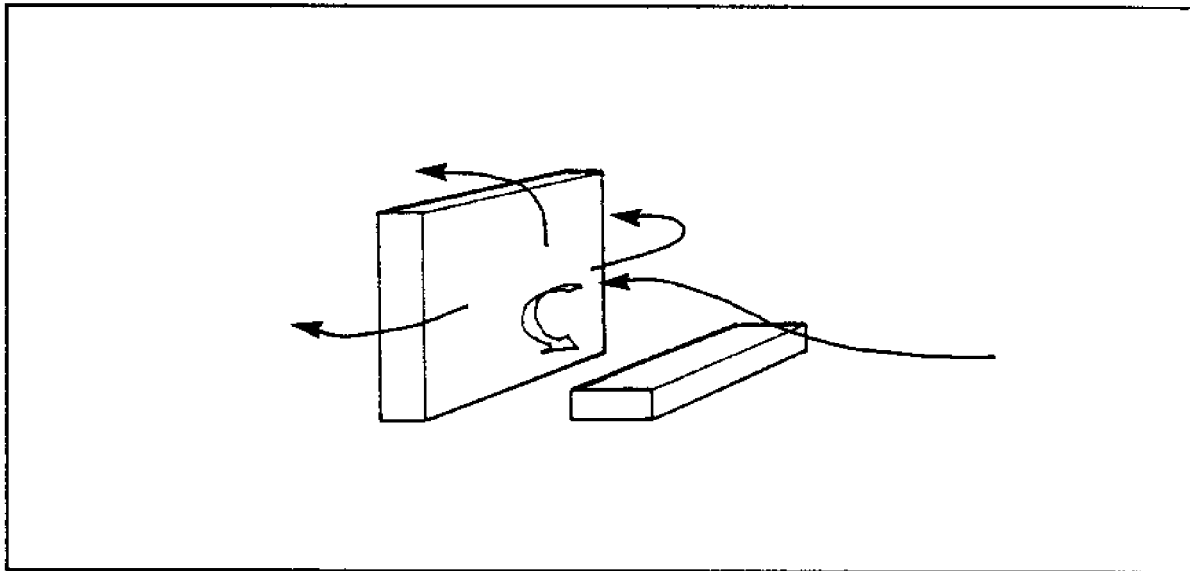

Figure A-10
Downwash at the Foot of a Tall Building

3.3.2 Corner Effect. Strong winds occur at building corners as the airflows from the high pressure zone on a building's windward side to the low pressure zone on the leeward side (see Figure A-11). Accelerated wind is generally restricted to an area with radius no longer than the building's width. The taller and wider the building, the more intense the effect. If two towers of 30 stories or more are placed less than two building widths apart, an acceleration will fill the entire space between them.

MIL-HDBK-1011/2
APPENDIX A (continued)

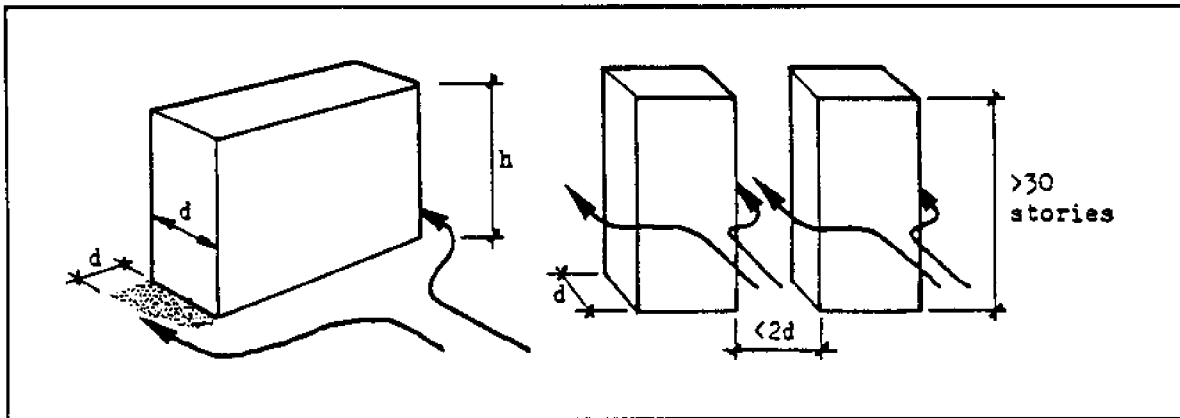

Figure A-11
Winds at Building Corners

3.3.3 Gap Effect. When a building of five stories or more is elevated on columns or has an open passageway through it, air forced through the opening(s) creates a channel of intensified wind in the opening and on its downwind side (see Figure A-12).

3.3.4 Pressure Connection Effect. Pressure connection effects develop as the wind approaches parallel rows of offset buildings, creating suction between them that draw in downdrafts from exposed windward faces and create transverse flows along the ground into the wake regions (see Figure A-13). The intensity of the effect varies with building height, with taller buildings producing more intense effects. The effects intensify further if the crossflow channel is narrow and regular.

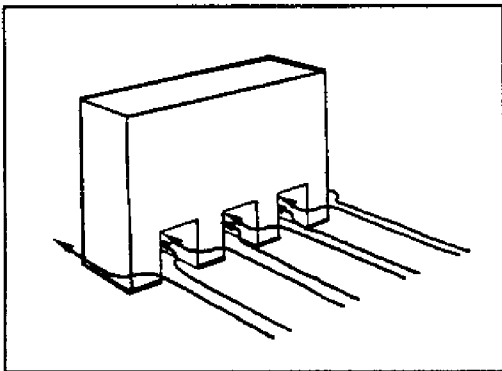

Figure A-12
Winds Through Gaps at Ground Level

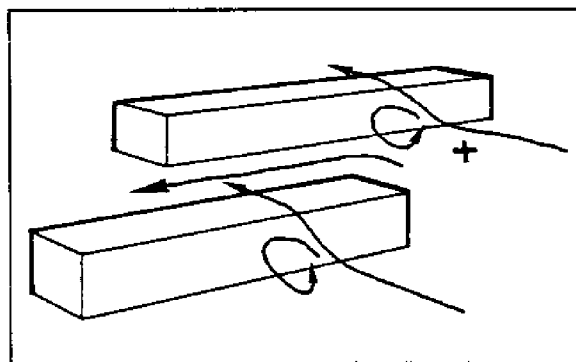

Figure A-13
Pressure Connection Effect

3.3.5 Channel Effect. A street or other open space lined with tightly grouped sets of buildings can tend to channel the wind if the space is long and narrow (less than three heights) in relation to the heights of the building which bound it (see Figure A-14).

MIL-HDBK-1011/2
APPENDIX A (continued)

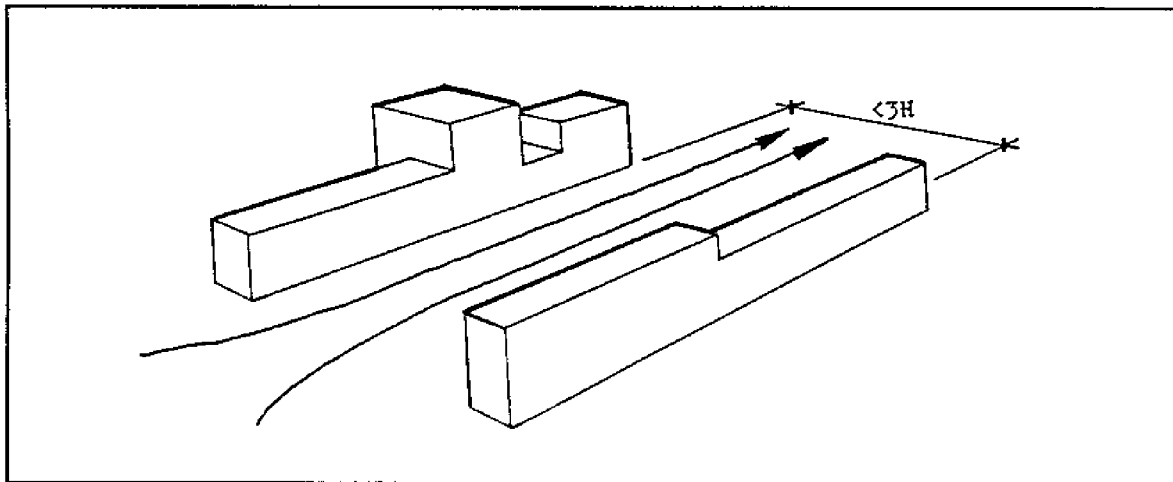

Figure A-14
Channel Effect

3.3.6 Venturi Effect. The venturi effect (see Figure A-15) occurs when two large buildings are placed at an angle to each other creating a funnel with a narrow opening that is no more than two or three times the building height. Winds channeling through the opening are accelerated to high speeds. This effect occurs only when the buildings are at least five stories high, have a combined length of 300 ft (100 m), and when the areas in front of and behind the venturi are relatively open.

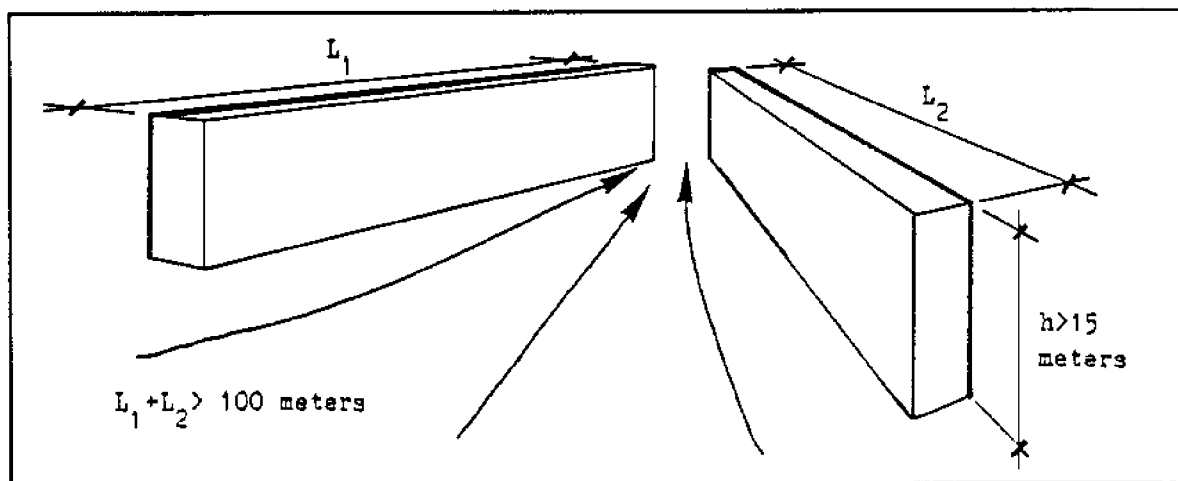

Figure A-15
Venturi Effect

MIL-HDBK-1011/2
APPENDIX A (continued)

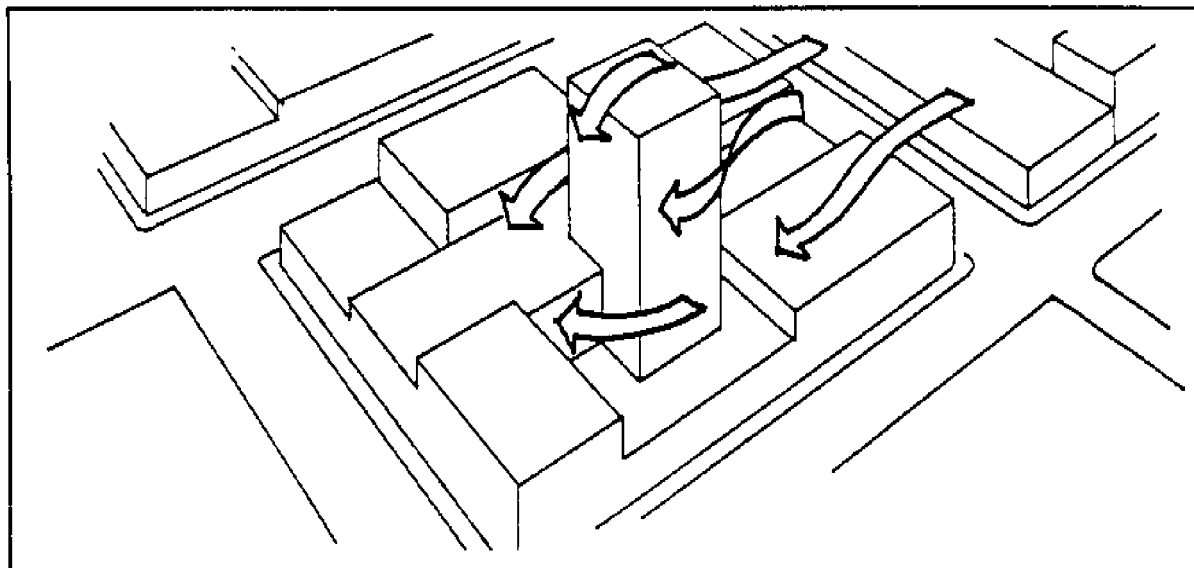

Figure A-16
Pyramid Effect

3.3.7 Pyramid Effect. Pyramidal structures offer little resistance to the wind, and generally seem to disperse the wind energy in all directions. One application of the pyramid principle is the use of tiered configurations in the design of tall buildings as a way of reducing downflow, wake and corner effects (see Figure A-16).

MIL-HDBK-1011/2

APPENDIX B
CLIMATE ANALYSIS METHOD

MIL-HDBK-1011/2
APPENDIX B (continued)

PAGE 78 INTENTIONALLY LEFT BLANK

MIL-HDBK-1011/2
APPENDIX B (continued)

CONTENTS

STEP	1	DETERMINING POTENTIAL FOR NATURAL COOLING	81
	1.1	Building Bioclimatic Chart Transferred Onto Four Overlays	81
	1.1.1	The Natural Ventilation Boundary	81
	1.1.2	Thermal Mass and Thermal Mass with Nocturnal Ventilation Boundaries	82
	1.1.3	Evaporative Cooling Boundary	82
	1.1.4	Climate Data from the National Climatic Data Center (NCDC)	82
STEP	2	DETERMINING THE APPROPRIATE COOLING STRATEGY	88
	2.1	Annual Summary--Cooling	89
	2.2	Monthly Summaries--Cooling	89
STEP	3	DETERMINING NEED FOR MECHANICAL AIR CONDITIONING	89
	3.1	Annual Summary--Air Conditioning	89
	3.2	Monthly Summaries--Air Conditioning	89
STEP	4	DETERMINING NEED FOR AN INFILTRATION-RESISTANT ENVELOPE.	89
	4.1	Annual Summary--Infiltration	89
	4.2	Monthly Summaries--Infiltration	90
STEP	5	DETERMINING NEED FOR HEATING EQUIPMENT	91
	5.1	Annual Summary--Heating	91
	5.2	Monthly Summaries--Heating	91
	5.3	Using Thermal Mass for Heating	92
STEP	6	DETERMINING THE MONTHLY FEASIBILITY OF A COOLING STRATEGY	92
	6.1	Feasibility of Natural Cooling	92
STEP	7	DETERMINING NEED FOR CEILING OR WHOLE-HOUSE FANS	92
	7.1	Procedure	92

FIGURES

Figure	B-1	Overlay 1--Ventilation	83
	B-2	Overlay 2--Thermal Mass and Nocturnal Ventilation	84
	B-3	Overlay 3--Evaporative Cooling	85
	B-4	Overlay 4--Determining the Air Conditioning Requirements	86
	B-5	Bioclimatic Chart	87
	B-6	Building Bioclimatic Chart--Relationship of Comfort Zone Between the Bioclimatic Chart and the RUSSWO/SMOS Psychrometric Summaries	87
	B-7	Determining the Cooling Strategy	88
	B-8	Determining Requirement for Open or Infiltration-Resistant Envelope	90
	B-9	Determining Heating Requirement	91
	B-10	Preliminary Climatic Analysis	94
	B-11	Climatic Analysis Summary Worksheet	99

MIL-HDBK-1011/2
APPENDIX B (continued)

PAGE 80 INTENTIONALLY LEFT BLANK

MIL-HDBK-1011/2
APPENDIX B (continued)

CLIMATE ANALYSIS

This appendix presents a method for determining the most suitable natural cooling strategy for a particular site. The method also determines the need for an open or an infiltration-resistant envelope, and whether a backup mechanical system is required.

STEP 1: DETERMINING POTENTIAL FOR NATURAL COOLING

1.1 Building Bioclimatic Chart Transferred Onto Four Overlays. The overlays (Figures B-1, B-2, B-3, and B-4) plot the range of temperatures and humidities for which the natural cooling strategies should be used in building design. They must be copied onto clear acetate by the user and carefully checked for exact size reproduction prior to use as described below.

Several strategies allow design of building envelopes for climate control. The appropriateness of a building's climate control strategy under any set of ambient temperature and humidity conditions is determined by an analysis of weather data and the requirements for human comfort, as given on the bioclimatic chart (Figure B-5). Plotting the climatic limits for each climate control strategy onto the bioclimatic chart produces a new diagram, the Building Bioclimatic Chart (Figure B-6). The Building Bioclimatic Chart indicates that whenever ambient outdoor temperature and humidity conditions fall within the designated limits of a control strategy, then the interior of a building designed to effectively execute that strategy will remain comfortable. The boundaries indicated on Figure B-6 are appropriate for residences and other buildings with small internal gains. For buildings with large internal gains, such as offices and some factories, the boundaries need to be shifted to the left. Different strategies may be used alone or in conjunction with air conditioning and conventional heating. They are:

- a) solar heating,
- b) solar gain controls,
- c) ventilation, shown at 100 and 200 fpm (0.5 and 1.0 m/sec),
- d) thermal mass (low levels of ventilation),
- e) thermal mass with nocturnal ventilation (low ventilation in the daytime and high ventilation at night), and
- f) evaporative cooling.

1.1.1 The Natural Ventilation Boundary. The natural ventilation boundary (Figure B-1) is based on the assumption that indoor air temperature and water vapor pressure are identical indoors and out, and that the mean radiant temperature of the building interior is approximately the same as that of the air. Both assumptions are sufficiently valid if the interior is well ventilated, the building envelope is well insulated and well shaded, and the exterior is light colored to restrict solar heat gain.

MIL-HDBK-1011/2
APPENDIX B (continued)

1.1.2 Thermal Mass and Thermal Mass with Nocturnal Ventilation Boundaries. The thermal mass boundaries (Figure B-2) are based on an upper comfort limit to vapor pressure and on the average outdoor daily temperature swing.

1.1.3 Evaporative Cooling Boundary. The evaporative cooling boundary (see Figure B-3) refers only to direct evaporative cooling. The boundary is based on the maximum wet bulb temperature acceptable for comfort and the cooling capacity of air.

1.1.4 Climate Data from the National Climatic Data Center (NCDC). Obtain climate data (RUSSWO or SMOS, Part E) from National Oceanography Command Detachment (NOCD), Federal Building, Asheville, North Carolina 28801-2696, telephone (704) 252-7865 or the NCDC at (704) 259-0682 for the weather station most similar to the building site. This is usually the closest station, but in pronounced terrain there may be large changes over a small distance. See Appendix A, Section 2, for a description of climate data extrapolation. RUSSWO or SMOS, Part E should include:

- a) Psychrometric summary--annual and monthly, and
- b) Means and standard deviations of dry-bulb temperature--annual.

If both RUSSWO and SMOS summaries exist, choose the one with the longest period of record. Request full size (not reduced) copies.

MIL-HDBK-1011/2
APPENDIX B (continued)

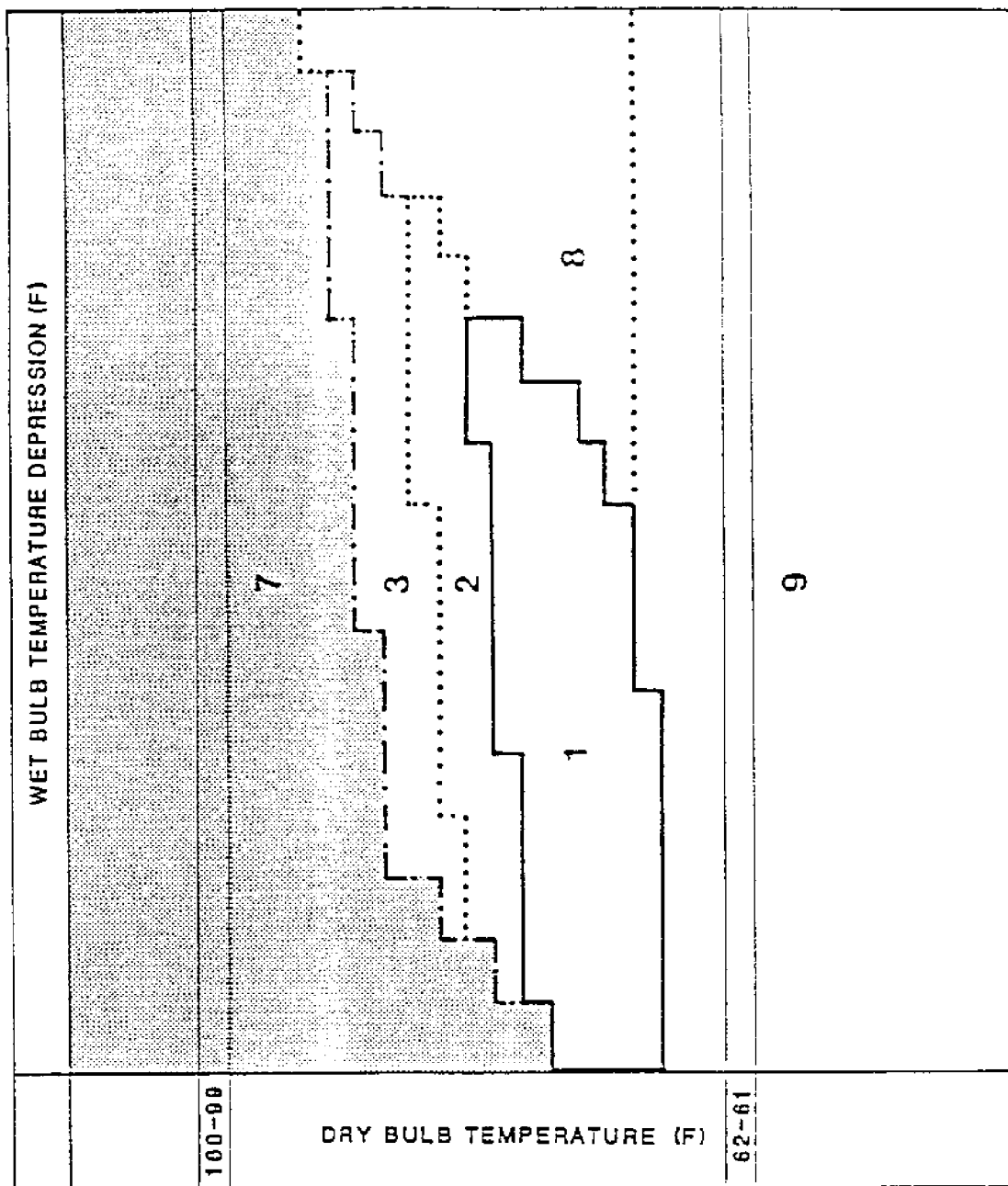

ZONES

- 1- COMFORT ZONE
- 2- 0.5 M/S VENTILATION
- 2&3- HIGH THERMAL MASS
- 4&5- MASS & NOCTURNAL VENTILATION

- 6- EVAPORATIVE COOLING
- 7- AIR CONDITIONING & DEHUMIDIFICATION
- 8- HUMIDIFICATION
- 9- HEATING

Figure B-1
Overlay 1--Ventilation

MIL-HDBK-1011/2
APPENDIX B (continued)

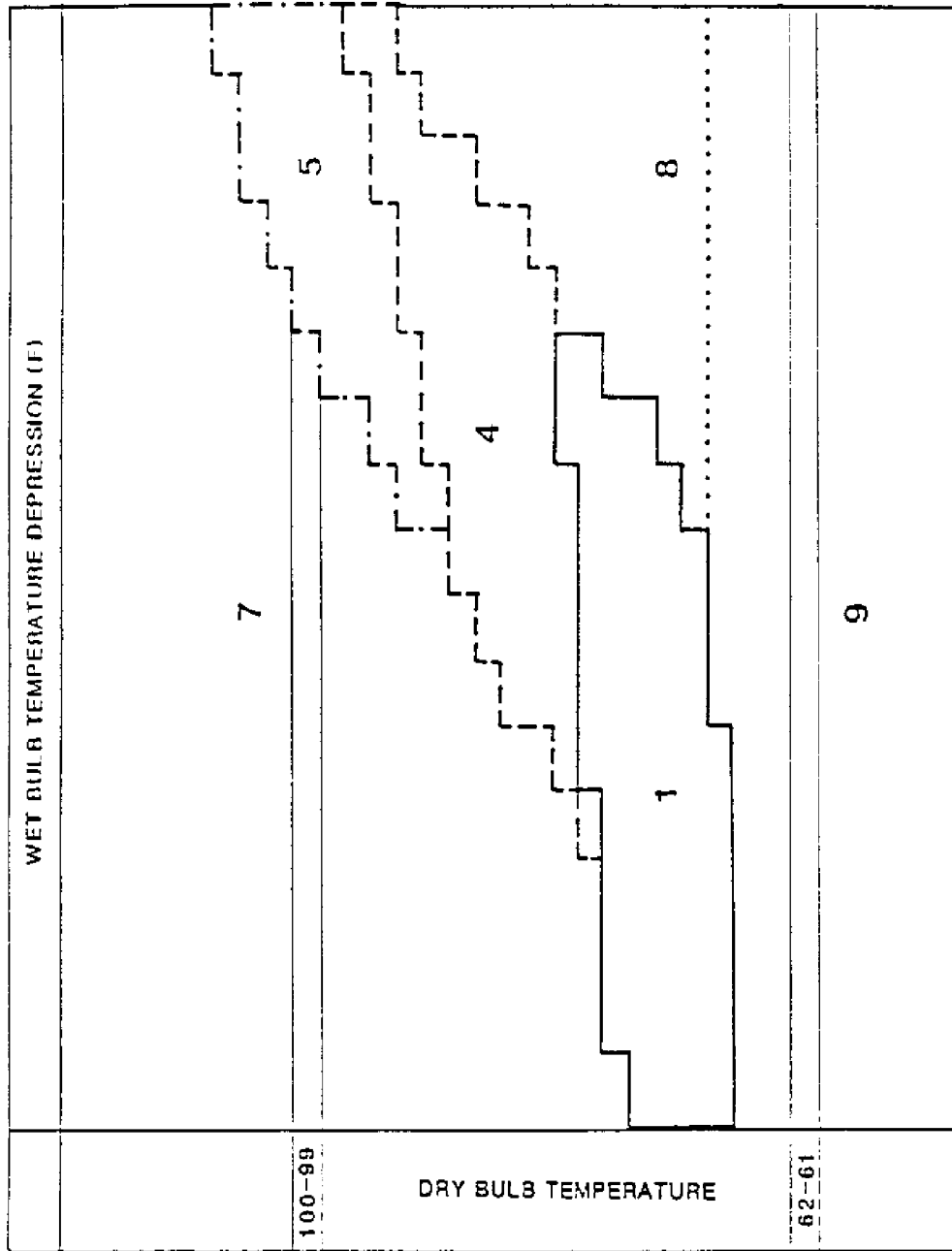

- | | | |
|-------|-----------------------------------|--|
| ZONES | 1- COMFORT ZONE | 6- EVAPORATIVE COOLING |
| | 2- 0.5 M/S VENTILATION | 7- AIR CONDITIONING & DEHUMIDIFICATION |
| | 2&3- HIGH THERMAL MASS | 8- HUMIDIFICATION |
| | 4&5- MASS & NOCTURNAL VENTILATION | 9- HEATING |

Figure B-2
Overlay 2--Thermal Mass and Nocturnal Ventilation

MIL-HDBK-1011/2
APPENDIX B (continued)

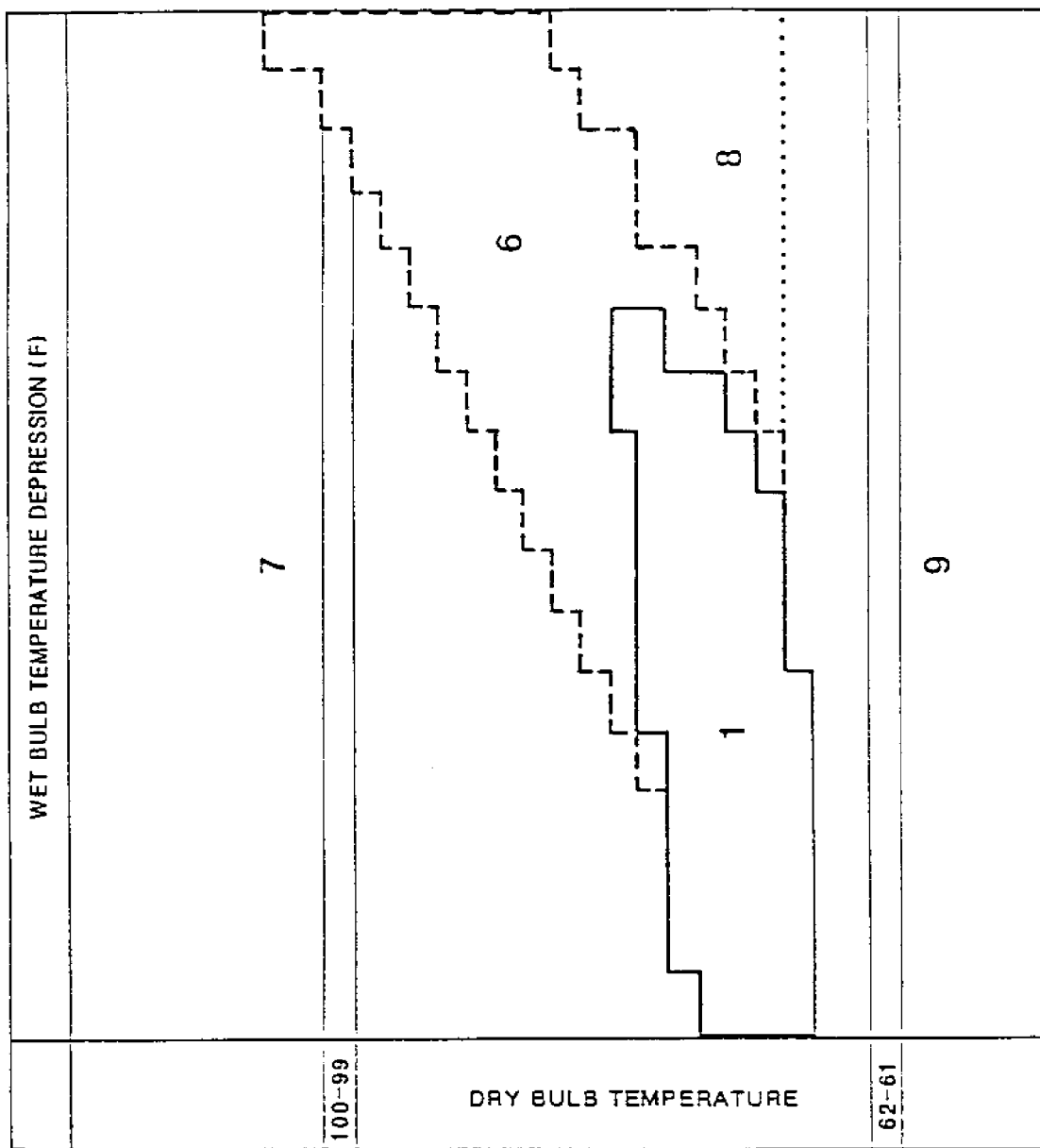

ZONES

- | | |
|------------------------------------|---|
| 1 - COMFORT ZONE | 6 - EVAPORATIVE COOLING |
| 2 - 0.5 M/S VENTILATION | 7 - AIR CONDITIONING & DEHUMIDIFICATION |
| 2&3 - HIGH THERMAL MASS | 8 - HUMIDIFICATION |
| 4&5 - MASS & NOCTURNAL VENTILATION | 9 - HEATING |

Figure B-3
Overlay 3--Evaporative Cooling

MIL-HDBK-1011/2
APPENDIX B (continued)

MIL-HDBK-1011/2
APPENDIX B (continued)

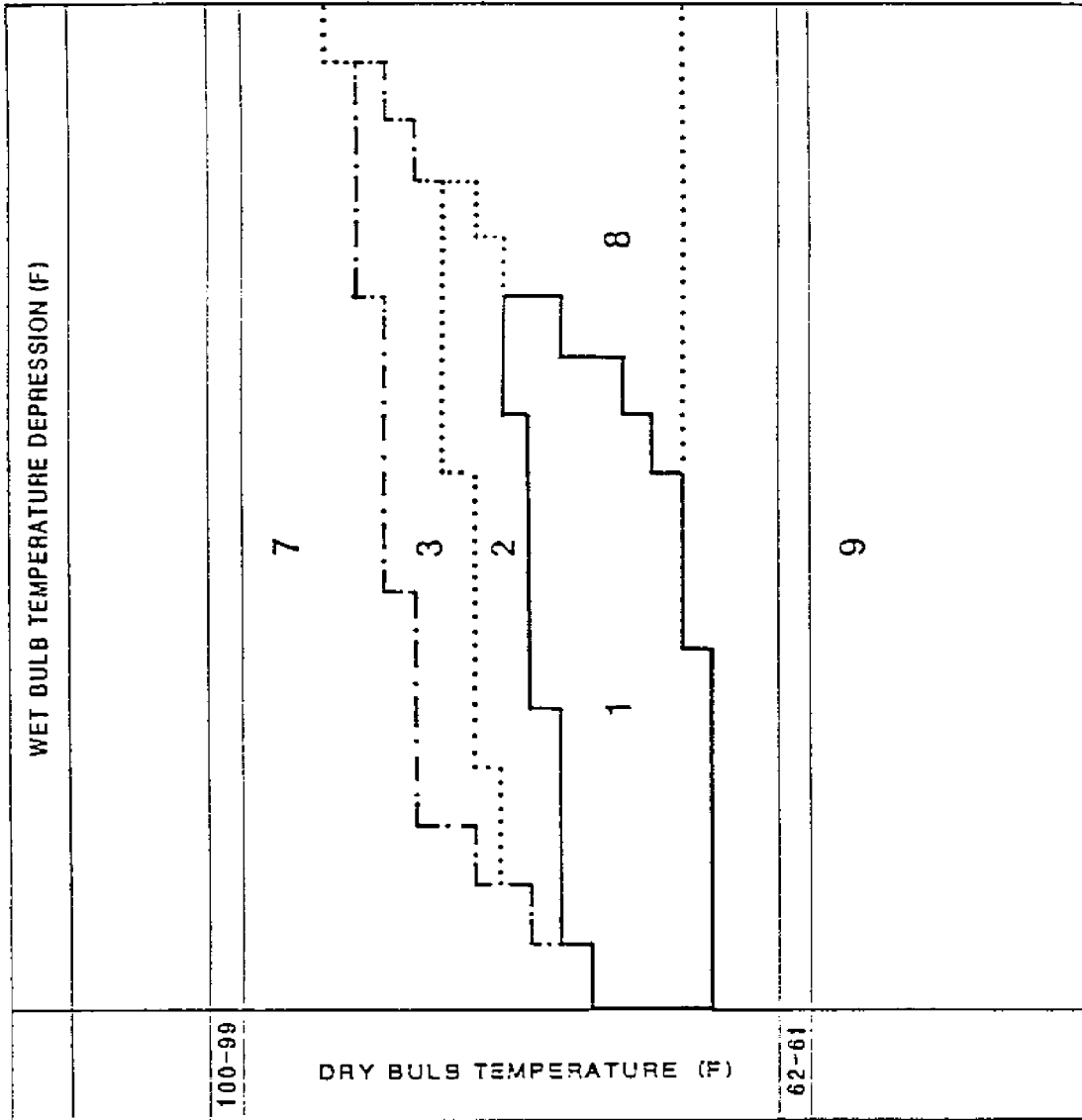

- | | | |
|--------------|-----------------------------------|--|
| ZONES | 1- COMFORT ZONE | 6- EVAPORATIVE COOLING |
| | 2- 0.5 M/S VENTILATION | 7- AIR CONDITIONING & DEHUMIDIFICATION |
| | 2&3- HIGH THERMAL MASS | 8- HUMIDIFICATION |
| | 4&5- MASS & NOCTURNAL VENTILATION | 9- HEATING |

Figure B-4
Overlay 4--Determining the Air Conditioning Requirements

MIL-HDBK-1011/2
APPENDIX B (continued)

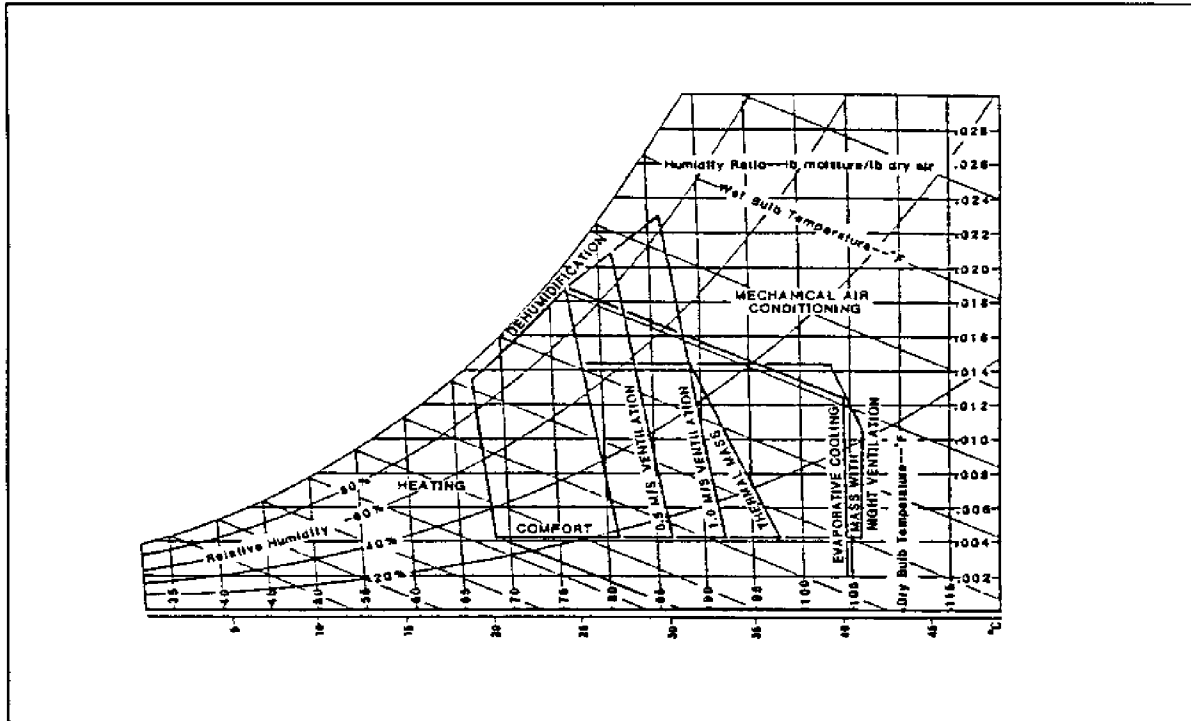

Figure B-5
Bioclimatic Chart

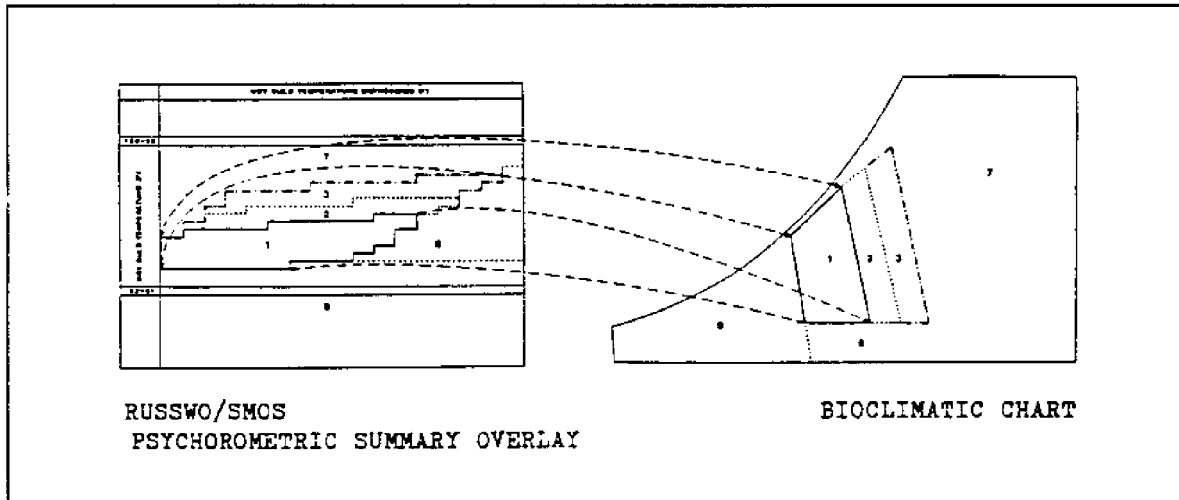

Figure B-6
Building Bioclimatic Chart--Relationship of Comfort Zone Between the
Bioclimatic Chart and the RUSSWO/SMOS Psychrometric Summaries

MIL-HDBK-1011/2
APPENDIX B (continued)

STEP 2: DETERMINING THE APPROPRIATE COOLING STRATEGY

Inspect the frequency of hours within the natural cooling strategy boundaries on the overlay to determine the percentage of time that the natural cooling strategy will apply. This step may be used to determine the most appropriate cooling strategy(s) for the climate or to determine if a zoned building is appropriate (see Figure B-7).

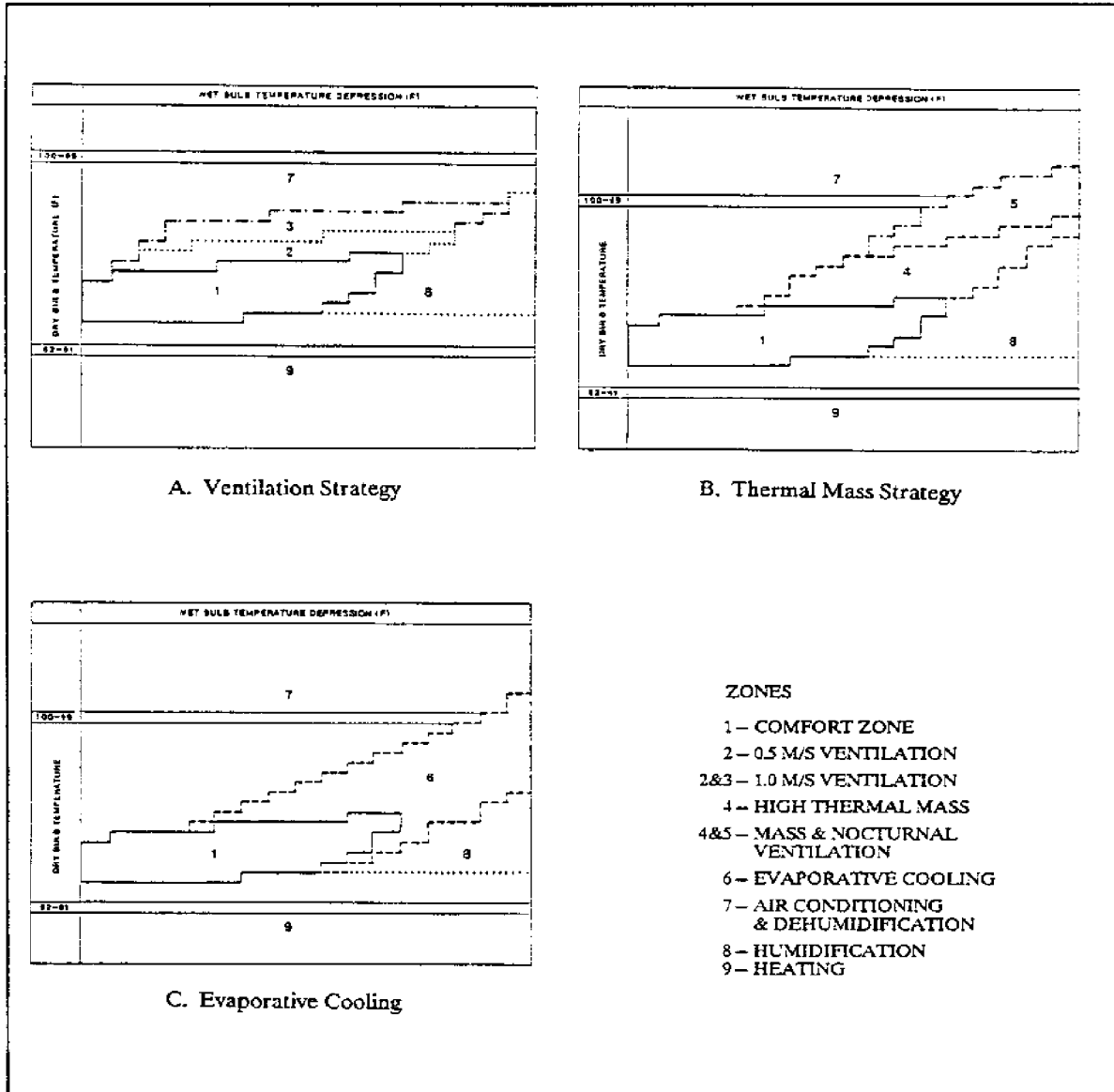

Figure B-7
Determining the Cooling Strategy

MIL-HDBK-1011/2
APPENDIX B (continued)

2.1 Annual Summary--Cooling. Using the annual psychrometric summary and the overlays, (Figures B-1 to B-3) sum the percentage of time within the boundary for each strategy and the comfort zone. A 197 fpm (1.0 m/sec) ventilation rate comprises zones 1 to 3. When summing the percentages, count four 0.0 percentages as equivalent to one 0.1 percent throughout the method. This is necessary because percentages less than 0.05 are rounded to 0.0 in the climate data summaries. The average of such rounded values is assumed to be 0.025.

In general, hot-humid climates require provisions for ventilation for bodily comfort, and hot-arid climates require either high thermal mass or evaporative cooling for bodily cooling, with nocturnal ventilation for structural cooling. Refer to Section 2 for further description of bodily and structural cooling.

2.2 Monthly Summaries--Cooling. Follow the same procedure using the monthly psychrometric summaries to observe what periods of the year that the natural cooling strategy will apply. If more than one cooling strategy is indicated, then a zoned or seasonally adjustable envelope may be desirable. Refer to para. 3.2 of the main text for further discussion of zoned and seasonally adjustable building envelopes.

STEP 3: DETERMINING NEED FOR MECHANICAL AIR CONDITIONING

3.1 Annual Summary--Air Conditioning. Using the air conditioning overlay (Figure B-4) and the annual psychrometric chart, sum the percentage frequency of hours hotter or more humid than the natural cooling strategy(s). On the overlay, this is the area above the boundary for the strategy (zone 7). If the total hours above the boundary exceeds 5 percent annually, an air conditioning system will be needed and the building envelope must be capable of restricting air infiltration to less than 0.5 air changes per hour. This eliminates porous wall constructions such as louvered walls and jalousie windows which cannot be shut tightly.

3.2 Monthly Summaries--Air Conditioning. For seasonal requirements, repeat the same procedure using the monthly charts to determine which months will require mechanical air conditioning for more than 10 percent of the time. If mechanical air conditioning is required for less than 10 percent of the time during the month, then the natural cooling strategy is viable for that month and the air conditioning system can be turned off. In zoned buildings, naturally ventilated spaces will be comfortable for that month. If mechanical air conditioning or an infiltration-resistant envelope is required, skip Step 4 and go to Step 5.

STEP 4: DETERMINING NEED FOR AN INFILTRATION-RESISTANT ENVELOPE

Skip this step if an air conditioning system is to be used. If an air conditioning system is used, infiltration must be limited to 0.5 air changes per hour.

MIL-HDBK-1011/2
APPENDIX B (continued)

4.1 Annual Summary--Infiltration. Using the annual psychrometric chart, determine the percentage time below 67deg.F (19deg.C). See Figure B-8. If more than 10 percent of the annual hours are less than 67deg.F (19deg.C), then an insulated building capable of holding infiltration to under one air change per hour is required. This eliminates porous wall constructions such as louvered walls which cannot be tightly shut. Operable louver windows which can be shut may be acceptable, but fixed open louvers should be avoided.

The upper limit of the climatic data bin directly below the comfort zone is 67deg.F (19deg.C). The 10 percent exceedence criterion may seem high, but the coldest periods of the day occur when the occupants are in bed under blankets. The insulation of blankets extends the comfort zone to lower temperatures, so the amount of time that discomfort is experienced is considerably less than 10 percent.

4.2 Monthly Summaries--Infiltration. If an infiltration-resistant envelope is required, then this procedure may be examined using the monthly psychrometric summaries to determine possible seasonal variations.

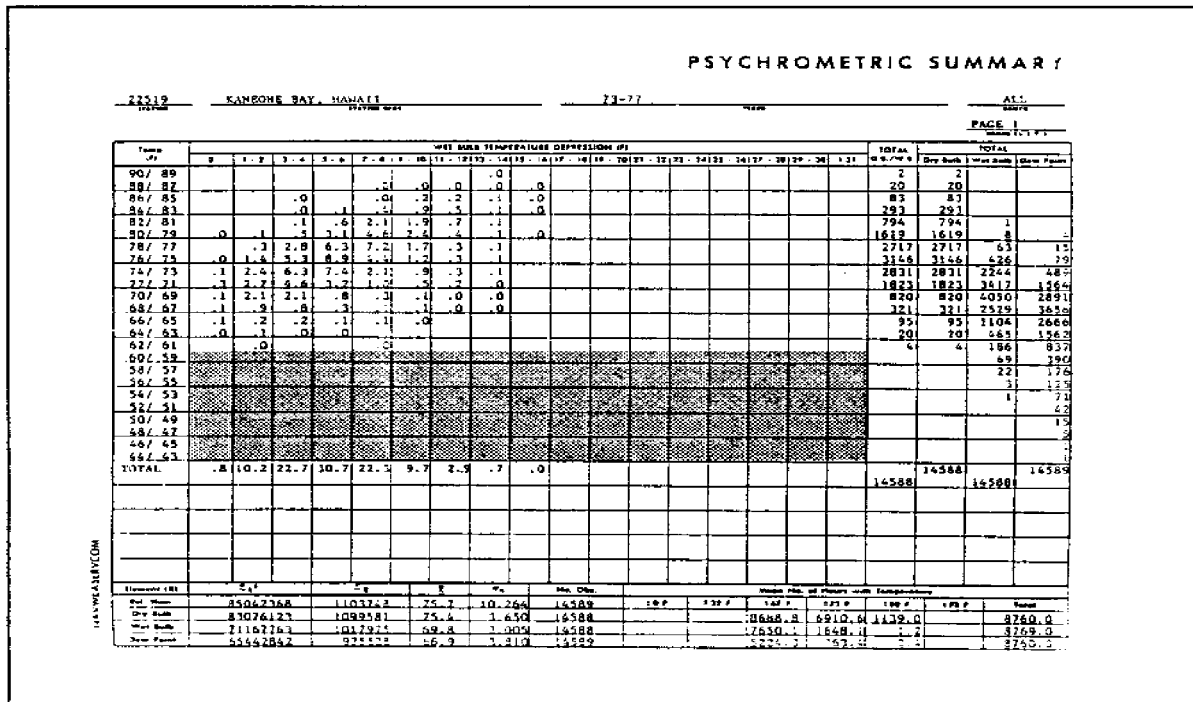

Figure B-8
Determining Requirement for Open or Infiltration-Resistant Envelope

MIL-HDBK-1011/2
APPENDIX B (continued)

STEP 5: DETERMINING NEED FOR HEATING EQUIPMENT

5.1 Annual Summary--Heating. Using the annual psychrometric chart, determine the percentage of time below 61deg.F (16deg.C). See Figure B-9. If more than 10 percent of the annual hours are less than 61deg.F, auxiliary heating will be required. In addition, the building envelope must be capable of holding infiltration to less than 0.5 air changes per hour, which eliminates jalousie windows and other openings which cannot be tightly shut.

The 60deg.F value corresponds to the upper limit of the bin below a typical balance point of a free-floating residential building with roof and wall insulation and air exchanges restricted to 0.5 ACH.

5.2 Monthly Summaries--Heating. Repeat the same procedure to determine seasonal requirements for heating using the monthly psychrometric charts. If heating is required for more than 25 percent of the time during the month, then the natural cooling strategy will not be applicable and the auxiliary heating system will be used during that month.

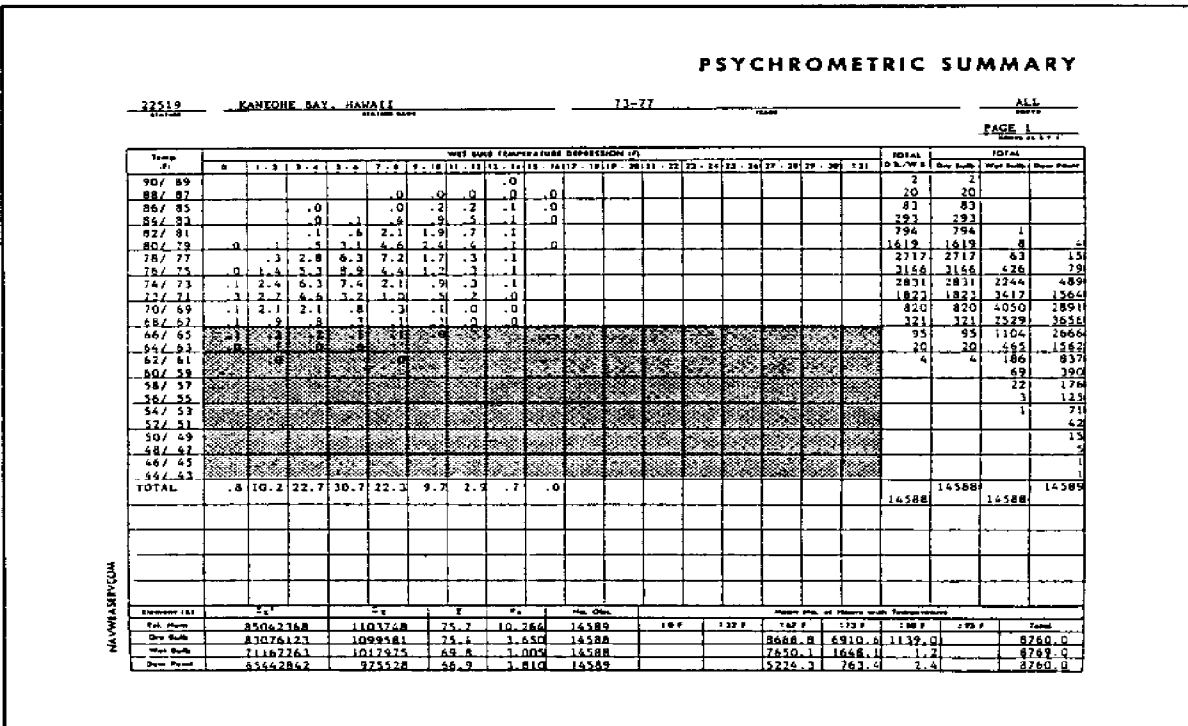

Figure B-9
Determining Heating Requirement

MIL-HDBK-1011/2
APPENDIX B (continued)

Any cooling strategy involving large openings in the building envelope will not be appropriate during months when appreciable heating is required unless the openings can be closed to thermal and infiltrative losses. For one possible method, refer to para. 3.2 in the main text.

5.3 Using Thermal Mass for Heating. The natural cooling strategy using thermal mass might also act to reduce auxiliary heating requirements if the heat losses occur during the daily minimum temperatures, and are relieved the same day by a substantial temperature rise.

STEP 6: DETERMINING THE MONTHLY FEASIBILITY OF A COOLING STRATEGY

6.1 Feasibility of Natural Cooling. The cooling strategy shall be evaluated as follows:

a) If the chosen natural cooling strategy is applicable for four months or more (i.e., heating and air conditioning are required for less than 8 months), then the strategy is effective and must be used in the building design.

b) If the most suitable strategy is natural ventilation, then go to STEP 7 (section 8) to determine whether ceiling fans are required.

c) If the number of months when air conditioning and heating are required is greater than 8, then the natural cooling strategy may be used seasonally or zonally to reduce loads on the required mechanical systems. In this case, para. 3.2 and Section 4 of this handbook may be used in conjunction with MIL-HDBK-1190 and DM 3.03 for design recommendations and specifications. A life-cycle cost analysis can be used to determine whether the natural cooling strategy will be cost effective and should be used.

STEP 7: DETERMINING NEED FOR CEILING OR WHOLE-HOUSE FANS

7.1 Procedure. It may be necessary to include back-up ventilation using a ceiling or whole-house fan to ensure comfort when wind-driven ventilation is inadequate. Ceiling fans can increase the interior ventilation caused by wind through the windows. If the window sizing (refer to Appendix C, Section 1) provides a ventilation rate of 98 fpm (0.5 m/sec) during periods when 197 fpm (1 m/sec) is required, ceiling fans can be used to provide the additional ventilation required for comfort.

Fans are required in all major occupied spaces of naturally ventilated buildings when comfort cannot be achieved by natural ventilation alone. The requirement is determined by the following procedure:

a) If an SMOS summary is available, use Part E "Percentage Frequency of Air Temperature versus Wind Directions" for the two hottest months of the year as determined in STEP 3. If the total percent time that is calm and above 81deg.F (deg.C)*** is greater than 10 percent for either month, then fans must be installed.

MIL-HDBK-1011/2
APPENDIX B (continued)

b) If only a RUSSWO summary is available, use the two hottest months of the year as determined in STEP 3. From Part C, "Surface Winds", determine the total percent calm for these months, as follows.

(1) Add the percentage of time within the natural ventilation boundary (STEP 2) and the percent above the boundary (STEP 3) for each of the two months to determine the total time above the comfort zone boundary.

(2) Multiply the percent time calm by the total time above the comfort zone boundary for the month and divide by 100.

If result is greater than 10 percent for either month, then fans must be installed.

Proceed with schematic site and building design, using the appropriate concepts and design strategies as discussed in Sections 2, 3, and 4.

Figure B-10 is a flowchart of the climatic design process. Figure B-11 presents a blank worksheet and example worksheets for four climates in Hawaii.

MIL-HDBK-1011/2
APPENDIX B (continued)

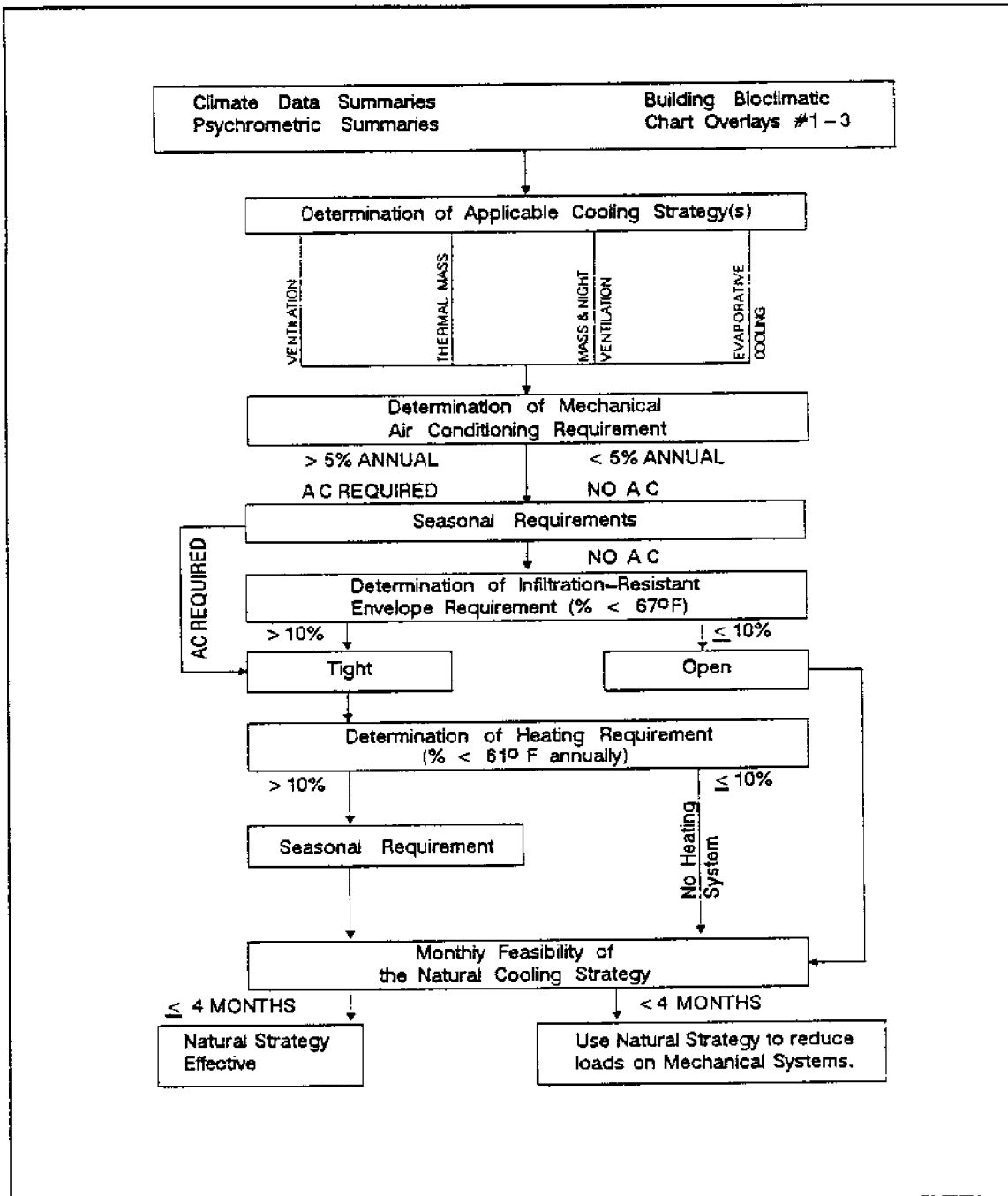

Figure B-10
Preliminary Climatic Analysis

MIL-HDBK-1011/2
APPENDIX B (continued)

CLIMATE ANALYSIS SUMMARY WORKSHEET

STEP 1: Station Name: _____ Prepared By: _____
 Data Years: _____ Date Prepared: _____

STEP 2: Determination of Natural Cooling Strategy

Comitant (Zone 1): _____
 Ventilation: 0.5m/s (zones 1 & 2)
 Thermal Mass (zones 1 & 4)
 Mass + Night Ventilation (z 1, 4 & 5)
 Evaporative Cooling (zones 1 & 6)

Annual % _____

Monthly % of Best Two Strategies:

JAN	FEB	MAR	APR	MAY	JUN	JUL	AUG	SEP	OCT	NOV	DEC

STEP 3: Determination of Mechanical Air Conditioning Requirement

Annual % Above Boundary (zone 7): _____
 Monthly % Above Strategy Boundary (zone 7):

JAN	FEB	MAR	APR	MAY	JUN	JUL	AUG	SEP	OCT	NOV	DEC

Best Strategy: _____
 2nd Best Strategy: _____
 If annual % < 5%, then a.c. is not required.
 If annual % > 5%, then a.c. is required, and the building must have TIGHT ENVELOPE. Go to Step 5.

STEP 4: Determination of Infiltration-Resistant Envelope Requirement

% Below 67°F: _____
 Annual % _____
 If < 10%, Open Envelope O.K. Go To Step 6.
 If > 10%, Infiltration-Resistant Envelope Required.
 Can be Examined Monthly to Determine Possible Seasonal Variations:

JAN	FEB	MAR	APR	MAY	JUN	JUL	AUG	SEP	OCT	NOV	DEC

% Below 67°F: _____

STEP 5: Determination of Heating Requirement

% Below 61°F: _____
 Annual % _____
 If < 10%, No Auxiliary Heating System. Go to Step 6.
 If > 10%, Heating Required. Examine Monthly %:

JAN	FEB	MAR	APR	MAY	JUN	JUL	AUG	SEP	OCT	NOV	DEC

% Below 61°F: _____
 If Monthly percentage > 25%, place an "X" in the monthly square above.

STEP 6: Monthly Feasibility of Natural Strategy

If there is an "X" in a square in Steps 3 or 5 above, place an "X" in same month below:

JAN	FEB	MAR	APR	MAY	JUN	JUL	AUG	SEP	OCT	NOV	DEC

Best Strategy: _____
 2nd Best Strategy: _____

If the natural cooling strategy works for ≥ 4 months (i.e. 4 or more open squares), include the natural cooling strategy in design. See Sections 3 and 4 for design requirements and recommendations.
 If the natural cooling strategy works for < 4 months (i.e. 9 or more X's), optional use of the strategy seasonally and/or zonally to reduce loads on mechanical system is recommended.

STEP 7: Determination of Fan Ventilation Requirement

1. If using SMOS: total time calm and > 81°F: _____
 2. If using RUISSWO: a. Time within ventilation boundary (from STEP 2): _____
 b. Time above ventilation boundary (from STEP 3): _____
 c. Time calm (from Part C, Surface Winds): _____
 d. (% calm) * (within boundary + above boundary): i.e. (a + b) _____

If percent time in line 1 or 2d is greater than 10%, then ceiling or whole-house fans must be installed.

1st hottest month: _____
 2nd hottest month: _____

Figure B-11
Climatic Analysis Summary Worksheet
Page 1 of 5

MIL-HDBK-1011/2
APPENDIX B (continued)

CLIMATE ANALYSIS SUMMARY WORKSHEET

STEP 1: Station Name: Barbetts Point, Hawaii Prepared By: N. S. W.
 Date Year: 1992-77 SHOS Date Prepared: 8/85

STEP 2: Determination of Natural Cooling Strategy

Comfort (zone 1)	Annual %	Monthly % of Best Two Strategies:											
Ventilation: 0.5m/s (zones 1 & 2)	54.7	JAN	FEB	MAR	APR	MAY	JUN	JUL	AUG	SEP	OCT	NOV	DEC
Thermal Mass (zones 1, 2 & 3)	81.4	86.0	80.0	90.0	91.4	91.0	83.7	72.8	66.8	63.7	74.7	88.8	85.7
Mass + Night Ventilation (zones 1 & 4)	93.0	88.7	81.9	92.0	95.4	99.3	99.5	99.3	98.0	96.3	98.4	96.8	91.3
Evaporative Cooling (zones 1 & 6)	82.6	78.6	87.7	87.0	90.1	94.2	94.2	90.5	69.7	64.7	77.9	83.3	83.5

STEP 3: Determination of Mechanical Air Conditioning Requirement

Monthly % Above Boundary (zone 7):

Annual %	JAN	FEB	MAR	APR	MAY	JUN	JUL	AUG	SEP	OCT	NOV	DEC
0.7	0	0	0	0	0	0.2	0.3	2.2	3.4	1.6	0	0.1

Best Strategy: 1.0 m/s If annual % < 5%, then a.c. is not required.
 2nd Best Strategy: Mass + Night V. If annual % > 5%, then a.c. is required, and the building must have TIGHT ENVELOPE. Go to Step 5.

STEP 4: Determination of Infiltration-Resistant Envelope Requirement

% Below 67°F: 4.6

% Below 67°F: 0.3

STEP 5: Determination of Heating Requirement

% Below 61°F: 0.3

STEP 6: Monthly Feasibility of Natural Strategy

If there is an "X" in a square in Steps 3 or 5 above, place an "X" in same month below:

Best Strategy: <u>1.0 m/s</u>	JAN	FEB	MAR	APR	MAY	JUN	JUL	AUG	SEP	OCT	NOV	DEC
2nd Best Strategy: <u>Mass + Night V.</u>												

If the natural cooling strategy works for ≥ 4 months (i.e. 4 or more open squares), include the natural cooling strategy in design. See Sections 3 and 4 for design requirements and recommendations.
 If the natural cooling strategy works for < 4 months (i.e. 9 or more X's), optional use of the strategy seasonally and/or zonally to reduce loads on a mechanical system is recommended.

STEP 7: Determination of Fan Ventilation Requirement

1. If using SMOS: real time calm and > 8) of: Hottest month: _____
 2. If using ROUSSWO: a. Time within ventilation boundary (from STEP 2): 2nd hottest month: _____
 b. Time above ventilation boundary (from STEP 3): _____
 c. Time calm (from Part C, Surface Winds): _____
 d. (% calm) * (within boundary + above boundary): [c * (a + b)] _____
 If percent time in line 1 or 2d is greater than 10%, then ceiling or whole-house fans must be installed.

Figure B-11
Climatic Analysis Summary Worksheet
Page 2 of 5

MIL-HDBK-1011/2
APPENDIX B (continued)

CLIMATE ANALYSIS SUMMARY WORKSHEET

STEP 1: Station Name: Hickam AFB (Honolulu)
Data Years: 1970-79 RUSSMO

Prepared By: N. S. W.
Date Prepared: 8/85

STEP 2: Determination of Natural Cooling Strategy

Comfort (zone 1)	Annual %
Ventilation: 0.5m/s (zones 1 & 2)	54.8
1.0m/s (zones 1, 2 & 3)	84.1
Thermal Mass (zones 1 & 4)	96.0
Mass + Night Ventilation (z 1, 4 & 5)	86.9
Evaporative Cooling (zones 1 & 6)	79.0

Monthly % of Best Two Strategies:

JAN	FEB	MAR	APR	MAY	JUN	JUL	AUG	SEP	OCT	NOV	DEC
82.4	85.7	93.0	94.0	90.0	82.0	66.1	62.1	72.5	78.8	90.0	89.5
83.1	87.0	94.6	97.1	99.9	99.8	90.0	98.0	99.1	99.1	97.1	91.7
77.4	83.9	91.5	95.1	92.2	89.5	87.7	75.9	77.6	76.0	85.7	82.4

STEP 3: Determination of Mechanical Air Conditioning Requirement

Annual % Above Boundary (zone 7):

Best Strategy: 1.0 m/s	Annual %
2nd Best Strategy: 0.5 m/s	0.5
1.2 m/s	12.4

If annual % < 5%, then a.c. is not required.
If annual % > 5%, then a.c. is required, and the building must have TIGHT ENVELOPE. Go to Step 5.

Monthly % Above Strategy Boundary (zone 7):

JAN	FEB	MAR	APR	MAY	JUN	JUL	AUG	SEP	OCT	NOV	DEC
0.1	0	0	0	0	0	0	0	0	0	0	0
0.4	1.3	1.1	3.2	9.2	18.7	27.4	30	27.4	21.0	9.7	0.1

If Monthly percentage > 10%, place an "X" in the monthly square above.

STEP 4: Determination of Infiltration-Resistant Envelope Requirement

% Below 67°F: _____ Annual % _____

% Below 67°F: _____ Annual % _____

If < 10%, Open Envelope O.K. Go To Step 6.
If > 10%, Infiltration-Resistant Envelope Required.
Can be Examined Monthly to Determine Possible Seasonal Variations:

JAN	FEB	MAR	APR	MAY	JUN	JUL	AUG	SEP	OCT	NOV	DEC

STEP 5: Determination of Heating Requirement

% Below 61°F: _____ Annual % _____

% Below 61°F: _____ Annual % _____

If < 10%, No Auxiliary Heating System. Go to Step 6.
If > 10%, Heating Required. Examine Monthly %:

JAN	FEB	MAR	APR	MAY	JUN	JUL	AUG	SEP	OCT	NOV	DEC

If Monthly percentage > 25%, place an "X" in the monthly square above.

STEP 6: Monthly Feasibility of Natural Strategy

If there is an "X" in a square in Steps 3 or 5 above, place an "X" in same month below:

JAN	FEB	MAR	APR	MAY	JUN	JUL	AUG	SEP	OCT	NOV	DEC

Best Strategy: 1.0 m/s
2nd Best Strategy: 0.5 m/s

If the natural cooling strategy works for > 4 months (i.e. 4 or more open squares), include the natural cooling strategy in design. See Sections 3 and 4 for design requirements and recommendations.
If the natural cooling strategy works for < 4 months (i.e. 0 or more X's), optional use of the strategy seasonally and/or zonally to reduce loads on mechanical system is recommended.

STEP 7: Determination of Fan Ventilation Requirement

- If using SMOS: total time calm and > 81°F: _____
 - If using RUSSWO:
 - Time within ventilation boundary (from STEP 2): _____
 - Time within ventilation boundary (from STEP 3): _____
 - Time calm (from Part C, Surface Winds): _____
 - (% calm) * (within boundary + above boundary): $1c * (a + b)$ _____
- If percent time in line 1 or 2 is greater than 10%, then ceiling or whole-house fans must be installed.

Hottest month: _____
2nd hottest month: _____

Figure B-11

Climatic Analysis Summary Worksheet
Page 3 of 5

MIL-HDBK-1011/2
APPENDIX B (continued)

CLIMATE ANALYSIS SUMMARY WORKSHEET

STEP 1: Station Name: Kaneohe Bay, Hawaii
Data Years: 1973-77 SMOSS /RUSSHO

Prepared By: N.S.W.
Date Prepared: 1/86

STEP 2: Determination of Natural Cooling Strategy

Annual %
Comfort (zone 1) 61.8
Ventilation: 0.5m/s (zones 1 & 2) 96.6
1.0m/s (zones 1, 2 & 3) 99.9
Thermal Mass (zones 1 & 4) 75.5
Mass + Night Ventilation (z 1, 4 & 5) 75.5
Evaporative Cooling (zones 1 & 6) 74.9

Monthly % of Best Two Strategies:

JAN	FEB	MAR	APR	MAY	JUN	JUL	AUG	SEP	OCT	NOV	DEC
88.5	94.3	97.7	97.8	99.6	98.3	96.8	90.8	85.4	92.7	96.6	97.0
99.6	94.8	98.1	98.1	100	99.8	99.5	99.5	99.1	99.7	99.8	97.5

STEP 3: Determination of Mechanical Air Conditioning Requirement

Annual % Above Boundary (zone 7):

Annual %
Best Strategy: 1.0 m/s 0.1
2nd Best Strategy: 0.5 m/s 3.4

If annual % < 5%, then a.c. is not required.
If annual % > 5%, then a.c. is required, and the building must have TIGHT ENVELOPE. Go to Step 5.

Monthly % Above Strategy Boundary (zone 7):

JAN	FEB	MAR	APR	MAY	JUN	JUL	AUG	SEP	OCT	NOV	DEC
0.1	0	0	0.1	0	0	0.2	0.2	0.9	0.1	0.2	0
2.0	0.5	0.4	0.4	0.4	1.7	3.2	2.2	7.4	1.3	2.3	0.5

If Monthly percentage > 10%, place an "X" in the monthly square above.

STEP 4: Determination of Infiltration-Resistant Envelope Requirement

% Below 67°F: 0.95

% Below 69°F: 0

Can be Examined Monthly to Determine Possible Seasonal Variations:

JAN	FEB	MAR	APR	MAY	JUN	JUL	AUG	SEP	OCT	NOV	DEC

STEP 5: Determination of Heating Requirement

% Below 63°F: 0

% Below 61°F: 0

If < 10% Open Envelope O.K. Go To Step 6.
If > 10% Infiltration-Resistant Envelope Required.
If Monthly percentage > 25%, place an "X" in the monthly square above.

JAN	FEB	MAR	APR	MAY	JUN	JUL	AUG	SEP	OCT	NOV	DEC

STEP 6: Monthly Feasibility of Natural Strategy

If there is an "X" in a square in Steps 3 or 5 above, place an "X" in same month below:

JAN	FEB	MAR	APR	MAY	JUN	JUL	AUG	SEP	OCT	NOV	DEC
									X		

Best Strategy: 1.0 m/s
2nd Best Strategy: 0.5 m/s

If the natural cooling strategy works for ≥ 4 months (i.e. 4 or more open squares), include the natural cooling strategy in design. See Sections 3 and 4 for design requirements and recommendations.
If the natural cooling strategy works for < 4 months (i.e. 0 or more X's), optional use of the strategy seasonally and/or totally to reduce loads on mechanical system is recommended.

STEP 7: Determination of Fan Ventilation Requirement

1. If using SMOSS: total time calm and > 81°F:
2. If using RUSSWO: a. Time within ventilation boundary (from STEP 2):
b. Time above ventilation boundary (from STEP 2):
c. Time calm (from Part C, Surface Winds):
d. (% calm) * (within boundary + above boundary) [c * (a + b)]

If percent time in line 1 or 2d is greater than 10%, then ceiling or whole-house fans must be installed.

Hottest month	Sept	2nd hottest month	Aug
85.6	90.8	9.2	9.2
14.4	9.2	9.2	9.2
5.4	7.2	7.2	7.2

Figure B-11
Climatic Analysis Summary Worksheet
Page 4 of 5

MIL-HDBK-1011/2
APPENDIX B (continued)

CLIMATE ANALYSIS SUMMARY WORKSHEET

STEP 1: Station Name: Muscatel, APR, Haven 11
Data Years: 1968=70, 1973=79, RUSSMO.

Prepared By: N.S.M.
Date Prepared: 8/85

STEP 2: Determination of Natural Cooling Strategy

Annual %
Comfort (zone 1): 63.4
Ventilation: 0.5m/s (zones 1 & 2), 84.9
1.0m/s (zones 1, 2 & 3), 90.6
Thermal Mass (zones 1 & 4): 83.3
Mass + Night Ventilation (z 1, 4 & 5): 83.3
Evaporative Cooling (zones 1 & 6): 81.1

Monthly % of Best Two Strategies:

JAN	FEB	MAR	APR	MAY	JUN	JUL	AUG	SEP	OCT	NOV	DEC
74.5	74.1	82.2	88.1	95.1	97.9	99.1	98.6	98.6	87.5	90.6	84.0
74.5	74.1	82.2	88.1	95.1	97.9	99.1	98.6	98.6	87.5	92.6	84.3

STEP 3: Determination of Mechanical Air Conditioning Requirement

Annual % Above Boundary (zone 7):
Best Strategy: 1.0 m/s Annual % 0.3
2nd Best Strategy: 0.5 m/s Annual % 6.0
If annual % < 5%, then a.c. is not required.
If annual % > 5%, then a.c. is required, and the building must have TIGHT ENVELOPE. Go to Step 5.

Monthly % Above Strategy Boundary (zone 7):

JAN	FEB	MAR	APR	MAY	JUN	JUL	AUG	SEP	OCT	NOV	DEC
0	0	0	0	0	0	0.1	0.1	0.8	0.5	0.1	0
0	0	0	0.3	2.7	6.6	11.8	16.9	16.9	10.4	2.0	0.3

If Monthly Percentage > 10%, place an "X" in the monthly square above.

STEP 4: Determination of Infiltration-Resistant Envelope Requirement

% Below 67°F: 10.0
% Below 67°F: _____

Can be Examined Monthly to Determine Possible Seasonal Variations:

JAN	FEB	MAR	APR	MAY	JUN	JUL	AUG	SEP	OCT	NOV	DEC

STEP 5: Determination of Heating Requirement

% Below 61°F: 1.2
% Below 61°F: _____

If < 10%, Open Envelope O.K. Go To Step 6.
If > 10%, Infiltration-Resistant Envelope Required.
Can be Examined Monthly to Determine Possible Seasonal Variations:

JAN	FEB	MAR	APR	MAY	JUN	JUL	AUG	SEP	OCT	NOV	DEC

If Monthly Percentage > 25%, place an "X" in the monthly square above.

STEP 6: Monthly Feasibility of Natural Strategy

If there is an "X" in a square in Steps 3 or 5 above, place an "X" in same month below:

Best Strategy: 1.0 m/s
2nd Best Strategy: 0.5 m/s

JAN	FEB	MAR	APR	MAY	JUN	JUL	AUG	SEP	OCT	NOV	DEC

If the natural cooling strategy works for > 4 months (i.e. 4 or more open squares), include the natural cooling strategy in design. See Sections 3 and 4 for design requirements and recommendations.

If the natural cooling strategy works for < 4 months (i.e. 9 or more "X"s), optional use of the strategy seasonally and/or zonally to reduce loads on mechanical system is recommended.

STEP 7: Determination of Fan Ventilation Requirement

1. If using SMOGS: total time calm and > 81°F: _____
2. If using RUSSWO: a. Time within ventilation boundary (from STEP 2): _____
b. Time above ventilation boundary (from STEP 3): _____
c. Time calm (from Part C, Surface Winds): _____
d. (% calm) * (within boundary + above boundary): [c * (a + b)] _____

If percent time in line 1 or 2d is greater than 10%, then ceiling or whole house fans must be installed.

Hottest month: _____
2nd hottest month: _____

Figure B-11
Climatic Analysis Summary Worksheet
Page 5 of 5

MIL-HDBK-1011/2
APPENDIX B (continued)

PAGE 100 INTENTIONALLY LEFT BLANK

MIL-HDBK-1011/2

APPENDIX C
PREDICTION AND EVALUATION METHODS

MIL-HDBK-1011/2
APPENDIX C (continued)

THIS PAGE INTENTIONALLY LEFT BLANK

MIL-HDBK-1011/2
APPENDIX C (continued)

CONTENTS

Section	1	AIR MOVEMENT BY NATURAL VENTILATION	105
	1.1	Window Sizing Procedure	105
	1.1.1	Required Total Window Areas	105
	1.1.2	Check for Required Airspeed	111
	1.2	ASHRAE Wind and Thermal Buoyancy (Stack Effect) Formulae	113
	1.2.1	Flow Due to Wind--Single Opening	113
	1.2.1.1	Estimating Quantity of Inlet Air	114
	1.2.2	Flow Due to Wind--Openings in Series	115
	1.2.2.1	Flow Volume	115
	1.2.2.2	Flow Velocity	115
	1.2.2.3	Discharge Coefficient for Varying Wind Angles	115
	1.2.3	Flow Due to Thermal Forces	115
	1.2.4	Combining Terms	116
	1.3	Wind Tunnel Testing	116
	1.3.1	Wind Tunnel Test Facilities	116
	1.3.1.1	Variations from Theoretical Mean	116
	1.3.1.2	Profile Limitations	117
	1.3.2	Wind Tunnel Models	117
	1.3.2.1	Model Detail	117
	1.3.2.2	Immediate Surroundings	118
	1.3.2.3	Model Size and Wind Tunnel Speed	118
	1.3.2.4	Reynolds Number for Flow Around Bluff Bodies	118
	1.3.2.5	Reynolds Number for Flow Through Window Openings	118
	1.3.2.6	Reynolds Number for Flow through Ductways	119
	1.3.2.7	Reynolds Number for Flow in a Room	119
	1.3.2.8	Reynolds Number for Flow Through Screens and Louvers	119
	1.3.2.9	Reynolds Numbers--Reducing Margin of Error	119
	1.3.2.10	Model Size Limitations	119
	1.3.3	Instrumentation	120
	1.3.3.1	Velocity Measurements	120
	1.3.3.2	Pressure Measurements	120
	1.3.4	Wind Tunnel Test Procedures	120
	1.3.4.1	Procedure 1--Direct Velocity Measurement	120
	1.3.4.2	Procedure 2--Indirect Velocity Measurement	121
	1.3.4.3	Procedure for High-Rise Buildings	122
	1.3.5	Use of Wind Tunnel Air Flow Rates	122
	1.4	Field Modeling	122
	1.4.1	Model Requirements	123
	1.4.2	Applicable Buildings	123
	1.4.3	Types of Tests	123
Section	2	INTERIOR TEMPERATURES	125
	2.1	Purpose	125
	2.1.1	Internal Gain and Interior Temperature Rise	125
	2.2	Equations	125
	2.2.1	Temperature Rise	125
	2.2.2	Ventilation Boundary Adjustment	125
	2.3	Computer Models of Interior Temperatures	126
	2.3.1	Program Inputs and Outputs	126

MIL-HDBK-1011/2
APPENDIX C (continued)

	2.3.2	Program Limitations	126
	2.3.3	Computer Programs for Thermal Analysis	126
Section	3	OCCUPANT COMFORT	129
	3.1	The Bioclimatic Chart	129
	3.2	The J.B. Pierce Human Thermoregulatory System Model	129
Section	4	WHOLE-HOUSE FAN SIZING PROCEDURE	131
	4.1	Assumptions	131
	4.2	Minimum Required Airflow, CFM	131
	4.3	Fan Selection	131

FIGURES

Figure	C-1	Examples of Proper Width for Window Sizing Procedure .	105
	C-2	Pressure Coefficient Planes and Wind Incidence Angles for One- to Two-Story Buildings	107
	C-3	Pressure Coefficient Planes and Wind Incidence Angles for Two- to Six-Story Buildings	108
	C-4	Building Type Description	109
	C-5	Interior Partition Resistance Factors	110

TABLES

Table	C-1	Typical Average Surface Pressure Coefficients on the Walls of a Residential Scale (One-to Two-Story) Building	107
	C-2	Typical Average Surface Pressure Coefficients for Two- to Six-Story Buildings	108
	C-3	Pressure Coefficient Correction Factor, PCCF	109
	C-4	Terrain Correction Factor, TGF	110
	C-5	Resistance Factors, RF	110
	C-6	Typical Terrain Categories and Roughness Lengths	117

MIL-HDBK-1011/2
APPENDIX C (continued)

Section 1: AIR MOVEMENT BY NATURAL VENTILATION

1.1 Window Sizing Procedure.

1.1.1 Required Total Window Areas. This procedure is used to determine required total window inlet and outlet areas based on a specified interior air velocity. It is valid for rooms with only one interior partition, or open rooms in one to six story buildings without large interior gains. This procedure is based on work done at the Florida Solar Energy Center and documented in Chandra, et al. (1983), Outdoor Testing of Small Scale Naturally Ventilated Models. Figure C-1 illustrates window sizing measurements.

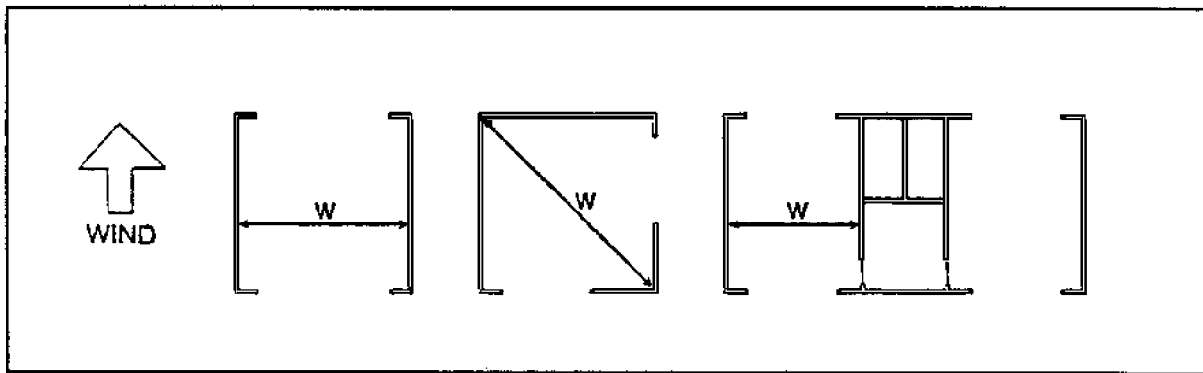

Figure C-1
Examples of Proper Width for Window Sizing Procedure

- (1) Required air velocity rate, V V =))))) fpm
from Climate Analysis.
- (2) Cross-sectional area of the room, CS H =)))) ft
Height of room, H W =)))) ft
Width of room across flow, W CS =)) ft. 2-
CS = H x W
- (3) Required airflow rate, CFM. CFM =)))) cfm
CFM = V x CS
- (4) Building location:)))))))) (city)
Weather Station location:))))))))

Using Climate Analysis, examine
worst two naturally ventilated months separately.
Design months:))))))))
- (5) Prevailing wind direction for month, WD. WD =)))) =))))

MIL-HDBK-1011/2
APPENDIX C (continued)

Pick predominant wind direction associated with the 82deg.F to 86deg.F band for the month. (This range roughly corresponds to conditions when ventilation is effective.)

(b) OPTION 2: If no SMOS exists for the location, use RUSSWO Part C--"Surface Winds." Pick predominant wind direction for month.

- (6) Wind speed for month, WS. WS =))))) knts =))))) knts
From SMOS or RUSSWO Part C--"Surface Winds", pick mean windspeed corresponding to direction chosen in Step 5 for the month.
- (7) Incidence angle on windward face, alpha, from site plan and prevailing wind direction, (see Figure C-2). a =))))) deg =))))) deg
- (8) From Table C-1 or C-2 determine:
(a) Windward pressure coefficient, WPC WPC =)))) =)))))
(b) Leeward pressure coefficient, LPC LPC =)))) =)))))
- (9) Pressure coefficient differential, PCD. PCD =)))) =)))))
PCD = WPC - LPC
- (10) For the surrounding neighborhood and the proposed building type, determine from Table C-3 the pressure coefficient correction factor, PCCF. PCCF =)))) =)))))
- (11) Calculate the revised pressure coefficient differential, PD. PD =)))) =)))))
PD = PCD x PCCF
- (12) Obtain terrain correction factor, TCF, from Table C-4. TCF =)))) =)))))
- (13) Compute revised meteorological wind speed in feet per minute, W. W =)))) fpm =)))) fpm
W = WS x TCF x 101.2
- (14) Calculate required open effective window area, A. A =))))) ft. 2- =)))) ft. 2-
A = (1.56 CFM) / [W x (PD)^{1/2}]
- (15) Select an open inlet area, A_i, > A. A_i, =))))) ft. 2- =)))) ft. 2-
Note: if equal inlet and outlet area are desired, A_i, = 1.41A.

MIL-HDBK-1011/2
APPENDIX C (continued)

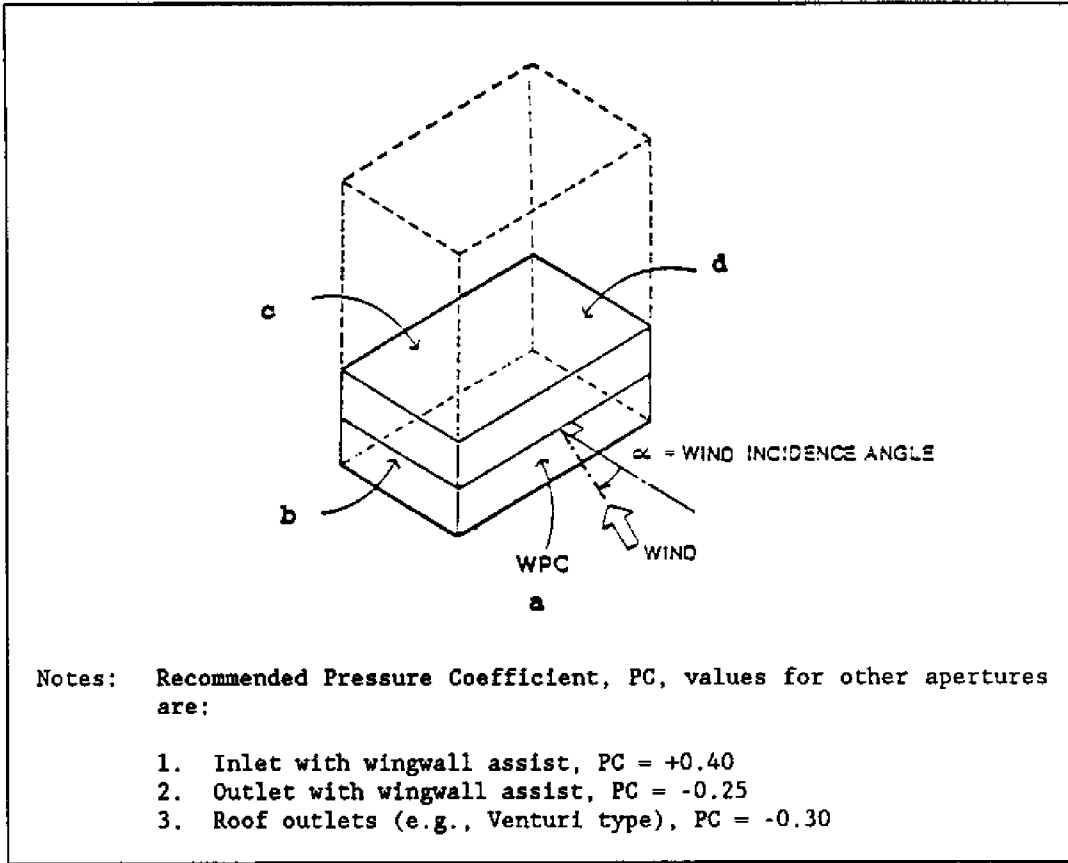

Figure C-2
Pressure Coefficient Planes and Wind Incidence Angles
for One- to Two-Story Buildings

Table C-1
Typical Average Surface Pressure Coefficients on the Walls
of a Residential Scale (one-to Two-Story) Building

Wind Angle "	Surface Pressure Coefficients, (PC)			
(Figure C-2)	a	b	c	d
0	+0.40	-0.40	-0.25	-0.40
22.5	+0.40	-0.06	-0.40	-0.60
45	+0.25	+0.25	-0.45	-0.45
67.5	-0.06	+0.30	-0.55	-0.40
90	-0.40	+0.40	-0.40	-0.25

MIL-HDBK-1011/2
APPENDIX C (continued)

Table C-2
Typical Average Surface Pressure Coefficients
for Two- to Six-Story Buildings

```
+))))))))))))))))))))))))))))))))))))))))))))))))))))))))))))))))))))))))))))))))))))))))))-,
*
*For Buildings with Square Floorplans
*
* Wind Angle "      Wall Surface Pressure Coefficients, (PC)
* (Figure C-3)      a          b          c          d
*
*    0              +0.80      -0.70      -0.30      -0.70
*    15             +0.80      -0.90      -0.50      -0.60
*    45             +0.50      +0.50      -0.50      -0.50
*    90             -0.70      -0.80      +0.70      -0.30
*
*
*For Buildings with Rectangular floorplans:
*
* Wind Angle "      Wall Surface Pressure Coefficients (PC)
* (Figure C-3)      a          b          c          d
*
*    0              +0.70      -0.70      -0.40      -0.70
*    45             +0.60      +0.40      -0.50      -0.40
*    90             -0.50      +0.80      -0.50      -0.20
*
*
*)))))))))))))))))))))))))))))))))))))))))))))))))))))))))))))))))))))))))))))))))))))))))))-
```

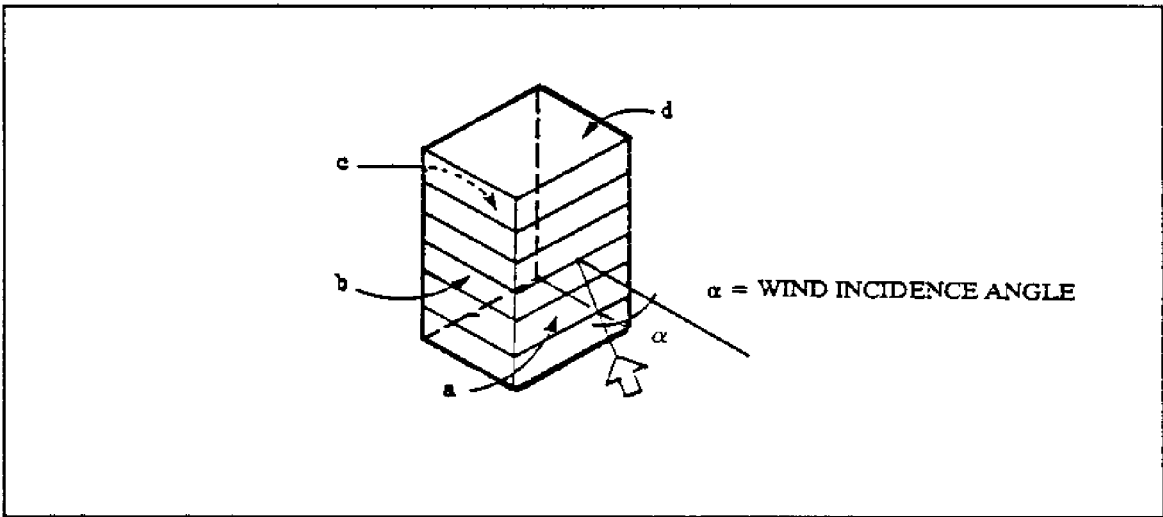

Figure C-3
Pressure Coefficient Planes and Wind Incidence Angles
for Two- to Six-Story Buildings

MIL-HDBK-1011/2
 APPENDIX C (continued)

Table C-3
 Pressure Coefficient Correction Factor, PCCF

+))))))))) ,
 *
 * 1) Wall height of typical upwind buildings, h =)))) ft *
 * 2) Gap between proposed building and adjacent upwind *
 * building, g =)))) ft *
 * 3) Ratio, g/h =))))))) *
 *
 *
 * PCCF for Building Types *
 * Ratio *
 * g/h * 1 * 2 * 3 * 4 * 5 *
 * - *
 * *
 * 0 0.00 0.00 0.00 0.00 0.00 0.00 *
 * 1 0.17 0.24 0.23 0.31 0.17 *
 * 2 0.40 0.57 0.54 0.72 0.39 *
 * 3 0.59 0.83 0.79 1.06 0.61 *
 * 4 0.73 1.03 0.98 1.32 0.74 *
 * 5 0.87 1.23 1.17 1.57 0.87 *
 * 6 or more 1.00 1.41 1.34 1.80 1.00 *
 * *
 .))))))))) -

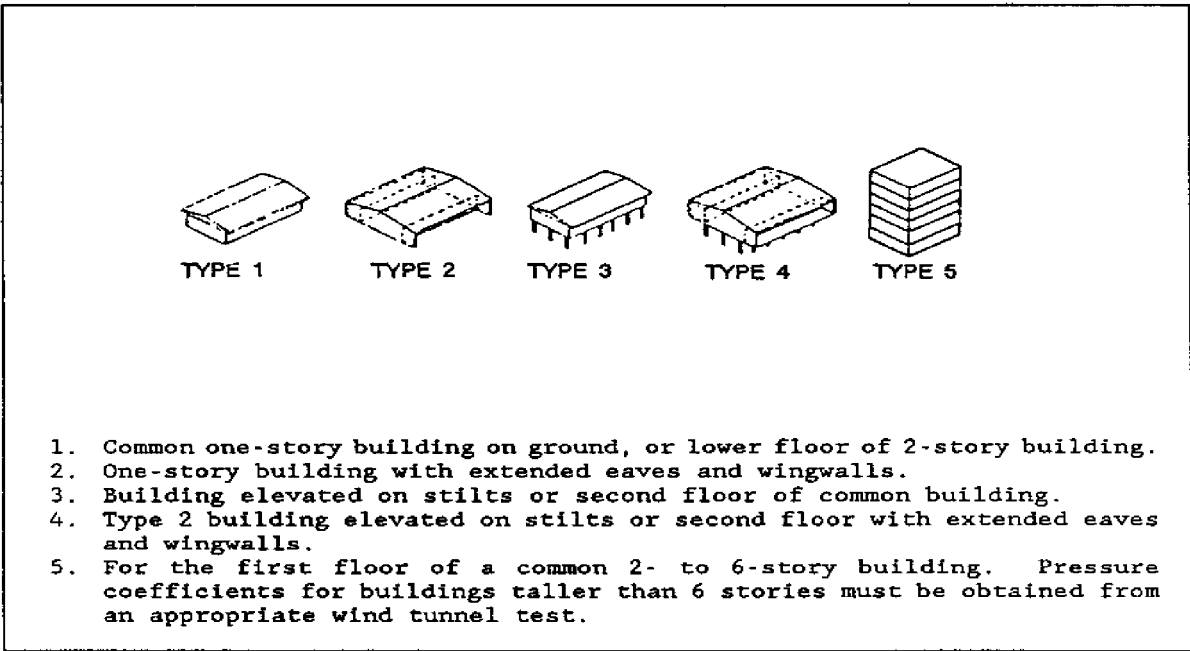

Figure C-4
 Building Type Description

MIL-HDBK-1011/2
APPENDIX C (continued)

Table C-4
Terrain Correction Factor (TCF)

| Terrain Type | Ventilation | |
|---|-------------|------------|
| | 24-hour | Night-only |
| 1. Oceanfront or >3 miles from water | 1.30 | 0.98 |
| 2. Flatlands with isolated, well-separated buildings (e.g., farmland) | 1.00 | 0.75 |
| 3. Rural or suburban | 0.85 | 0.64 |
| 4. Urban or industrial | 0.67 | 0.50 |
| 5. Center of large city | 0.47 | 0.35 |

Table C-5
Resistance Factors (RF)

*Resistance Factor: $RF = IPF \times WPF \times PF$

| | |
|---|-------------|
| 1. Insect Screening, IPF | Typical IPF |
| a. No screen | 1.00 |
| b. Bronze, 14 wires/inch | 0.80 |
| c. Fiberglass, 18 wires/inch | 0.60 |
| 2. Window Porosity, WPF | Typical WPF |
| a. Single or double hung | 0.40 |
| b. Awning, Hopper, Jalousie, or projections which swivel open on horizontal pivot | 0.60-0.90 |
| c. Casement | 0.50-0.90 |

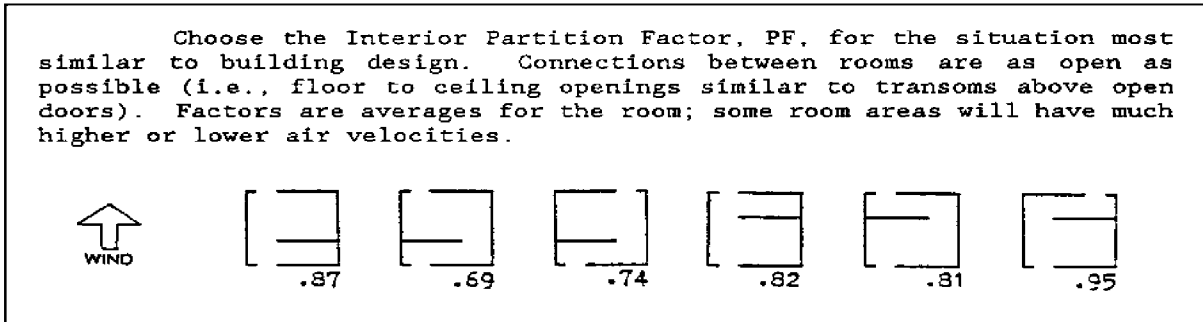

Figure C-5
Interior Partition Resistance Factors

MIL-HDBK-1011/2
APPENDIX C (continued)

- (16) Calculate open outlet area, A_o . $A_o = \text{)))))) ft}^2 = \text{)))))) ft}^2$
 $A_o = A \times A_i / [(A_i^2 - A^2)^{1/2}]$
- (17) Increase open areas calculated $RF = \text{)))))) = \text{))))))$
 above for resistance due to insect screens,
 partially open windows, partitions, etc.
 Find Resistance Factor (RF) from Table C-5.
- (18) Calculate TOTAL (not open) inlet and outlet window areas,
 TA_i , TA_o .
 $TA_i = A_i / RF$
 $TA_i = \text{)))) ft}^2 = \text{Total Req'd Inlet Area for worst month.}$
 $TA_i = \text{)))) ft}^2 = \text{Total Req'd Inlet Area for 2nd worst}$
 $TA_o = A_o / RFT$
 $A_o = \text{)))) ft}^2 = \text{Total Req'd Outlet Area for worst month.}$
 $TA_o = \text{)))) ft}^2 = \text{Total Req'd Outlet Area for 2nd worst month.}$

SUMMARY:

Required velocity, $V = \text{))))))))))$ Weather Station = $\text{))))))))))$
 Worst month = $\text{))))))))))$ 2nd worst month = $\text{))))))))))$
 Windspeed, $WS = \text{))))))))))$ Windspeed, $WS = \text{))))))))))$
 Wind direction, $WD = \text{))))))))))$ Wind direction, $WD = \text{))))))))))$
 Open inlet req'd, $TA_i = \text{))))))))))$ Open inlet req'd, $TA_i = \text{))))))))))$
 Open outlet req'd, $TA_o = \text{))))))))))$ Open outlet req'd, $TA_o = \text{))))))))))$

1.1.2 Check for Required Airspeed. This procedure is used to check adequacy of the proposed design. When the proposed schematic design is detailed enough to include site plan, building location, room dimensions, window details, and shading system, the following procedure can be used to determine whether the proposed design will provide the required interior air speed.

- (1) Required air velocity rate, V $V = \text{)))))) fpm}$
 from Climate Analysis.
- (2) Cross-sectional area of the room, CS $H = \text{)))))) ft}$
 Height of room, H
 Width of room across flow, W $W = \text{)))))) ft}$
 $CS = HW$ $CS = \text{)))))) ft}^2$
- (3) Required airflow rate, CFM.
 $CFM = VCS$ $CFM = \text{)))))) cfm}$
- (4) Building location = $\text{))))))))))$ (city)
 Weather Station location = $\text{))))))))))$

MIL-HDBK-1011/2
APPENDIX C (continued)

- From Climate Analysis, examine worst two naturally ventilated months separately. Month:)))))))
Month:)))))))
- (5) Prevailing wind direction for month, WD. WD=))))))) =)))))
- (a) OPTION 1: SMOS Part E--"Temperature versus "Wind Direction". Pick predominant wind direction associated with the 82 deg. to 86 deg. F band for the month.
- (b) OPTION 2: If no SMOS exists for the location, use RUSSWO Part C--"Surface Winds." Pick predominant wind direction for month.
- (6) Wind speed for month, WS. WS =)))) knts =)))) knts
From SMOS or RUSSWO Part C--"Surface Winds," pick mean wind speed corresponding to direction chosen in Step 5 for the month.
- (7) Incidence angle on windward face, alpha. alpha =)))) deg)))) deg
(See site plan and Figure C-2 or C-3).
- (8) From Table C-1 or C-2 determine:
- (a) Windward pressure coefficient, WPC WPC =))))))) =)))))))
- (b) Leeward pressure coefficient, LPC LPC =))))))) =)))))))
- (9) Pressure coefficient differential, PCD. PCD =))))))) =)))))))
PCD = WPC - LPC
- (10) For the surrounding neighborhood and the proposed building type, determine from Table C-3 the pressure coefficient correction factor, PCCF for the appropriate building type (Figure C-4).
Bldg. type no.)))) h =)))) g =))))
h/g =)))) PCCF =))))))) =)))))))
- (11) Calculate the revised pressure coefficient differential, PD. PD =)))) =))))
PD = PCD * PCCF
- (12) Obtain terrain correction factor, TCF, from Table C-4. Terrain type))))))) TCF =)))) =))))
- (13) Compute revised meteorological wind speed in feet per minute, W. W =)))) fpm =)))) fpm
W = WS * TCF * 101.2
- (14) Calculate required open effective window area, A. A =)))) ft² =))))
ft. 2-
A = (1.56 * CFM) / [W * (PD)^½]

MIL-HDBK-1011/2
APPENDIX C (continued)

- (15) Calculate the inlet window area $W_i = \text{))) ft}^2 = \text{))) ft}^2$
for the proposed design, W_i .
- (16) Correct using resistance factor, RF_i , $RF_i = \text{))))))) = \text{)))))))$
for partially open, windows, window
type, screens, etc., from Table C-5 and Figure C-6.
- (17) Calculate the effective open inlet are, A_i . $A_i = \text{))) ft}^2 = \text{))) ft}^2$
 $A_i = W_i \times RF_i$
- (18) Calculate required open outlet area, A_o . $A_o = \text{))) ft}^2 = \text{))) ft}^2$
 $A_o = A \times A_i / [(A_i^2 - A^2)^{1/2}]$
- (19) Calculate the outlet window area $W_o = \text{))) ft}^2 = \text{))) ft}^2$
for the proposed design, W_o .
- (20) Find the resistance factor, RF_o , $RF_o = \text{))))))) = \text{)))))))$
for the outlet openings from Table C-5.
- (21) Calculate the effective outlet opening,
 A_e . $A_e = \text{))) ft}^2 = \text{))) ft}^2$
 $A_e = W_o \times RF_o$.
- (22) Compare the required outlet opening with the
effective outlet opening:
Worst Month: $\text{)))))))$ 2nd worst month: $\text{)))))))$
 $A_o = \text{)))))))$ $A_o = \text{)))))))$
 $A_e = \text{)))))))$ $A_e = \text{)))))))$

If $A_o < A_e$, then the required air speed will be obtained and comfort can be expected. If $A_o > A_e$, then the required air speed will not be obtained.

If required air speed is not obtained, possible methods to obtain the required air speed are to:

- a) Increase the size of the openings.
- b) Increase the effectiveness of the openings by changing window type, removing screens, or removing interior partitions.
- c) Increase the pressure coefficients by spacing buildings farther apart, rotating the building, relocating windows, elevating the building, or adding wingwalls.

1.2 ASHRAE Wind and Thermal Buoyancy (Stack Effect) Formulae. The two driving forces producing natural ventilation in a building are wind pressure and thermal buoyancy (the stack effect). The following is a summary of formulae for calculating interior airflow.

1.2.1 Flow Due to Wind--Single Opening. Factors affecting ventilation wind forces include average velocity, prevailing direction, seasonal and daily variation in velocity and direction, and local obstructions such as nearby buildings, hills, trees, and shrubbery. For a space with only a single opening, use Equation 8.

MIL-HDBK-1011/2
APPENDIX C (continued)

EQUATION:
$$Q = 0.02 CAV_{ref} \quad (8)$$

Where Q = the volumetric flow rate, cfm (m^3/sec)
 C = unit conversion factor, 88.0 for Q in cfm and 1.0 for Q in m^3/sec
 A = the area of opening, ft^2 (m^2)
 V_{ref} = the mean velocity at a reference point in the free wind at a height equal to that of the building, mph (m/sec).

1.2.1.1 Estimating Quantity of Inlet Air. The quantity of air forced through ventilation inlet openings, assuming inlet and outlet areas are equal, can be estimated by the Equation (9).

EQUATION:
$$Q = CKAV \quad (9)$$

where Q = airflow, cfm (m^3/sec)
 C = unit conversion factor, 88.0 for Q in cfm and 1.0 for Q in m^3/sec
 K = effectiveness of openings, 0.50 to 0.60 for perpendicular winds and 0.25 to 0.35 for diagonal winds
 A = free area of inlet openings, ft^2 (m^2)
 V = mean external wind velocity, mph (m/sec)

Equation 9 does not take into account the air damming action of the wall. For a more precise estimation of airflow due to wind which does not require wind tunnel testing for each building, but uses discharge and pressure coefficient data from previous wind tunnel tests, use Equation 10.

EQUATION:
$$Q = C_d^A [(C_{p1} - C_{p2}) * V_{ref}^2]^{1/2} \quad (10)$$

where Q = volumetric flow rate
 C_d = discharge coefficient, commonly 0.65, appropriate for small openings near the center of walls.

When openings are near the edge of a wall in the downwind space, the discharge coefficients increase to 0.7 and 0.8, with larger values for bigger openings (10-20 percent of the wall area.) For openings similar in size to the cross-section of the downstream space, discharge coefficients of 0.8 to 0.9 are possible.

A = area of opening
 C_{p1} = windward pressure coefficient
 C_{p2} = leeward pressure coefficient
 V_{ref} = velocity at reference height (pressure coefficient measurement)

MIL-HDBK-1011/2
APPENDIX C (continued)

1.2.2 Flow Due to Wind--Openings in Series

1.2.2.1 Flow Volume. To calculate volume of flow for openings in series use Equation 11.

$$\text{EQUATION: } Q = \frac{[(C_{p1} - C_{p2} + 1) V_{\text{ref}}]}{[1/(C_{d1}^2 A_1^2) + 1/(C_{d2}^2 A_2^2) + \dots + 1/(C_{dn}^2 A_n^2)]}^{1/2} \quad (11)$$

where

- C_{p1} = pressure coefficient near most windward opening
- C_{d1} = discharge coefficient near most windward opening
- C_{p2} = pressure coefficient near next most windward opening
- C_{d2} = discharge coefficient near next most windward opening
- A_1 = area of most windward opening
- A_2 = area of next most windward opening
- V_{ref} = wind velocity at reference height at which pressure coefficients were taken.

1.2.2.2 Flow Velocity. To determine the mean flow velocity near the openings, use Equation 12.

$$\text{EQUATION: } V_o = Q / \text{effective area of opening} = Q / A_n \cos \alpha \quad (12)$$

where

- V_o = mean flow velocity near the opening, ft/min (m/sec)
- Q = volumetric flow rate (from Equation 8), cfm (m³/sec)
- A_n = area of opening, ft² (m²)
- α = angle of incidence of the wind

1.2.2.3 Discharge Coefficient for Varying Wind Angles. The discharge coefficient for varying wind angles is given by Equation 13.

$$\text{EQUATION: } C_d = C_a (\text{perpendicular winds}) \cos \alpha \quad (13)$$

1.2.3 Flow due to thermal forces. If there is no significant internal resistance due to a partitioned interior, and assuming indoor and outdoor temperatures are close to 80deg.F (26.7deg.C) and inlet and outlet openings are equal, the flow due to stack effect is given by Equation 14.

$$\text{EQUATION: } Q = CKA [g \Delta h (t_i - t_o) / t_i]^{1/2} \quad (14)$$

where

- Q = airflow, cfm (m³/sec)
- C = unit conversion factor, 60.0 for Q in cfm and 1.0 for Q in m³/sec
- K = discharge coefficient for the openings, 0.65 for multiple openings and 0.40 for single opening in a room
- A = free area of inlets, ft² (m²)
- g = gravitational constant, 32.2 ft/sec² and 9.81 m/sec²
- Δh = height from bottom to top of opening for rooms with

MIL-HDBK-1011/2
APPENDIX C (continued)

single openings, and average height difference
between bottom of the inlets and top of the outlets
for rooms with multiple openings, ft (m)
 t_i = average indoor air temperature, degrees F (degrees C)
 t_o = temperature of outdoor air, degrees F (degrees C)

For further discussion, see DM-3.03.

1.2.4 Combining Terms. As a rough rule of thumb, when flow due to the stack effect and flow due to winds are equal, the actual combined flow is 30 percent greater than the flow caused by either force alone.

1.3 Wind Tunnel Testing. Wind tunnels are used to determine the airflow rates through interior spaces of buildings for each relevant wind direction. The airflow rates are expressed as ratios of interior velocity over a "reference velocity" obtained from historical climatological records. When combined with the climate's probability distributions of wind speed, wind direction, temperature, and humidity, the acceptability of natural ventilation can be determined. This is discussed in the Climate Analysis Method, Appendix B. In certain cases, the wind tunnel will be used to produce mean pressure distributions, as functions of a reference wind speed and direction. For such cases, the mean airflow rates through interior spaces of the building are computed analytically rather than being obtained experimentally.

Presented in this section are the minimum requirements for wind tunnel facilities, instrumentation, and wind tunnel testing procedures to ensure the acceptability of the obtained airflow rates or pressures.

1.3.1 Wind Tunnel Test Facilities. Because the objectives of wind tunnel testing for natural ventilation studies are mean airflow rates or mean pressure distributions, the turbulence characteristics of the atmospheric boundary layer need not be fully modeled. The principal requirement is that the mean velocity profile, expected at the building site, be modeled accurately in the wind tunnel. An appropriate set of target mean velocity profiles are given by the logarithmic law (Equation 15):

$$\text{EQUATION: } U(z) = 2.5 u * \ln(z/z_o) \quad (14)$$

where $U(z)$ = mean velocity at elevation z above grade, ft(m/sec),
 u = the shear velocity, mph (m/sec)
 z_o = the roughness length, a measure of surface roughness,
ft (m).

Appropriate values of roughness lengths for various terrain categories are given in Table C-6.

1.3.1.1 Variations from Theoretical Mean. If experimentally obtained mean velocities from the theoretical target mean velocity profile is less than 0.10, then the mean velocity profile is assumed to be modeled acceptably. A presentation of the experimentally obtained mean velocity profile (or profiles) must be included in the documentation of the wind tunnel testing.

MIL-HDBK-1011/2
 APPENDIX C (continued)

Table C-6
 Typical Terrain Categories and Roughness Lengths

| Terrain Category | Definition | Roughness Length (m) |
|------------------|---|----------------------|
| I | Open water | 0.005 |
| II | Open terrain | 0.07 |
| III | Suburbs at considerable distance from towns, sparse development with hedges and trees | 0.30 |
| IV | Towns, densely built-up suburbs, wooded terrain | 1.00 |
| V | Centers of large cities | 2.50 |

1.3.1.2 Profile Limitations. It is not necessary to model the entire mean velocity profile through the atmospheric boundary layer up to the gradient height (the height above which effects of the earth's surface roughness are no longer felt), but only the portion two times the height of the building and its nearby surroundings.

Since the turbulent structure of the atmospheric boundary layer need not be modeled accurately, there is no requirement for a minimum wind tunnel air speed (or minimum wind tunnel Reynolds number). There are, however, minimum wind speed requirements for airflow rates through models. Refer to para. 1.3.2.3 of this Appendix.

1.3.2 Wind Tunnel Models. Discussed in this subsection are the minimum requirements for models used in the wind tunnel tests.

1.3.2.1 Model Detail. The model and full-scale building must be geometrically similar. All significant detail and relief must also be modeled. This requires a certain feel for the problem to determine what is and what is not significant detail. A 1-in. (25.4 mm) deep relief at full-scale may not have any effect on natural ventilation, but a 4-in. (101.5 mm) deep relief may. On the other hand, in certain pockets where flow is minimal, a 1-ft (0.3 m) deep relief may not be significant. If a detail is estimated to have a significant effect upon the pressure loss through a building (such as an insect screen), it should be included in the model. If a detail might affect the flow in or out of an opening, it should be included in the model. If the person conducting the experiment has little feel for what is and what is not needed, err on the side of excessive detailing. A model cannot have too much detail, but can have too little.

MIL-HDBK-1011/2
APPENDIX C (continued)

Since airflow rates through interior spaces of buildings are to be studied, interior furnishings having significant blockage should be modeled. Furnishings having significant blockage include easy chairs, sofas, bookshelves, desks, beds, cabinets, dressers, bathroom fixtures and kitchen fixtures. Items such as lamps, tables, and dining room chairs most likely would not have to be modeled.

1.3.2.2 Immediate Surroundings. It is important to model all nearby buildings and structures, expected foliage, and variations in terrain that exceed a few feet in height. With low-rise buildings it is typical to model all such features within a radius of five times the height of the subject building, and the rough massing of significant building and obstructions beyond that for a minimum of 500 feet (150 m) for any upwind direction tested. For buildings above 4 stories, the radius within which detailed modeling is needed can be reduced. The aerodynamic effects of features beyond this minimum are modeled by the mean velocity profile selected.

Trees are also modeled with overscaled pores and foliage elements, usually made of screening or furnace air filter material.

1.3.2.3 Model Size and Wind Tunnel Speed. The minimum model size and reference wind tunnel speed are governed by a set of minimum Reynolds number requirements. The Reynolds number is a measure of the ratio of inertial to viscous forces. Model dimensions and velocities are usually less than full-scale values, however model viscosity typically equals full-scale viscosity (if air is the testing fluid). Therefore, relatively speaking, airflow through models is much more viscous than it is through the full-scale building. In nearly all full-scale building flows, the flow patterns and pressure losses are dominated by inertial rather than viscous effects. Air flow rates in the model of such a building must therefore be sufficiently great that the flow is dominated by inertial effects. This is guaranteed by maintaining an appropriate minimum Reynolds numbers for each of the flow situations in the model.

1.3.2.4 Reynolds Number for Flow Around Bluff Bodies. The Reynolds number for flow around bluff bodies such as building exteriors, RB, shall be greater than 20,000.

EQUATION:
$$R_B = L_B U_B / \nu \quad (16)$$

where L_B is the typical building dimension (m),
 U_B is the typical approach velocity (m/sec),
 ν is the kinematic viscosity of the air (1.7×10^{-5} m²/sec)

1.3.2.5 Reynolds Number for Flow Through Window Openings. The Reynolds number for flow through window openings, RW, shall be greater than 300.

EQUATION:
$$R_W = L_W U_W / \nu \quad (17)$$

where L_W is the minimum window dimension (m), and
 U_W is the mean velocity through the window (m/sec).

MIL-HDBK-1011/2
APPENDIX C (continued)

1.3.2.6 Reynolds Number for Flow through Ductways. The Reynolds number for flow through a long rough duct such as a long hall or corridor, R_D , shall be greater than 2,000.

EQUATION:
$$R_D = L_D U_D / \nu \quad (18)$$

where L_D is the minimum cross-sectional dimension of the duct (m), and U_D is the mean velocity through the duct (m/sec).

1.3.2.7 Reynolds Number for Flow in a Room. The Reynolds number for flow in a room, R_R , shall be greater than 20,000.

EQUATION:
$$R_R = L_R U_R / \nu \quad (19)$$

where L_R is the minimum interior room dimension (m), and U_R is the maximum air speed in the room, usually equal to U_w .

1.3.2.8 Reynolds Number for Flow Through Screens and Louvers. The Reynolds number of the flow through modeled and geometrically similar screens and louvers will never meet the minimum criteria given above. Therefore, full size insect screens are typically used on models; and louvers are typically modeled to a larger scale than the building so that the minimum louver separation is 0.15 in (4 mm). In both cases, the opening dimensions are still small relative to building dimensions, so model/full-scale flow patterns will still be similar. Pressure loss coefficients through rooms, windows, halls, doors are assumed to be equal for model and full-scale (if minimum Reynolds number requirements are met). Use of full-scale insect screens and oversized louvers ensures that the respective model and full-scale pressure loss coefficients are equal.

1.3.2.9 Reynolds Numbers--Reducing Margin of Error. Satisfying the above minimum Reynolds number requirements does not guarantee Reynolds number independent results but errors will be minimized. It is good practice to use models that are as large as possible, limited by the wind tunnel dimensions, and to use wind velocities as great as possible, limited only by the wind tunnel capacity.

1.3.2.10 Model Size Limitations. Model size is limited by the boundary layer size and wind tunnel size. As mentioned earlier, the boundary layer need not be modeled to its gradient height, but need only be modeled to a height that fully engulfs the modeled building in question and all the nearby buildings. The thickness of the boundary layer should be at least 200 percent of the highest building modeled. If the models are bulky, they may be further restricted in size by a minimum wind tunnel blockage requirement. The projected frontal area of all buildings modeled should never exceed 10 percent of the wind tunnel cross-sectional area.

The Reynolds number restrictions on model size often conflict with the model height limit, the blockage requirement, and the requirement that a significant area around the building be modeled, particularly if the building

MIL-HDBK-1011/2
APPENDIX C (continued)

in question is a highrise building. For such cases when a definite conflict exists, two or more models are required. The first is a small-scale solid model (without openings) of the building in question including all features of the surrounding area that need to be modeled. The second and additional models are large-scale models of the interior spaces to be naturally ventilated. The latter models should be large enough so that all Reynolds number constraints are satisfied, and should experience approach flows and pressure differentials similar to those observed on the small scale model.

1.3.3 Instrumentation. The instrumentation must be able to measure mean air velocities with accuracy (+2 percent is common) over the range of velocities expected for the wind tunnel being used. Omnidirectional, temperature-compensated thermistor-type air speed probes are sensitive, reasonably durable, and relatively inexpensive. Their frequency response is damped, but is usually adequate for ventilation studies. Probe diameters of 1/4-inch (6 mm) or less are readily available, permitting easy airflow measurements within interior spaces of the building of the model. (Holes can be drilled in walls, floors, and ceilings to permit the insertion of the probe, and can be taped closed when not in use.)

1.3.3.1 Velocity Measurements. For certain studies, when wind directions are known, Pitot-static tubes may be used to measure mean velocities. The Pitot-static tube may be attached to a pressure transducer or a manometer. Air speeds must be relatively high if a Pitot-static tube (or other pressure variant) is used. For whichever velocity instrumentation is used, the accuracy of the system over the range of velocities encountered in the study should be documented.

1.3.3.2 Pressure Measurements. When mean pressure measurements are required, they may be measured with pressure taps and any of the pressure transducers typically accepted for the measurement of pressures for the design of glass and cladding in buildings. Such a transducer has a frequency response in excess of the needs for natural ventilation studies. Since mean pressures are desired, lower-cost manometers may be substituted. Extremely low differential pressures may be measured accurately with an alcohol-filled manometer read with a measuring microscope.

1.3.4 Wind Tunnel Test Procedures. The ratios of interior airflow to exterior wind should be determined for each critical wind direction. A critical wind direction is one that occurs a significant proportion of the time (over 5 percent of the time during the period that ventilation is required). Two procedures are suggested to obtain interior airflow ratios.

1.3.4.1 Procedure 1--Direct Velocity Measurement. In the first procedure, interior airflow velocities are measured directly. This method is applicable for those cases when the model is sufficiently large so that all pertinent Reynolds number requirements are satisfied, and the model is sufficiently small so that all significant nearby features can be modeled within the wind tunnel test section. A wind tunnel mean free stream reference wind velocity is obtained for each critical wind direction (usually, weather stations record wind speeds from eight, and sometimes sixteen, directions).

Reference mean wind velocities traditionally are taken at an elevation of 33 ft (10 m) above grade. A reference wind velocity at any

MIL-HDBK-1011/2
APPENDIX C (continued)

location or at any elevation is appropriate as long as it is well defined. Mean interior airflow velocities are measured throughout the interior spaces to be naturally ventilated. If the entire three dimensional flow field is to be determined in the interior spaces, then a sufficient number of point measurements must be recorded to define that flow field.

Often, however, air exchange rates are desired. To measure an air exchange rate, only the airflow rates into, or out of, a confined space need be measured. When the inlet, or outlet, consists of a single opening, the airflow rate may be determined from a single measurement, and is equal to:

$$\text{EQUATION:} \quad Q = U_w A C \quad (20)$$

where U_w is the mean air velocity at the opening center (m/sec),
 A is the area of the opening (m^2), and
 C is a coefficient, 0.8 to 0.9, determined experimentally or theoretically for a set of similar openings to account for the nonuniform mean velocity distribution over the opening dimensions.

For either case, the interior wind speed velocities, U_i , are given in terms of the dimensionless velocity ratio:

$$\text{EQUATION:} \quad C_i = V_i / U_{ref} \quad (21)$$

where U_{ref} is the reference velocity.

1.3.4.2 Procedure 2--Indirect Velocity Measurement. The second procedure applies when a small scale model is to be used in conjunction with a large scale model of the interior spaces. For each critical wind direction a reference wind tunnel mean free stream velocity is measured on the small-scale solid model. In addition, a mean pressure differential from the inlet to outlet location is measured for each interior space under consideration.

The large-scale models of the interior spaces are then used to determine interior airflow rates for a given pressure differential across the large-scale model. The large-scale model is placed within the wind tunnel, the openings are blocked, and the mean pressure differential is measured across the model from the assumed inlet and outlet. The openings are then opened, and the airflow rates, and/or three dimensional flow field are measured as before. Interior air speeds for the small-scale model, U_{ns} , are then computed in the following manner.

Across each interior space on the small scale model the total pressure differential is given by:

$$\text{EQUATION:} \quad \Delta P_{ns} = (1/2 \rho U_{ns}^2) C_{pn} \quad (22)$$

where C_{pn} is a total pressure coefficient.

MIL-HDBK-1011/2
APPENDIX C (continued)

Similarly for the large-scale model:

$$\text{EQUATION:} \quad \Delta P_{nl} = (1/2 \rho U_{nl}^2) C_{pn} \quad (23)$$

The total pressure coefficient measured on the large-scale model is assumed to equal that on the small-scale model, and that on the full-scale building. The interior wind velocities on the large-scale model U_{nl} have been measured, as well as the pressure differentials, WP_n and WP_{nl} . Dividing one equation by the other leads to:

$$\text{EQUATION:} \quad U_{ns} = (\Delta P_{ns} / \Delta P_{nl})^{1/2} U_{nl} \quad (24)$$

Interior air velocity ratios (the final answers) are then obtained as:

$$\text{EQUATION:} \quad C_{vn} = U_{ns} / U_{ref} \quad (25)$$

where U_{ns} is the interior air velocity of the small-scale model for the direction n , and
 C_{vn} is the ratio of interior air velocity to a reference mean free-stream velocity.

1.3.4.3 Procedure for High-Rise Buildings. The second procedure is particularly appropriate for the determination of interior airflow rates in highrise buildings composed of typical floors, or typical living units. This method may become cumbersome when many different interior space models are required for a single building. An alternative method has been suggested by Vickery (1981) to streamline the determination of airflow rates in highrise buildings with many different interior spaces.

Starting with mean pressure distributions obtained from a small-scale model, interior airflow rates are computed analytically. Each interior space is in essence a closed conduit. Basic laws of closed-conduit flow can be used to determine airflow rates through each space, given the pressure differential across the conduit, and the pressure loss coefficients through halls, through openings, and around corners. A number of such computer models have been developed. Refer to paras. 2.3 to 2.3.3 of this Appendix.

1.3.5 Use of Wind Tunnel Air Flow Rates. The airflow rates obtained from wind tunnel tests alone do not determine whether or not a building can be naturally ventilated. Interior airflow rates must be combined with other information, particularly probability distributions of directional reference velocities, temperature, humidity, and solar radiation, in order to determine the appropriateness of naturally ventilating a space. See Appendices B and C, para 1.1 for the minimum climatic considerations.

1.4 Field Modeling. Researchers at the Florida Solar Energy Center (FSEC) have proposed testing small scale models outdoors in the natural wind to observe airflow through naturally ventilated buildings. Their limited testing (Chandra et al., 1983) shows excellent correlation between a one-story building and a model tested in this manner on the actual building site.

MIL-HDBK-1011/2
APPENDIX C (continued)

Although this method has not gone through rigorous testing to date, it may provide an alternative to wind tunnel testing for small scale buildings.

1.4.1 Model Requirements. The model, supported by a plywood base the same size as the building's footprint, is mounted on a threaded flange fitted on a threaded pipe. It can then be freely rotated for various wind incidences. A wind vane is attached above the model to indicate relative wind direction. The model can be built out of plexiglass for ease in viewing during testing, although solar heating must be avoided. Aluminum foil on the roof is recommended for this. A scale of 1 : 24 is recommended. The model must be mounted and tested so that the height of the windows in the model is the same as the height of the windows of the proposed building at full scale.

1.4.2 Applicable Buildings. There is no simulation of the ground plane nor any match of the approach flow roughness length to the model height as in wind tunnel testing. Instead, the model encounters a uniform vertical velocity gradient with turbulent flow. The fluctuations of velocity and flow direction give a useful if qualitative assessment of the ventilation in the building. This type of testing is limited to residential scale buildings and is not recommended for buildings taller than one story. In taller buildings this type of testing will overestimate the effects of surrounding objects since the surroundings are not matched to model height.

1.4.3 Types of Tests. There are several possible approaches:

- a) Smoke can be introduced into the model for flow visualization (as is commonly done in wind tunnel testing).
- b) A laser can be used with a glass rod to produce a planar light source. The flow of smoke along a single plane may then be observed and recorded with a low light level video camera. This must be done at night.
- c) An omnidirectional temperature-compensated thermistor-type airspeed probe can be used to measure interior velocities. Cloudy-sky conditions are recommended to minimize radiation errors.

For examples of these, refer to Chandra et al. (1983), pp. 45-53.

MIL-HDBK-1011/2
APPENDIX C (continued)

PAGE 124 INTENTIONALLY LEFT BLANK

MIL-HDBK-1011/2
APPENDIX C (continued)

Section 2: INTERIOR TEMPERATURES

2.1 Purpose

2.1.1 Internal Gain and Interior Temperature Rise. The ventilation method and overlay in Appendix B assumes that internal gains from sun, lights, appliances, and occupants are not high enough to increase the interior temperature. This is usually an appropriate assumption for residential and light commercial applications with effective sun control and roof insulation.

If internal gains are likely to be large (as in high-rise office buildings), then it will be necessary to determine the rise in interior temperature resulting from these high internal gains. The rise in temperature will be a function of the rate of internal gains and the rate of heat removal. The primary route of heat removal for this strategy will be by ventilation, although conduction through parts of the building envelope may play a role.

2.2 Equations

2.2.1 Temperature Rise. The temperature rise can be estimated based on the following relationship, which holds when averaged over time:

$$\text{EQUATION:} \quad \text{heat loss by ventilation} = \text{internal heat gain} \quad (26)$$

or:

$$\text{EQUATION:} \quad (\text{ACH}) (\text{Thermal Mass of Air}) (\text{Bldg. Vol}) (\Delta T) = Q_{\text{+internal}}, \quad (27)$$

where ACH = air changes per hour
 Thermal Mass of Air = 0.018 Btu/lb/deg.F
 Bldg Vol = Building Volume in ft.³
 ΔT = temperature difference in deg.F
 $Q_{\text{+internal}}$ = $Q_{\text{+occupants}}$ + lights + appliances + solar

Rearranging and restating:

$$\text{EQUATION:} \quad \Delta T = Q_{\text{+internal}} / (\text{ACH}) (0.018) (\text{Bldg Vol}) \quad (28)$$

2.2.2 Ventilation Boundary Adjustment. In the ventilation design procedure in Section 2, the ventilation strategy boundaries are compared to climate data on the psychrometric summary chart. These boundaries can now be adjusted to account for the higher temperatures indoors. The boundary can be moved to lower temperatures to represent the outdoor conditions under which the hotter interior temperatures lie along the ventilation strategy boundaries.

$$\text{EQUATION:} \quad \text{The new outdoor } T_{\text{+boundary}} = \text{original } T_{\text{+boundary}} - \Delta T \quad (29)$$

Therefore if ΔT is subtracted from the $T_{\text{+boundary}}$, at the 0.5 or 1.0 m/sec boundary on the original overlay, the additional percentage of time

MIL-HDBK-1011/2
APPENDIX C (continued)

that comfort is exceeded can be rapidly determined on the annual psychrometric summary by counting the percentage of time between the original boundary and the new interior temperature line. If the total percentage of time exceeds the acceptable percentage, either Q_{internal} should be reduced or Q_{vent} should be increased.

Thus, to determine the required air changes per hour to keep the interior temperature below the top of the comfort zone at the 0.5 m/sec boundary, solve for ACH.

$$\text{EQUATION:} \quad \text{ACH} = (Q_{\text{internal}}) / (0.018) (\text{Bldg Vol.}) (\text{delta T}) \quad (30)$$

where Q_{internal} is an assumed (estimated or calculated) value,
Bldg Vol is known (from the preliminary design), and
 $\text{delta T} = T_{\text{out}} - T_{\text{Top of 0.5 m/sec boundary}}$

2.3 Computer Models of Interior Temperatures. The use of a computer allows a much more detailed analysis of the interior environment of buildings. Currently available computer programs for thermal analysis include: DOE-2, BLAST, CALPAS3 and TRACE. These can perform hour-by-hour analysis of the detailed loads imposed on the building by weather, occupancy, lighting, equipment, and the shape and thermal properties of the building envelope.

The mechanical engineer should evaluate the expected internal loads and determine whether they cause the comfort zone to be substantially exceeded. If so, he should consider computer simulation for more precise evaluation. Computer modeling programs and information sources are listed below.

2.3.1 Program Inputs and Outputs. Program inputs include a detailed description of the physical parameters of the building, its expected occupancy, and an appropriate weather tape. Outputs include expected temperatures and humidities on an hourly basis and as summaries.

2.3.2 Program Limitations. To date, such programs do not predict the airflow patterns or velocities within buildings. They are generally unable to predict even the bulk ventilation rate through spaces caused by wind pressures. They also do not model the detailed radiation characteristics of the interior. These limitations severely affect the utility of such models for design of naturally ventilated buildings.

2.3.3 Computer Programs for Thermal Analysis. Currently available computer programs and information sources are listed below.

DOE 2: National Technical Information Service (NTIS)
U.S. Department of Commerce
5285 Port Royal Road
Springfield, Virginia 22161

MIL-HDBK-1011/2
APPENDIX C (continued)

BLAST: U.S. Army Construction Engineering Research Lab (CERL)
P.O. Box 4005
Champaign, Illinois 61820

CALPAS3: Berkeley Solar Group
3140 Martin Luther King Jr. Way
Berkeley, California 94703

TRACE: Trane Air Conditioning Corporation
3600 Pammel Creek Road
La Crosse, Wisconsin 54601

MIL-HDBK-1011/2
APPENDIX C (continued)

PAGE 128 INTENTIONALLY LEFT BLANK

MIL-HDBK-1011/2
APPENDIX C (continued)

Section 3: OCCUPANT COMFORT

3.1 The Bioclimatic Chart. The bioclimatic chart, (see Figure 4), can be used to determine whether comfort will be achieved at a given time when the interior air velocity, air temperature, and humidity levels are known. The procedure for determining comfort using the bioclimatic chart is the same as that described in Appendix A, para. 1.4, except that expected interior conditions rather than the exterior climatic conditions are plotted. The effects of the building envelope and the internal gains due to people, lights, equipment, and solar gain are factored into the expected interior temperature and humidity levels based on the daily average, monthly average, specific hour of the day, or other long-term climate data (see Appendix C, para. 2.2). If the plotted point falls at or below the expected interior air velocity, then comfort can be expected for that space under the specified conditions.

3.2 The J.B. Pierce Human Thermoregulatory System Model. The J.B. Pierce two-node mathematical model of the human thermoregulatory system is the most appropriate computer model for predicting human comfort under natural ventilation conditions. The model is a "rational" index, derived in a logical manner from established principles of heat transfer physics. It describes through empirical equations the effects of the body's thermoregulatory controls. (Refer also Appendix A, Section 1.)

The model has been tested against human experiments and found to be effective at conditions near the comfort zone with subjects under low to moderate activity. It may underestimate convective (air movement) heat loss at higher wind velocities because it does not differentiate between clothed and exposed skin areas of the body.

The model is of the body only, requiring manual input of climatic conditions. To use it to predict percentages of time that a building will be comfortable, the designer must modify it to read hourly weather data files or the hourly output of a thermal loads program.

MIL-HDBK-1011/2
APPENDIX C (continued)

PAGE 130 INTENTIONALLY LEFT BLANK

MIL-HDBK-1011/2
APPENDIX C (continued)

Section 4: WHOLE-HOUSE FAN SIZING PROCEDURE

4.1 Assumptions. Whole-house fans should be sized by assuming that 30 to 60 air changes per hour (about 0.5 to 1.0 per minute) are to be provided to the building depending on the severity of the climate.

4.2 Minimum Required Airflow, CFM. Calculate the minimum required cfm using Equation 31.

EQUATION: $CFM = 0.5 \times \text{building volume}$ (31)

where: $\text{volume} = \text{ft}^2 * \text{ceiling height}$

4.3 Fan Selection. Select a whole-house fan which has a cfm rating equal to or greater than that calculated above. Note that this should be the whole-house fan cfm rating at 0.1-inch water static pressure (SP) drop and not the free air cfm without any pressure drop. If the cfm rating does not state the pressure drop, assume it is for free air. For fan selection, derate the free air cfm by 25 percent to get the 0.1-inch SP rating.

MIL-HDBK-1011/2
APPENDIX C (continued)

PAGE 132 INTENTIONALLY LEFT BLANK

MIL-HDBK-1011/2

APPENDIX D

WORKED EXAMPLE OF THE CLIMATE ANALYSIS AND WINDOW SIZING PROCEDURE

MIL-HDBK-1011/2
APPENDIX D (continued)

PAGE 134 INTENTIONALLY LEFT BLANK

MIL-HDBK-1011/2
APPENDIX D (continued)

CONTENTS

| | | | |
|---------|-------|---|-----|
| Section | 1 | BUILDING IN HOT HUMID ENVIRONMENT, OAHU, HAWAII | 137 |
| | 1.1 | Purpose | 137 |
| | 1.2 | The Example Project | 137 |
| | 1.3 | Climate Analysis | 137 |
| | 1.3.1 | Results of the Climate Analysis | 146 |
| | 1.4 | Window Sizing Procedure | 146 |
| | 1.4.1 | Results of the Window Sizing Procedure | 148 |

FIGURES

| | | | |
|--------|------|---|-----|
| Figure | D-1 | Site Plan of Kaneohe Bay Marine Corps Air Station . . . | 137 |
| | D-2 | Plans of Building #1031 | 138 |
| | D-3 | Elevations of Building #1031 | 138 |
| | D-4 | Cross-Section of Building #1031 | 139 |
| | D-5 | Typical Room Plan of Building #1301 | 139 |
| | D-6 | Psychrometric Summary/Month All | 140 |
| | D-7 | Psychrometric Summary/Month Jan | 141 |
| | D-8 | Psychrometric Summary/Month Jan | 142 |
| | D-9 | Surface Winds/Month Aug | 143 |
| | D-10 | Surface Winds/Month Sep | 144 |
| | D-11 | Climate Analysis Summary Worksheet | 145 |

MIL-HDBK-1011/2
APPENDIX D (continued)

PAGE 136 INTENTIONALLY LEFT BLANK

MIL-HDBK-1011/2
APPENDIX D (continued)

Section 1: BUILDING IN HOT HUMID ENVIRONMENT, OAHU, HAWAII

1.1 Purpose. This Appendix contains a worked example of the climate analysis. presented in Appendix B and the window sizing procedure presented in Appendix C, para. 1.1. Its intent is to present the data necessary for using this handbook and to provide a simple example to follow.

1.2 The Example Project. The building used for this example is a barracks (Building #1031) at the Marine Corps Air Station at Kaneohe Bay on Oahu, Hawaii. It is an existing two-story building in the middle of a complex of two three-story barracks buildings. Figures D-1 through D-5 show plans, elevations, a cross section, and typical room plans of the barracks.

1.3 Climate Analysis. Figures D-6 through D-8 present examples of the SMOS Psychrometric Summaries and Figures D-9 through D-10 present surface wind data. These data were obtained from the National Climatic Center and used to perform the Climate Analysis.

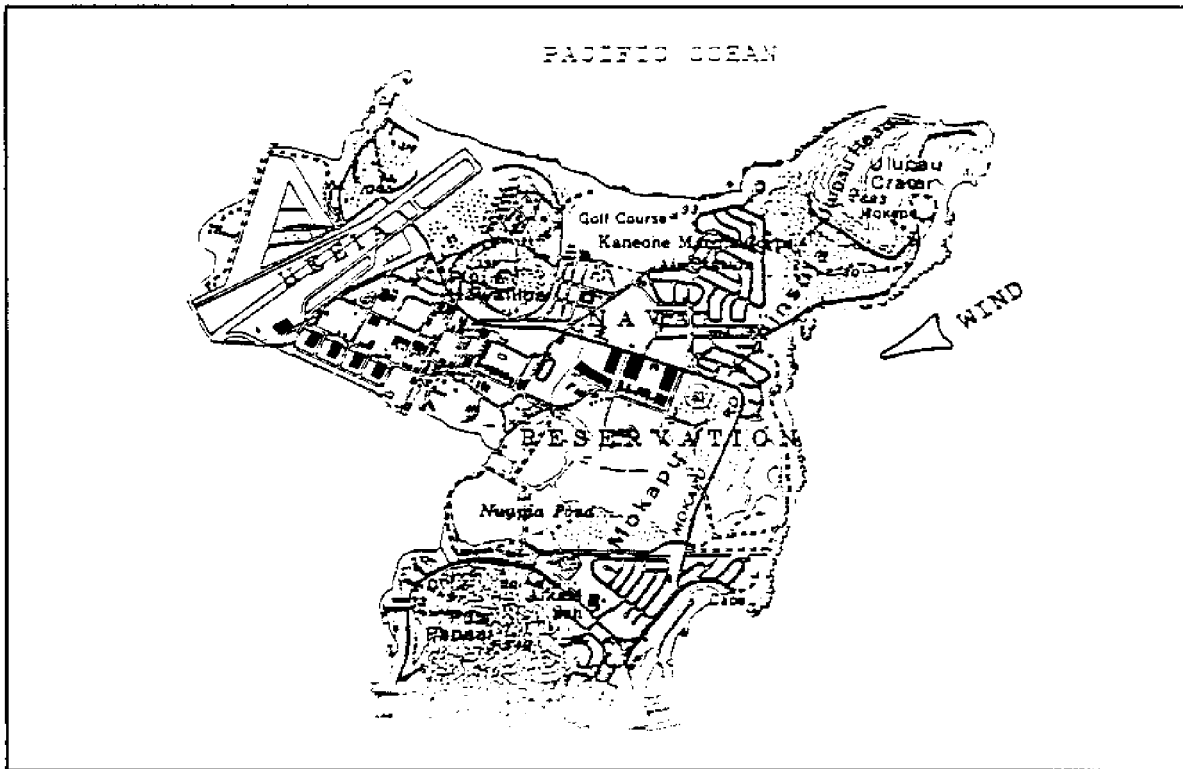

Figure D-1
Site Plan of Kaneohe Bay Marine Corps Air Station

MIL-HDBK-1011/2
APPENDIX D (continued)

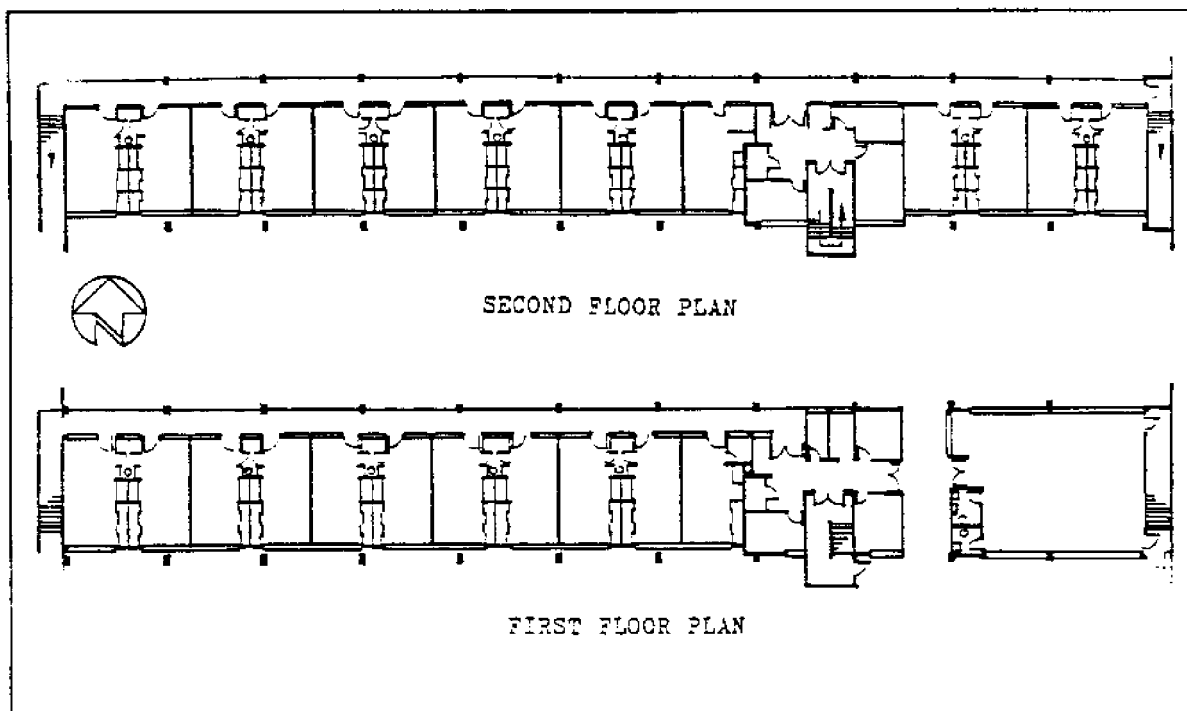

Figure D-2
Plans of Building #1031

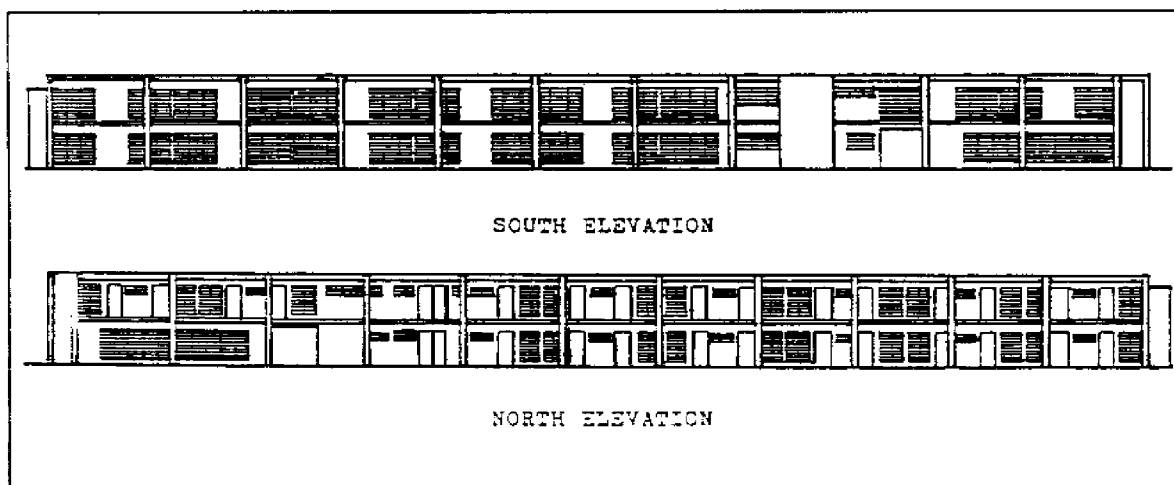

Figure D-3
Elevations of Building #1031

MIL-HDBK-1011/2
APPENDIX D (continued)

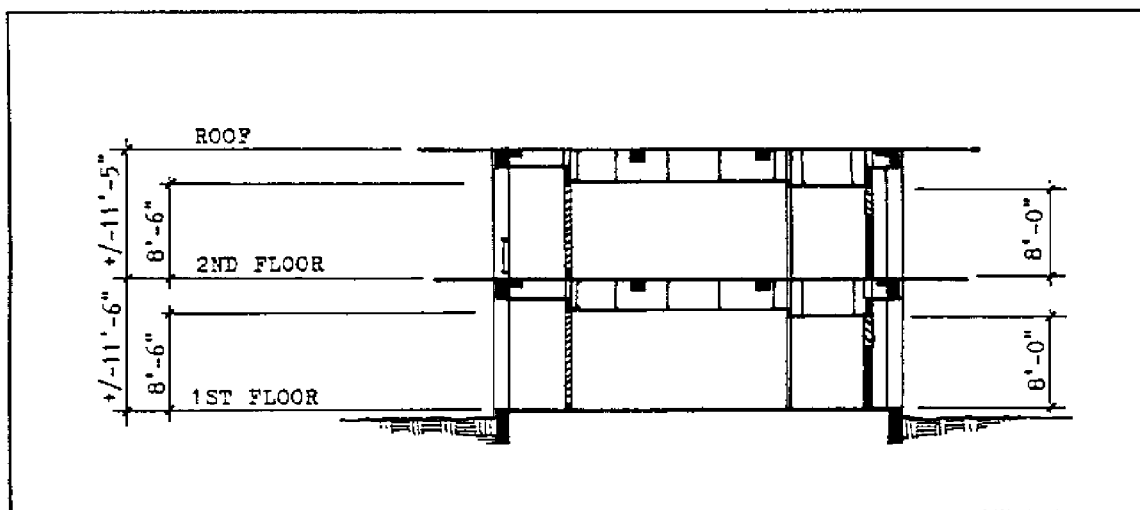

Figure D-4
Cross-Section of Building #1031

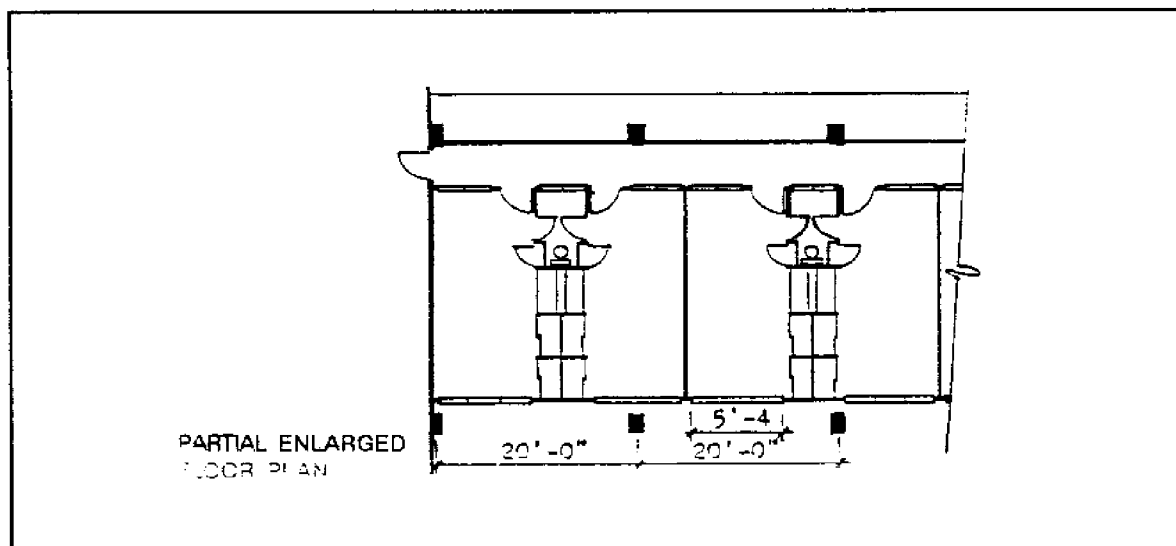

Figure D-5
Typical Room Plan of Building #1301

MIL-HDBK-1011/2
APPENDIX D (continued)

PSYCHROMETRIC SUMMARY

| Temp (F) | WET BULB TEMPERATURE DEPRESSION (F) | | | | | | | | | | | TOTAL | | | Total | | | | | |
|----------|-------------------------------------|-----|------|------|------|------|-------|-------|-------|-------|-------|-------|-------|-------|-------|-------|------|----------|----------|-----------|
| | 0 | 1-2 | 3-4 | 5-6 | 7-8 | 8-10 | 11-12 | 13-14 | 15-16 | 17-18 | 19-20 | 21-22 | 23-24 | 25-26 | 27-28 | 29-30 | 31 | Dry Bulb | Wet Bulb | Dew Point |
| | | | | | | | | | | | | | | | | | | | | |
| 88/85 | | | | | 2 | 5 | 3 | | 0 | | | | | | | | 2 | 11 | | |
| 84/83 | | | | | 2 | 2 | | | | | | | | | | | 61 | 158 | | |
| 82/81 | | | | 9 | 22 | 15 | 3 | 2 | 0 | | | | | | | | 224 | 267 | 2 | |
| 80/79 | | | 3 | 40 | 50 | 39 | 8 | | | | | | | | | | 382 | 382 | 171 | |
| 78/77 | | | 3 | 18 | 58 | 61 | 25 | 1 | 0 | | | | | | | | 124 | 301 | 117 | |
| 76/75 | | | 19 | 59 | 112 | 38 | 7 | | | | | | | | | | 19 | 420 | 280 | |
| 74/73 | .1 | 2.1 | 10.4 | 12.5 | 28 | | | | | | | | | | | | 1 | 222 | 537 | |
| 72/71 | | 2.8 | 4.1 | 32 | 9 | | | | | | | | | | | | 56 | 225 | 146 | |
| 70/69 | 2 | 6 | 8 | .1 | | | | | | | | | | | | | 55 | 146 | 9 | |
| 68/67 | | | | | | | | | | | | | | | | | 1198 | 1198 | 1198 | |
| 66/65 | | | | | | | | | | | | | | | | | | | | |
| 64/63 | | | | | | | | | | | | | | | | | | | | |
| 62/61 | | | | | | | | | | | | | | | | | | | | |
| 60/59 | | | | | | | | | | | | | | | | | | | | |
| TOTAL | 3 | 70 | 22.8 | 97.8 | 22.4 | 8.4 | 1.3 | 2 | 0 | | | | | | | | 1198 | 1198 | 1198 | |

| Element (%) | ΣX^2 | ΣX | \bar{X} | No. Obs. | Mean No. of Hours with Temperature | | | | |
|-------------|--------------|------------|-----------|----------|------------------------------------|-------------|-------------|-------------|-------------|
| | | | | | $\leq 0 F$ | $\leq 30 F$ | $\leq 67 F$ | $\leq 79 F$ | $\geq 80 F$ |
| Dry Bulb | 6971285 | 90845 | 75.8 | 1198 | 0 | 0 | 720.0 | 683.5 | 63.5 |
| Wet Bulb | 8684353 | 90787 | 75.7 | 1198 | 0 | 0 | 688.4 | 120.1 | 720.0 |
| Dew Point | 5906838 | 84119 | 70.2 | 1198 | 0 | 0 | 458.8 | 51.6 | 720.0 |

Figure D-8
Psychrometric Summary/Month Jan

SURFACE WINDS

NAVAL WEATHER SERVICE
DETACHMENT
ASHEVILLE, NC

PERCENTAGE FREQUENCY OF WIND
DIRECTION AND SPEED
(FROM HOURLY OBSERVATIONS)

22519 STATION KANEOHE BAY, HAWAII STATION NAME 73-77 YEARS MONTH AUG
ALL WEATHER CLASS ALL HOURS (U.S.T.)

MIL-HDBK-1011/2
APPENDIX D (continued)

CONDITION

| SPEED (KNOTS) DIR | 1-3 | 4-6 | 7-10 | 11-16 | 17-21 | 22-27 | 28-33 | 34-40 | 41-47 | 48-56 | > 56 | % | MEAN WIND SPEED |
|-------------------|-----|------|------|-------|-------|-------|-------|-------|-------|-------|------|-------|-----------------|
| N | 2 | 3 | 4 | | | | | | | | | 9 | 5.7 |
| NNE | .1 | 1.4 | 1.9 | | | | | | | | | 3.3 | 6.8 |
| NE | 8 | 4.0 | 8.4 | 2.7 | .1 | | | | | | | 16.9 | 8.1 |
| ENE | .6 | 4.8 | 19.0 | 16.8 | 7 | | | | | | | 43.9 | 10.3 |
| E | 5 | 4.3 | 15.9 | 8.8 | 2 | | | | | | | 29.6 | 9.3 |
| ESE | | 2 | 7 | 2 | | | | | | | | 1.0 | 6.4 |
| SE | | | .1 | .1 | .1 | | | | | | | 2 | 13.0 |
| SSE | | .1 | | | | | | | | | | .1 | 5.0 |
| S | 2 | .1 | .1 | | | | | | | | | 3 | 4.0 |
| SSW | 2 | .1 | | .1 | | | | | | | | 3 | 5.6 |
| SW | 2 | .1 | | | | | | | | | | 2 | 3.0 |
| WSW | 2 | .1 | | | | | | | | | | 2 | 3.3 |
| W | 2 | 2 | | | | | | | | | | 3 | 3.3 |
| WNW | | 2 | | | | | | | | | | 2 | 5.0 |
| NW | | | | | | | | | | | | | |
| NNW | .1 | 2 | | | | | | | | | | 3 | 5.8 |
| VARBL | | | | | | | | | | | | | |
| CALM | | | | | | | | | | | | 2.2 | |
| | 3.0 | 15.8 | 47.4 | 30.6 | 1.0 | | | | | | | 100.0 | 9.1 |

TOTAL NUMBER OF OBSERVATIONS 1240

Figure D-9
Surface Winds/Month Aug

MIL-HDBK-1011/2
APPENDIX D (continued)

SURFACE WINDS

PERCENTAGE FREQUENCY OF WIND
DIRECTION AND SPEED
(FROM HOURLY OBSERVATIONS)

NAVAL WEATHER SERVICE
DETACHMENT
ASHEVILLE, NC

22519 STATION KANEHOE BAY, HAWAII STATION NAME 73-77 YEARS SEP MONTH ALL
CLASS ALL WEATHER HOURS (L.S.T.)

CONDITION

| SPEED (KNOTS) DIR | 1-3 | 4-6 | 7-10 | 11-16 | 17-21 | 22-27 | 28-33 | 34-40 | 41-47 | 48-55 | % | MEAN WIND SPEED |
|-------------------|-----|------|------|-------|-------|-------|-------|-------|-------|-------|-------|-----------------|
| N | 4 | 1.1 | .8 | | | | | | | | 2.3 | 5.7 |
| NNE | 3 | 2.4 | 2.1 | 2 | | | | | | | 4.9 | 6.6 |
| NE | 5 | 4.4 | 6.2 | 2.2 | | | | | | | 13.8 | 7.9 |
| ENE | 8 | 5.1 | 17.9 | 11.7 | 7 | | | | | | 36.2 | 9.5 |
| E | 8 | 8.9 | 15.6 | 5.9 | .1 | | | | | | 28.7 | 8.4 |
| ESE | | .1 | 1.1 | .8 | | | | | | | 1.9 | 10.1 |
| SE | 2 | .1 | .3 | | | | | | | | .5 | 5.8 |
| SSE | 2 | | | | | | | | | | 2 | 2.0 |
| S | 7 | 3 | | | | | | | | | 1.0 | 2.8 |
| SSW | 6 | 5 | | | | | | | | | 1.2 | 3.6 |
| SW | 8 | 7 | .1 | | | | | | | | 1.6 | 3.5 |
| WSW | 4 | 4 | 2 | | | | | | | | 1.0 | 3.8 |
| W | 4 | 3 | .1 | | | | | | | | .8 | 3.6 |
| WNW | 2 | 2 | .1 | | | | | | | | .4 | 4.4 |
| NW | | | | | | | | | | | | |
| NNW | 2 | 4 | | | | | | | | | 3 | 5.9 |
| VARBL | | | | | | | | | | | | |
| CALM | | | | | | | | | | | 5.4 | |
| | 6.5 | 23.2 | 44.4 | 19.9 | .6 | | | | | | 100.0 | 7.8 |

TOTAL NUMBER OF OBSERVATIONS 1192

Figure D-10
Surface Winds/Month Sep

MIL-HDBK-1011/2
APPENDIX D (continued)

CLIMATE ANALYSIS SUMMARY WORKSHEET

STEP 1: Station Name: Kaneohe Bay, Hawaii
Data Years: 1973-77, SMOSS / RUSSMO

Prepared By: N.S.W.
Date Prepared: 1/78

STEP 2: Determination of Natural Cooling Strategy

| | Annual % |
|---------------------------------------|----------|
| Comfort (zone 1) | 61.8 |
| Ventilation: 0.5m/s (zones 1 & 2) | 96.6 |
| 1.0m/s (zones 1, 2 & 3) | 99.9 |
| Thermal Mass (zones 1 & 4) | 75.5 |
| Mass + Night Ventilation (z 1, 4 & 5) | 75.5 |
| Evaporative Cooling (zones 1 & 6) | 74.9 |

Monthly % of Best Two Strategies:

| JAN | FEB | MAR | APR | MAY | JUN | JUL | AUG | SEP | OCT | NOV | DEC |
|------|------|------|------|------|------|------|------|------|------|------|------|
| 98.5 | 94.3 | 97.7 | 97.8 | 99.6 | 98.3 | 96.8 | 90.8 | 85.6 | 92.7 | 96.6 | 97.0 |
| 99.6 | 94.8 | 96.1 | 98.1 | 100 | 100 | 99.8 | 99.5 | 99.1 | 99.7 | 99.8 | 97.5 |

STEP 3: Determination of Mechanical Air Conditioning Requirement

Annual % Above Boundary (zone 7): 0.1

Best Strategy: 1.0 m/s

2nd Best Strategy: 0.5 m/s

(If annual % < 5%, then a.c. is not required.)

If annual % > 5%, then a.c. is required, and the building must have TIGHT ENVELOPE. Go to Step 5.

Monthly % Above Strategy Boundary (zone 7):

| JAN | FEB | MAR | APR | MAY | JUN | JUL | AUG | SEP | OCT | NOV | DEC |
|-----|-----|-----|-----|-----|-----|-----|-----|------|-----|-----|-----|
| 0.1 | 0 | 0 | 0.1 | 0 | 0 | 0.2 | 0.5 | 0.9 | 0.3 | 0.2 | 0 |
| 1.2 | 0.5 | 0.6 | 0.6 | 0.6 | 1.7 | 3.2 | 9.3 | 14.6 | 7.1 | 1.7 | 0.5 |

If Monthly percentage > 10%, place an "X" in the monthly square above.

STEP 4: Determination of Infiltration-Resistant Envelope Requirement

% Below 67°F: 0.95

If < 10%, Open Envelope O.K. Go To Step 6.
If > 10%, Infiltration-Resistant Envelope Requirement Can be Examined Monthly to Determine Possible Seasonal Variations:

| JAN | FEB | MAR | APR | MAY | JUN | JUL | AUG | SEP | OCT | NOV | DEC |
|-----|-----|-----|-----|-----|-----|-----|-----|-----|-----|-----|-----|
| | | | | | | | | | | | |

STEP 5: Determination of Heating Requirement

% Below 61°F: 0

If < 10%, No Auxiliary Heating System. Go to Step 6.
If > 10%, Heating Required. Examine Monthly %:

| JAN | FEB | MAR | APR | MAY | JUN | JUL | AUG | SEP | OCT | NOV | DEC |
|-----|-----|-----|-----|-----|-----|-----|-----|-----|-----|-----|-----|
| | | | | | | | | | | | |

If Monthly percentage > 25%, place an "X" in the monthly square above.

STEP 6: Monthly Feasibility of Natural Strategy

If there is an "X" in a square in Steps 3 or 5 above, place an "X" in same month below:

| JAN | FEB | MAR | APR | MAY | JUN | JUL | AUG | SEP | OCT | NOV | DEC |
|-----|-----|-----|-----|-----|-----|-----|-----|-----|-----|-----|-----|
| | | | | | | | | | | | |

Best Strategy: 1.0 m/s
2nd Best Strategy: 0.5 m/s

If the natural cooling strategy works for > 4 months (i.e. 4 or more open squares), include the natural cooling strategy in design. See Sections 3 and 4 for design requirements and recommendations.
If the natural cooling strategy works for < 4 months (i.e. 9 or more "X"s), optional use of the strategy seasonally and/or zonally to reduce loads on mechanical system is recommended.

STEP 7: Determination of Fan Ventilation Requirement

1. If using SMOSS: total time calm and > 81°F:

2. If using RUSSWO: a. Time within ventilation boundary (from STEP 2): 85.6
b. Time above ventilation boundary (from STEP 3): 19.4
c. Time calm (from Part C, Surface Winds): 5.4
d. (% calm) * (within boundary + above boundary): 5.4

If percent time in line 1 or 2d is greater than 10%, then ceiling or whole-house fans must be installed.

Hottest month: Sept.

2nd hottest month: Aug.

| Aug. |
|-------------|
| <u>90.8</u> |
| <u>92.2</u> |
| <u>7.7</u> |

Figure D-11
Climate Analysis Summary Worksheet

MIL-HDBK-1011/2
APPENDIX D (continued)

1.3.1 Results of the Climate Analysis. The results of the climate analysis are shown on the Climate Analysis Summary Worksheet (Figure D-11). In the Kaneohe Bay climate, ventilation is the most suitable strategy for cooling (Step 2). On an annual basis, comfort can be achieved using 197 fpm 1.0 m/sec ventilation for 99.9 percent of the year, and using 98 fpm (0.5 m/sec) ventilation for 96.6 percent of the year. No mechanical air conditioning (Step 3) or heating system (Step 5) is required, and the building envelope does not need to be infiltration resistant (Step 4).

If 0.5 m/sec ventilation is used, only September will have a significant (over 14 percent) uncomfortable period (Step 6). Since smaller window areas will be permitted if 0.5 m/sec ventilation is used (as opposed to 1.0 m/sec), this example will use 0.5 m/sec ventilation as the cooling strategy with ceiling fans providing additional ventilation during September and any times when the outside wind speed is too low for comfort.

1.4 Window Sizing Procedure. Since this is an existing building which is being modified, this example uses the window sizing procedure to check the adequacy of the proposed window sizes (Appendix C, para. 1.1.2) rather than to predict the sizes that should be incorporated into the design. Both of these functions of the window sizing procedure are the same up to Step 15.

(1) Required air velocity rate. $V = \underline{98.5} \text{ fpm} = \underline{0.5} \text{ m/sec}$

From Climate Analysis

(2) Cross-sectional area of the room, CS
Height of room, H $H = \underline{8.5} \text{ ft}$
Width of room across flow, W $W = \underline{9.5} \text{ ft}$
CS = H * W $CS = \underline{80.75} \text{ft}^2$

(3) Required airflow rate, CFM.
CFM = V x CS $CFM = \underline{7953.8} \text{cfm}$

(4) Building location = Kaneohe Bay, HI (city)
Weather Station location = Kaneohe Bay, HI
From: Climate Analysis--examine worst two naturally ventilated months separately.

Design months: Sept. / August

Prevailing wind direction for month, WD. $WD = \underline{ENE} / \underline{ENE}$

(a) OPTION 1: MOS Part E--"Temperature vs. Wind Direction". Pick predominant wind direction associated with the 82deg.F to

86deg.F

band for the month.

(b) OPTION 2: If no SMOS exists for the location, use RUSSWO Part C--"Surface Winds." Pick predominant wind direction for month.

(6) Wind speed for month, WS. $WS = \underline{9.5} \text{ kn} = \underline{10.3} \text{ kn}$
From: SMOS or RUSSWO Part C--"Surface Winds."
Pick mean wind speed corresponding to direction chosen in Step 5 for the month.

MIL-HDBK-1011/2
APPENDIX D (continued)

- (7) Incidence angle, alpha, on windward face, alpha = 47.5deg = 47.5deg
from site plan and prevailing
wind direction (see Figure C-2).
- (8) From Table C-1 or C-2 determine: (used 45deg.)
- (a) Windward pressure coefficient, WPC WPC = +0.6 = +0.6
- (b) Leeward pressure coefficient, LPC LPC = -0.5 = -0.5
- (9) Pressure coefficient differential, PCD. PCD = 1.1 = 1.1
PCD = WPC - LPC
- (10) For the surrounding neighborhood and the PCCF = 0.61 = 0.61
proposed building type, determine from
Table C-3 the pressure coefficient
correction factor, PCCF.
Bldg type No. 5 h = 23 ft g = 65 ft
h/g = 2.8
- (11) Calculate the revised pressure PD = 0.67 = 0.67
coefficient differential, PD
PD = PCD * PCCF
- (12) Obtain terrain correction factor, TCF, TCF = 0.85 = 0.85
from Table C-4.
Terrain type suburban
- (13) Compute revised meteorological wind speed W = 817 fpm = 886fpm
fpm in feet per minute, W.
W = WS * TCF * 101.2
- (14) Calculate required open effective A = 18.5ft² = 17.0 ft²
window area, A.
A = (1.56 * CFM) / [W * (PD)^{1/2}]
- (15) Calculate the inlet window area for the W_i = 72 ft² = 72ft²
proposed design, W_i .
- (16) Correct using resistance factor, RF_i , RF_i = 0.56 = 0.56
type, screens, etc., from Table C-5.
- (17) Calculate the effective open inlet A_i = 40 ft² = 40ft²
area, A_i .
A_i = W_i * RF_i
- (18) Calculate required open outlet area, A_o. A_o = 21 ft² = 19ft²
A_o = A x A_i / [(A_i² - A²)/2]
- (19) Calculate the outlet window area for the W_o = 40 ft² = 40 ft²
proposed design, W_o.

MIL-HDBK-1011/2
APPENDIX D (continued)

- (20) Find the resistance factor, RF_o , $RF_o = \underline{0.56} = \underline{0.56}$
for the outlet openings from Table C-5.
- (21) Calculate the effective outlet opening, $A_e = \underline{22.4} \text{ ft}^2 = \underline{22.4} \text{ ft}^2$
 A_e .
 $A_e = W_o * RF_o$.
- (22) Compare the required outlet opening with the effective outlet opening.

Worst Month: September 2nd worst month: August

$$A_o = \underline{21}$$

$$A_o = \underline{19}$$

$$A_e = \underline{22.4}$$

$$A_e = \underline{22.4}$$

If $A_o < A_e$ then the required airspeed will be obtained and comfort can be expected.

If $A_o > A_e$ then the required airspeed will not be obtained.

1.4.1 Results of the Window Sizing Procedure. The procedure was performed for the months of August and September. The required open effective window area (Step 14) is 17.1 ft² (1.6 m²) in August and 18.5 ft² in September. Assuming fly screens of 14 strands per in. (porosity 0.8), and that the window wall consists of fixed louvers for the lower four feet (porosity = 0.6) and operable louvers for the upper four feet (porosity = 0.8), the required open outlet area (step 18) is 19 ft² in August and 21 ft² in September. The actual effective outlet area based on the proposed design (Step 20) is 22.4 ft². Since the actual effective outlet area is greater than the required outlet area, it can be expected that the design will be capable of producing 0.5 m/sec ventilation in the rooms and will be comfortable for all months except for about 14 percent of September.

Ceiling fans producing 197 fpm (1.0 m/sec) ventilation for a substantial area within the room will provide comfortable conditions during the periods when the outside wind speed is too low and during heavy rains. These ceiling fans would also provide comfort during the 14 percent overheated period of September.

MIL-HDBK-1011/2

GLOSSARY

Absorption. The conversion of radiation impinging on a material's surface to thermal energy within the material. All radiation incident on opaque materials is either absorbed or reflected.

Bioclimatic chart. A diagram of temperature, humidity, radiation, and air movement used to display the human comfort zone under a wide range of environmental conditions.

Bodily cooling. Any means of using climate elements to cool the occupant directly. Natural ventilation directed across the human body may cool it by increasing convective and evaporative heat loss from the skin. Bodily cooling is distinct from structural cooling.

British thermal unit (Btu). The amount of heat required to raise the temperature of one pound of water by one degree F.

Building bioclimatic chart. An expansion of the bioclimatic chart in which the limits for well-developed executions of climate control strategies are plotted in addition to the comfort zone.

Clo. A unit of measurement used to describe clothing insulation level. One clo is equivalent to $0.155 \text{ m}^2 \cdot (\text{deg.C})/\text{watts}$.

Comfort. see Thermal comfort.

Conditioned and unconditioned spaces. The need for air treatment such as heat addition, heat removal, moisture removal or pollution removal for a space, vs. the lack of need for such air conditioning in a space.

Conductivity. A measure of heat energy transfer through solids caused by a difference in temperature.

Dewpoint temperature (DP). The temperature at which a given concentration of moisture in the air begins to condense. The dewpoint temperature of any temperature and humidity combination is found on the psychrometric chart at the left end of the horizontal line passing through that temperature and humidity combination.

Direct gain. Solar heat liberated within the building after passing through glazing.

Direct radiation. Shortwave radiation that has travelled a straight path (without refraction or reflection) from the sun to the earth's surface.

Diurnal swing. The difference between maximum day and minimum night temperatures.

Dry-bulb temperature. A measure of sensible heat as read on a standard thermometer and indicated on the psychrometric chart by vertical lines.

MIL-HDBK-1011/2

Envelope-dominated buildings. A building in which the loads created by the external conditions are greater than the loads created by internal sources.

Fenestration. The design or placement of windows in a building.

First-order weather station. A major weather station at which a full set of surface observations are taken on an hourly or three-hourly basis.

Heat capacity. The ability of a material to store heat for a given change in its temperature. Among building materials, dense materials have high heat capacities.

Humidity ratio (W). For any temperature and humidity combination, the ratio of the mass of water vapor to the mass of the dry air with which it is mixed. It is shown on the horizontal lines of the psychrometric chart and read along the right-hand vertical axis. It is also known as absolute humidity.

Infiltration. Unwanted air exchange between the building interior and exterior, resulting from pressures caused by wind and interior-exterior temperature differentials. The primary difference between the usual definitions of infiltration and ventilation is that infiltration is undesirable and uncontrolled, whereas ventilation is desirable and controllable.

Infiltration-resistant envelope. A building envelope designed to limit air changes to less than 0.5 per hour. An infiltration-resistant envelope is required in buildings that have mechanical air conditioning or heating systems, and in climates where the temperatures drop low enough that unrestricted air movement would cause uncomfortably low conditions within the building.

Insulation. Capacity of materials to retard heat flow.

Life-cycle cost (LCC) analysis. The total cost of a system over its economically useful life. It includes the appropriate summation of all costs expected to be incurred as a result of choosing and implementing any particular plan or design over the life of the facility.

Load. The energy required within a building space to maintain interior environmental conditions.

Mean radiant temperature. The uniform surface temperature of an imaginary black enclosure that exchanges the same heat by radiation as the actual non-uniform environment.

Met. A unit of human metabolic rate. One met is equivalent to 58 watts/m.² of body surface, or 50 kcal/h*m.² of body surface, or 18.4 Btu/h*ft.² of body surface.

Natural cooling strategy. A method for building cooling that does not use purchased energy sources.

MIL-HDBK-1011/2

Night sky radiation. This term is usually used to refer to the loss of long-wave radiant energy from relatively warm building surfaces to the cooler sky. The loss is greatest on clear nights when there is little water vapor in the atmosphere to intercept the outgoing radiation.

Normal. When referring to direction (as of wind), this term means "perpendicular" or "at right angles."

Operative temperature. The uniform temperature of an imaginary enclosure with which man will exchange the same dry heat by radiation and convection as with the actual environment.

Passive system. A system that uses non-mechanical means to satisfy space loads.

Pressure coefficient. The ratio of the pressure on a building surface to the pressure of wind brought to a halt on the windward face of a flat plate. This latter pressure is the maximum pressure to be extracted from the force of the wind, and is also known as the 'stagnation pressure'.

Psychrometric Chart. A graphic representation of air temperature and humidity relationships on a chart.

R-value. A measure of building insulation, or resistance to heat flow driven by temperature differences. The higher the R-value, the better the resistance to heat flow. R-values for building materials, air spaces, air films, etc. are established and used to calculate the overall thermal resistance of building envelope components such as walls and roofs.

Reflectivity (albedo). The ratio of reflected radiation to received radiation. Reflectivities differ for shortwave (solar) and longwave (terrestrial) radiation.

Relative humidity (RH). The ratio of vapor pressure in an air-water mixture to vapor pressure at saturation (the dew point temperature). RH is plotted on the psychrometric chart as curved lines from lower left to upper right.

Revised Uniform Summary of Surface Weather Observations (RUSSWO). A weather summary distributed by the National Climatic Center containing detailed summaries of different weather variable for numerous weather station worldwide. A revision of the SMOS summary.

Second-order weather station. Minor weather stations at which a limited number of climatic variables are collected daily. Climatic data from such stations are presented primarily as monthly means and extremes.

Shelter effect. A phenomenon in which the air speeds on the leeward side of an obstruction are lower than those of the free stream due to the influence of the obstruction on the airflow.

Solar altitude. The vertical angle between the sun's position in the sky and a horizontal plane. The angle is lowest at winter solstice and highest at summer solstice.

MIL-HDBK-1011/2

Solar angle of incidence. The angle that the rays of the sun make with a line perpendicular to a surface. It determines the percentage of direct sunshine intercepted by that surface.

Solar azimuth. The horizontal angle between the sun's bearing and a north-south line projected on a horizontal plane. The sun passes the horizon at a different point each day. The arc of the sun is smaller in winter, larger in summer.

Stack effect. The movement of air into and out of a space due to temperature differences. When the temperature is higher inside, differences in air density produce a negative inside pressure and inward air flow at low levels within the space, and a positive inside pressure and outward air flow at high levels within the space.

Structural cooling. Cooling of the building structure directly rather than the body of the occupant. Structural cooling by natural ventilation involves directing air flow across the building's interior surfaces to remove heat stored in the building. This in turn can cool occupants indirectly.

Summary of Meteorological Observations, Surface (SMOS). A weather summary distributed by the National Climatic Center containing detailed summaries of numerous weather variables for numerous weather station worldwide.

Thermal comfort. A state in which the human body is in thermal equilibrium with its surroundings. Major factors are. air temperature, surrounding surface temperatures, humidity, solar radiation, air movement, clothing level and activity level.

Thermal capacity. See Heat Capacity.

Thermal mass. The heat capacity of a given mass or volume of material. Commonly used to describe the heat absorption and retention of massive building elements.

Turbulence. The fluctuating component of wind velocity. Experienced as gusts or passing eddies.

Ventilation. Airflow through and within an internal space stimulated by two means: 1) the distribution of wind pressure gradients around a building and 2) pressure differences caused by temperature gradients between indoor and outdoor air.

Wake. The area of turbulent air directly to the leeward side of an obstruction.

Wet-bulb temperature. The temperature of a thermometer bulb covered with a wet wick and exposed to moving air. It is a measure of the moisture content of the air. On the psychrometric chart it is plotted as lines sloping downward from left to right and labelled at the upper left.

Wingwall. A projection from the building facade that may act to direct wind or provide shading.

MIL-HDBK-1011/2

Zoning. A building configuration in which some areas are separated from other areas to meet a programmatic requirement. In naturally ventilated zoned buildings, this often results in a building which has a naturally ventilated section and a separate air conditioned section.

MIL-HDBK-1011/2

PAGE 154 INTENTIONALLY LEFT BLANK

MIL-HDBK-1011/2

REFERENCES

NOTE: Unless otherwise specified in the text, users of this handbook should utilize the latest revisions of the documents cited herein.

FEDERAL/MILITARY SPECIFICATIONS, STANDARDS, BULLETINS, HANDBOOKS, AND NAVFAC GUIDE SPECIFICATIONS:

The following handbooks form a part of this document to the extent specified herein. Unless otherwise indicated, copies are available from Commanding Officer, Naval Publications and Forms Center, ATTENTION: NPODS, 5801 Tabor Avenue, Philadelphia, PA 19120-5099.

MILITARY HANDBOOKS

| | |
|-----------------|------------------------------------|
| MIL-HDBK-1001/2 | Materials and Building Components |
| MIL-HDBK-1190 | Facility Planning and Design Guide |

NAVY MANUALS, DRAWINGS, P-PUBLICATIONS, AND MAINTENANCE OPERATING MANUALS:

Available from Commanding Officer, Naval Publications and Forms Center (NPFC), 5801 Tabor Avenue, Philadelphia, PA 19120-5099. To Order these documents: Government agencies must use the Military Standard Requisitioning and Issue Procedure (MILSTRIP); the private sector must write to NPFC, ATTENTION: Cash Sales, Code 1051, 5801 Tabor Avenue, Philadelphia, PA 19120-5099.

DESIGN MANUALS

| | |
|-------------|---|
| DM-1 Series | Architecure |
| DM-3 Series | Mechanical Engineering |
| DM-3.03 | Heating, Ventilating, Air Conditioning, and Dehumidifying Systems |

P-PUBLICATIONS

| | |
|--------------|----------------------------|
| NAVFAC P-442 | Economic Analysis Handbook |
|--------------|----------------------------|

HANDBOOKS

| | |
|----------------|---|
| NCEL CR 83.005 | Handbook of Thermal Insulation Applications |
|----------------|---|

MIL-HDBK-1011/2

NAVY DEPARTMENTAL INSTRUCTIONS: Available from Commanding Officer, Naval Publications and Forms Center, ATTENTION: Code 3015, 5801 Tabor Avenue, Philadelphia, PA 19120-5099.

NAVFACINST 4100.5A Design Criteria Guidance for Energy

OTHER GOVERNMENT DOCUMENTS AND PUBLICATIONS:

The following Government documents and publications form a part of this document to the extent specified herein.

U.S. AIR FORCE Revised Uniform Summary of Surface Weather Observations (RUSSWO)

(Unless otherwise indicated, copies are available from National Climatic Data Center (NCDC), Federal Building, Ashville, NC, 28801-2696, commercial telephone (704) 259-0682 or (704) 259-0871.

U.S NAVY Summary of Meteorological Observations, Surface (SMOS), "Part C"--Surface Winds

(Unless otherwise indicated, copies are available from Naval Oceanography Command Detachment (NOCD), Officer in Charge, Federal Building, Ashville, North Carolina 28801-2696; commercial telephone (704) 252-7865; FTS 259-0232.

NON-GOVERNMENT PUBLICATIONS

The following publications form a part of this document to the extent specified herein. Unless otherwise specified, the issues of the documents which are DOD adopted are those listed in the Department of Defense Index of Specification & Standards (DODISS).

Chandra, S. "A Design Procedure to Size Windows for Naturally Ventilated Rooms": Proceedings of the ASES Passive Solar Energy Conference, Glorieta, New Mexico, (November 1983), pp. 105-110.

Chandra, S., Ruberg, K., and Kerestecioglu, A. "Outdoor Testing of Small Scale Naturally Ventilated Models": Building and Environment, Vol. 18, No. 1-2 (1983), pp. 45-53.

Gagge, A.P.; Stolwijk, J.A.J.; and Nishi, Y. "An Effective Temperature Scale Based on a Simple Model of Human Physiological Regulator Response", ASHRAE Transactions, Part 1, Vol. 70 (1970).

Koenigsberger, O.; Miller, J.S; and Costopolous, J. "Window and Ventilator Openings in Warm and Humid Climates", Architectural Science Review (July 1959), pp. 82-94.

MIL-HDBK-1011/2

Vickery, B.J. "The Use of the Wind Tunnel in the Analysis of Naturally Ventilated Structures", Proceedings of the International Passive and Hybrid Cooling Conference, American Solar Energy Society, Miami Beach (1981), pp. 728-742.

AMERICAN INSTITUTE OF ARCHITECTS

Architectural Graphic Standards

Climate and Architecture Conference Handbook

(Unless otherwise indicated, copies are available from the American Institute of Architects, 1735 New York Avenue, NW, Washington, DC 20006 (202) 626-7300.

AMERICAN SOCIETY OF HEATING, REFRIGERATING AND AIR-CONDITIONING ENGINEERS (ASHRAE)

ASHRAE Handbook of Fundamentals

Standard 55 Thermal Environmental Conditions for Human Occupancy

Standard 62 Ventilation for Acceptable Indoor Air Quality

(Unless otherwise indicated, copies are available from the American Society of Heating, Refrigerating and Air-Conditioning Engineers, 1791 Tullie Circle, NE, Atlanta, Georgia 30329, (404) 636-8400.

MIL-HDBK-1011/2

PAGE 158 INTENTIONALLY LEFT BLANK

MIL-HDBK-1011/2

BIBLIOGRAPHY

American Society of Civil Engineers. "Wind Forces On Structures--Final Report of the Task Committee on Wind Forces of the Committee on Loads and Stresses of the Structural Division": ASHRAE Transactions, Vol. 126, Part II (1961), p. 1124.

American Society of Civil Engineers Aerodynamic Committee. Proposed Manual of Practice for Wind Tunnel Testing of Buildings and Structures: Draft presented at the 1983 Annual ASCE Convention, Houston, Texas.

American Society of Heating, Refrigerating and Air-Conditioning Engineers. ASHRAE Handbook of Fundamentals: ASHRAE, Atlanta, Georgia (1981).

Arans, E.A. "Designing for an Acceptable Wind Environment": Transportation Engineering Journal of the ASCE, Vol. 107, no. TE2 (March 1981), pp. 127-141.

Arans, E.A.; Blyholder, A.G. and Schiller, G.E. "Predicting Thermal Comfort of People in Naturally Ventilated Buildings": ASHRAE Transactions, Preprint AT-84-05, Vol. 90, no. 4, Part 1 (1984).

Arans, E.A., Flynn; McNall, L.E.; and Ruberg, D.N. Geographical Extrapolation of Typical Hourly Weather Data for Energy Calculation in Buildings: NBS Building Science Series no. 126. U.S. Department of Commerce--National Bureau of Standards, Washington, D.C. (1980), 124 p.

Arans, E.A.; Gonzalez; Berglund; McNall, L.E.; and Zeren. "A New Bioclimatic Chart for Passive Solar Design", Proceedings of the 5th National Passive Solar Conference, American Solar Energy Society, Vol. 5.2 (1980), pp. 1202-1206, Golden, Colorado.

Arans, E.A., and Williams. "Wind and Building Energy Consumption--An Overview": ASCE Preprint no. 81-128, American Society of Civil Engineers, New York (May 11-15, 1981).

Ashley, S.K. "Natural Ventilative Cooling of Buildings": NCEL Technical Report R-917, National Civil Engineering Laboratory, Port Hueneme, CA, (January 1986).

Aynsley, R.M. "Wind-Generated Natural Ventilation of Housing for Thermal Comfort in Hot Humid Climates": Preprints of the 5th International Conference on Wind Engineering, Vol. 1, Sessions I-V, Colorado State University, Fort Collins, Colorado (1979), pp. III-3-1.

Aynsley, R.M. "Estimating Comfort from Natural Wind Inside Buildings Using Boundary Layer Wind Tunnels": ASHRAE Transactions, Vol. 92, Part 2, ASHRAE, Atlanta, Georgia (1985).

Aynsley, R.M.; Melbourne, W.; and Vickery, B.J. Architectural Aerodynamics: Applied Science Publishers, Ltd., London, England (1977).

Baltaxe, R. "Air Flow Patterns in the Lee of Model Windbreaks": Archiv fur

MIL-HDBK-1011/2

Meteorologie Geophysik und Bioklimatologie, Serie B, Band 15, Heft 3 (1967), pp. 287-312.

Birch, Tony. "Back to the Fan": Rodale's New Shelter (July/August 1980), pp. 29-32.

Brown, G.Z. Sun, Wind and Light--Architectural Design Strategies: John Wiley and Sons, New York (1985).

Building Research Station. "The Assessment of Wind Loads": Building Research Station Digest, Vol. 119 (July 1970), pp. 1-12.

Chandra, S.; Fairey, P.; and Houston, M. A Handbook for Designing Ventilated Buildings, Final Report: U.S. Department of Energy, Florida Solar Energy Center, Florida (September 23, 1983).

Chandra, S.; Fairey, P.; Houston, M.; and Kerestecioglu, A. "Wingwalls to Improve Natural Ventilation--Full-Scale Results and Design Strategies": Passive Solar Journal, Vol. 2, no. 2 (1983), pp. 116-122.

Cermak, J.E.; Poreh, M.; Peterka, J.A.; and Ayad, S.S. "Wind Tunnel Investigations of Natural Ventilation": American Society of Civil Engineers Convention and Exhibit, New Orleans, LA, Preprint 82-519 (October 1982).

Dean, Edward. Energy Principles in Architectural Design: California Energy Commission, Sacramento, California (1981).

Evans, Benjamin. "Natural Airflow Around Buildings": Research Report no. 59, Texas Engineering Experiment Station, College Station, Texas, (1957).

Evans, Martin. Housing, Climate and Comfort: The Architectural Press, London, England (1980).

Fairey, Philip. "Radiant Barriers for Cooler Houses", Solar Age, Vol. 9, no. 7 (July 1984), pp. 34-39.

Fanger, P.O. 1982. Thermal Comfort, Analysis and Applications in Environmental Engineering: Robert E. Krieger Publishing Co., Inc., Malabar, Florida, (Reprinted 1982).

Fry, M. and Drew, J. 1982. Tropical Architecture in the Dry and Humid Zones (Second Edition): Robert E. Krieger Publishing Co., Inc., Malabar, Florida (1982).

Gandemer, J. 1975. "Wind Environment Around Buildings--Aerodynamic Concepts": Proceedings of the Fourth International Conference on Wind Effects on Buildings and Structures, London, England.

Geiger, R. 1965. The Climate Near the Ground: Harvard University Press, Cambridge, MA.

Givoni, B. Man, Climate, and Architecture (Second Edition): Van Nostrand Reinhold Company, New York (1981).

MIL-HDBK-1011/2

Hastings and Crenshaw. Window Design Strategies to Conserve Energy: NBS Building Science Series 104, Architectural Research Section, Center for Building Technology, Institute for Applied Technology, National Bureau of Standards, Washington, D.C. (June 1977).

Holleman, T.R. "Air Flow Through Conventional Window Openings": Research Report, Texas Engineering Experiment Station, College Station, TX (1951).

Koenigsberger, O; Ingersoll; Mayhew; and Szokolay. Manual of Tropical Housing and Building, Part 1--Climate Design: Longman Group Ltd., London, England (1973).

Koenigsberger, O.; Mahoney; and Evans. Design of Low-Cost Housing and Community Facilities, Vol. 1--Climate and Housing Design: United Nations, New York (1971).

Konya, A. Design Primer for Hot Climates. The Architectural Press, Ltd., London, England (1980).

Lee, Hussain, and Soliman. "Predicting Natural Ventilation Forces Upon Low-Rise Buildings": ASHRAE Journal (February 1980), pp. 35-39.

Naval Oceanography Command Detachment, (NOCD). Guide to Standard Weather Summaries and Climatic Services: NAVAIR 50-1C-534, Asheville, N.C. (January 1980).

Olgay, V. Design with Climate--Bioclimatic Approach to Architectural Regionalism: Princeton University Press, Princeton, New Jersey (1963).

Robinette, G. O. Energy Efficient Site Design. Van Nostrand Reinhold Co., New York (1983).

Robinette, G. O. Plants, People, and Environmental Quality--A Study of Plants and their Environmental Functions: U.S. Dept. of the Interior, Washington, D.C. (1972).

Schubert, R.P. and Kennedy, B. "The Testing of Full Scale Ventilator Cap Types to Determine their Effect on Natural Ventilation": Proceedings of the International Passive and Hybrid Cooling Conference, American Solar Energy Society, Miami Beach (1981), pp. 201-205.

Simiu, Emil. Wind Engineering--A State of the Art Review: Center for Building Technology, National Engineering Lab, National Bureau of Standards, Washington, D.C. (1981).

Sobin, H. "Window Design for Passive Ventilative Cooling--An Experimental Model-Scale Study": Proceedings of the International Passive and Hybrid Cooling Conference, American Solar Energy Society, Miami Beach (1981).

Task Committee on Control of Microclimate Around Buildings. "Control of the Wind Climate Around Buildings": Journal of Transportation Engineering, Vol. 110, no. 5 (September 1984), pp. 493-505.

MIL-HDBK-1011/2

Warren, P.R. 1977. "Ventilation Through Openings on One Wall Only": Building Research Establishment, pp. 189-205.

Watson, D. and Labs, K. Climatic Design--Energy Efficient Building Principles and Practices: McGraw-Hill Book Company, New York (1983).

White, Robert. "Landscape Development and Natural Ventilation--Effect of Moving Air on Buildings and Adjacent Areas": Landscape Architecture, Vol. XLV [45], no. 2 (January 1955), pp. 72-81.

Wise, A.F.E., Sexton, D.E., and Lillywhite, M.S.T. Studies of Air Flow Around Buildings: Architects Journal Information Library, Vol 19 (May 1965), pp. 1185-1189.

CUSTODIAN
NAVY - YD

PREPARING ACTIVITY
NAVY - YD

PROJECT NO.
FACR-0216